

### Typical Applications

The HMC221A(E) is ideal for:

- ISM Applications
- PCMCIA Wireless Cards
- Cellular Applications

### Functional Diagram

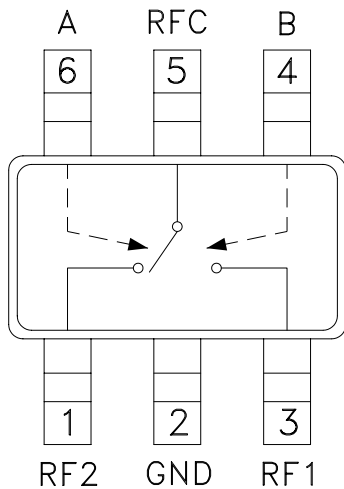

### Features

- RoHS-Compliant Product
- Low Insertion Loss: 0.4 dB
- Ultra Small Package: SOT26
- Input IP3: +45 dBm
- Positive Control: 0/+3V @ 3  $\mu$ A
- Included in the HMC-DK005 Designer's Kits

### General Description

The HMC221A(E) is a low-cost SPDT switch in a 6-lead SOT26 plastic package for use in general switching applications which require very low insertion loss and very small size. This device can control signals from DC to 3 GHz and is especially suited for 900 MHz, 1.8 - 2.2 GHz, and 2.4 GHz ISM applications with less than 1 dB loss. The design provides exceptional insertion loss performance, ideal for filter and receiver switching. RF1 and RF2 are reflective shorts when "Off". The two control voltages require a minimal amount of DC current and offer compatibility with most CMOS & TTL logic families. See HMC197A(E) for same performance in an alternate SOT26 pin-out.

### Electrical Specifications, $T_A = +25^\circ \text{C}$ , $V_{ctl} = 0/+3$ to $+8 \text{Vdc}$

Parameter	Frequency	Min.	Typ.	Max.	Units
Insertion Loss	DC - 1.0 GHz		0.4	0.7	dB
	DC - 2.0 GHz		0.45	0.8	dB
	DC - 2.5 GHz		0.6	0.9	dB
	DC - 3.0 GHz		0.8	1.1	dB
Isolation	DC - 1.0 GHz	24	28		dB
	DC - 2.0 GHz	24	28		dB
	DC - 2.5 GHz	21	25		dB
	DC - 3.0 GHz	14	18		dB
Return Loss	DC - 1.0 GHz	20	23		dB
	DC - 2.0 GHz	17	22		dB
	DC - 2.5 GHz	16	20		dB
	DC - 3.0 GHz	11	15		dB
Input Power for 1 dB Compression ( $V_{ctl} = 0/+5\text{V}$ )	0.5 - 1.0 GHz	25	30		dBm
	0.5 - 3.0 GHz	23	29		dBm
Input Third Order Intercept ( $V_{ctl} = 0/+5\text{V}$ ) (Two-tone Input Power = +7 dBm Each Tone)	0.5 - 1.0 GHz	40	45		dBm
	0.5 - 3.0 GHz	38	43		dBm
Switching Characteristics	DC - 3.0 GHz	$t_{RISE}, t_{FALL}$ (10/90% RF)	3		ns
		$t_{ON}, t_{OFF}$ (50% CTL to 10/90% RF)	10		ns



### Insertion Loss

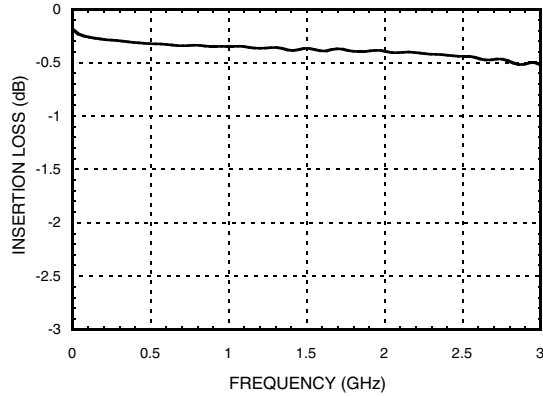

### Isolation

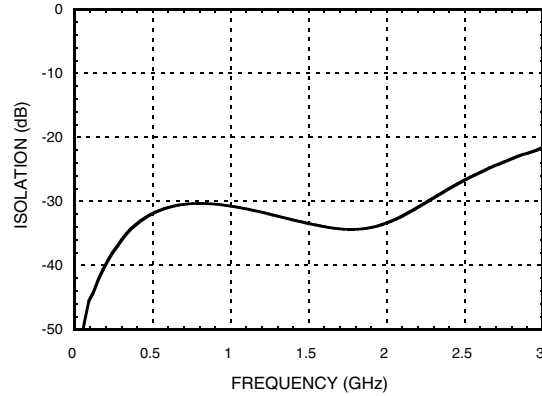

### Return Loss

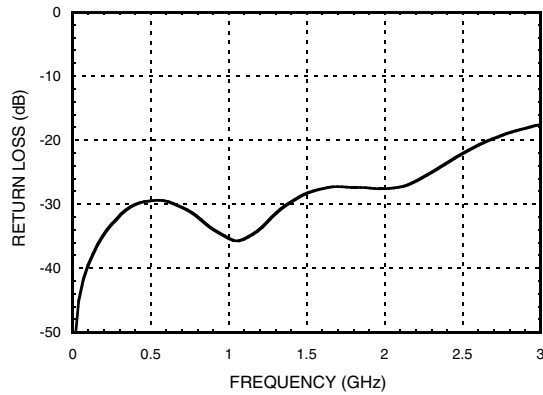

### Input 0.1 and 1.0 dB Compression vs. Control Voltage

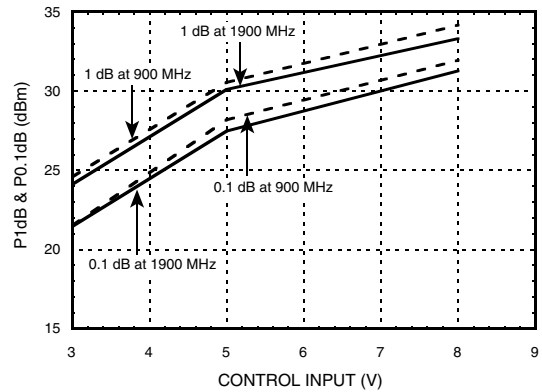

### Input Third Order Intercept Point vs. Control Voltage

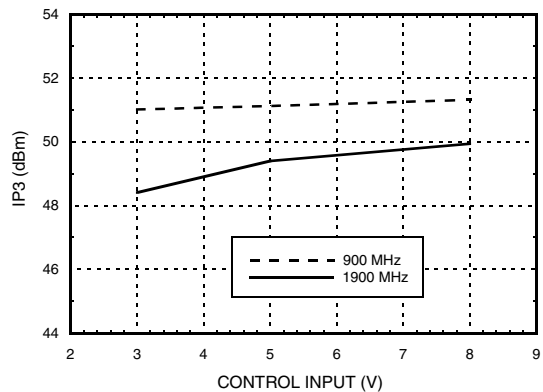

### Distortion vs. Control Voltage

Control Input (Vdc)	Third Order Intercept (dBm) +7 dBm Each Tone	
	900 MHz	1900 MHz
+3	51	48
+5	51	49
+8	51	50

### Truth Table

\*Control Input Voltage Tolerances are ± 0.2 Vdc.

Control Input*		Control Current		Signal Path State	
A (Vdc)	B (Vdc)	Ia (µA)	Ib (µA)	RF to RF1	RF to RF2
0	+3	-3	3	ON	OFF
+3	0	3	-3	OFF	ON
0	+5	-5	5	ON	OFF
+5	0	5	-5	OFF	ON
0	+8	-32	32	ON	OFF
+8	0	32	-32	OFF	ON

### Compression vs. Control Voltage

Control Input (Vdc)	Carrier at 900 MHz		Carrier at 1900 MHz	
	Input Power for 0.1 dB Compression (dBm)	Input Power for 1 dB Compression (dBm)	Input Power for 0.1 dB Compression (dBm)	Input Power for 1.0 dB Compression (dBm)
+3	21	24	21	24
+5	28	30	27	30
+8	32	34	31	33

Caution: Do not operate in 1dB compression at power levels above +31 dBm (Vctl = +5 Vdc) and do not "hot switch" power levels greater than +20 dBm (Vctl = +5Vdc). DC blocks are required at ports RF2, RF1 and RF2.

### Absolute Maximum Ratings

Control Voltage Range (A & B)	-0.2 to +12 Vdc
Channel Temperature	150 °C
Continuous P <sub>diss</sub> (T = 85 °C) (derate 5.6 mW/°C above 85 °C)	0.36 W
Thermal Resistance	178 °C/W
Storage Temperature	-65 to +150 °C
Operating Temperature	-40 to +105 °C
ESD Sensitivity (HBM)	Class 1A



**ELECTROSTATIC SENSITIVE DEVICE  
OBSERVE HANDLING PRECAUTIONS**

### Outline Drawing

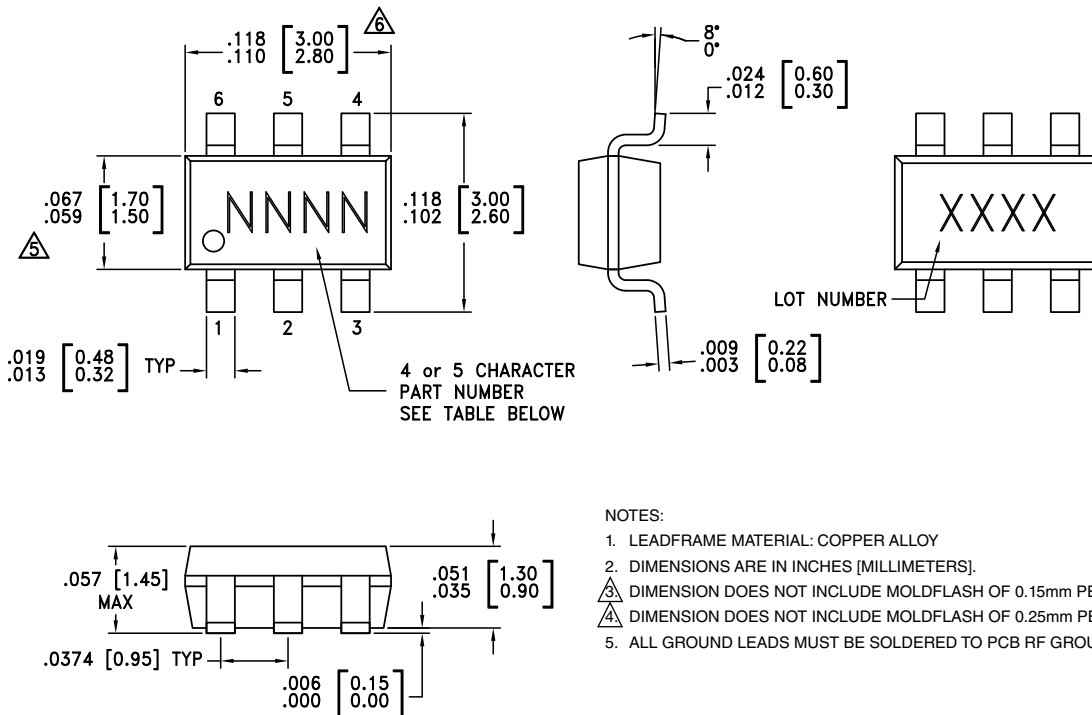

### Package Information

Part Number	Package Body Material	Lead Finish	MSL Rating	Package Marking
HMC221A	Low Stress Injection Molded Plastic	Sn/Pb Solder	MSL1 [1]	221A XXXX
HMC221AE	RoHS-compliant Low Stress Injection Molded Plastic	100% matte Sn	MSL1 [2]	221AE XXXX

[1] Max peak reflow temperature of 235 °C

[2] Max peak reflow temperature of 260 °C

### Typical Application Circuit

Notes:

1. Set logic gate and switch Vdd = +3V to +5V and use HCT series logic to provide a TTL driver interface.
2. Control inputs A/B can be driven directly with CMOS logic (HC) with Vdd of 5 to 8 Volts applied to the CMOS logic gates.
3. DC Blocking capacitors are required for each RF port as shown. Capacitor value determines lowest frequency of operation.
4. Highest RF signal power capability is achieved with Vdd = +8V and A/B set to 0/+8V.

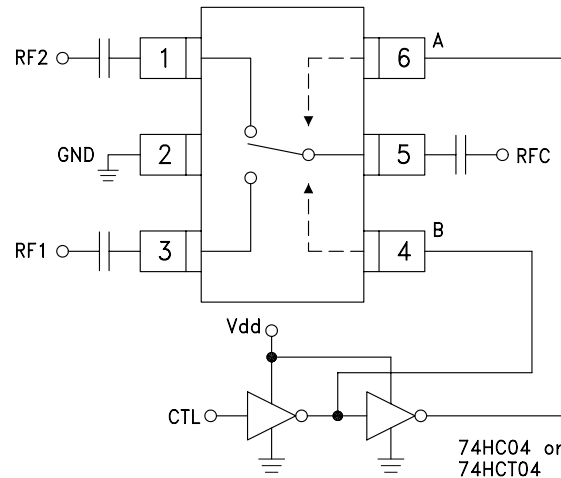

### Evaluation Circuit Board

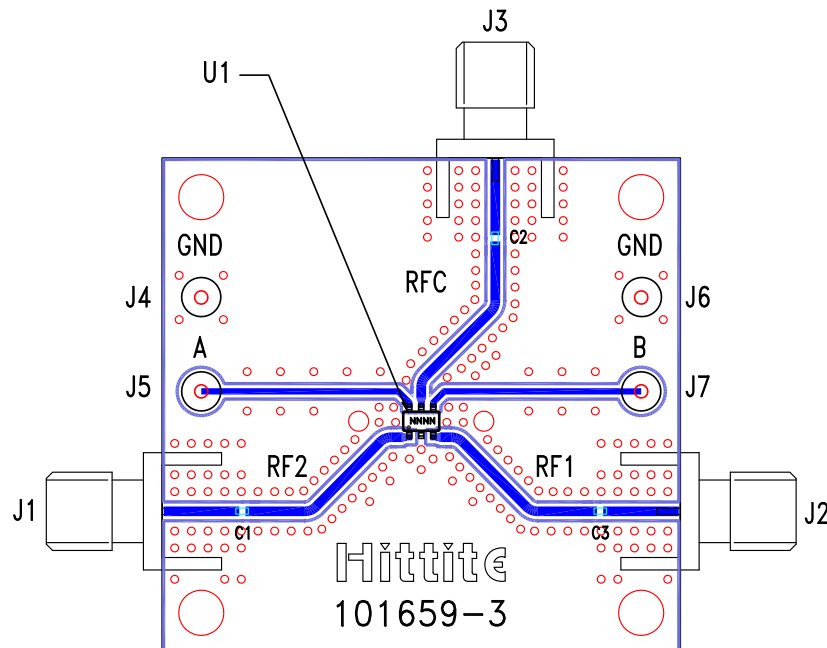

### List of Materials for Evaluation PCB 101675 [1]

Item	Description
J1 - J3	PCB Mount SMA RF Connector
J4 - J7	DC Pin
C1 - C3	330 pF Capacitor, 0402 Pkg.
U1	HMC221A / HMC221AE SPDT Switch
PCB [2]	101659 Evaluation PCB

[1] Reference this number when ordering complete evaluation PCB

[2] Circuit Board Material: Rogers 4350

The circuit board used in the application should be generated with proper RF circuit design techniques. Signal lines at the RF port should have 50 Ohm impedance and the package ground leads and package bottom should be connected directly to the ground plane similar to that shown above. The evaluation circuit board shown above is available from Hittite Microwave Corporation upon request.