

Broadband Low Noise Amplifier 0.05 - 4 GHz

Rev. V2

Features

- 19 dB flat Broadband Gain to 3.25 GHz
- Low Noise Figure:
 - 1.3 dB @ 1.2 GHz
 - 1.8 dB @ 3.25 GHz
- High Linearity OIP3:
 - 36 dBm @ 1.2 GHz
 - 33 dBm @ 3.25 GHz
- Internal Matching to 50 Ω
- Single Voltage Bias: 3 - 5 V
- Integrated Active Bias Circuit
- Current Adjustable 20 - 120 mA
- Lead-Free 2 mm 8-Lead PDFN Package
- Halogen-Free "Green" Mold Compound
- RoHS* Compliant
- Power Down Option

Description

The MAAM-011229 is a broadband high dynamic range, single stage MMIC LNA assembled in a lead-free 2 mm 8 Lead PDFN plastic package. The amplifier is internally matched to provide flat gain and excellent return losses to 3.25 GHz without any external matching components. Use of external matching could extend usable frequency range beyond 4 GHz.

This low noise amplifier has an integrated active bias circuit allowing direct connection to 3 V or 5 V bias and minimizing variations over temperature and process. The bias current can be adjusted with an optional external resistor, so the user can customize the power consumption to fit the application. I_{ADJ} pin can be utilized as an enable pin to power the device up and down during operation.

Ordering Information^{1,2}

Part Number	Package
MAAM-011229-TR1000	1000 piece reel
MAAM-011229-TR3000	3000 piece reel
MAAM-011229-SMB	Sample Board

1. Reference Application Note M513 for reel size information.
2. All sample boards include 5 loose parts.

*Restrictions on Hazardous Substances, European Union Directive 2011/65/EU.

Functional Block Diagram

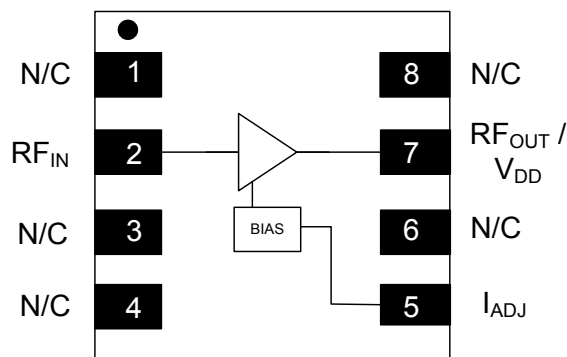

Pin Configuration³

Pin No.	Pin Name	Description
1	N/C	No Connection
2	RF_{IN}	RF Input
3	N/C	No Connection
4	N/C	No Connection
5	I_{ADJ}	Bias Current Adjust
6	N/C	No Connection
7	RF_{OUT} / V_{DD}	RF Output / Drain Voltage
8	N/C	No Connection
9	Pad ⁴	Ground

3. MACOM recommends connecting all No Connection (N/C) pins to ground.
4. The exposed pad centered on the package bottom must be connected to RF, DC and thermal ground.

Electrical Specifications: $V_{DD} = 5\text{ V}$, $+25^\circ\text{C}$, $Z_0 = 50\ \Omega$, Typical Application Circuit

Parameter	Test Conditions	Units	Min.	Typ.	Max.
Gain	0.05 - 3.25 GHz 4 GHz	dB	17 —	19 18	— —
Noise Figure	0.05 - 1.2 GHz 1.2 - 3.25 GHz 4 GHz	dB	—	1.3 1.6 2.1	— 2.2 —
Input Return Loss	0.05 - 3.25 GHz	dB	—	16	—
Output Return Loss	0.05 - 3.25 GHz	dB	—	14	—
Output IP3	$P_{IN} = -15\text{ dBm}$ per tone, 6 MHz spacing 0.05 - 1.2 GHz 1.2 - 3.25 GHz	dBm	—	36 33	—
Output IP2	$P_{IN} = -15\text{ dBm}$ per tone, 6 MHz spacing 0.05 - 1.2 GHz 1.2 - 3.25 GHz	dBm	—	45 36	—
Output P1dB	0.05 - 1.2 GHz 1.2 - 3.25 GHz	dBm	—	19.5 18.5	—
Current	I_{DD}	mA	—	80	115

Maximum Operating Conditions

Parameter	Absolute Maximum
RF Input Power CW	4 dBm
V_{DD}	7 V
Operating Temperature ⁵	-40°C to +85°C
Junction Temperature ⁶	+150°C

- Operating at nominal conditions with $T_J \leq 150^\circ\text{C}$ will ensure $\text{MTTF} > 1 \times 10^6$ hours.
- Junction Temperature (T_J) = $T_C + \Theta_{JC} * ((V * I) - (P_{OUT} - P_{IN}))$
Typical thermal resistance (Θ_{JC}) = 85°C/CW
 - For $T_C = +25^\circ\text{C}$,
 $T_J = 59^\circ\text{C}$ @ 5 V, 80 mA
 - For $T_C = +85^\circ\text{C}$,
 $T_J = 119^\circ\text{C}$ @ 5 V, 80 mA

Absolute Maximum Ratings^{7,8}

Parameter	Absolute Maximum
RF Input Power CW	30 dBm
V_{DD}	8 V
Storage Temperature	-55°C to +150°C
Junction Temperature ⁶	+175°C

- Exceeding any one or combination of these limits may cause permanent damage to this device.
- MACOM does not recommend sustained operation near these survivability limits.

Handling Procedures

Please observe the following precautions to avoid damage:

Static Sensitivity

Gallium Arsenide Integrated Circuits are sensitive to electrostatic discharge (ESD) and can be damaged by static electricity. Proper ESD control techniques should be used when handling these devices.

Typical Application Circuit

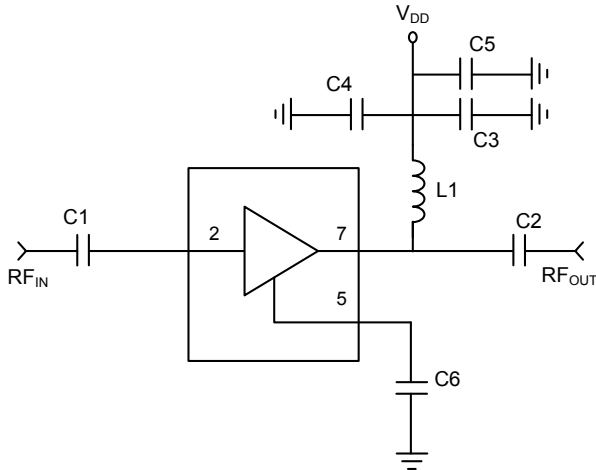

Typical Parts List, $V_{DD} = 5\text{ V} \& 3\text{ V}$

Component	Value	Package
C1 - C3, C6	1000 pF	0402
C4	0.1 μF	0402
C5	47 pF	0402
L1	Ferrite Bead ⁹	0402

9. Murata, part number BLM15HD182SN.

Current Adjust Options

The I_{ADJ} (pin 5) of MAAM-011229 may be used to adjust the DC operating current by placing either R1 or R2 as shown the schematic below. Placing resistor R2 to ground will reduce the current from typical application level. When using R2 to reduce current do not place (DNP) R1. To increase current from typical application circuit install resistor R1 and connect to V_{DD} .

The table below shows values of R1 and R2 for a range of operating currents for $V_{DD} = 5\text{ V}$ and 3 V .

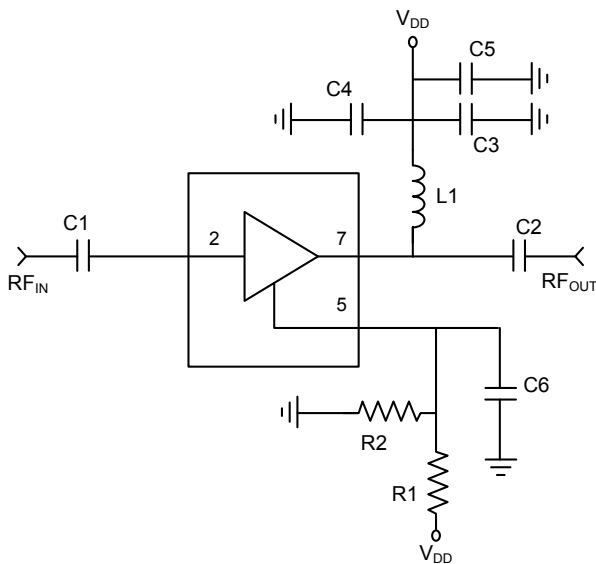

I (mA)	$V_{DD} = 5\text{ V}$		$V_{DD} = 3\text{ V}$	
	R1	R2	R1	R2
20	DNP	820 Ω	DNP	2.0 k Ω
40	DNP	1.2 k Ω	DNP	4.7 k Ω
60	DNP	2.7 k Ω	<i>Typical application without R1 and R2</i>	
80	<i>Typical application without R1 and R2</i>		5.0 k Ω	DNP
100	12 k Ω	DNP	2.4 k Ω	DNP
120	5 k Ω	DNP	not recommended	

Broadband Low Noise Amplifier 0.05 - 4 GHz

Rev. V2

Typical Performance Curves @ 5 V / 80 mA, $Z_0 = 50 \Omega$

Gain to 4 GHz

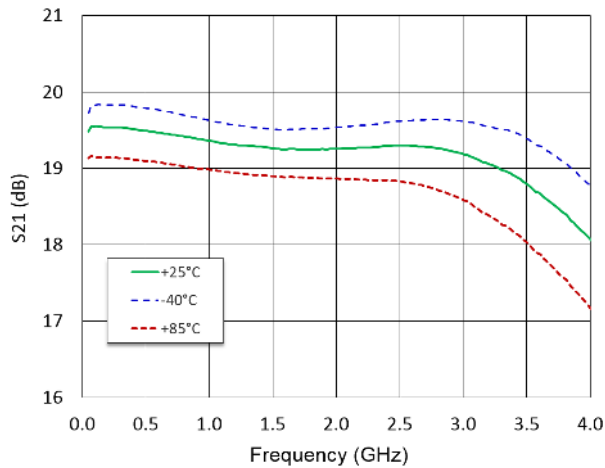

Gain to 8 GHz

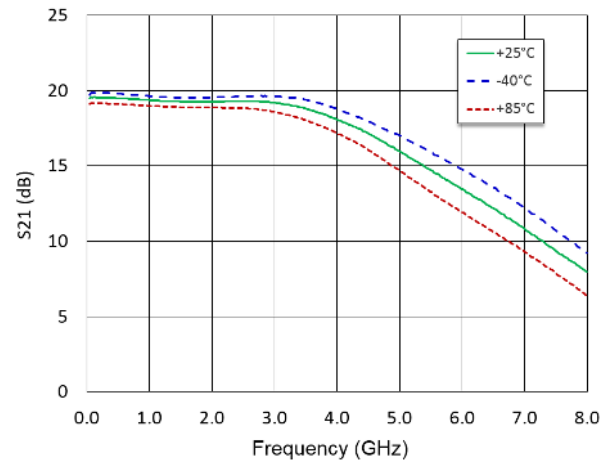

Input Return Loss

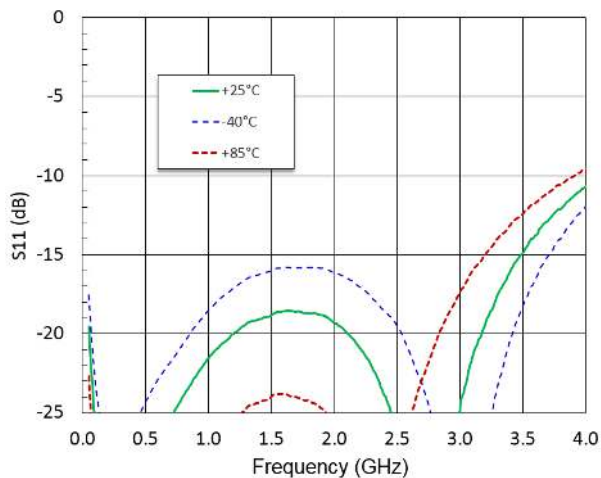

Output Return Loss

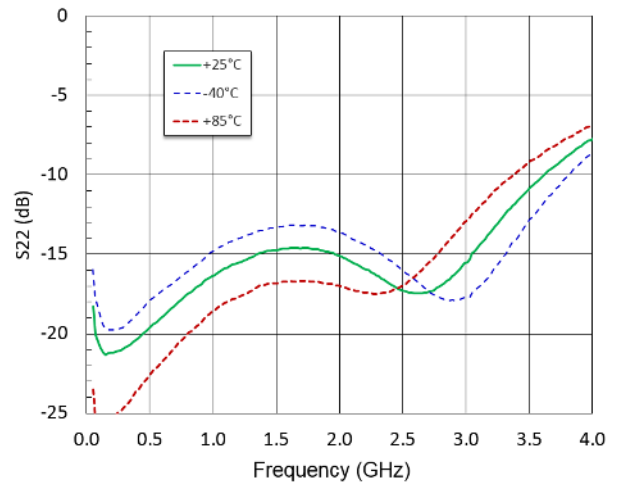

Noise Figure

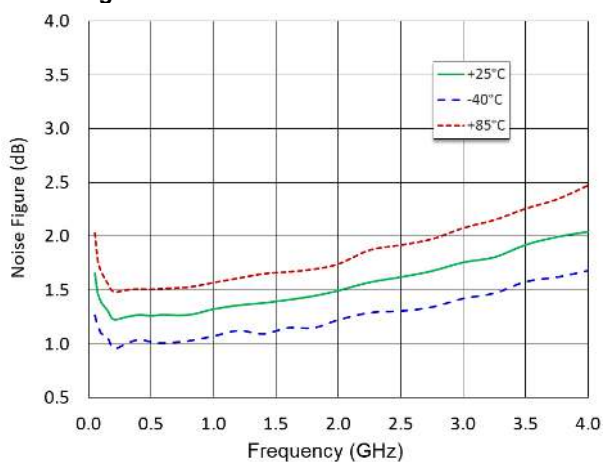

Reverse Isolation

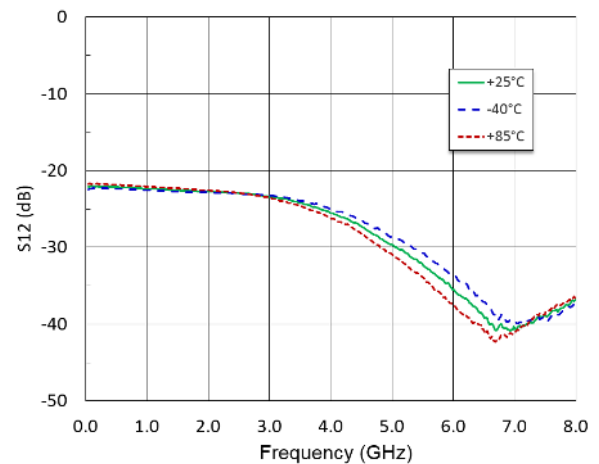

Broadband Low Noise Amplifier 0.05 - 4 GHz

Rev. V2

Typical Performance Curves @ 5 V / 80 mA , $Z_0 = 50 \Omega$

OIP3

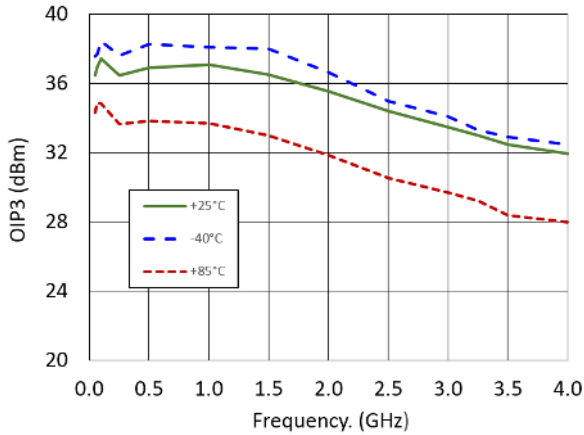

OIP2

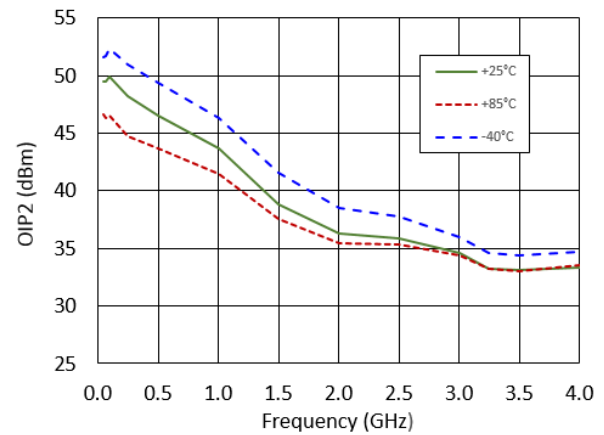

P1dB

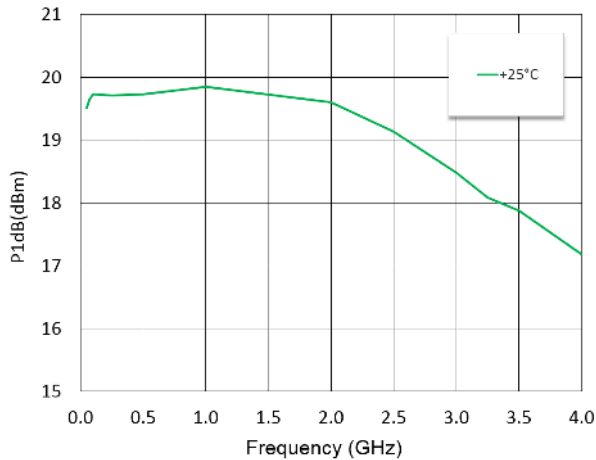

P1dB vs. Current, +25°C

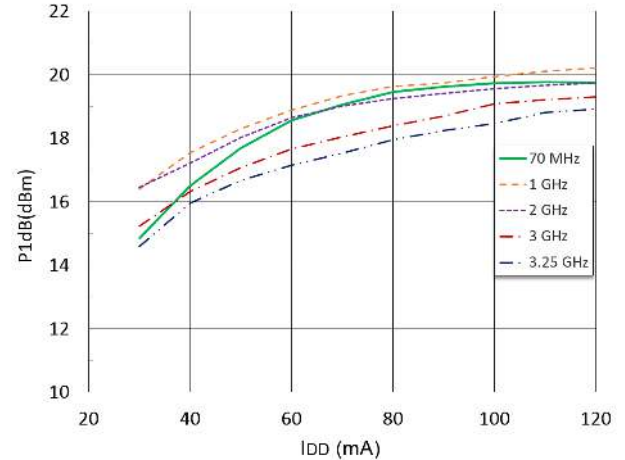

Noise Figure vs. Current, +25°C

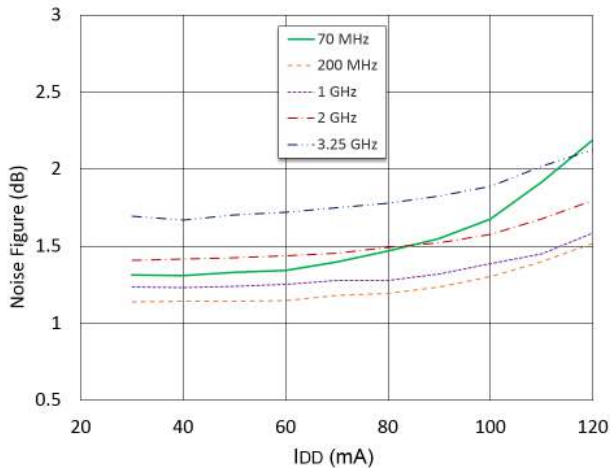

OIP3 vs. Current, +25°C

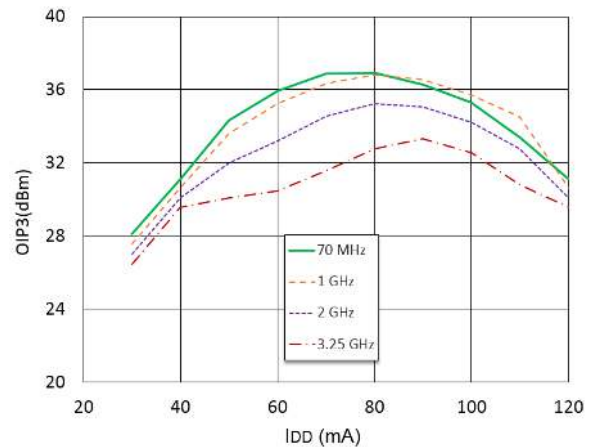

Electrical Specifications: $V_{DD} = 3\text{ V}$, $+25^{\circ}\text{C}$, $Z_0 = 50\ \Omega$, Typical Application Circuit

Parameter	Test Conditions	Units	Min.	Typ.	Max.
Gain	0.05 - 3.25 GHz 4 GHz	dB	—	19 18	—
Noise Figure	0.05 - 1.2 GHz 1.2 - 3.25 GHz 4 GHz	dB	—	1.3 1.6 2.1	—
Input Return Loss	0.05 - 3.25 GHz	dB	—	16	—
Output Return Loss	0.05 - 3.25 GHz	dB	—	14	—
Output IP3	$P_{IN} = -15\text{ dBm}$ per tone, 6 MHz spacing 0.05 - 1.2 GHz 1.2 - 3.25 GHz	dBm	—	33 40	—
Output IP2	$P_{IN} = -15\text{ dBm}$ per tone, 6 MHz spacing 0.05 - 1.2 GHz 1.2 - 3.25 GHz	dBm	—	43 37	—
Output P1dB	0.05 - 1.2 GHz 1.2 - 3.25 GHz	dBm	—	17.0 15.5	—
Current	I_{DD}	mA	—	60	—

Broadband Low Noise Amplifier 0.05 - 4 GHz

Rev. V2

Typical Performance Curves @ 3 V / 60 mA, $Z_0 = 50 \Omega$

Gain to 4 GHz

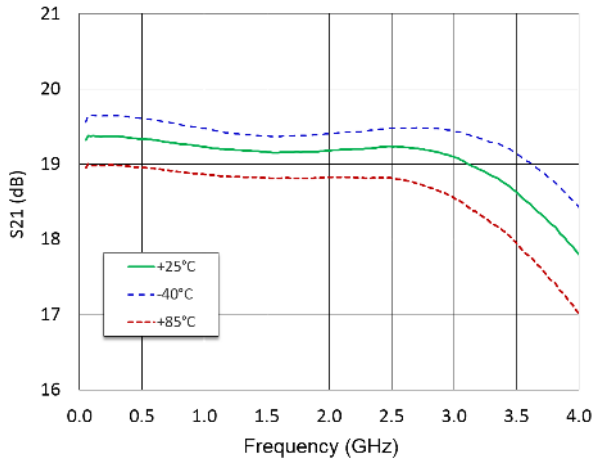

Gain to 8 GHz

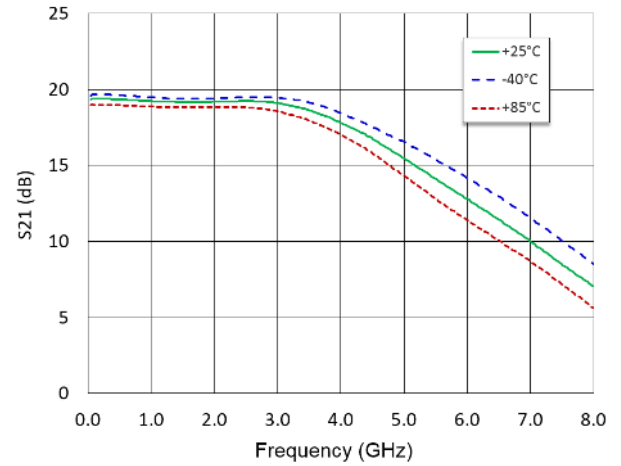

Input Return Loss

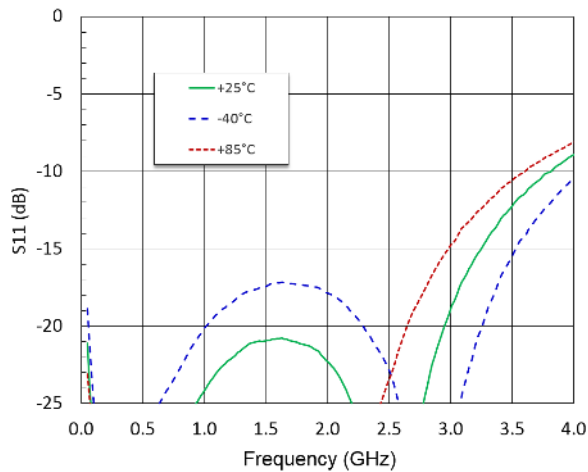

Output Return Loss

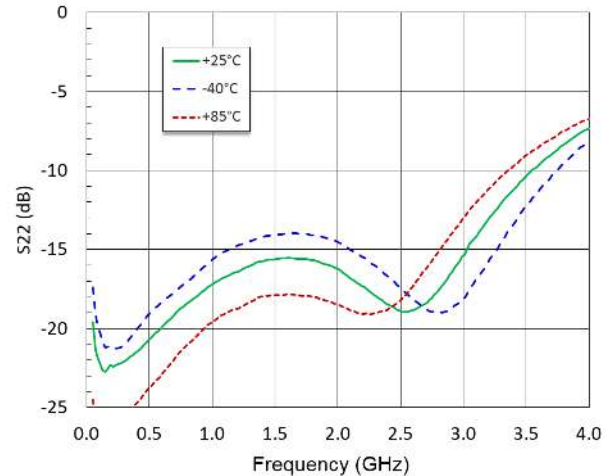

Noise Figure

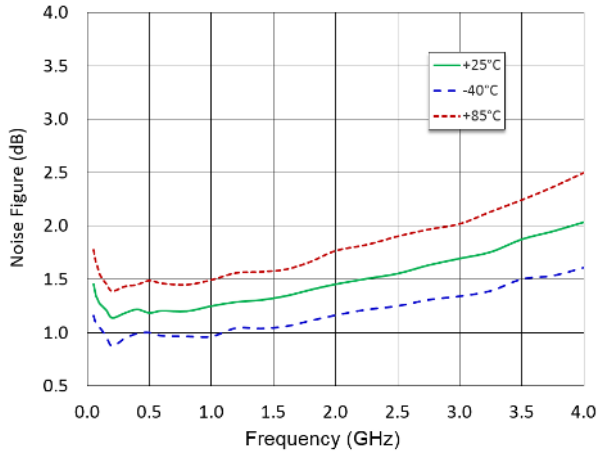

Reverse Isolation

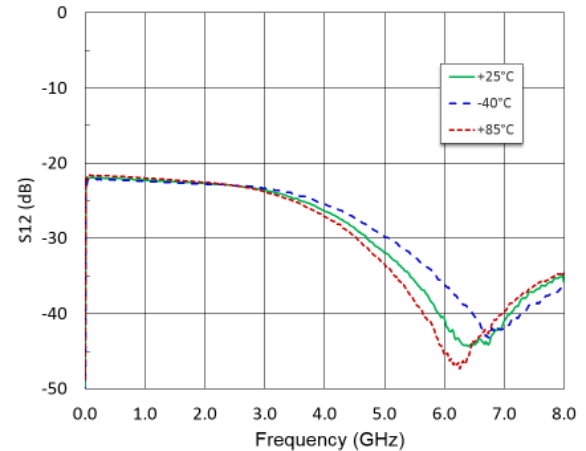

Broadband Low Noise Amplifier 0.05 - 4 GHz

Rev. V2

Typical Performance Curves @ 3 V / 60 mA, $Z_0 = 50 \Omega$

OIP3

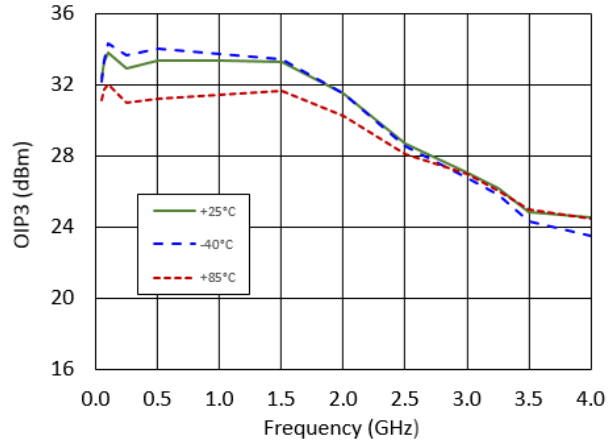

OIP2

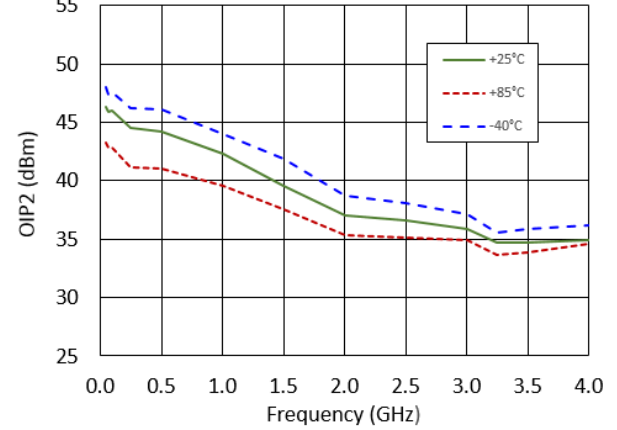

P1dB vs. Frequency

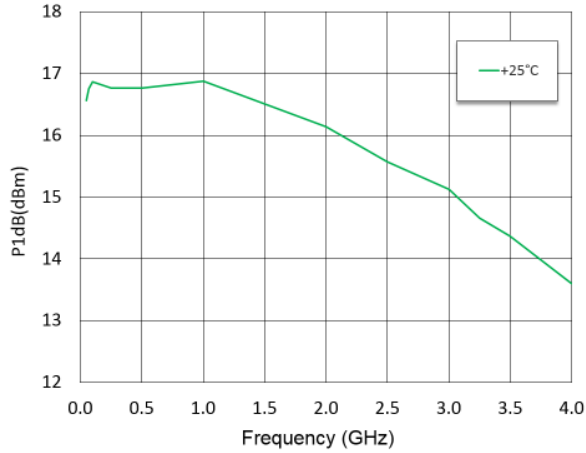

P1dB vs. Current, +25°C

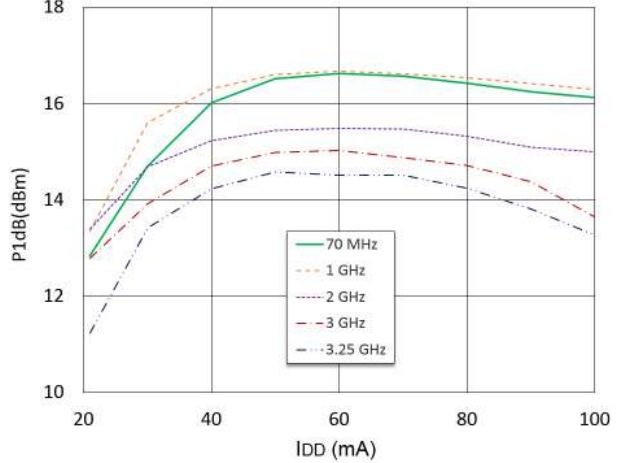

Noise Figure vs. Current, +25°C

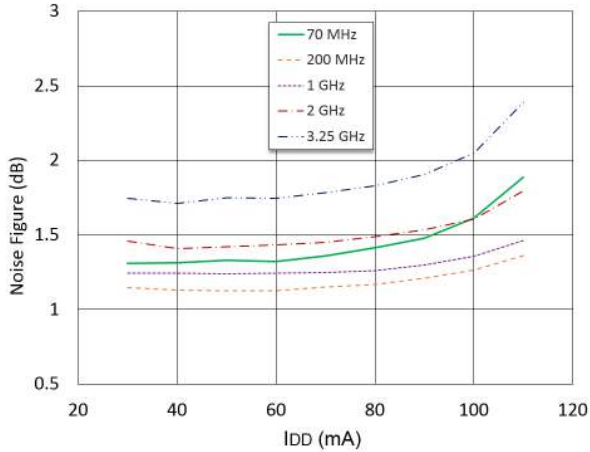

OIP3 vs Current, +25°C

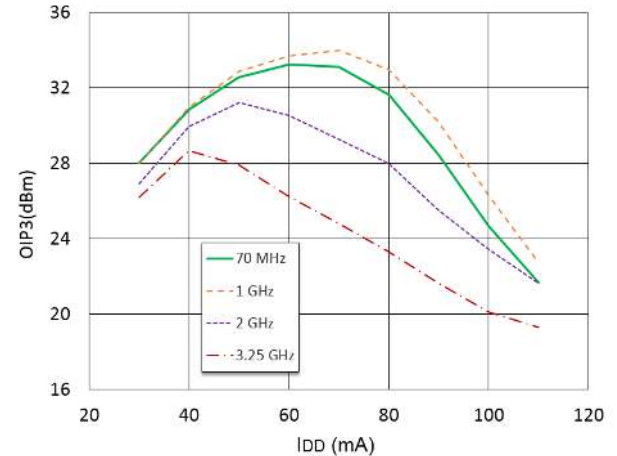

Recommended PCB Layout

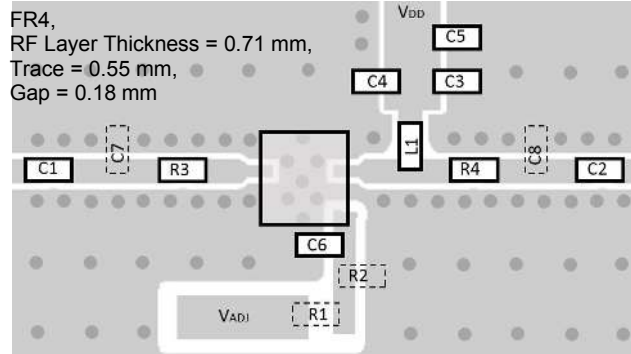

The recommended PCB layout includes place holders for additional components that are not necessary for typical applications but may be useful for extending performance to higher frequencies or optimizing a particular performance parameter at different bias conditions.

Sample Board Parts List

Component	Value	Package
C1 - C3, C6	1000 pF	0402
C4	0.1 μ F	0402
C5	47 pF	0402
C7, C8	DNP	0402
R3, R4	0 Ω	0402
R1, R2	DNP	0402
R3, R4	0 Ω	0402
L1	Ferrite Bead ¹⁰	0402

10. Murata, part number BLM15HD182SN.

Sample Board Schematic

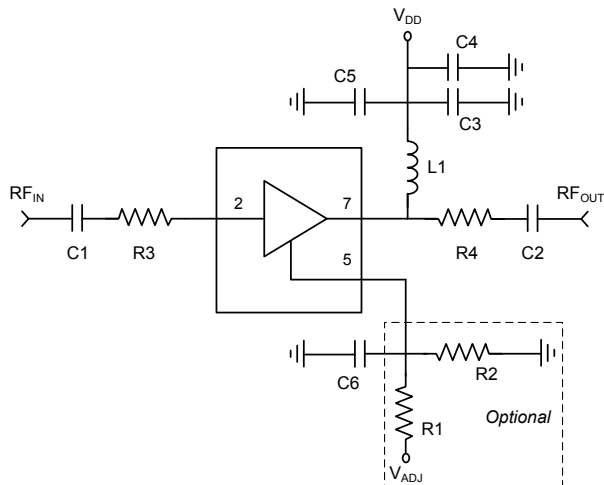

PCB Land Pattern

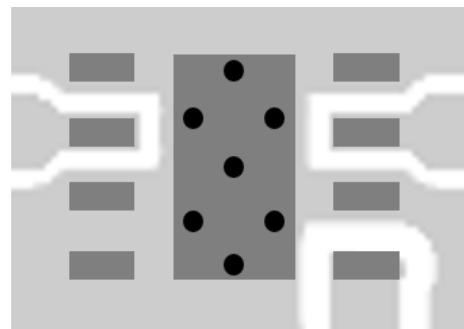

Applications Section: Power Down Option

The I_{ADJ} (pin 5) of MAAM-011229 may be used to power down and turn on the amplifier. The critical characteristics of the power down circuit are that it presents a low impedance to DC ground in the off mode and that it presents a high impedance (much greater than 5 k Ω) in the on mode. The single very low cost MMBT3904 NPN switching transistor (available from many suppliers) may be added externally along with a 1 k Ω resistor to provide this function. As shown in plots below, the time from when voltage on the I_{ADJ} pin (V_{ADJ}) goes HIGH to the time RF reaches 90% of final amplitude is 444 ns. The total turn-on time, however, from change of power down signal is 1.18 μ s (736 ns of this time is consumed in time for MMBT3904 to transition). Alternate choice for switching transistor could reduce total turn-on time. Total turn off time is 392 ns.

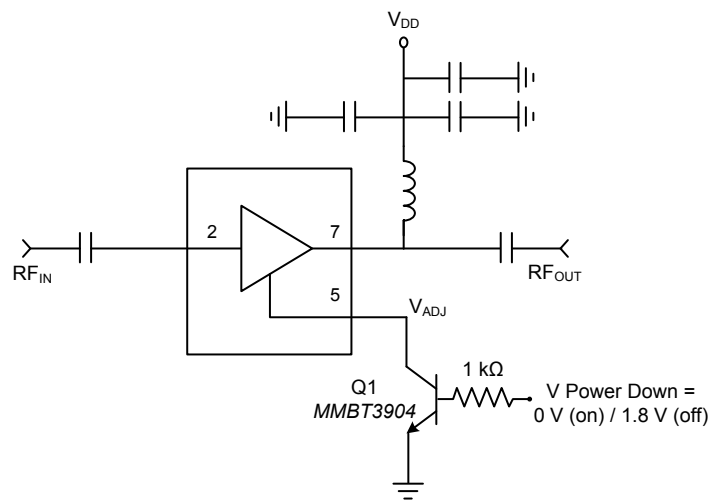

Turn ON Time

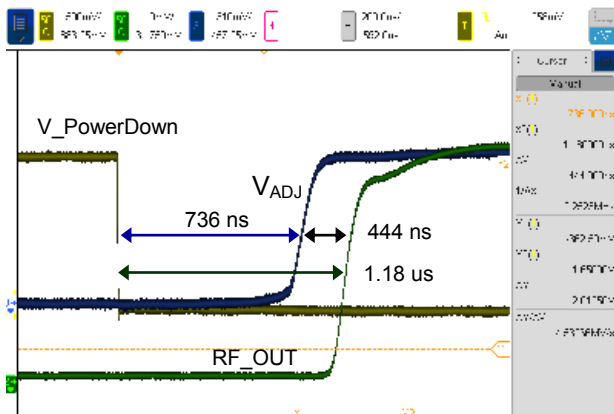

Turn OFF Time

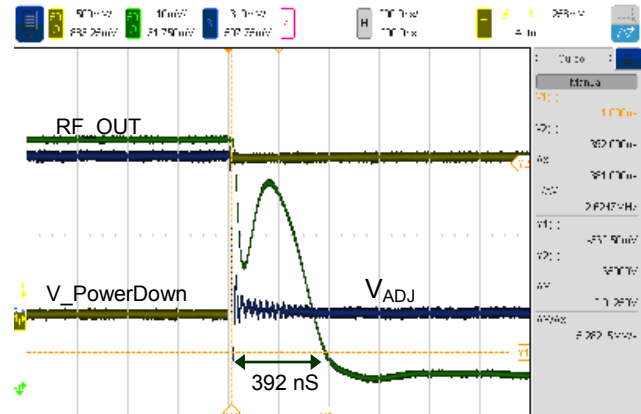

Lead-Free 2 mm 8-Lead PDFN[†]

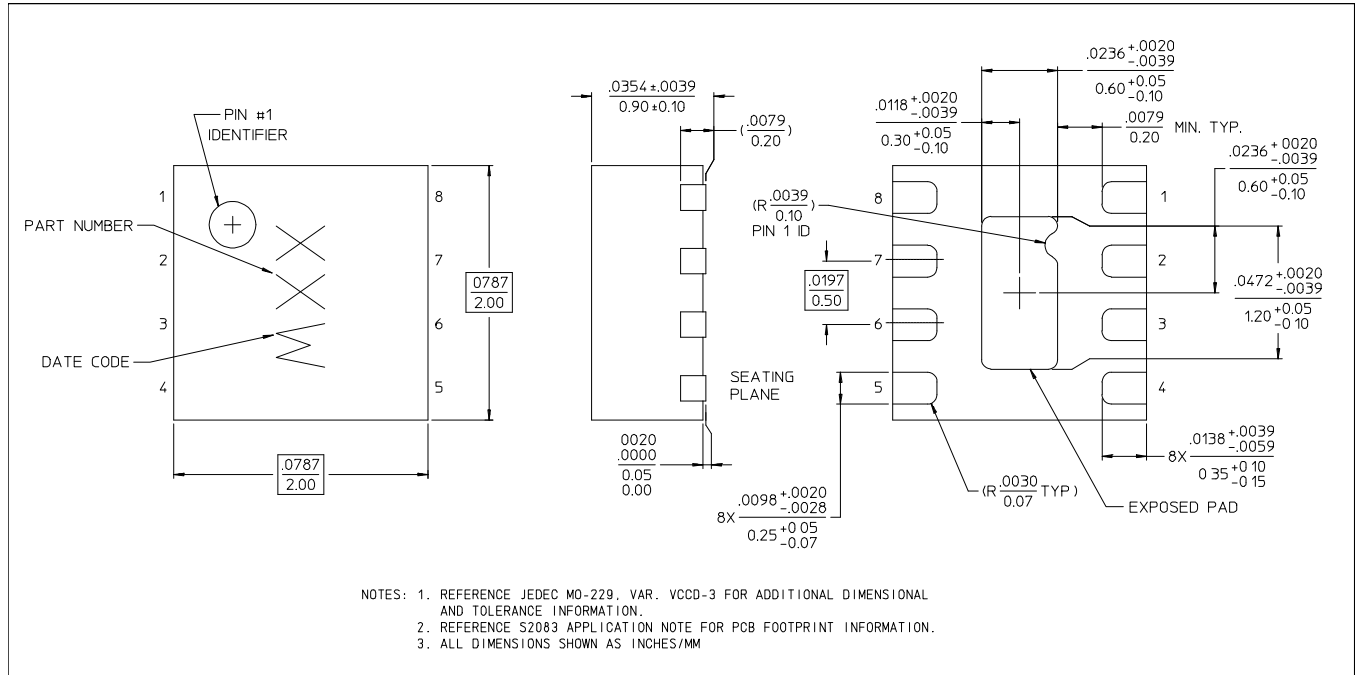

[†] Reference Application Note S2083 for lead-free solder reflow recommendations.
Meets JEDEC moisture sensitivity level 1 requirements.
Plating is 100% matte tin.

MACOM Technology Solutions Inc. All rights reserved.

Information in this document is provided in connection with MACOM Technology Solutions Inc ("MACOM") products. These materials are provided by MACOM as a service to its customers and may be used for informational purposes only. Except as provided in MACOM's Terms and Conditions of Sale for such products or in any separate agreement related to this document, MACOM assumes no liability whatsoever. MACOM assumes no responsibility for errors or omissions in these materials. MACOM may make changes to specifications and product descriptions at any time, without notice. MACOM makes no commitment to update the information and shall have no responsibility whatsoever for conflicts or incompatibilities arising from future changes to its specifications and product descriptions. No license, express or implied, by estoppel or otherwise, to any intellectual property rights is granted by this document.

THESE MATERIALS ARE PROVIDED "AS IS" WITHOUT WARRANTY OF ANY KIND, EITHER EXPRESS OR IMPLIED, RELATING TO SALE AND/OR USE OF MACOM PRODUCTS INCLUDING LIABILITY OR WARRANTIES RELATING TO FITNESS FOR A PARTICULAR PURPOSE, CONSEQUENTIAL OR INCIDENTAL DAMAGES, MERCHANTABILITY, OR INFRINGEMENT OF ANY PATENT, COPYRIGHT OR OTHER INTELLECTUAL PROPERTY RIGHT. MACOM FURTHER DOES NOT WARRANT THE ACCURACY OR COMPLETENESS OF THE INFORMATION, TEXT, GRAPHICS OR OTHER ITEMS CONTAINED WITHIN THESE MATERIALS. MACOM SHALL NOT BE LIABLE FOR ANY SPECIAL, INDIRECT, INCIDENTAL, OR CONSEQUENTIAL DAMAGES, INCLUDING WITHOUT LIMITATION, LOST REVENUES OR LOST PROFITS, WHICH MAY RESULT FROM THE USE OF THESE MATERIALS.

MACOM products are not intended for use in medical, lifesaving or life sustaining applications. MACOM customers using or selling MACOM products for use in such applications do so at their own risk and agree to fully indemnify MACOM for any damages resulting from such improper use or sale.