

PRODUCT NO  
10052607-001LF

FCI LOGO ENGRAVED

CONCAVE FEATURE

GATE (REFER NOTE 4)  
DRAFT ANGLE (REFER DETAIL D)

A

A

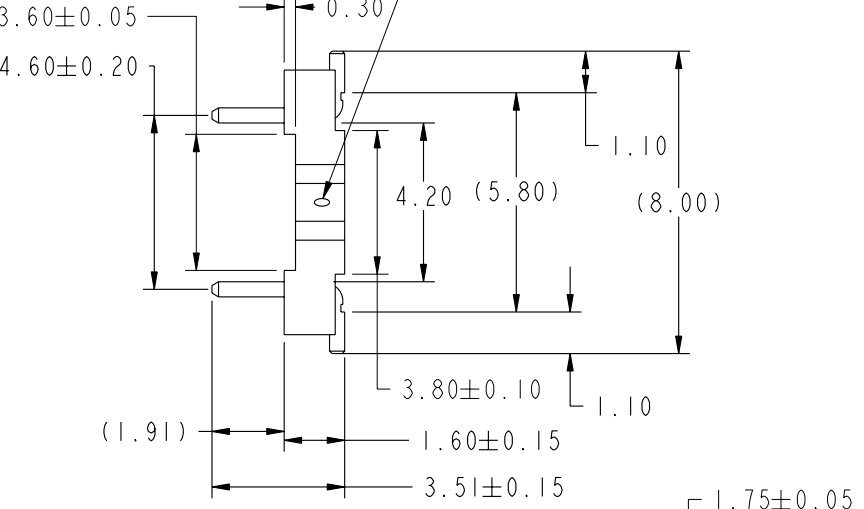
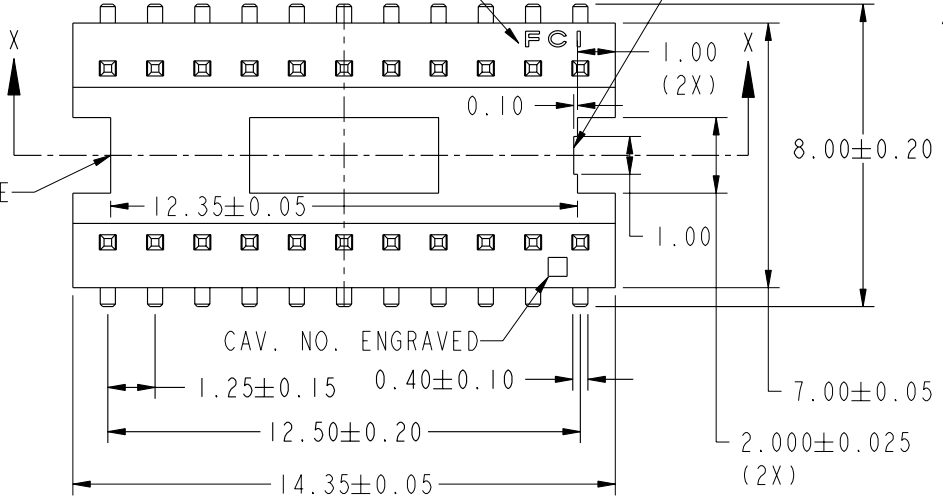

B

B

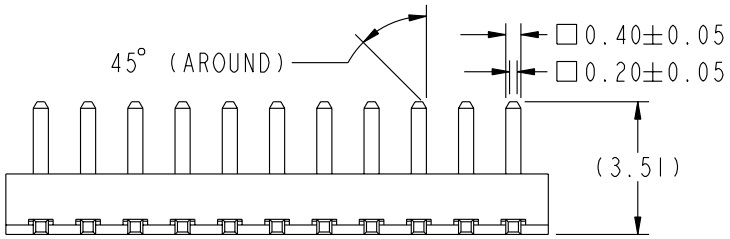

SCALE 5:1

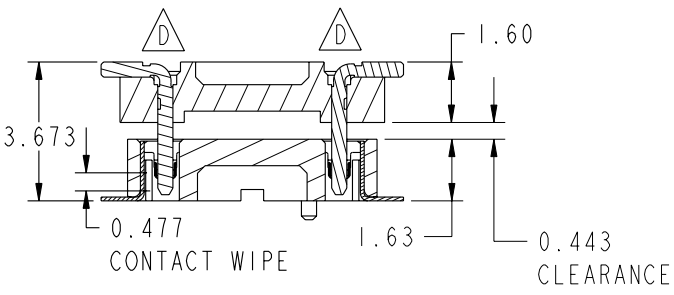
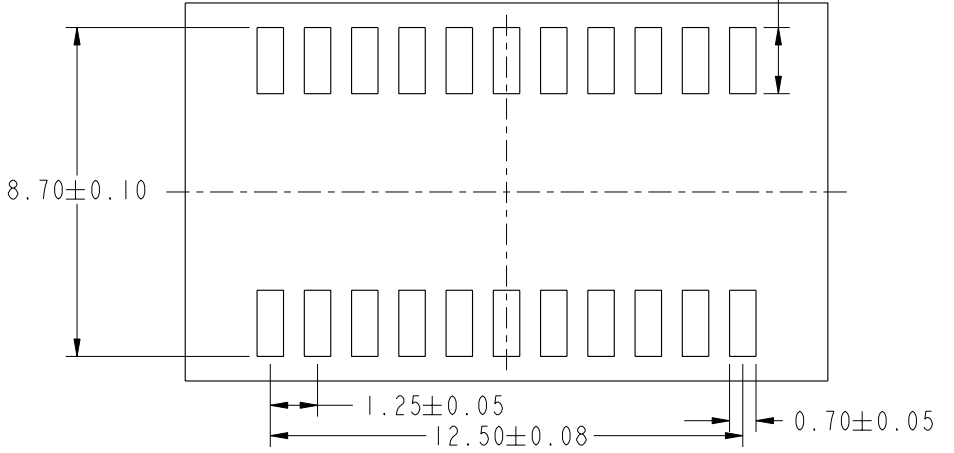

ORDINARY MATING STATE

Copyright FCI.

D

D

rev	ecn no	dr	date
A	S07-0151	KHL	2007-05-03
B	S08-0148	KHL	2008-05-16
C	S08-0410	DGOH	2008-12-18
D	S09-0244	DGOH	2009-08-04
-	-	-	-
-	-	-	-

www.fciconnect.com			surface	<input checked="" type="checkbox"/>	tolerance std	projection	MM			
			TOLERANCES UNLESS OTHERWISE SPECIFIED				←			
Dr	TAN SH	2005-01-07	ANGULAR	LINEAR	6 MAX	±0.2	size	A4	Scale	3:1
Eng	TAN SH	2005-01-20			6 to 30 MAX	±0.3	ECN			
Chr	DENNIS GOH	2008-08-04	0°	±2°	30 to 120 MAX	±0.5	Product family	Spec ref		
Appr	JOEY NG	2009-08-04								
			FCI			title		B+B 1.25P HEADER		
			catalog no			dwg no		10052607	Rev. D	
						CUSTOMER COPY		sheet 1 of 2		

A

B

A

B

SECTION X -X FOR TAPER JUDGEMENT STANDARD (REFER NOTE 5)

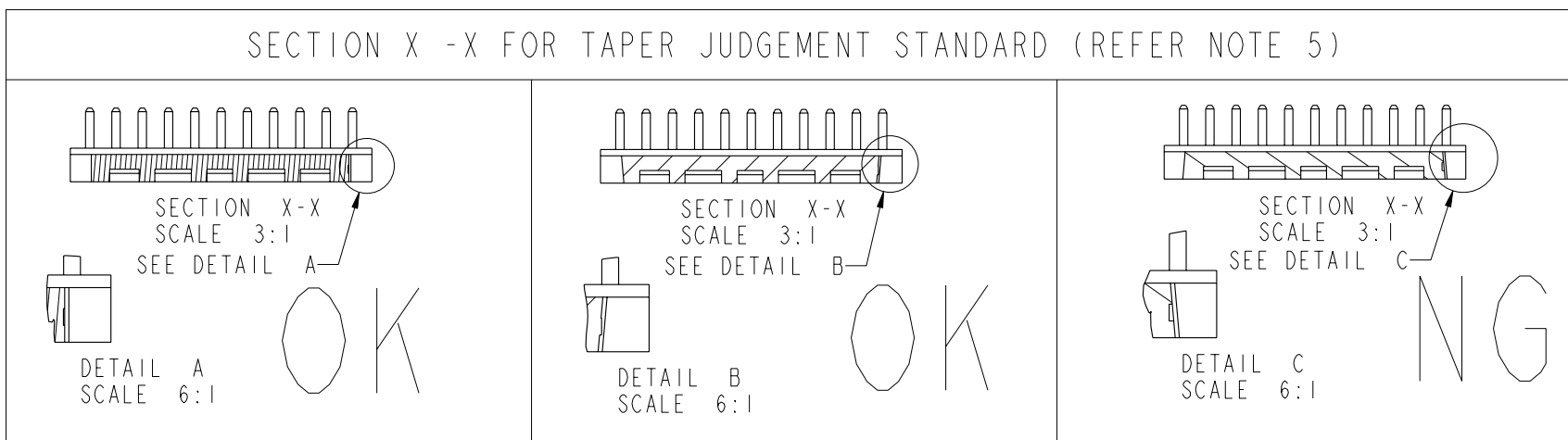

DETAIL D FOR HOUSING DRAFT ANGLE JUDGEMENT (REFER NOTE 5)

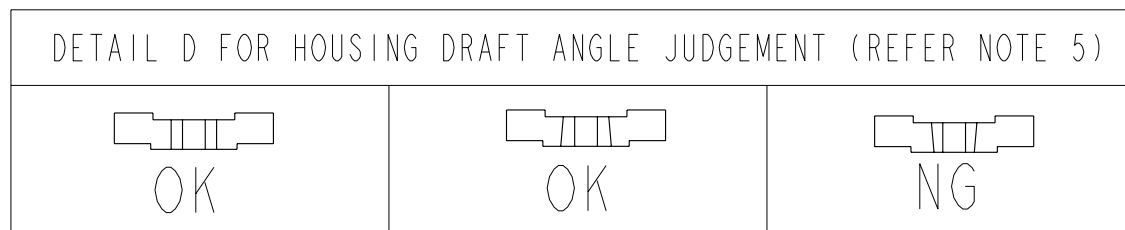

NOTES

1. MATERIAL:  
HOUSING: LCP, BLACK, UL94V-0  
CONTACT: PHOSPHOR BRONZE
2. FINISH:  
1.27-5.00 um NICKEL UNDERPLATE OVERALL  
0.10-0.30 um GOLD AT CONTACT AREA  
0.05-0.20 um GOLD AT SOLDER AREA
3. COPLANARITY OF TERMINAL: 0.1 mm MAX.
4. NO REMAINS OF GATING AND REMOVAL OF REMAINS ARE ALLOWED ON HOUSING SURFACES.
5. IF DRAFT ANGLE IS APPLIED (AS SHOWN IN SECTION X-X AND DETAIL D), ONLY THE INDICATED "OK" FEATURES ARE ALLOWED WITH DIMENSIONS WITHIN THE TOLERANCE RANGE.
6. PRODUCT SPECIFICATION: GS-12-391.
7. PACKAGING SPECIFICATION: GS-14-1088
8. THIS PRODUCT MEETS EUROPEAN UNION DIRECTIVES AND OTHER COUNTRY REGULATIONS AS DESCRIBED IN GS-22-008.
9. THE HOUSING WILL WITHSTAND EXPOSURE TO 260°C PEAK TEMPERATURE FOR 10 SECONDS IN A CONVECTION, INFRA-RED OR VAPOR PHASE REFLOW OVEN.
10. THIS PRODUCT COMPLIES WITH:  
NICA00001-0451 COMMON SPECIFICATION ON MATERIAL-CAUSED FAILURES  
NICA00001-5468  
AICA00051-0560 GENERAL SPECIFICATION ON SUBSTANCE CONTROL REQUIREMENTS  
LOCA52300-078X CONNECTOR PURCHASE SPECIFICATION
11. A  $\triangle$  SYMBOL WILL BE NEXT TO ANY DIMENSION, VIEW OR NOTE WHICH HAS BEEN MODIFIED WITH THE CURRENT DRAWING REVISION.

C

Copyright FCI.

D

C

D

	title	B+B 1.25P HEADER	dwg no	10052607	Rev.	D
	catalog no		CUSTOMER COPY	sheet 2 of 2		