

# DC FILTERING

## FFVE/FFVI (FFWE/FFWI RoHS Compliant)



**Not RoHS Compliant**



Please select correct termination style.

### GENERAL DESCRIPTION

The FFV capacitor is specifically designed for DC filtering, low reactive power.

The series uses a non-impregnated metallized polypropylene or polyester dielectric, which features a controlled self-healing process, specially treated to have a very high dielectric strength in operating conditions up to 105°C.

The FFV special design gives this series a very low level of stray inductance (18 nH to 40 nH).

Furthermore, the performance levels of the FFVE capacitor makes them a very interesting alternative to electrolytic technology, because they can withstand much higher levels of surge voltage, very high rms current ratings, and longer lifetimes.

### PACKAGING MATERIAL

Self-extinguishing plastic case (V0 = in accordance with UL 94) filled thermosetting resin.

Self-extinguishing thermosetting resin (V0 = in accordance with UL 94; I3F1 = in accordance with NF F 16-101).

FFVE capacitors meet the Level 2 requirement of the fire behavior standard NF F 16-102.

### DIMENSIONS

Also available with threaded female connections - M5 x 7.5mm max Torque 2.5Nm

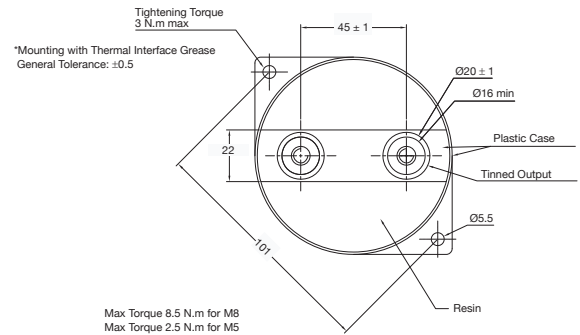
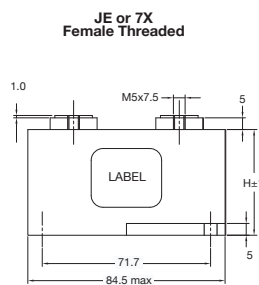
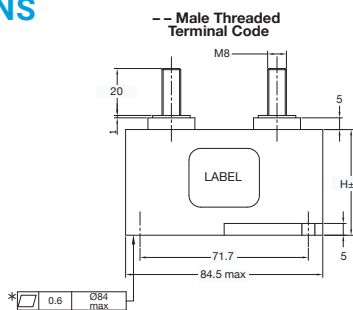

### HOW TO ORDER

**FFVE**

**Series**

FFVE = Standard  
FFVI = Standard  
FFWE = RoHS Compliant  
FFWI = RoHS Compliant

**6**

**Dielectric**

4 = Polyester  
6 = Polypropylene

**H**

**Voltage Code**

H = 300V L = 1000V  
I = 400V (FFVE/FFWE)  
J = 500V L = 1100V  
K = 600V (FFVI/FFWI)  
A = 700V U = 1200V  
B = 800V N = 1900V  
C = 900V

**0187**

**Capacitance Code**

0 = pF code  
0187 = 180µF  
0356 = 35µF etc.

**K**

**Capacitance Tolerances**  
K = ±10%

**--**

**Terminal Code**

-- or J7 = Male Threaded  
JE or 7X = Female Threaded  
See Ratings and Part Reference Tables for details

### HOT SPOT CALCULATION

See Hot Spot Temperature, page 3.

$$\theta_{hot\ spot} = \theta_{case} + (P_d + P_t) \times R_{th}$$

with  $P_d$  (Dielectric losses) =  $Q \times tg\delta_0$   
 $Q \times tg\delta_0 \Rightarrow [\frac{1}{2} \times C_n \times (V_{peak\ to\ peak})^2 \times f] \times tg\delta_0$   
 $tg\delta_0$  (tan delta)

For polypropylene,  $tg\delta_0 = 2 \times 10^{-4}$  for frequencies up to 1MHz and is independent of temperatures. For polyester,  $tg\delta_0$  values are shown in graph 4 on page 3.

$$P_t \text{ (Thermal losses)} = R_s \times (I_{rms})^2$$

where  $C_n$  in Farad  $I_{rms}$  in Ampere  $f$  in Hertz  
 $V$  in Volt  $R_s$  in Ohm  $\theta$  in °C  
 $R_{th}$  in °C/W

$\theta_{case}$  = bottom center of case

### Rs(f) vs FREQUENCY

For frequency higher than 1 kHz use following curve

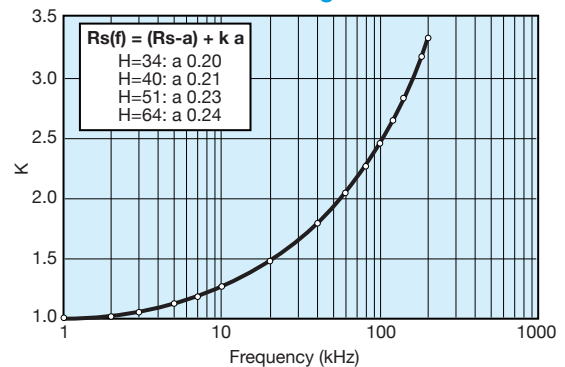

# DC FILTERING

## FFVE/FFVI (FFWE/FFWI RoHS Compliant)

### ELECTRICAL CHARACTERISTICS – FFVE/FFWE POLYESTER DIELECTRIC

Items	Characteristics
Working temperature	-40°C to +105°C (according to the power to be dissipated)
Capacitance range	100µF to 400µF
Capacitance tolerance	±10%
Rated DC voltage	300 to 400 V
Test voltage between terminals @ 25°C	1.5 x V <sub>n,dc</sub> 10s
Insulation voltage between shorted terminals and earth	7 kVrms/60sec/50Hz
Dielectric	Polyester

### RATINGS AND PART NUMBER REFERENCE – POLYESTER DIELECTRIC

Part Number*	Capacitance (µF)	Height (mm)	I <sub>rms</sub> max. (A)	L <sub>s</sub> max. (nH)	R <sub>s</sub> (mΩ)	R <sub>th</sub> (°C/W)	Typical Weight (g)
<b>V<sub>n,dc</sub> 300 volts (Voltage Code H)</b>							
FFVE4H0187K-	180	34	100	18	0.8	4.7	300
FFVE4H1956K-	195	34	100	18	0.8	4.4	300
FFVE4H0257K-	250	40	100	25	0.6	5.2	350
FFVE4H0357K-	350	51	100	32	0.8	7.2	420
FFVE4H0407K-	400	51	110	32	0.8	7.1	420
<b>V<sub>n,dc</sub> 400 volts (Voltage Code I)</b>							
FFVE4I0107K-	100	34	80	18	0.7	4.7	300
FFVE4I0127K-	120	34	100	18	0.6	4.1	300
FFVE4I0157K-	150	40	100	25	0.7	5.0	350
FFVE4I0187K-	180	51	80	32	1.0	8.5	420
FFVE4I0227K-	220	51	100	32	0.9	7.2	420

\*Change "--" to "JE" for female connectors M5 x 7.5mm

Dimensions millimeters

### LIFETIME EXPECTANCY FFVE POLYESTER

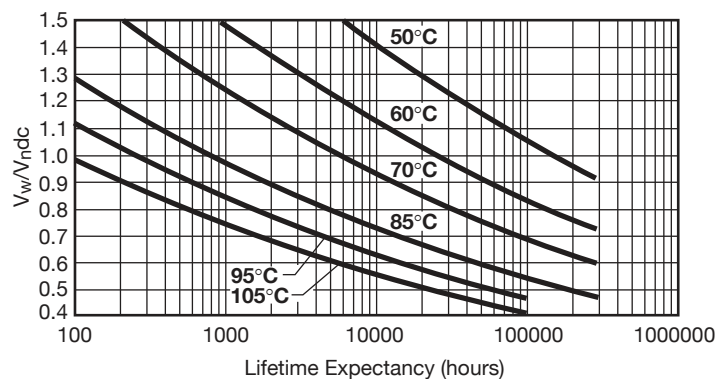

V<sub>w</sub> = Permanent working or operating DC voltage.

# DC FILTERING

## FFVE/FFVI (FFWE/FFWI RoHS Compliant)

### ELECTRICAL CHARACTERISTICS – FFVE/FFWE POLYPROPYLENE DIELECTRIC

Items	Characteristics
Working temperature	-40°C to +105°C (according to the power to be dissipated)
Capacitance range	12μF to 220μF
Capacitance tolerance	±10%
Rated DC voltage	600 to 1900 V
Test voltage between terminals @ 25°C	1.5 x V <sub>n,dc</sub> 10s
Insulation voltage between shorted terminals and earth	7 kVrms/60sec/50Hz
Dielectric	Polypropylene

### RATINGS AND PART NUMBER REFERENCE – POLYPROPYLENE DIELECTRIC

Part Number*	Capacitance (μF)	Height (mm)	I <sub>rms</sub> max. (A)	L <sub>s</sub> max. (nH)	R <sub>s</sub> (mΩ)	R <sub>th</sub> (°C/W)	Typical Weight (g)
<b>V<sub>n,dc</sub> 600 volts (Voltage Code K)</b>							
FFVE6K0256K--	25	34	90	18	0.7	4.3	300
FFVE6K0107K--	100	40	100	25	0.6	4.8	350
FFVE6K0157K--	150	51	110	32	0.9	6.9	420
FFVE6K0227K--	220	64	100	40	1.0	8.4	500
<b>V<sub>n,dc</sub> 800 volts (Voltage Code B)</b>							
FFVE6B0666K--	66	40	100	25	0.7	4.7	350
FFVE6B0107K--	100	51	90	32	1.0	6.7	420
FFVE6B0147K--	140	64	100	40	1.3	8.4	500
<b>V<sub>n,dc</sub> 900 volts (Voltage Code C)</b>							
FFVE6C0126K--	12	34	70	18	0.9	4.4	300
FFVE6C0386K--	38	34	100	18	1.6	3.9	300
FFVE6C0476K--	47	40	100	25	0.8	4.6	350
FFVE6C0706K--	70	51	100	32	1.2	6.7	420
FFVE6C0107K--	100	64	90	40	1.1	8.2	500
<b>V<sub>n,dc</sub> 1000 volts (Voltage Code L)</b>							
FFVE6L0666KJ7	66	40	70	25	1.5	5.1	350
FFVE6L0107KJ7	100	51	64	32	2.0	7.3	420
FFVE6L0147KJ7	140	64	51	40	2.5	9.2	500
<b>V<sub>n,dc</sub> 1200 volts (Voltage Code U)</b>							
FFVE6U0476KJ7	47	40	66	25	1.7	4.9	350
FFVE6U0706KJ7	70	51	59	32	2.4	7.2	420
FFVE6U0107KJ7	100	64	49	40	2.9	8.9	500
<b>V<sub>n,dc</sub> 1900 volts (Voltage Code N)</b>							
FFVE6N0156KJ7	15	40	73	25	1.1	5.2	350
FFVE6N0246KJ7	24	51	73	32	1.3	6.5	420
FFVE6N0356KJ7	35	64	67	40	1.6	8.4	500

\*Change "--" to "JE" for female connectors M5 x 7.5mm

Dimensions millimeters

\*Change "J7" to "7X" for female connectors M5 x 7.5mm

### LIFETIME EXPECTANCY FOR FFVE POLYPROPYLENE

-- and JE

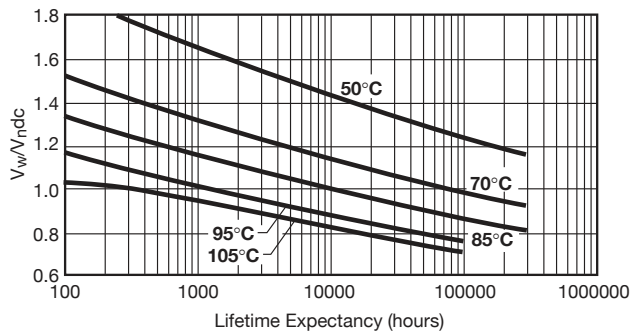

V<sub>w</sub>: permanent working or operating DC-voltage.

J7 and 7X

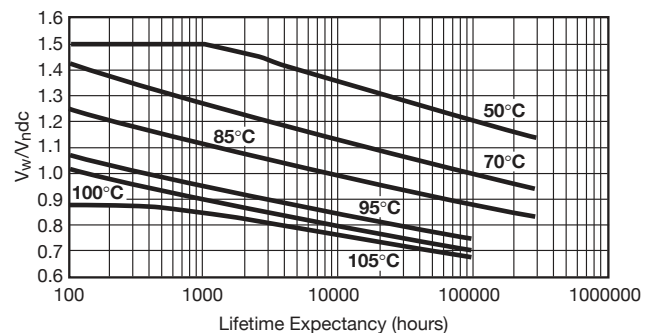

V<sub>w</sub>: permanent working or operating DC-voltage.

# DC FILTERING

FFVE/FFVI (FFWE/FFWI RoHS Compliant)



## ELECTRICAL CHARACTERISTICS – FFVE/FFWE POLYPROPYLENE DIELECTRIC

Items	Characteristics
Working temperature	-40°C to +105°C (according to the power to be dissipated)
Capacitance range	47µF to 275µF
Capacitance tolerance	±10%
Rated DC voltage	500 to 1100V
Test voltage between terminals @ 25°C	1.25 x $V_{n,dc}$ 10s
Insulation voltage between shorted terminals and earth	7 kVrms/60sec/50Hz
Dielectric	Polypropylene

## RATINGS AND PART NUMBER REFERENCE – POLYPROPYLENE DIELECTRIC

Part Number*	Capacitance (µF)	Height (mm)	Irms max. (A)	Ls max. (nH)	Rs (mΩ)	Rth (°C/W)	Typical Weight (g)
<b><math>V_{n,dc}</math> 500 volts (Voltage Code J)</b>							
FFVI6J1256K-	125	40	90	25	0.6	5.0	350
FFVI6J0207K-	200	51	90	32	0.8	6.7	420
FFVI6J2756K-	275	64	90	40	0.9	8.7	500
<b><math>V_{n,dc}</math> 700 volts (Voltage Code A)</b>							
FFVI6A0107K-	100	40	100	25	0.6	4.8	350
FFVI6A0157K-	150	51	100	32	0.9	6.9	420
FFVI6A0227K-	220	64	100	40	1.0	8.4	500
<b><math>V_{n,dc}</math> 900 volts (Voltage Code C)</b>							
FFVI6C0666K-	66	40	100	25	0.7	4.7	350
FFVI6C0107K-	100	51	90	32	1.0	6.7	420
FFVI6C0147K-	140	64	100	40	1.3	8.4	500
<b><math>V_{n,dc}</math> 1100 volts (Voltage Code L)</b>							
FFVI6L0476K-	47	40	100	25	0.8	4.6	350
FFVI6L0706K-	70	51	100	32	1.2	6.7	420
FFVI6L0107K-	100	64	90	40	1.1	8.2	500

Dimensions millimeters

## LIFETIME EXPECTANCY FOR FFVI

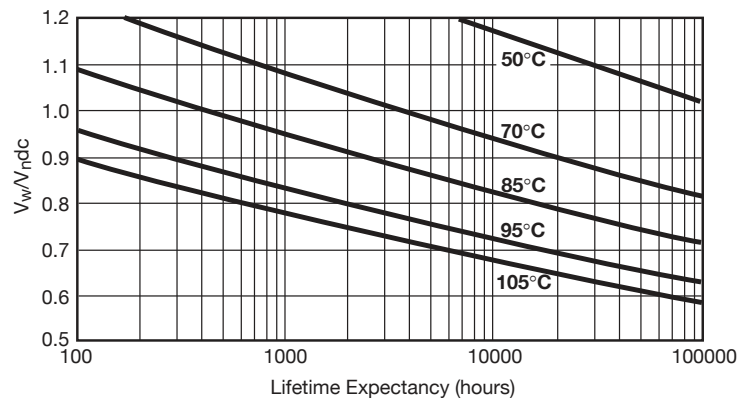

$V_w$ : permanent working or operating DC-voltage.