

Three phase power solid state relay Relais statique triphasé de puissance

SGT8698504

- Zero Cross Solid State Relay specially designed for most types of loads.
- Over-Voltage protection on input (transil) and output (RC+VDR).
- Back to back thyristors on output with TMS² technology for a long lifetime expectancy, RoHS void free process.
- Direct copper bonding (DCB) technology.
- Large control range: 24-255VAC/DC. Green LED visualization on the input.
- Designed in conformity with IEC/ EN60947-4-3 and IEC/ EN60947-4-2.
- Built in IP20 - protection with flaps.
- Relais statique synchrone spécialement adapté à la plupart des charges.
- Protection en tension sur l'entrée (transil) et sur la sortie (VDR+RC).
- Sorties thyristors technologie TMS² permettant une longue durée de vie, procédé soudure RoHS sans voids.
- Technologie DCB (Direct Copper Bonding).
- Large plage de contrôle: 24-255VAC/DC avec un courant de commande régulé. LED de visualisation sur l'entrée de couleur verte.
- Construit en conformité à la norme IEC/EN60947-4-3 et IEC/EN60947-4-2.
- Protection contre le toucher IP20 avec volets de protection.

Output / Sortie : 24-520VAC (±10%)
Input / Entrée : 24-255VAC/DC

125A / 1600Vpeak Thyristors.
I²t = 22000A²s.
64A AC51 (Resistive / Résistif).
32A AC53 (Motor / Moteur).



Typical application / Application typique:

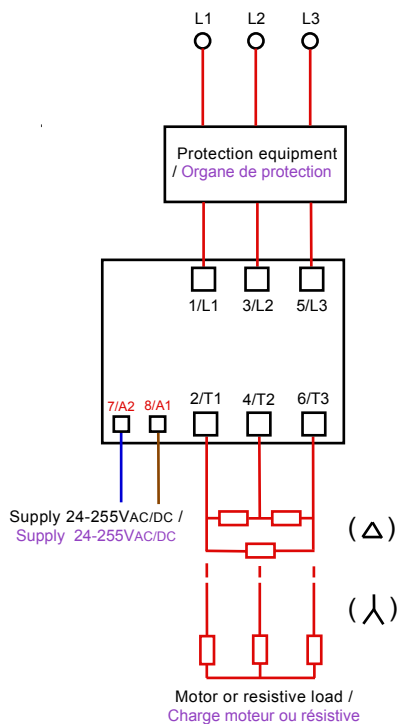

Synoptic / Synoptique:

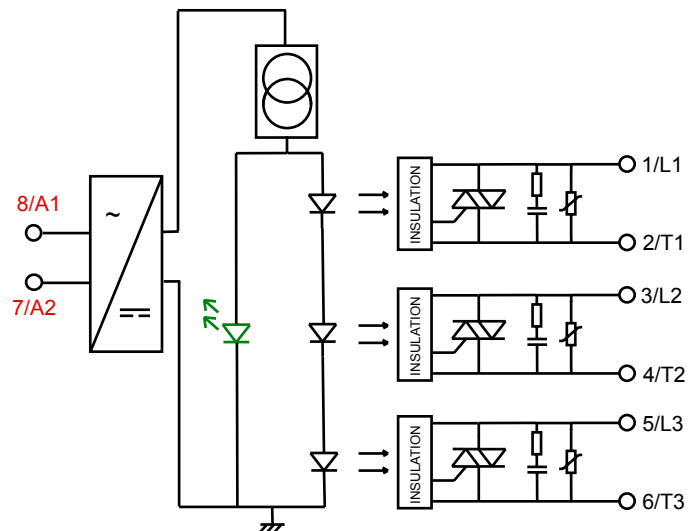

Proud to serve you

celduc[®]
r e l a i s

Control characteristics (at 25°C) / Caractéristiques de commande (à 25°C)

Parameter / Paramètre	Symbol	DC			Unit
		Min	Nom	Max	
Control voltage / Tension de commande	Uc	24		255	V
Control current (@Uc) / Courant de commande	Ic		<7		mA
Release voltage / Tension de relachement	Uc off	2			V
Input internal resistor / Résistance interne	Rc	current regulator			Ω

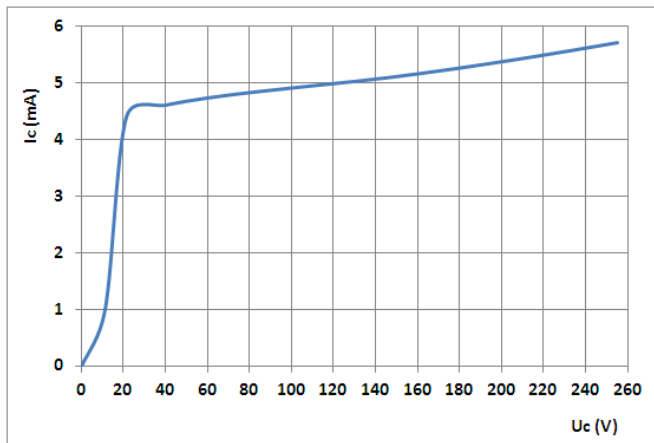

$$I_c = f(U_c) / I_c = f(U_c)$$

Output characteristics (at 25°C) / Caractéristiques de sortie (25°C)

Parameter per leg / Paramètre par voie	Conditions	Symbol	Min	Typ.	Max	Unit
Operating voltage range / Plage de tension d'utilisation		Ue	24	400	520	V rms
Peak voltage / Tension crête		Up		1600		V
Zero cross level / Niveau de synchronisme		U _{sync}	10			V
Latching voltage / Tension minimum amorçage	le nom	Ua			10	V
Nominal current / Courant nominal @40°C (AC-51) ⁽¹⁾		Ie AC-51		64		A rms
Nominal current / Courant nominal @40°C (AC-53) ⁽¹⁾		Ie AC-53		32		A rms
Non repetitive overload current / Courant de surcharge	tp=20ms	I _{tsm}	2000	2100		A
On state voltage drop / Chute directe à l'état passant	@ 25°C	Vt			1	V
On state dynamic resistance / Résistance dynamique		rt			2	mΩ
Output power dissipation (max value) / Puissance dissipée (max)		Pd	0.9x1xIe + 0,002 x Ie ²			W
Thermal resistance between junction to case (one leg) / Résistance thermique jonction/semelle (1 voie)		R _{thj/c}		0,25		K/W
Off state leakage current / Courant de fuite à l'état bloqué	@Ue typ, 50Hz	I _{lk}			1	mA
Minimum load current / Courant minimum de charge		I _{emin}	5			mA
Turn on time / Temps de fermeture (cycles)		ton max		0,5		
Turn off time / Temps d'ouverture (cycles)		toff max		0,5		
Operating frequency range / Fréquence utilisation	F mains	f	0,1	50-60	400	Hz
Off state dv/dt / dv/dt à l'état bloqué		dv/dt	500			V/μs
Maximum di/dt non repetitive / di/dt max non répétitif		di/dt			50	A/μs
I ² t (<10ms)		I ² t	20000	22000		A ² s
Conducted immunity level / Immunité conduite	IEC/EN61000-4-4 (bursts)		4kV criterion A			
Conducted immunity level / Immunité conduite	IEC/EN61000-4-5 (surge)		4kV criterion A			
Short circuit protection / Protection court-circuit (@100kA)	type 2 coordination	Example	Fuse MERSEN type gRC			

⁽¹⁾ : with heatsink see fig 1. / Avec dissipateur voir fig1.



General characteristics (at 25°C) / Caractéristiques générales	Symbol	Min	Typ.	Max
Input to output insulation / Isolement entrée/sortie	Ui		4000	VRMS
Output to case insulation / Isolation sortie/semelle	Ui		4000	VRMS
Insulation resistance / Résistance d'isolement	Ri		1000 (@500VDC)	MΩ
Rated impulse voltage / Tenue aux tensions de chocs	Uimp		4000	V
Protection level / Degré de protection / CEI529			IP20	
Pollution degree / Degré de pollution	-		2	
Vibration withstand / Vibrations IEC60068-2-6 ⁽²⁾			1,5	mm
Shocks withstand / Tenue aux chocs IEC60068-2-6	-		30/50	g
Ambient operating temperature / Température de fonctionnement	-		-40 / +85	°C
Storage temperature / Température de stockage ⁽³⁾			-40/+125	°C
Relative humidity / Humidité relative	HR		40 to 85	%
Weight / Poids			1570	g
Conformity / Conformité			EN60947-4-3 (IEC947-4-3)	
			EN60947-4-2 (IEC947-4-2)	
			EN 62314	
Conformity (VDE laboratory) / Construit en conformité	EN		EN60950 / EN60335-1	
Conformity / Conformité	UL/CSA		Pending / en cours	
Housing Material / Matière du boîtier			PA 6 UL94VO	
Housing Material / Matière du boîtier			EN 60695-2 (VDE approval)	
Base plate / Semelle			Tin plate Aluminum / Aluminium	

⁽²⁾ : 10-150Hz, double amplitude / 10-150Hz double amplitude

⁽³⁾ : no icing, no condensation / pas de glace, pas de condensation

Thermal curves and heatsink choice / Courbes thermiques & Choix dissipateur thermique (fig 1.)

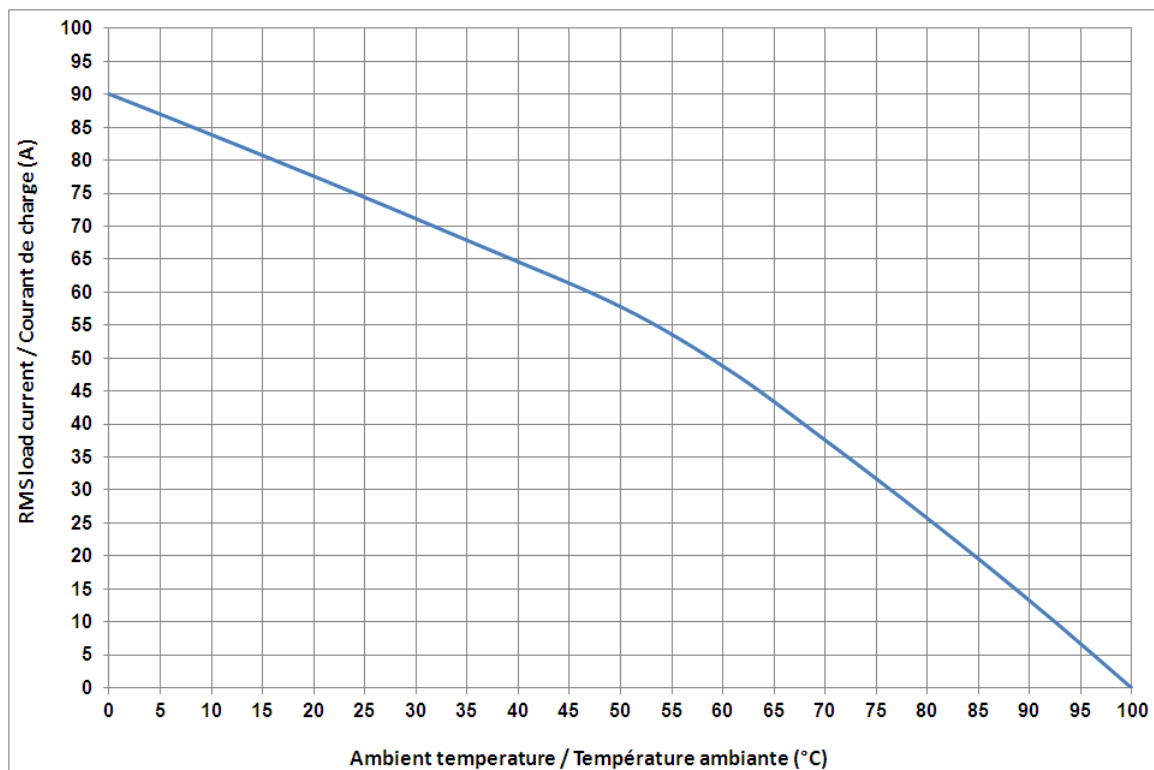

celduc
r e l a i s

www.celduc.com

5, Rue Ampère BP30004 42290 SORBIERS - FRANCE E-mail : celduc-relais@celduc.com
 Fax +33 (0) 4 77 53 85 51 Service Commercial France Tél. : +33 (0) 4 77 53 90 20
 Sales Dept.For Europe Tel. : +33 (0) 4 77 53 90 21 Sales Dept. Asia : Tél. +33 (0) 4 77 53 90 19

Overload currents one leg / Courants de surcharges par voie:

1 - No repetitive I_{tsm} is given without voltage reapplied .
This curve is used to define the protection (fuses).

1 - I_{tsm} non répétitif (1) sans tension réappliquée est donné pour la détermination des protections.

2 - Repetitive I_{tsm} is given for inrush current with initial $T_j = 70^\circ\text{C}$. In normal operation, this curve musn't be exceeded.
Caution, frequent over load currents will decrease the life expectancy of the SSR.

2 - I_{tsm} répétitif (2) est donné pour des surcharges de courant (T_j initiale= 70°C).

Attention : la répétition de ces surcharges de courant diminue la durée de vie du relais.

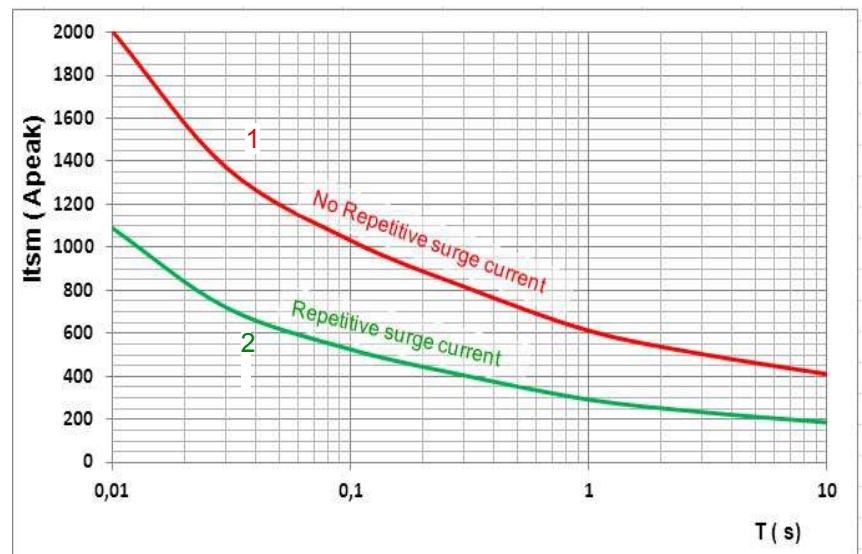

→ Warning ! semiconductor relays don't provide any galvanic insulation between the load and the mains. Always use in conjunction with an adapted circuit breaker with insulation feature or a similar device in order to ensure a reliable insulation in the event of wrong function and when the relay must be insulated from the mains (maintenance ; if not used for a long duration ...).

It is important that the solid state relay is subject to correct installation, maintenance and use conforming to its intended regulations and standards, to the supplier's instructions and to accepted rules of art.

→ Attention ! les relais à semi-conducteurs ne procurent pas d'isolation galvanique entre le réseau et la charge. Ils doivent être utilisés associés à un disjoncteur avec propriété de sectionnement ou similaire, afin d'assurer un sectionnement fiable en amont de la ligne dans l'hypothèse d'une défaillance et pour tous les cas où le relais doit être isolé du réseau (maintenance; non utilisation sur une longue durée...).



Sous réserve d'installation, d'entretien et d'utilisation conformes à sa destination, à la réglementation, aux normes en vigueur, aux instructions du constructeur et aux règles de l'art.



Connections / Raccordement:

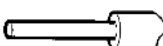
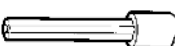
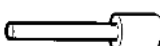

Direct connection with wires with or without ferrules /
Directement avec fils avec ou sans embouts

With ring terminals /
Avec cosses

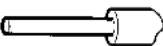
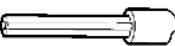
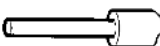

cel3pac [®] Control wiring / Raccordement d'entrée				Screwdriver type / Modèle de tournevis	Couple de serrage recommandé Vis M4
Number of wires / Nombre de fils					
1		2		 Recommended tightening torque M4 screw N.m	
SOLID (No ferrule) Fil rigide (sans embout)	FINE STRANDED (With ferrule) Fil multibrins (avec embout)	SOLID (No ferrule) Fil rigide (sans embout)	FINE STRANDED (With ferrule) Fil multibrins (avec embout)		
					
AWG18....AWG14 0,75 ... 2,5 mm ²	AWG18....AWG14 0,75 ... 2,5 mm ²	AWG18....AWG14 0,75 ... 2,5 mm ²	AWG18....AWG14 0,75 ... 2,5 mm ²	POZIDRIV 2	Mini 1,2 / Typ 1.5 / Max 2

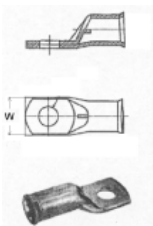
cel3pac [®] Power wiring / Raccordement de puissance				Screwdriver type / Modèle de tournevis	Couple de serrage recommandé Vis M5
Number of wires / Nombre de fils					
1		2		 Recommended tightening torque M5 screw N.m	
SOLID (No ferrule) Fil rigide (sans embout)	FINE STRANDED (With ferrule) Fil multibrins (avec embout)	SOLID (No ferrule) Fil rigide (sans embout)	FINE STRANDED (With ferrule) Fil multibrins (avec embout)		
					
AWG16....AWG8 1,5 ... 10 mm ²	AWG16....AWG10 1,5 ... 6 mm ²	AWG16....AWG8 1,5 ... 10 mm ²	AWG16....AWG10 1,5 ... 6 mm ²	POZIDRIV 2	Mini 2 / Typ 2.4 / Max 3

<p>Power with ring terminal /Puissance avec cosses</p> <p><u>W max =12,6mm</u> 16 mm² (AWG6) 25 mm² (AWG4) 35mm² (AWG2 /AWG3) 50mm² (AWG0 /AWG1)</p>		<p>IP20 flaps / Volets IP20 Flaps are delivered mounted on the relay. Les volets sont montés en standard en usine</p> <p><u>Labels / Etiquettes</u> Marking labels are available, for mounting on flaps. Part number : 1MZ09000 (delivered per 200 parts) Des étiquettes de repérage sont aussi disponibles. Quantités par 200 pièces Montage sur volets (1MZ09000).</p>	
--	---	--	---



Dimensions / Dimensions:

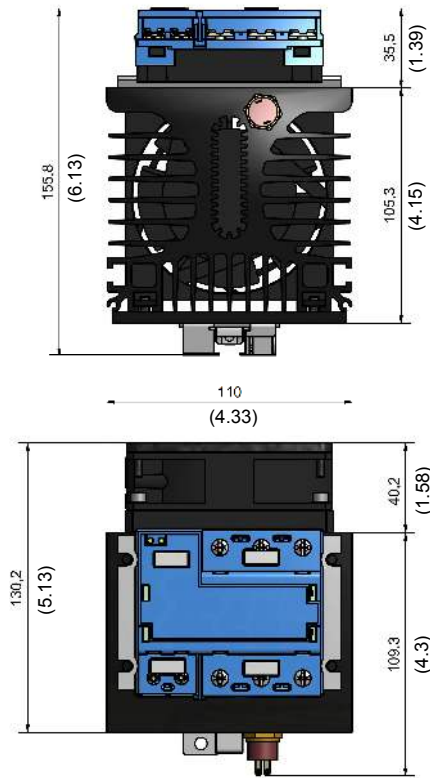

mm
(inches)