

N-Channel Power MOSFET

600V, 2.3A, 4.4Ω

FEATURES

- 100% UIS and Rg tested
- Pb-free plating
- RoHS compliant
- Halogen-free according to IEC 61249-2-21

PRODUCT SUMMARY			
PARAMETER		VALUE	UNIT
V_{DS}		600	V
$R_{DS(on)}$ (max)	$V_{GS} = 10V$	4.4	Ω
Q_g	$V_{GS} = 10V$	9.9	nC

APPLICATIONS

- Lighting
- Charger
- Power Supply
- Switching applications



TO-251 (IPAK)

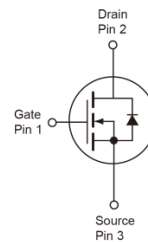
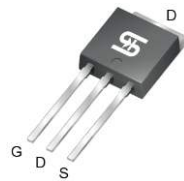

ABSOLUTE MAXIMUM RATINGS ($T_A = 25^\circ\text{C}$ unless otherwise noted)			
PARAMETER	SYMBOL	LIMIT	UNIT
Drain-Source Voltage	V_{DS}	600	V
Gate-Source Voltage	V_{GS}	± 30	V
Continuous Drain Current	I_D	$T_C = 25^\circ\text{C}$	2.3
		$T_C = 100^\circ\text{C}$	1.5
		$T_A = 25^\circ\text{C}$	0.4
Pulsed Drain Current ^(Note 1)	I_{DM}	9.2	A
Single Pulse Avalanche Current ^(Note 2)	I_{AS}	3.3	A
Single Pulse Avalanche Energy ^(Note 2)	E_{AS}	55	mJ
Total Power Dissipation	$T_C = 25^\circ\text{C}$	P_D	60
Operating Junction and Storage Temperature Range	T_J, T_{STG}	- 55 to +150	°C

THERMAL RESISTANCE			
PARAMETER	SYMBOL	MAXIMUM	UNIT
Thermal Resistance – Junction to Case	$R_{\theta JC}$	2.1	°C/W
Thermal Resistance – Junction to Ambient	$R_{\theta JA}$	62	°C/W

Note: $R_{\theta JA}$ is the sum of the junction-to-case and case-to-ambient thermal resistances. The case-thermal reference is defined at the solder mounting surface of the drain pins. $R_{\theta JA}$ is guaranteed by design while $R_{\theta CA}$ is determined by the user's board design. $R_{\theta JA}$ shown below for single device operation on FR-4 PCB with minimum recommended footprint in still air.

ELECTRICAL CHARACTERISTICS ($T_A = 25^\circ\text{C}$ unless otherwise noted)						
PARAMETER	CONDITIONS	SYMBOL	MIN	TYP	MAX	UNIT
Static						
Drain-Source Breakdown Voltage	$V_{GS} = 0\text{V}, I_D = 250\mu\text{A}$	BV_{DSS}	600	--	--	V
Gate Threshold Voltage	$V_{GS} = V_{DS}, I_D = 250\mu\text{A}$	$V_{GS(TH)}$	2.5	2.9	4.5	V
Gate-Source Leakage Current	$V_{GS} = \pm 30\text{V}, V_{DS} = 0\text{V}$	I_{GSS}	--	--	± 100	nA
Drain-Source Leakage Current	$V_{GS} = 0\text{V}, V_{DS} = 600\text{V}$	I_{DSS}	--	--	10	μA
Drain-Source On-State Resistance (Note 3)	$V_{GS} = 10\text{V}, I_D = 1\text{A}$	$R_{DS(on)}$	--	3.9	4.4	Ω
Forward Transfer Conductance	$V_{DS} = 10\text{V}, I_D = 1\text{A}$	g_{fs}	--	2.8	--	S
Dynamic						
Total Gate Charge	$V_{GS} = 10\text{V}, V_{DS} = 480\text{V}, I_D = 2\text{A}$	Q_g	--	9.9	--	nC
Gate-Source Charge		Q_{gs}	--	1.5	--	
Gate-Drain Charge		Q_{gd}	--	4.7	--	
Input Capacitance	$V_{GS} = 0\text{V}, V_{DS} = 25\text{V}, f = 1.0\text{MHz}$	C_{iss}	--	316	--	pF
Output Capacitance		C_{oss}	--	32	--	
Reverse Transfer Capacitance		C_{rss}	--	1	--	
Gate Resistance	$f = 1.0\text{MHz}$	R_g	--	2.8	--	Ω
Switching (Note 4)						
Turn-On Delay Time	$V_{GS} = 10\text{V}, V_{DS} = 300\text{V}, I_D = 2\text{A}, R_G = 25\Omega$	$t_{d(on)}$	--	7.3	--	ns
Rise Time		t_r	--	9.6	--	
Turn-Off Delay Time		$t_{d(off)}$	--	23	--	
Fall Time		t_f	--	18	--	
Source-Drain Diode						
Diode Forward Voltage (Note 3)	$V_{GS} = 0\text{V}, I_S = 2\text{A}$	V_{SD}	--	0.8	1.4	V
Source Current	Integral reverse diode In the MOSFET	I_S	--	--	2.3	A
Source Current (Pulse)		I_{SM}	--	--	9.2	

Notes:

- Pulsed width limited by maximum junction temperature.
- $L = 10\text{mH}, V_{GS} = 10\text{V}, R_G = 25\Omega$, Starting $T_J = 25^\circ\text{C}$.
- Pulse test: Pulse Width $\leq 300\mu\text{s}$, duty cycle $\leq 2\%$.
- Switching time is essentially independent of operating temperature.

ORDERING INFORMATION

ORDERING CODE	PACKAGE	PACKING
TSM2NB60CH C5G	TO-251 (IPAK)	75 pcs / Tube

CHARACTERISTICS CURVES

($T_A = 25^\circ\text{C}$ unless otherwise noted)

Output Characteristics

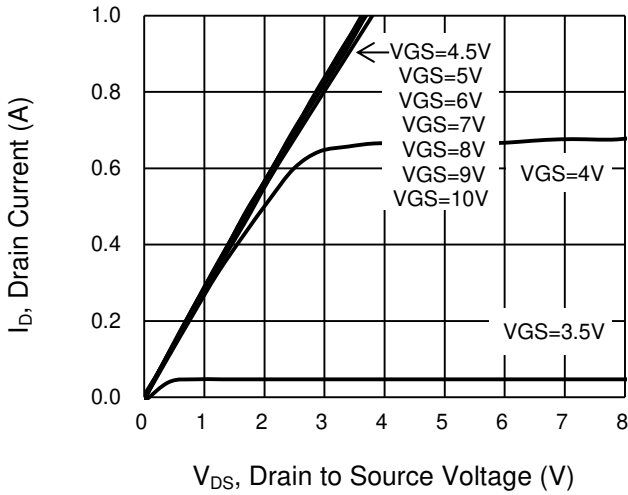

Transfer Characteristics

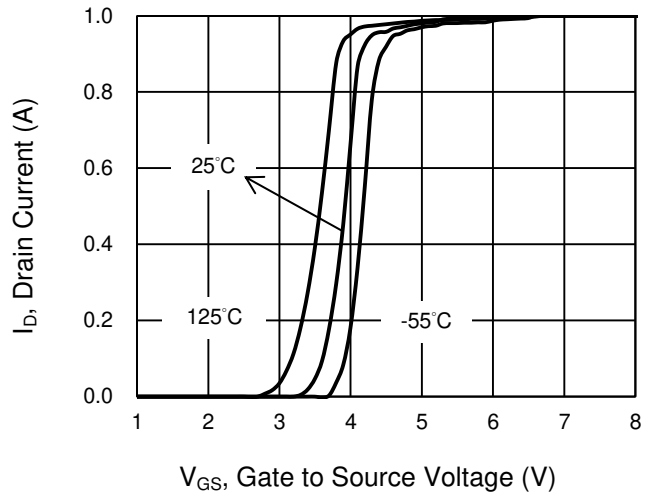

On-Resistance vs. Drain Current

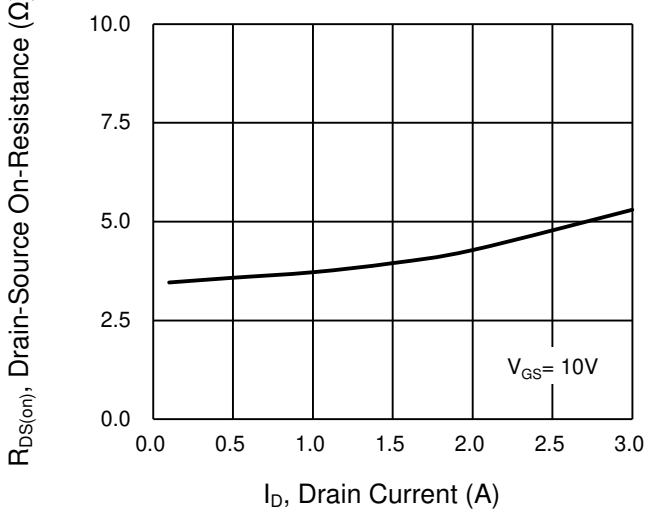

Gate-Source Voltage vs. Gate Charge

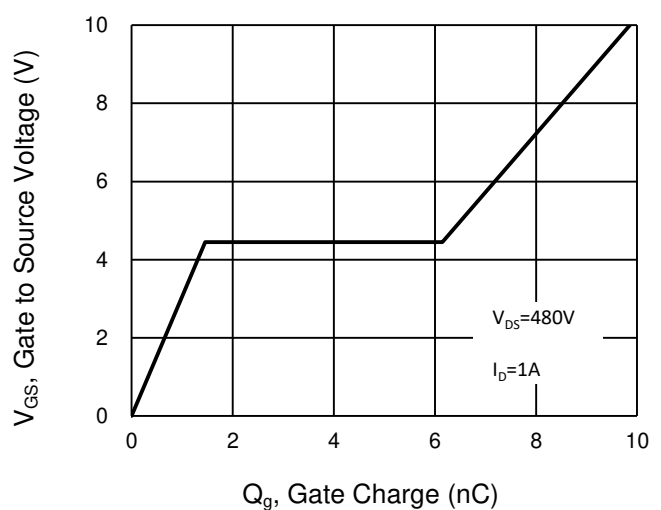

On-Resistance vs. Junction Temperature

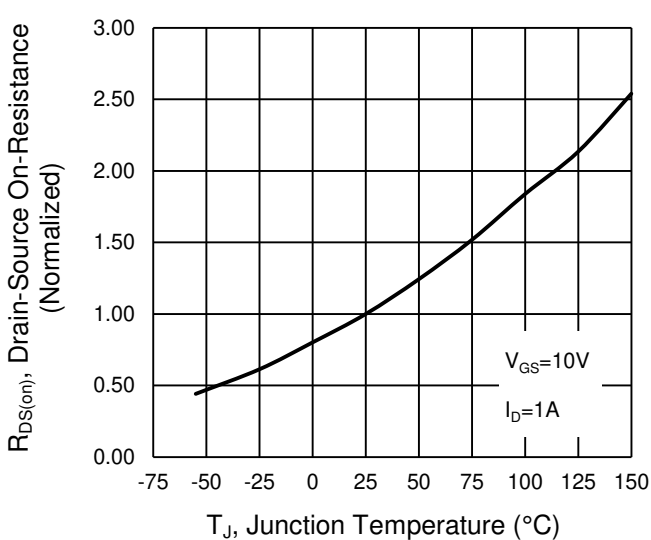

On-Resistance vs. Gate-Source Voltage

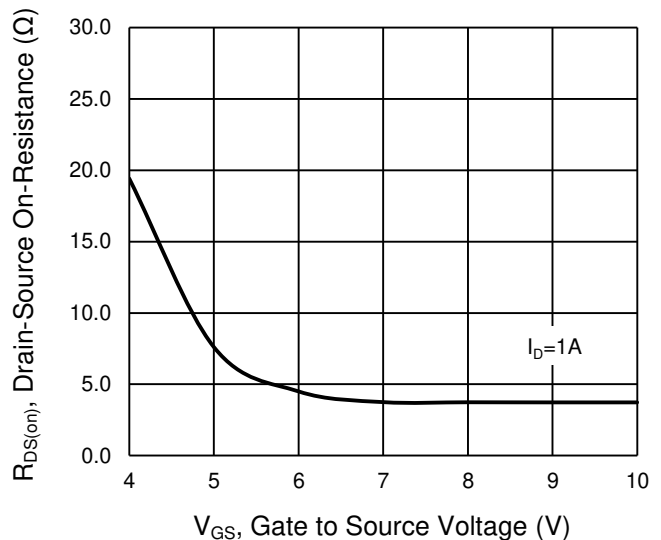

CHARACTERISTICS CURVES

($T_A = 25^\circ\text{C}$ unless otherwise noted)

Capacitance vs. Drain-Source Voltage

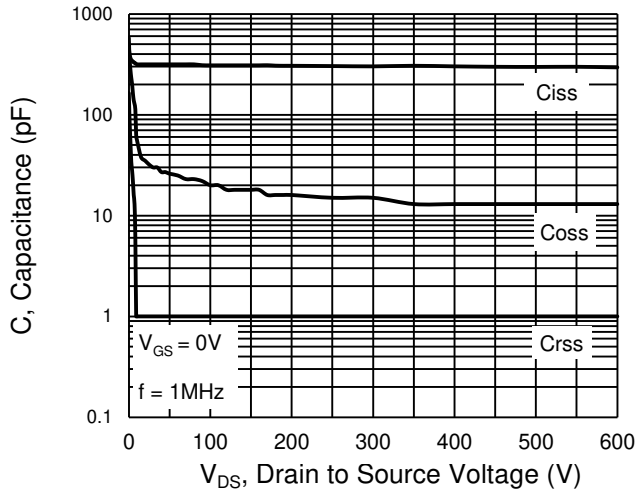

BV_{DSS} vs. Junction Temperature

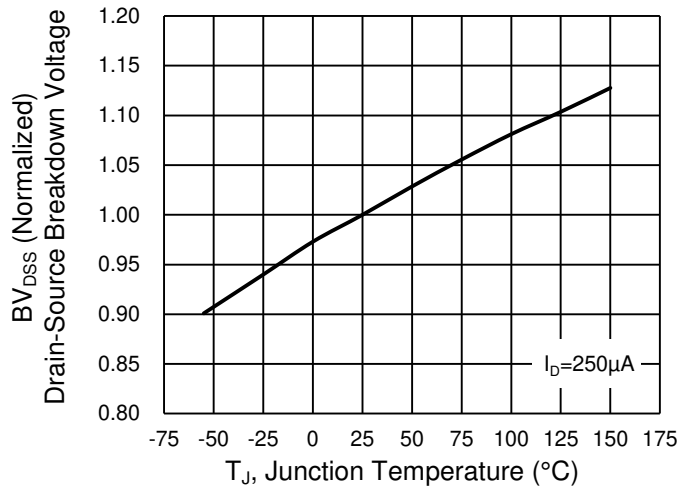

Maximum Safe Operating Area, Junction-to-Case

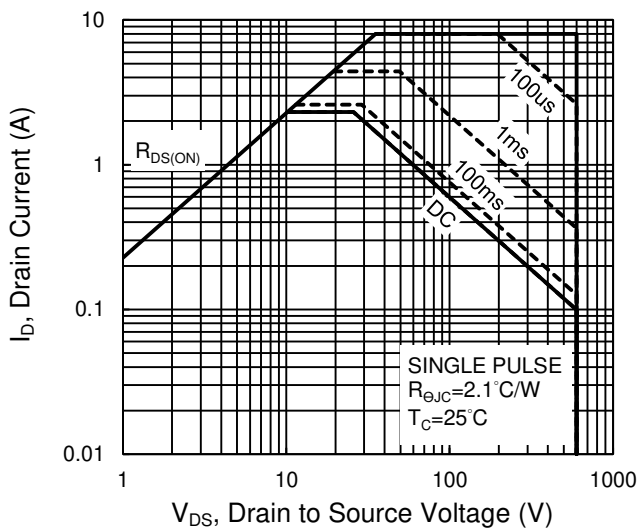

Source-Drain Diode Forward Current vs. Voltage

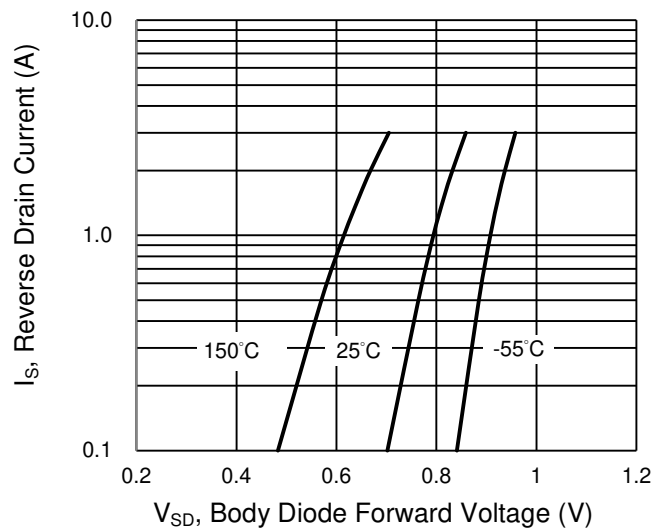

Normalized Thermal Transient Impedance, Junction-to-Case

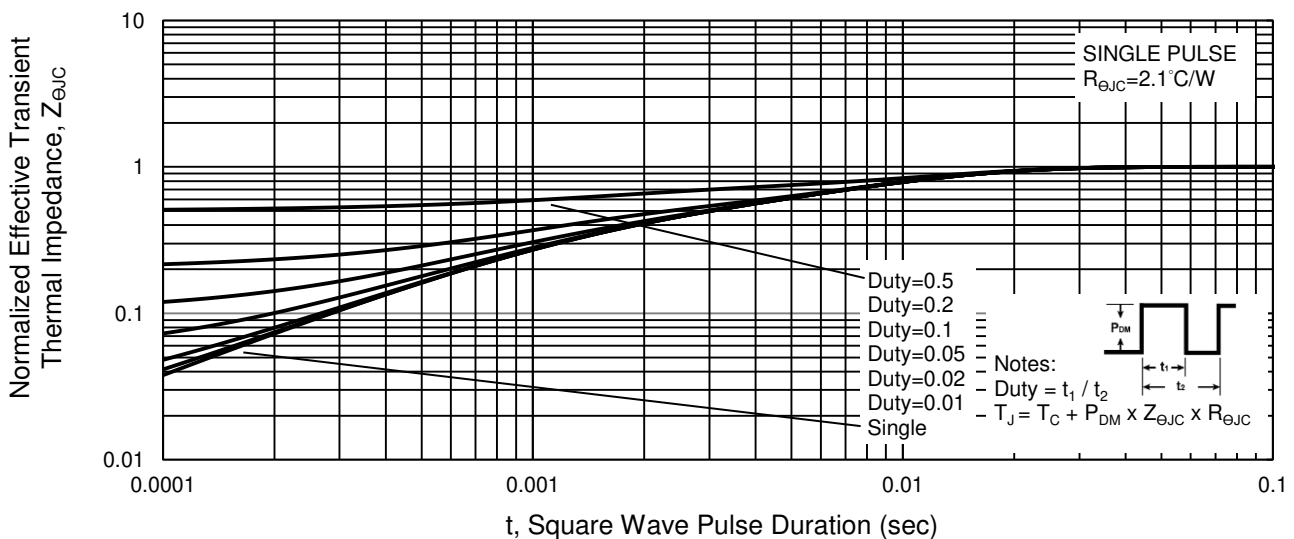

CHARACTERISTICS CURVES

($T_A = 25^\circ\text{C}$ unless otherwise noted)

Power Dissipation

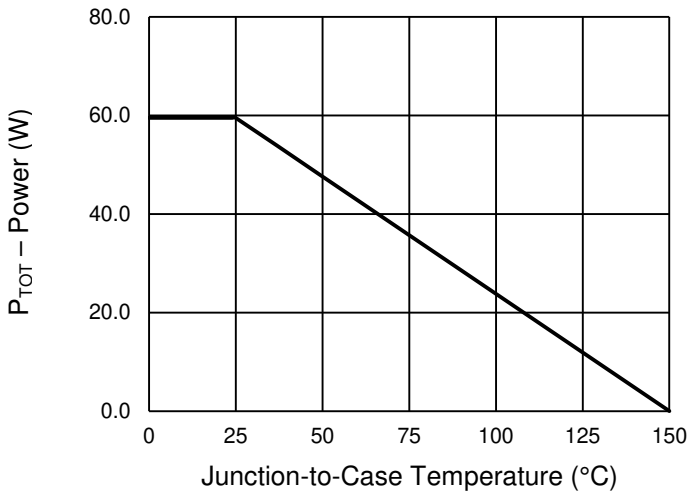

Drain Current

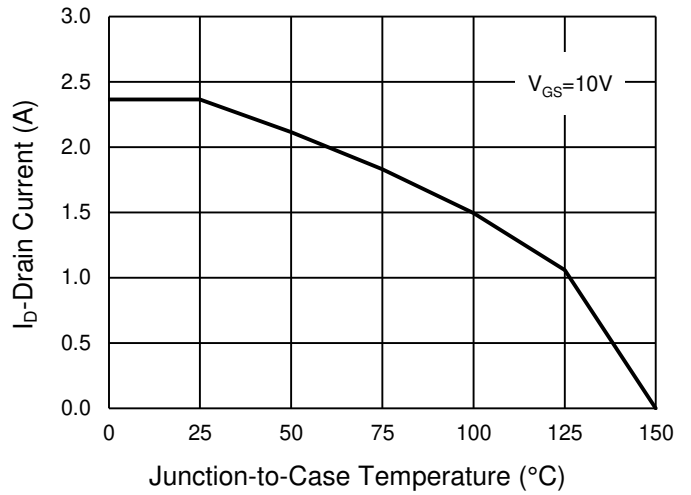

Normalized gate threshold voltage vs Temperature

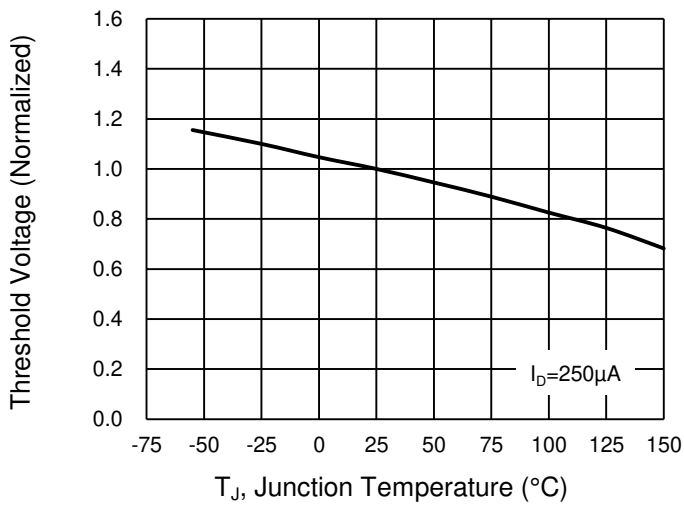

PACKAGE OUTLINE DIMENSIONS (Unit: Millimeters)

TO-251 (IPAK)

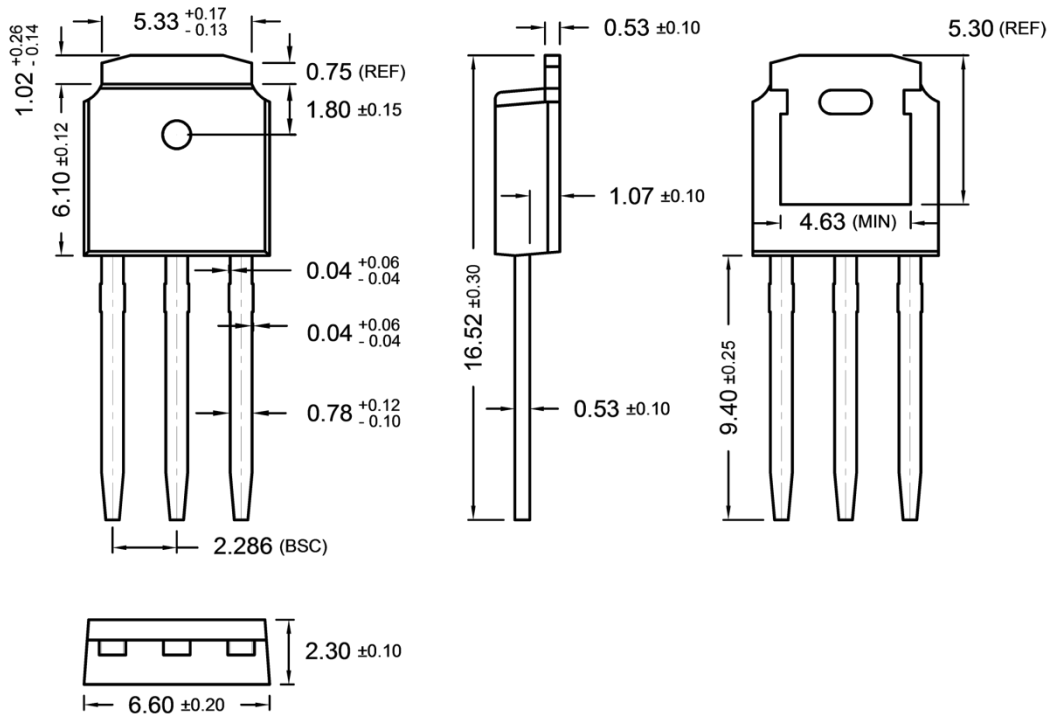

MARKING DIAGRAM

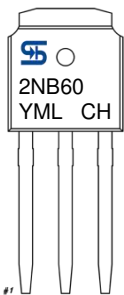

- Y** = Year Code
- M** = Month Code
 - O** =Jan **P** =Feb **Q** =Mar **R** =Apr
 - S** =May **T** =Jun **U** =Jul **V** =Aug
 - W** =Sep **X** =Oct **Y** =Nov **Z** =Dec
- L** = Lot Code (1~9, A~Z)

Notice

Specifications of the products displayed herein are subject to change without notice. TSC or anyone on its behalf, assumes no responsibility or liability for any errors or inaccuracies.

Purchasers are solely responsible for the choice, selection, and use of TSC products and TSC assumes no liability for application assistance or the design of Purchasers' products.

Information contained herein is intended to provide a product description only. No license, express or implied, to any intellectual property rights is granted by this document. Except as provided in TSC's terms and conditions of sale for such products, TSC assumes no liability whatsoever, and disclaims any express or implied warranty, relating to sale and/or use of TSC products including liability or warranties relating to fitness for a particular purpose, merchantability, or infringement of any patent, copyright, or other intellectual property right.

The products shown herein are not designed for use in medical, life-saving, or life-sustaining applications. Customers using or selling these products for use in such applications do so at their own risk and agree to fully indemnify TSC for any damages resulting from such improper use or sale.