

2.4 GHz External WiFi Antenna



AEACAC025009-S2400

25.9 x Ø9.5mm



RoHS/RoHS II Compliant

MSL = N/A: NOT APPLICABLE

FEATURES

- Operates in 2400 MHz
- Gain of 2dBi
- Input power 10W
- VSWR \leq 2.5

APPLICATIONS

- Wifi
- ISM Applications
- Portable Devices
- Set-Top Boxes
- Network Devices

ELECTRICAL SPECIFICATIONS

Item	min	Typ.	Max.	Units	Note
Frequency Range		2400~2483.5		MHz	
Bandwidth		83.5			
VSWR			2.5		
Polarization Model		Linear			
Impedance		50		Ω	
Gain		2		dBi	
Operating Temperature	-40		+85	$^{\circ}\text{C}$	
Input Power			10	W	

RETURN - LOSS CHARACTERISTICS

S11 Return-Loss

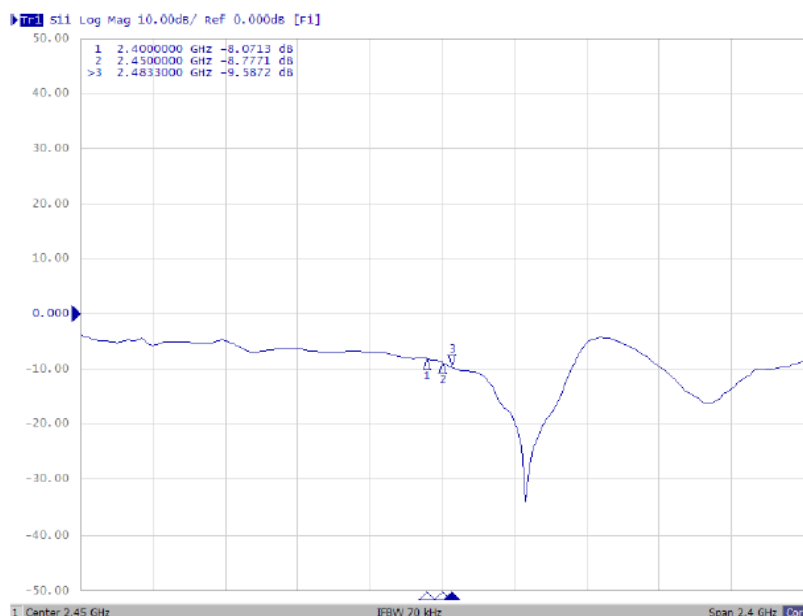

5101 Hidden Creek Ln Spicewood TX 78669
Phone: 512-371-6159 | Fax: 512-351-8858
For terms and conditions of sales, please visit:
www.abracon.com

REVISED: 06.07.2019

ABRACON IS
ISO9001-2015
CERTIFIED

2.4 GHz External WiFi Antenna



AEACAC025009-S2400



25.9 x Ø9.5mm
RoHS/RoHS II Compliant

MSL = N/A: NOT APPLICABLE

RADIATION PATTERNS

Antenna 2D Patterns
XY Plane

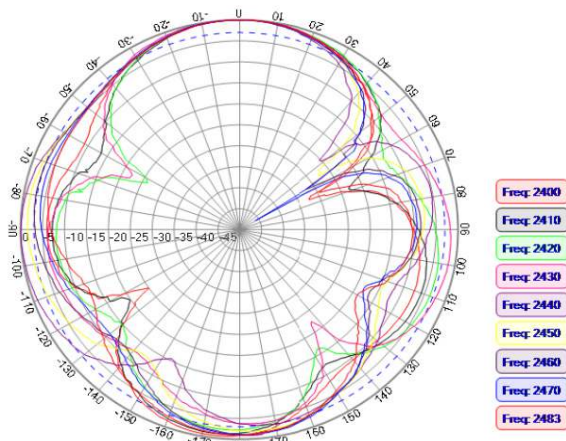

XZ Plane

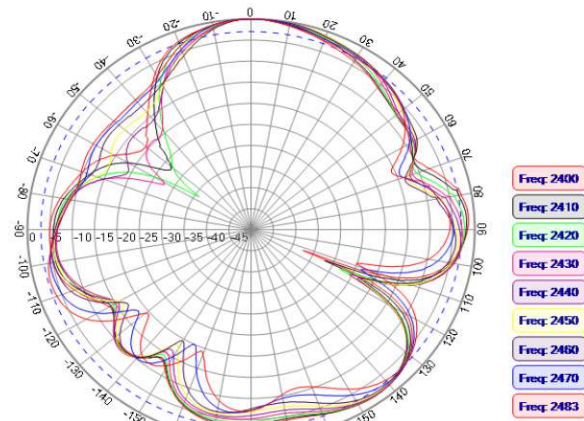

YZ Plane

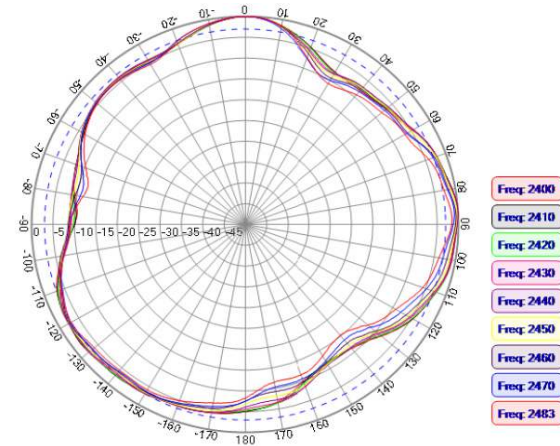

Antenna 3D Patterns
2400 MHz

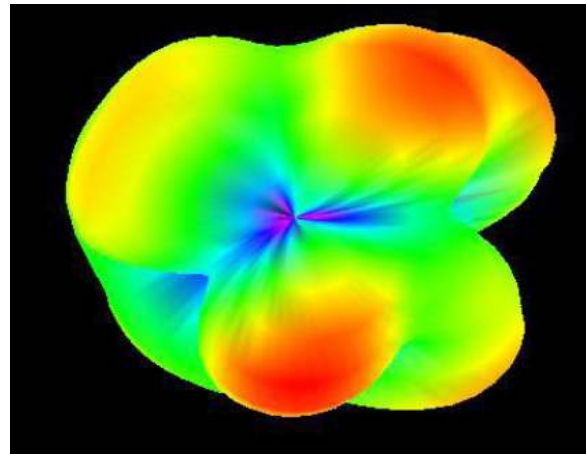

2450 MHz

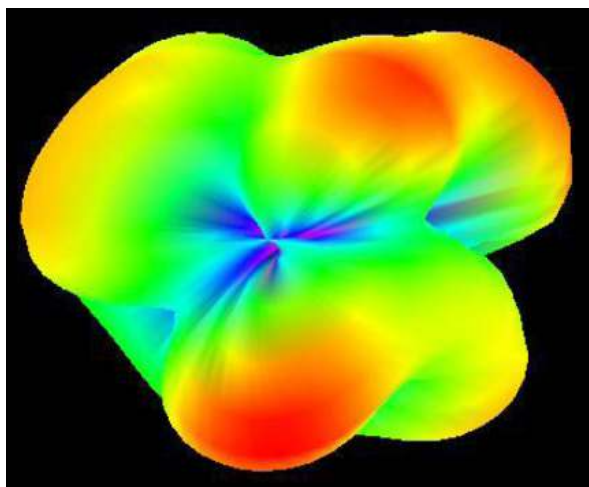

2483 MHz

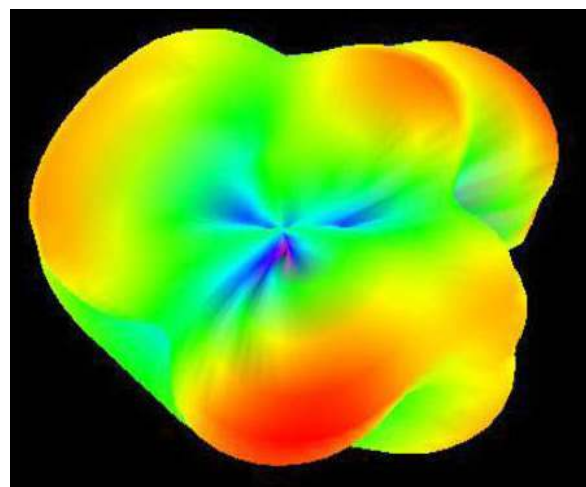

Frequency (MHz)	2400	2450	2483
Peak Gain (dBi)	1.83	1.7	1.4
Efficiency (%)	62	63	65

2.4 GHz External WiFi Antenna



AEACAC025009-S2400

 **RoHS/RoHS II Compliant**
 25.9 x Ø9.5mm
 MSL = N/A: NOT APPLICABLE

DIMENSIONS

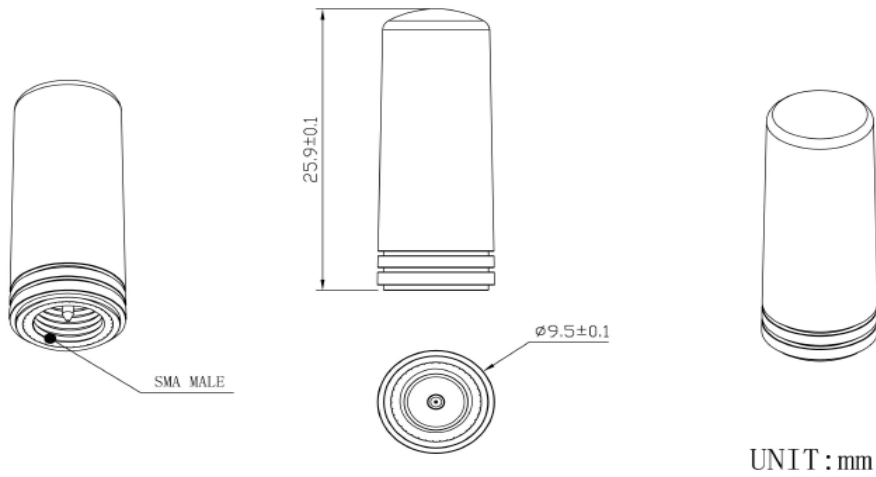

Parameters	Description
RF Connector	SMA Male
Mounting Type	Connector mount

PACKAGING:

Each 370 x 360 x 165 mm size carton includes 1000 pcs antenna, 5kgs/carton.

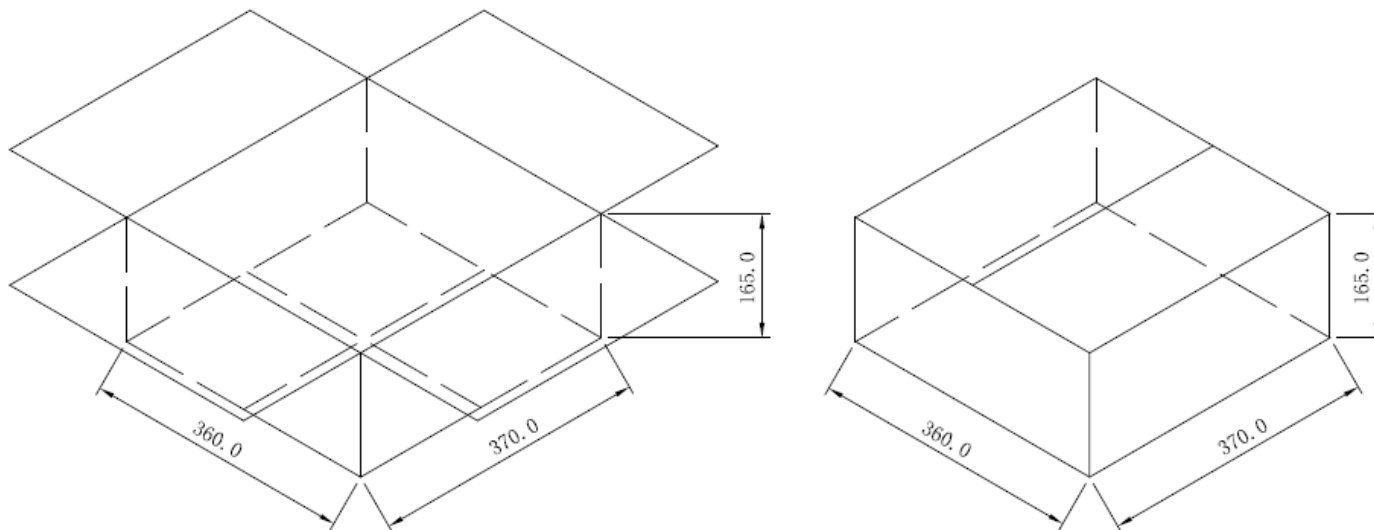

Unit: mm