

# NCP512

## 80 mA CMOS Low Iq Voltage Regulator

The NCP512 series of fixed output linear regulators are designed for handheld communication equipment and portable battery powered applications which require low quiescent. The NCP512 series features an ultra-low quiescent current of 40  $\mu$ A. Each device contains a voltage reference unit, an error amplifier, a PMOS power transistor, resistors for setting output voltage, current limit, and temperature limit protection circuits.

The NCP512 has been designed to be used with low cost ceramic capacitors. The device is housed in the micro-miniature SC70-5 surface mount package. Standard voltage versions are 1.3, 1.5, 1.8, 2.2, 2.5, 2.7, 2.8, 3.0, 3.1, 3.3, and 5.0 V. Other voltages are available in 100 mV steps.

### Features

- Low Quiescent Current of 40  $\mu$ A Typical
- Low Dropout Voltage of 180 mV at 80 mA and 3.0 V  $V_{out}$
- Low Output Voltage Option
- Output Voltage Accuracy of 2.0%
- Industrial Temperature Range of  $-40^{\circ}$ C to  $85^{\circ}$ C
- Pb-Free Packages are Available

### Typical Applications

- Cellular Phones
- Battery Powered Consumer Products
- Hand-Held Instruments
- Camcorders and Cameras

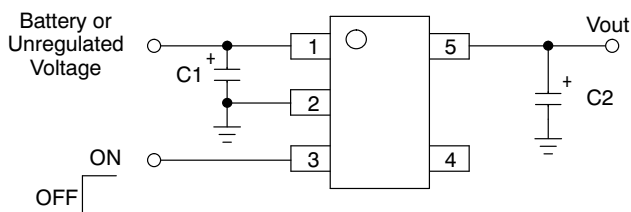

This device contains 86 active transistors

Figure 1. Typical Application Diagram



ON Semiconductor®

<http://onsemi.com>

### MARKING DIAGRAM

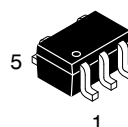

SC70-5/SC-88A/  
SOT-353  
SQ SUFFIX  
CASE 419A

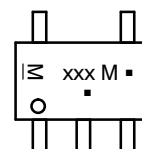

xxx = Device Code  
M = Date Code\*  
▪ = Pb-Free Package

(Note: Microdot may be in either location)

\*Date Code orientation and/or position may vary depending upon manufacturing location.

### PIN CONNECTIONS

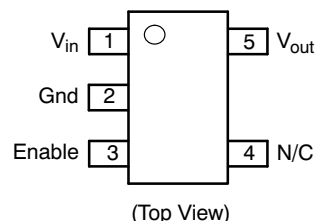

### ORDERING INFORMATION

See detailed ordering and shipping information in the package dimensions section on page 8 of this data sheet.

# NCP512

## PIN FUNCTION DESCRIPTION

Pin No.	Pin Name	Description
1	Vin	Positive power supply input voltage.
2	Gnd	Power supply ground.
3	Enable	This input is used to place the device into low-power standby. When this input is pulled low, the device is disabled. If this function is not used, Enable should be connected to Vin.
4	N/C	No internal connection.
5	Vout	Regulated output voltage.

## MAXIMUM RATINGS

Rating	Symbol	Value	Unit
Input Voltage	$V_{in}$	0 to 6.0	V
Enable Voltage	Enable	-0.3 to $V_{in} + 0.3$	V
Output Voltage	$V_{out}$	-0.3 to $V_{in} + 0.3$	V
Power Dissipation and Thermal Characteristics Power Dissipation Thermal Resistance, Junction-to-Ambient	$P_D$ $R_{\theta JA}$	Internally Limited 400	W °C/W
Operating Junction Temperature	$T_J$	+125	°C
Operating Ambient Temperature	$T_A$	-40 to +85	°C
Storage Temperature	$T_{stg}$	-55 to +150	°C

Stresses exceeding Maximum Ratings may damage the device. Maximum Ratings are stress ratings only. Functional operation above the Recommended Operating Conditions is not implied. Extended exposure to stresses above the Recommended Operating Conditions may affect device reliability.

1. This device series contains ESD protection and exceeds the following tests:  
Human Body Model 2000 V per MIL-STD-883, Method 3015  
Machine Model Method 200 V
2. Latch-up capability (85°C)  $\pm 200$  mA DC with trigger voltage.

# NCP512

**ELECTRICAL CHARACTERISTICS** ( $V_{in} = V_{out(nom.)} + 1.0\text{ V}$ ,  $V_{enable} = V_{in}$ ,  $C_{in} = 1.0\ \mu\text{F}$ ,  $C_{out} = 1.0\ \mu\text{F}$ ,  $T_J = 25^\circ\text{C}$ , unless otherwise noted.)

Characteristic	Symbol	Min	Typ	Max	Unit
Output Voltage ( $T_A = 25^\circ\text{C}$ , $I_{out} = 10\text{ mA}$ )	$V_{out}$				V
1.3 V		1.261	1.3	1.339	
1.5 V		1.455	1.5	1.545	
1.8 V		1.746	1.8	1.854	
2.2 V		2.134	2.2	2.266	
2.5 V		2.425	2.5	2.575	
2.7 V		2.646	2.7	2.754	
2.8 V		2.744	2.8	2.856	
3.0 V		2.94	3.0	3.06	
3.1 V		3.038	3.1	3.162	
3.3 V	3.234	3.3	3.366		
5.0 V	4.900	5.0	5.100		
Output Voltage ( $T_A = -40^\circ\text{C}$ to $85^\circ\text{C}$ , $I_{out} = 10\text{ mA}$ )	$V_{out}$				V
1.3 V		1.261	1.3	1.339	
1.5 V		1.455	1.5	1.545	
1.8 V		1.746	1.8	1.854	
2.2 V		2.134	2.2	2.266	
2.5 V		2.425	2.5	2.575	
2.7 V		2.619	2.7	2.781	
2.8 V		2.716	2.8	2.884	
3.0 V		2.910	3.0	3.09	
3.1 V		3.007	3.1	3.193	
3.3 V	3.201	3.3	3.399		
5.0 V	4.900	5.0	5.100		
Line Regulation ( $I_{out} = 10\text{ mA}$ )	$Reg_{line}$				mV/V
1.3 V–4.4 V ( $V_{in} = V_{out(nom.)} + 1.0\text{ V}$ to 6.0 V)		–	1.0	3.0	
4.5 V–5.0 V ( $V_{in} = 5.5\text{ V}$ to 6.0 V)		–	1.0	3.0	
Load Regulation ( $I_{out} = 1.0\text{ mA}$ to 80 mA)	$Reg_{load}$	–	0.3	0.8	mV/mA
Output Current ( $V_{out} = (V_{out}$ at $I_{out} = 80\text{ mA}) - 3\%$ )	$I_{o(nom.)}$				mA
1.3 V–3.9 V ( $V_{in} = V_{out(nom.)} + 2.0\text{ V}$ )		80	200	–	
4.0 V–5.0 V ( $V_{in} = 6.0\text{ V}$ )		80	200	–	
Dropout Voltage ( $T_A = -40^\circ\text{C}$ to $85^\circ\text{C}$ , $I_{out} = 80\text{ mA}$ , Measured at $V_{out} = V_{out(nom)} - 3.0\%$ )	$V_{in} - V_{out}$				mV
1.3 V		–	520	700	
1.5 V		–	450	550	
1.8 V		–	350	450	
2.2 V		–	240	300	
2.5 V		–	220	300	
2.7 V		–	200	300	
2.8 V		–	200	300	
3.0 V		–	180	300	
3.1 V		–	170	300	
3.3 V	–	160	300		
5.0 V	–	120	300		
Ground Current (Enable Input = $V_{in}$ , $I_{out} = 1.0\text{ mA}$ to $I_{o(nom.)}$ )	$I_{GND}$	–	40	90	$\mu\text{A}$
Quiescent Current ( $T_A = -40^\circ\text{C}$ to $85^\circ\text{C}$ )	$I_Q$				$\mu\text{A}$
(Enable Input = 0 V)		–	0.1	1.0	
(Enable Input = $V_{in}$ , $I_{out} = 1.0\text{ mA}$ to $I_{o(nom.)}$ )		–	40	90	
Output Short Circuit Current ( $V_{out} = 0\text{ V}$ )	$I_{out(max)}$				mA
1.3 V–3.9 V ( $V_{in} = V_{out(nom.)} + 2.0\text{ V}$ )		150	250	400	
4.0 V–5.0 V ( $V_{in} = 6.0\text{ V}$ )		150	250	400	
Output Voltage Noise ( $f = 100\text{ Hz}$ to $100\text{ kHz}$ , $I_{out} = 30\text{ mA}$ , $C_{out} = 1\ \mu\text{F}$ )	$V_n$	–	180	–	$\mu\text{Vrms}$
Ripple Rejection ( $f = 1.0\text{ kHz}$ , 60 mA)	RR	–	50	–	dB
Enable Input Threshold Voltage	$V_{th(en)}$				V
(Voltage Increasing, Output Turns On, Logic High)		1.3	–	–	
(Voltage Decreasing, Output Turns Off, Logic Low)		–	–	0.3	
Output Voltage Temperature Coefficient	$T_C$	–	$\pm 100$	–	ppm/ $^\circ\text{C}$

3. Maximum package power dissipation limits must be observed.

$$PD = \frac{T_{J(max)} - T_A}{R_{\theta JA}}$$

4. Low duty cycle pulse techniques are used during testing to maintain the junction temperature as close to ambient as possible.

# NCP512

## TYPICAL CHARACTERISTICS

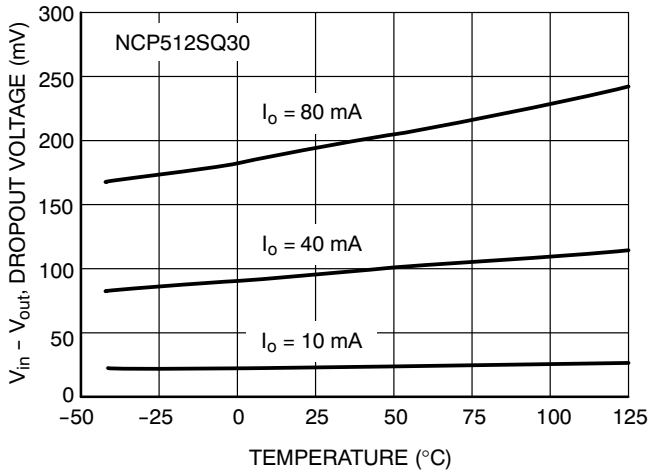

Figure 2. Dropout Voltage vs. Temperature

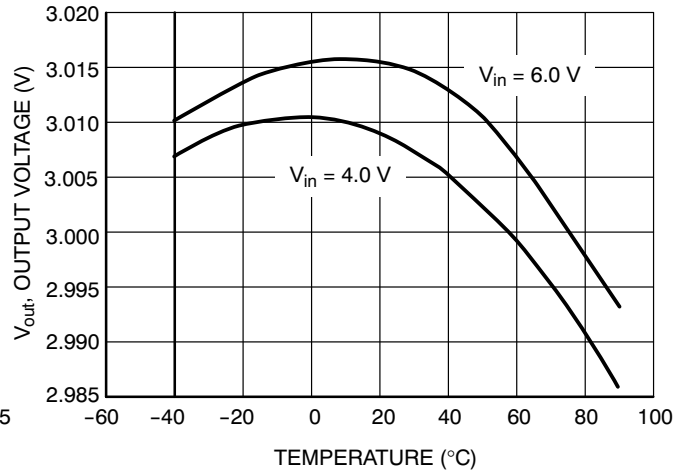

Figure 3. Output Voltage vs. Temperature

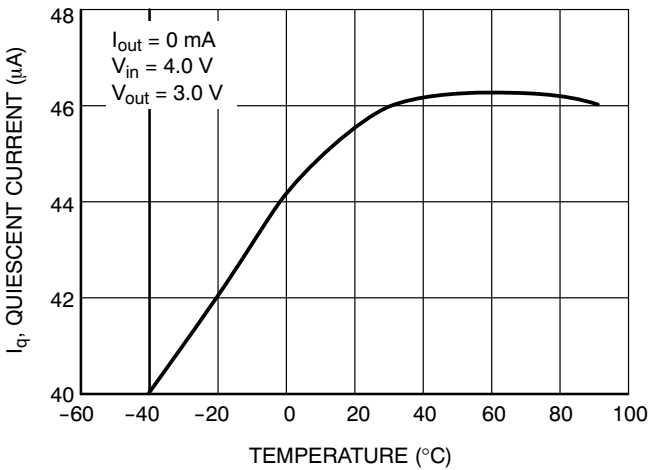

Figure 4. Quiescent Current vs. Temperature

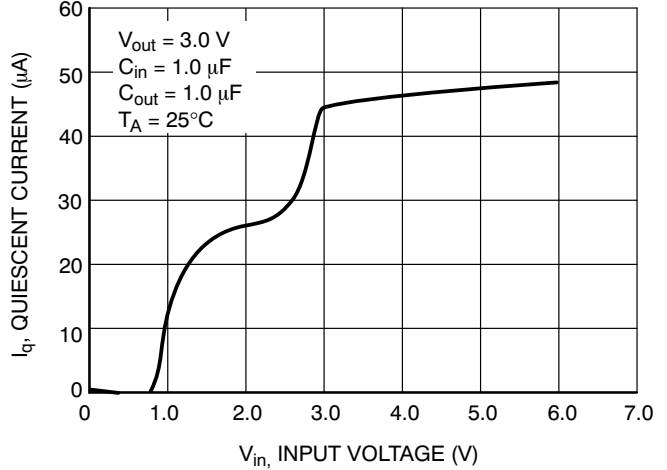

Figure 5. Quiescent Current vs. Input Voltage

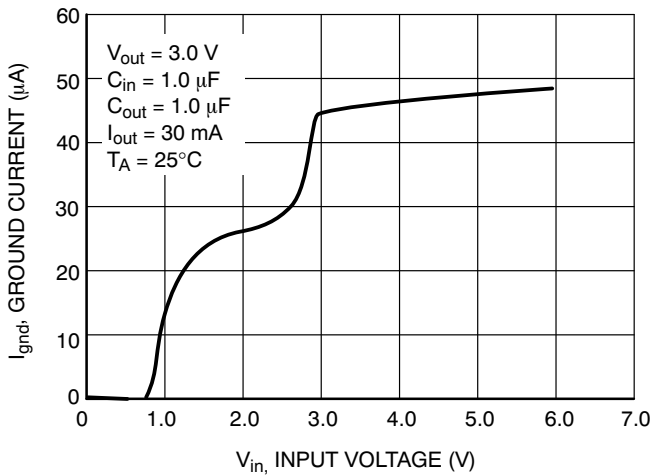

Figure 6. Ground Pin Current vs. Input Voltage

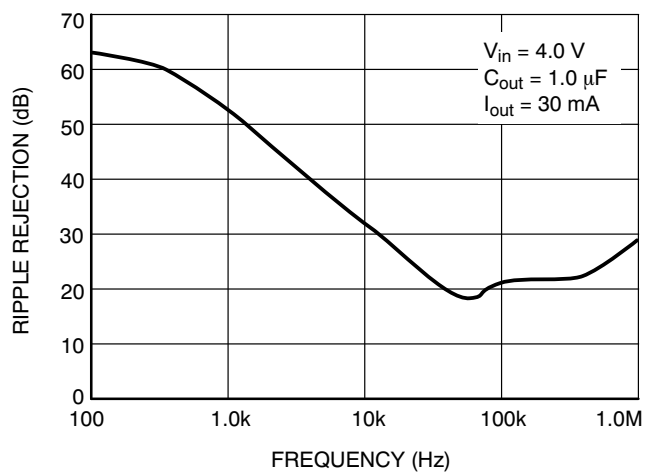

Figure 7. Ripple Rejection vs. Frequency

# NCP512

## TYPICAL CHARACTERISTICS

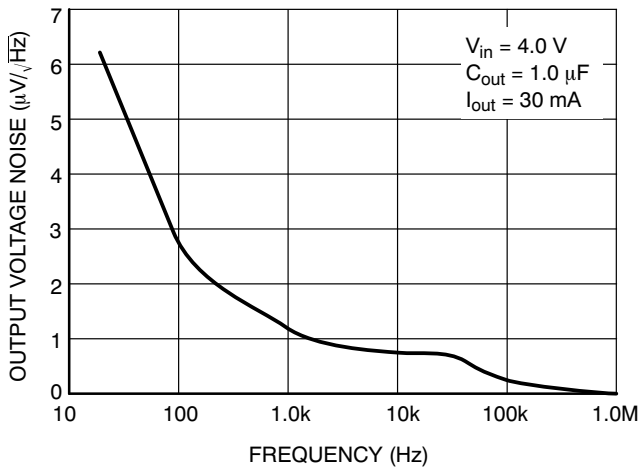

Figure 8. Output Noise Density

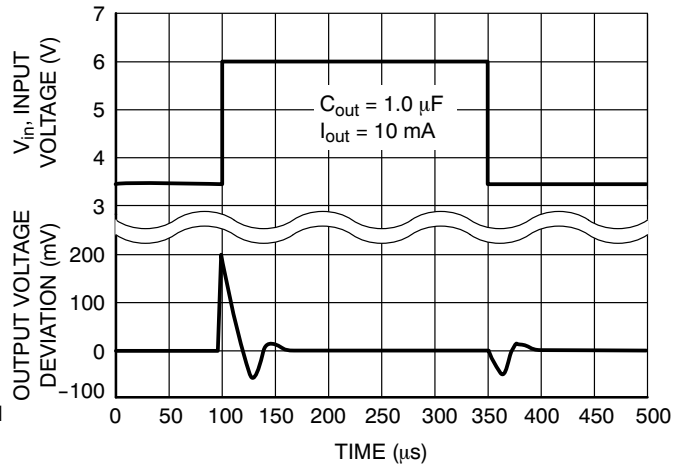

Figure 9. Line Transient Response

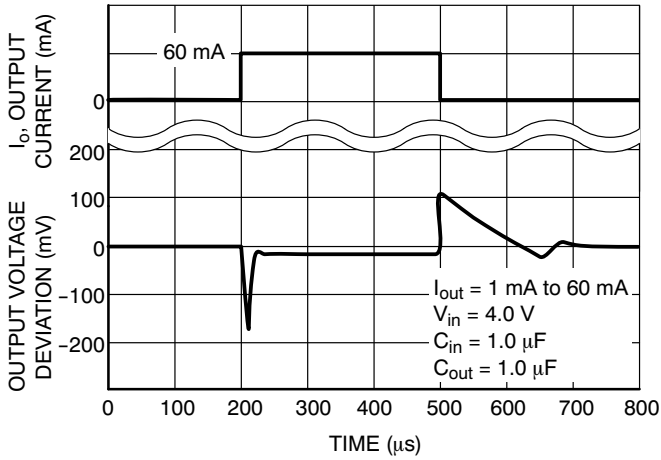

Figure 10. Load Transient Response

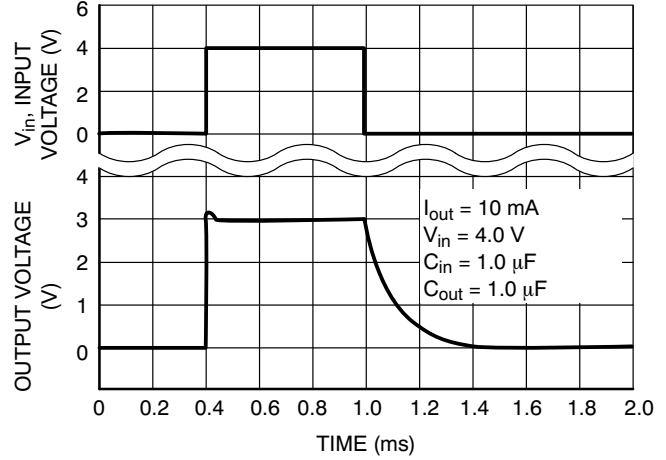

Figure 11. Turn-on Response

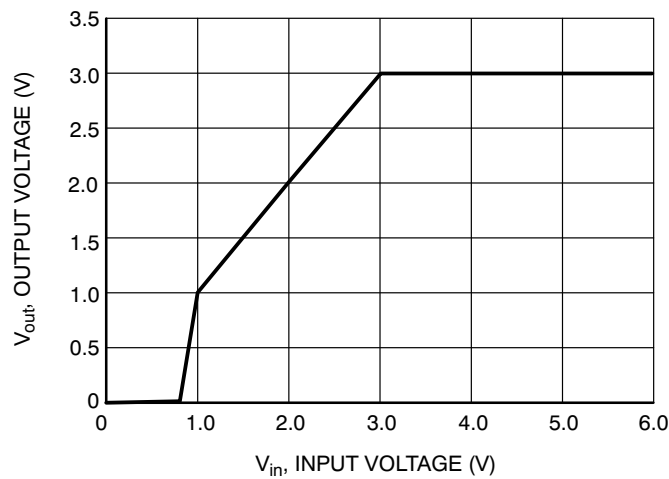

Figure 12. Output Voltage vs. Input Voltage

## DEFINITIONS

### **Load Regulation**

The change in output voltage for a change in output current at a constant temperature.

### **Dropout Voltage**

The input/output differential at which the regulator output no longer maintains regulation against further reductions in input voltage. Measured when the output drops 3.0% below its nominal. The junction temperature, load current, and minimum input supply requirements affect the dropout level.

### **Maximum Power Dissipation**

The maximum total dissipation for which the regulator will operate within its specifications.

### **Quiescent Current**

The quiescent current is the current which flows through the ground when the LDO operates without a load on its output: internal IC operation, bias, etc. When the LDO becomes loaded, this term is called the Ground current. It is actually the difference between the input current (measured through the LDO input pin) and the output current.

### **Line Regulation**

The change in output voltage for a change in input voltage. The measurement is made under conditions of low dissipation or by using pulse technique such that the average chip temperature is not significantly affected.

### **Line Transient Response**

Typical over and undershoot response when input voltage is excited with a given slope.

### **Thermal Protection**

Internal thermal shutdown circuitry is provided to protect the integrated circuit in the event that the maximum junction temperature is exceeded. When activated at typically 160°C, the regulator turns off. This feature is provided to prevent failures from accidental overheating.

### **Maximum Package Power Dissipation**

The maximum power package dissipation is the power dissipation level at which the junction temperature reaches its maximum operating value, i.e. 125°C. Depending on the ambient power dissipation and thus the maximum available output current.

# NCP512

## APPLICATIONS INFORMATION

A typical application circuit for the NCP512 series is shown in Figure 1, front page.

### Input Decoupling (C1)

A 1.0  $\mu\text{F}$  capacitor either ceramic or tantalum is recommended and should be connected close to the NCP512 package. Higher values and lower ESR will improve the overall line transient response.

TDK capacitor: C2012X5R1C105K, or C1608X5R1A105K

### Output Decoupling (C2)

The NCP512 is a stable regulator and does not require any specific Equivalent Series Resistance (ESR) or a minimum output current. Capacitors exhibiting ESRs ranging from a few  $\text{m}\Omega$  up to  $5.0\ \Omega$  can thus safely be used. The minimum decoupling value is 1.0  $\mu\text{F}$  and can be augmented to fulfill stringent load transient requirements. The regulator accepts ceramic chip capacitors as well as tantalum capacitors. Larger values improve noise rejection and load regulation transient response.

TDK capacitor: C2012X5R1C105K, C1608X5R1A105K, or C3216X7R1C105K

### Enable Operation

The enable pin will turn on the regulator when pulled high and turn off the regulator when pulled low. These limits of threshold are covered in the electrical specification section of this data sheet. If the enable is not used then the pin should be connected to  $V_{\text{in}}$ .

### Hints

Please be sure the  $V_{\text{in}}$  and Gnd lines are sufficiently wide. When the impedance of these lines is high, there is a chance to pick up noise or cause the regulator to malfunction.

Set external components, especially the output capacitor, as close as possible to the circuit, and make leads as short as possible.

### Thermal

As power across the NCP512 increases, it might become necessary to provide some thermal relief. The maximum power dissipation supported by the device is dependent upon board design and layout. Mounting pad configuration on the PCB, the board material and also the ambient temperature effect the rate of temperature rise for the part. This is stating that when the NCP512 has good thermal conductivity through the PCB, the junction temperature will be relatively low with high power dissipation applications.

The maximum dissipation the package can handle is given by:

$$PD = \frac{T_{J(\text{max})} - T_A}{R_{\theta JA}}$$

If junction temperature is not allowed above the maximum  $125^\circ\text{C}$ , then the NCP512 can dissipate up to 250 mW @  $25^\circ\text{C}$ .

The power dissipated by the NCP512 can be calculated from the following equation:

$$P_{\text{tot}} = [V_{\text{in}} * I_{\text{gnd}} (I_{\text{out}})] + [V_{\text{in}} - V_{\text{out}}] * I_{\text{out}}$$

or

$$V_{\text{inMAX}} = \frac{P_{\text{tot}} + V_{\text{out}} * I_{\text{out}}}{I_{\text{gnd}} + I_{\text{out}}}$$

If an 80 mA output current is needed then the ground current from the data sheet is 40  $\mu\text{A}$ . For an NCP512 (3.0 V), the maximum input voltage will then be 6.12 V.

# NCP512

## ORDERING INFORMATION

Device	Nominal Output Voltage*	Marking	Package	Shipping†
NCP512SQ13T1G	1.3	LIW	SC-88A (SOT-353) (Pb-Free)	3000 Units/ 7" Tape & Reel
NCP512SQ15T1	1.5	LCK	SC-88A (SOT-353)	
NCP512SQ15T1G	1.5	LCK	SC-88A (SOT-353) (Pb-Free)	
NCP512SQ18T1	1.8	LCL	SC-88A (SOT-353)	
NCP512SQ18T1G	1.8	LCL	SC-88A (SOT-353) (Pb-Free)	
NCP512SQ22T1G	2.2	LIA	SC-88A (SOT-353) (Pb-Free)	
NCP512SQ25T1	2.5	LCM	SC-88A (SOT-353)	
NCP512SQ25T1G	2.5	LCM	SC-88A (SOT-353) (Pb-Free)	
NCP512SQ27T1	2.7	LCN	SC-88A (SOT-353)	
NCP512SQ27T1G	2.7	LCN	SC-88A (SOT-353) (Pb-Free)	
NCP512SQ28T1	2.8	LCO	SC-88A (SOT-353)	
NCP512SQ28T1G	2.8	LCO	SC-88A (SOT-353) (Pb-Free)	
NCP512SQ30T1	3.0	LCP	SC-88A (SOT-353)	
NCP512SQ30T1G	3.0	LCP	SC-88A (SOT-353) (Pb-Free)	
NCP512SQ31T1	3.1	LFO	SC-88A (SOT-353)	
NCP512SQ31T1G	3.1	LFO	SC-88A (SOT-353) (Pb-Free)	
NCP512SQ33T1	3.3	LCQ	SC-88A (SOT-353)	
NCP512SQ33T1G	3.3	LCQ	SC-88A (SOT-353) (Pb-Free)	
NCP512SQ50T1	5.0	LCR	SC-88A (SOT-353)	
NCP512SQ50T1G	5.0	LCR	SC-88A (SOT-353) (Pb-Free)	

\*Additional voltages in 100 mV steps are available upon request by contacting your ON Semiconductor representative.

†For information on tape and reel specifications, including part orientation and tape sizes, please refer to our Tape and Reel Packaging Specification Brochure, BRD8011/D.



# NCP512

## PACKAGE DIMENSIONS

SC-88A/SOT-353/SC70-5  
SQ SUFFIX  
CASE 419A-02  
ISSUE J

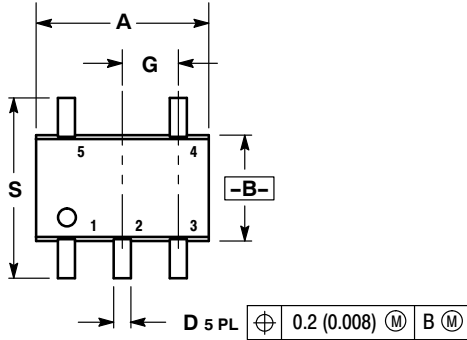

**NOTES:**

1. DIMENSIONING AND TOLERANCING PER ANSI Y14.5M, 1982.
2. CONTROLLING DIMENSION: INCH.
3. 419A-01 OBSOLETE. NEW STANDARD 419A-02.
4. DIMENSIONS A AND B DO NOT INCLUDE MOLD FLASH, PROTRUSIONS, OR GATE BURRS.

DIM	INCHES		MILLIMETERS	
	MIN	MAX	MIN	MAX
A	0.071	0.087	1.80	2.20
B	0.045	0.053	1.15	1.35
C	0.031	0.043	0.80	1.10
D	0.004	0.012	0.10	0.30
G	0.026 BSC		0.65 BSC	
H	---	0.004	---	0.10
J	0.004	0.010	0.10	0.25
K	0.004	0.012	0.10	0.30
N	0.008 REF		0.20 REF	
S	0.079	0.087	2.00	2.20

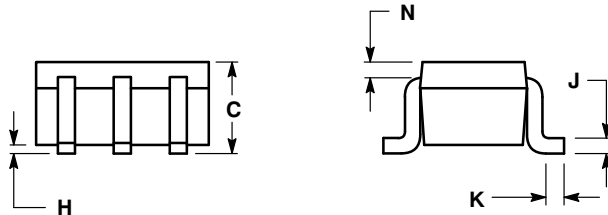

### SOLDERING FOOTPRINT\*

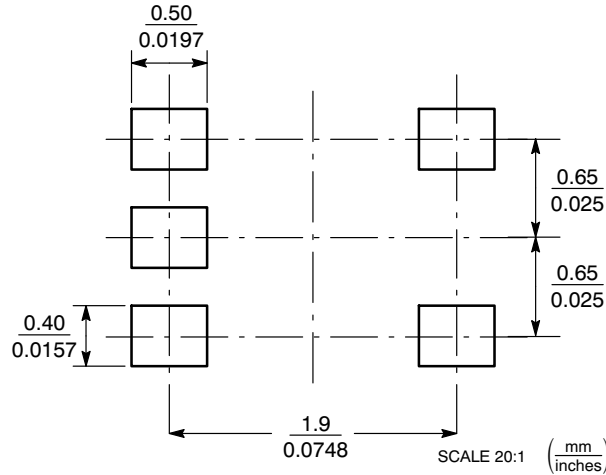

\*For additional information on our Pb-Free strategy and soldering details, please download the ON Semiconductor Soldering and Mounting Techniques Reference Manual, SOLDERRM/D.

ON Semiconductor and are registered trademarks of Semiconductor Components Industries, LLC (SCILLC). SCILLC reserves the right to make changes without further notice to any products herein. SCILLC makes no warranty, representation or guarantee regarding the suitability of its products for any particular purpose, nor does SCILLC assume any liability arising out of the application or use of any product or circuit, and specifically disclaims any and all liability, including without limitation special, consequential or incidental damages. "Typical" parameters which may be provided in SCILLC data sheets and/or specifications can and do vary in different applications and actual performance may vary over time. All operating parameters, including "Typicals" must be validated for each customer application by customer's technical experts. SCILLC does not convey any license under its patent rights nor the rights of others. SCILLC products are not designed, intended, or authorized for use as components in systems intended for surgical implant into the body, or other applications intended to support or sustain life, or for any other application in which the failure of the SCILLC product could create a situation where personal injury or death may occur. Should Buyer purchase or use SCILLC products for any such unintended or unauthorized application, Buyer shall indemnify and hold SCILLC and its officers, employees, subsidiaries, affiliates, and distributors harmless against all claims, costs, damages, and expenses, and reasonable attorney fees arising out of, directly or indirectly, any claim of personal injury or death associated with such unintended or unauthorized use, even if such claim alleges that SCILLC was negligent regarding the design or manufacture of the part. SCILLC is an Equal Opportunity/Affirmative Action Employer. This literature is subject to all applicable copyright laws and is not for resale in any manner.

### PUBLICATION ORDERING INFORMATION

**LITERATURE FULFILLMENT:**  
Literature Distribution Center for ON Semiconductor  
P.O. Box 5163, Denver, Colorado 80217 USA  
**Phone:** 303-675-2175 or 800-344-3860 Toll Free USA/Canada  
**Fax:** 303-675-2176 or 800-344-3867 Toll Free USA/Canada  
**Email:** orderlit@onsemi.com

**N. American Technical Support:** 800-282-9855 Toll Free  
USA/Canada  
**Europe, Middle East and Africa Technical Support:**  
Phone: 421 33 790 2910  
**Japan Customer Focus Center**  
Phone: 81-3-5773-3850

**ON Semiconductor Website:** [www.onsemi.com](http://www.onsemi.com)  
**Order Literature:** <http://www.onsemi.com/orderlit>  
For additional information, please contact your local Sales Representative