

## Multi Stage Performance EMI Filter



- Rated current from 1 to 36 A
- Multi stage filter
- High differential mode performance
- Optional medical version (Type B)
- Optional safety version (Type A)

### Approvals:



### Technical specifications

Maximum continuous operating voltage: 250VAC, 50/60Hz

Operating frequency: dc to 400Hz

Rated currents: 1 to 36A @ 40°C max.

High potential test voltage: L → PE 3000VDC for 2 sec (standard types)

L → PE 3500VDC for 2 sec (B types)

L → N 1100VDC for 2 sec

Temperature range (operation and storage): -25°C to +100°C (25/100/21)

Design corresponding to: UL 1283.

### CIRCUIT DIAGRAM:

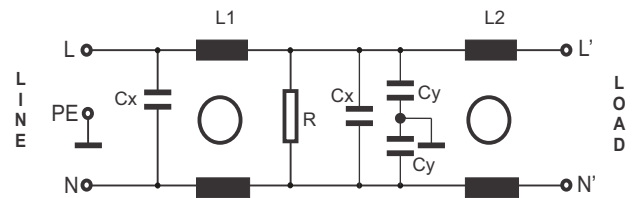

### Feature and Benefits



- BL2070 two-stage filters are designed for easy and fast chassis mounting.
- The BL2070 filters are also available as B versions with no Y-capacitors for medical applications as well as A versions with low capacitance for safety critical applications with a requirement for low leakage currents.
- All filters provide an general purpose conducted attenuation performance, based on chokes with high saturation resistance and excellent thermal behavior.
- The BL 2070 Filter can be use to cover broad range of uses and they can offer a good size/amperages ratio
- BL 2070 filters are also available as single stage filters (BL 2020 series).
- Various terminal options allow you to select the desired connection style

### Typical Application

- Electrical and electronic equipment
- Consumer goods
- Household equipment
- Medical equipment
- Electronic data processing equipment
- Office automation and datacom equipment
- Industrial application
- Machinery
- Various noisy application requires good attenuation performance filter

## 2 EMI FILTER>BL2070

### FILTER SELECTION TABLE

	Rated current @40°C	Leakage current @230V/50Hz	Inductance $\Sigma L$	Capacitance $\Sigma Cx$	Capacitance $\Sigma Cy$	Resistance $\Sigma R$	Connetion type		
	A	mA	mH	$\mu F$	nF	$K_{\Omega}$			
BL2070-01-F	1	0.73	44	0.66	9.4	1000	F	W	
BL2070-03-F	3	0.73	19.6	0.94	9.4	470	F	W	
BL2070-06-F	6	0.73	15.6	2	9.4	220	F	W	
BL2070-10-F	10	0.73	9	2	9.4	220	F	W	
BL2070-12-F	12	0.73	6.5	2	9.4	220	F	W	
BL2070-16-F	16	0.73	3.6	2	9.4	220	F	W	S
BL2070-25-S	25	0.73	4	4.4	9.4	220			S
BL2070-36-S	36	0.86	2.46	4.4	9.4	220			S
BL2070A-01-F	1	0.073	44	0.66	0.94	1000	F	W	
BL2070A-03-F	3	0.073	19.6	0.94	0.94	470	F	W	
BL2070A-06-F	6	0.073	15.6	2	0.94	220	F	W	
BL2070A-10-F	10	0.073	9	2	0.94	220	F	W	
BL2070A-12-F	12	0.073	6.5	2	0.94	220	F	W	
BL2070A-16-F	16	0.073	3.6	2	0.94	220	F	W	S
BL2070A-25-S	25	0.073	4	4.4	0.94	220			S
BL2070A-36-S	36	0.073	2.46	4.4	0.94	220			S
BL2070B-01-F	1	0.002	44	0.66		1000	F	W	
BL2070B-03-F	3	0.002	19.6	0.94		470	F	W	
BL2070B-06-F	6	0.002	15.6	2		220	F	W	
BL2070B-10-F	10	0.002	9	2		220	F	W	
BL2070B-12-F	12	0.002	6.5	2		220	F	W	
BL2070B-16-F	16	0.002	3.6	2		220	F	W	S
BL2070B-25-S	25	0.002	4	4.4		220			S
BL2070B-36-S	36	0.002	4.4	4.4		220			S

Insertion Loss: Common mode - —  
Differential mode- —

1 to 3 A

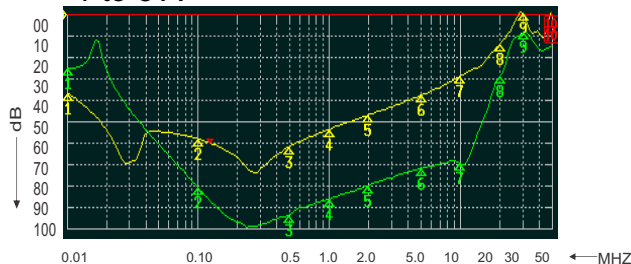

6A & 10A

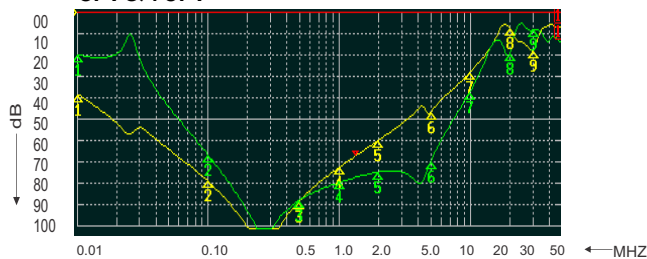

12 to 16 A

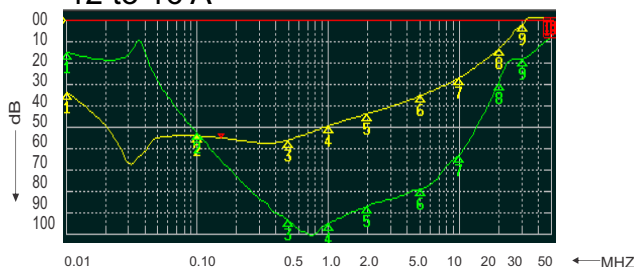

25A to 36 A

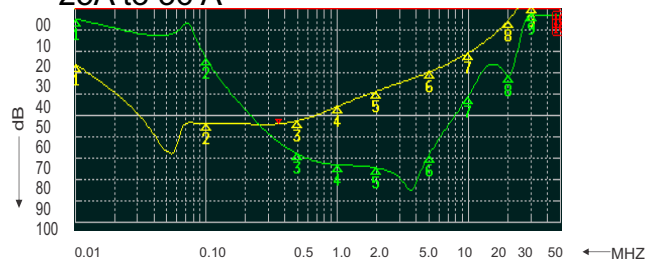

**MECHANICAL DIMENSION (mm):**

CONNECTION TYPE -F  
1A

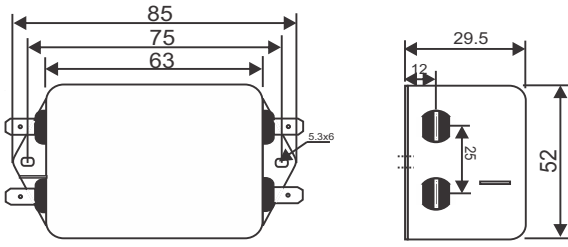

CONNECTION TYPE -F  
3A

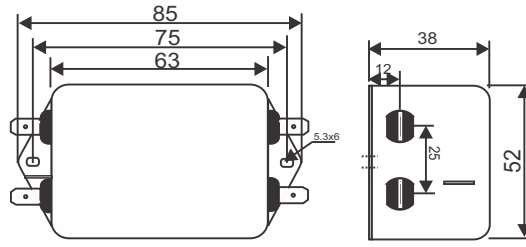

CONNECTION TYPE -F  
6A

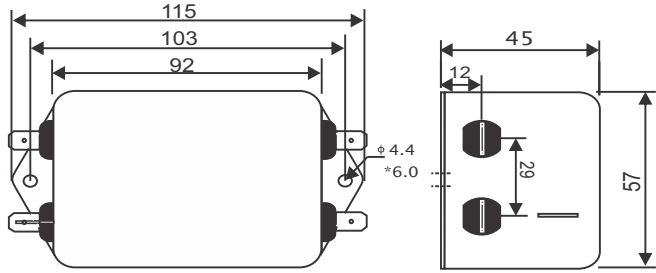

CONNECTION TYPE -F  
10A & 12A

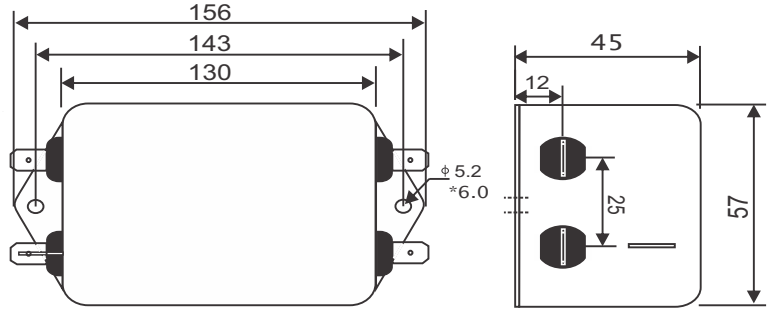

CONNECTION TYPE -F  
16A

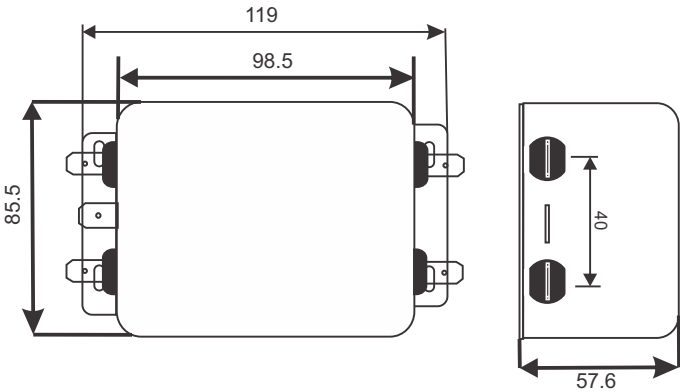

CONNECTION TYPE -S  
25A

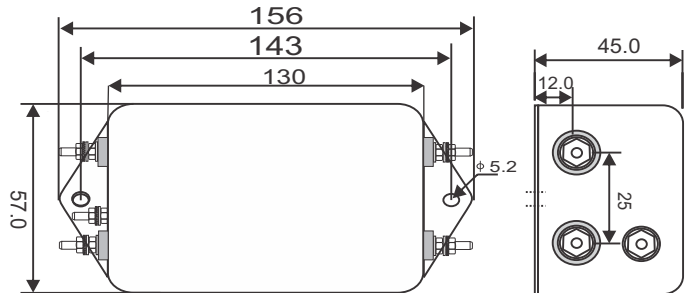

CONNECTION TYPE -S  
16A & 36A

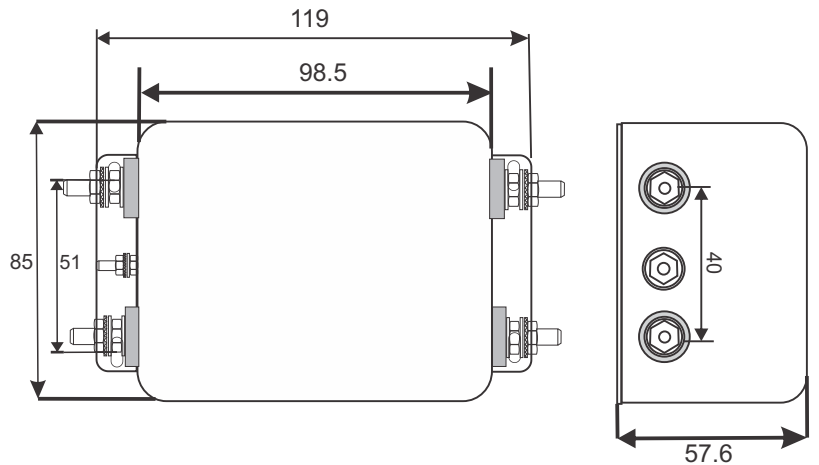

**NOTE:**

All Dimension in mm  
Connection type F-Fast On Terminal(6.3x0.8)  
S-Screw (M4 & M5)