

Features

- RoHS compliant*
- SMA package
- Surface mount
- High current capability



The Model CD214A-B3xR Series is the recommended replacement.

CD214A-B320 ~ B360 Schottky Barrier Rectifier Chip Diode

General Information

The markets of portable communications, computing and video equipment are challenging the semiconductor industry to develop increasingly smaller electronic components.

Bourns offers Schottky Rectifier Diodes for rectification applications, in compact chip package DO-214AC (SMA) size format, which offer PCB real estate savings and are considerably smaller than competitive parts. The Schottky Rectifier Diodes offer a forward current of 3 A with a choice of repetitive peak reverse voltage of 20 V up to 60 V.

Bourns® Chip Diodes conform to JEDEC standards, are easy to handle on standard pick and place equipment and their flat configuration minimizes roll away.

Electrical Characteristics (@ T_A = 25 °C Unless Otherwise Noted)

Parameter	Symbol	CD214A-						Unit
		B320	B330	B340	B340L	B350	B360	
Forward Voltage (Max.) (I _f = 3 A)	V _F	0.5	0.5	0.5	0.45	0.7	0.7	V
Typical Junction Capacitance**	C _T	250	250	250	300	250	250	pF
Reverse Current (Max.) at Rated V _R)	I _R	0.5	0.5	0.5	1.0	0.5	0.5	mA

** Measured at 1.0 MHz and applied reverse voltage of 4.0 VDC.

Absolute Ratings (@ T_A = 25 °C Unless Otherwise Noted)

Parameter	Symbol	CD214A-						Unit
		B320	B330	B340	B340L	B350	B360	
Repetitive Peak Reverse Voltage	V _{RRM}	20	30	40	40	50	60	V
Reverse Voltage	V _R	20	30	40	40	50	60	V
Maximum RMS Voltage	V _{RMS}	14	21	28	28	35	42	V
Avg. Forward Current	I _O	3						A
Forward Current, Surge Peak (60 Hz, 1 cycle)	I _{surge}	100	100	100	70	100	100	A
Typical Thermal Resistance***	R _{θJL}	10	10	10	20	10	10	°C/W
Storage Temperature	T _{STG}	-55 to +150						°C
Junction Temperature	T _J	-55 to +125						°C

*** Thermal resistance junction to lead.

BOURNS®

Asia-Pacific: Tel: +886-2 2562-4117 • Email: asiacus@bourns.com

EMEA: Tel: +36 88 520 390 • Email: eurocus@bourns.com

The Americas: Tel: +1-951 781-5500 • Email: americus@bourns.com

www.bourns.com

How to Order

Common Code	CD 214A - B 3 40 L LF
Chip Diode	
Package	214A = SMA/DO-214AC
Model	B = Schottky Barrier Series
Average Forward Current (I _O) Code	3 = 3 A (Code x 1000 mA = Average Forward Current)
Reverse Voltage (V _R) Code	30 = 30 V 40 = 40 V 60 = 60 V
Forward Voltage Suffix (Applies to -B340L only)	L = Low Forward Voltage V _f (-B340L only) No Space in P/N = Not Low Forward Voltage
Terminations	LF = 100 % Sn (RoHS Compliant*)

*RoHS Directive 2002/95/EC Jan. 27, 2003 including annex and RoHS Recast 2011/65/EU June 8, 2011.

Specifications are subject to change without notice.

The device characteristics and parameters in this data sheet can and do vary in different applications and actual device performance may vary over time.

Users should verify actual device performance in their specific applications.

CD214A-B320 ~ B360 Schottky Barrier Rectifier Chip Diode

BOURNS®

Rating and Characteristic Curves: CD214A-B320, CD214A-B330, CD214A-B340, CD214A-B350 & CD214A-B360

Forward Characteristics

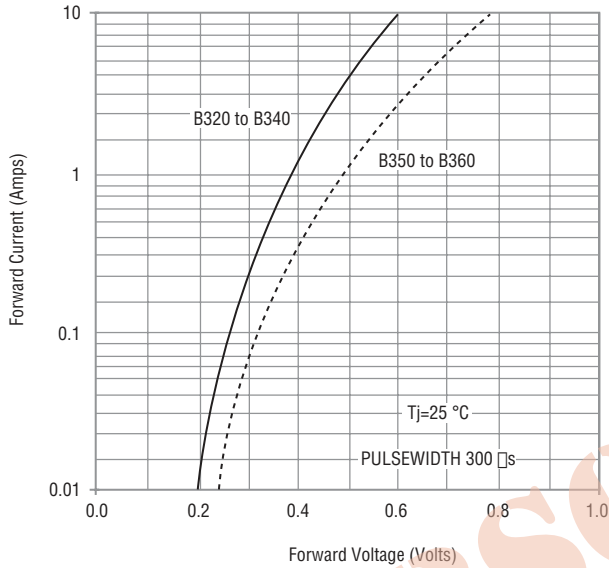

Reverse Characteristics

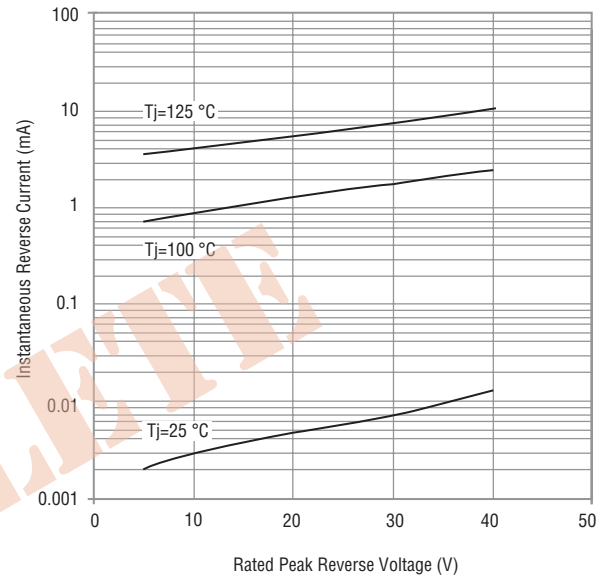

Derating Curve

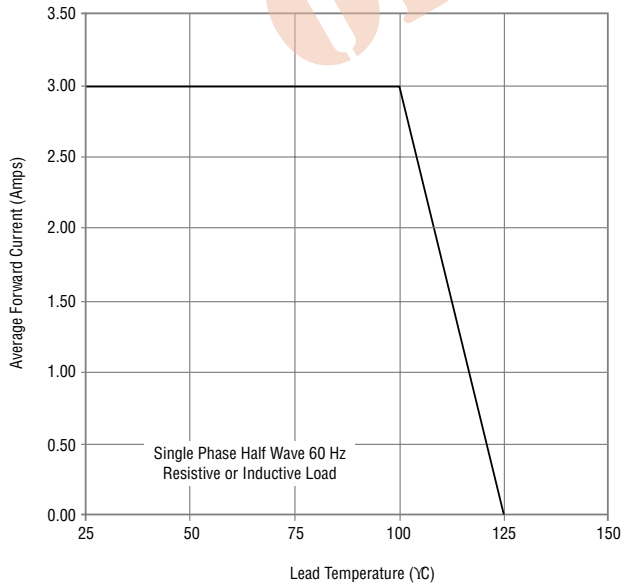

Capacitance Between Terminals

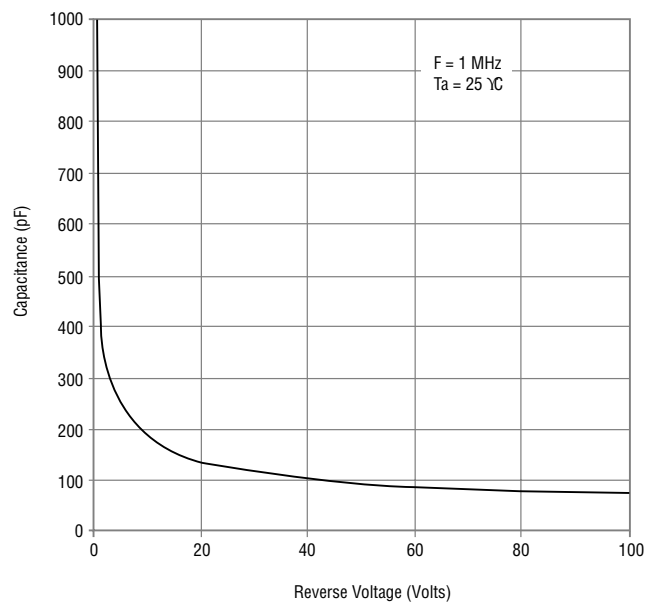

Specifications are subject to change without notice.

The device characteristics and parameters in this data sheet can and do vary in different applications and actual device performance may vary over time. Users should verify actual device performance in their specific applications.

CD214A-B320 ~ B360 Schottky Barrier Rectifier Chip Diode



Rating and Characteristic Curves: CD214A-B340L

Forward Characteristics

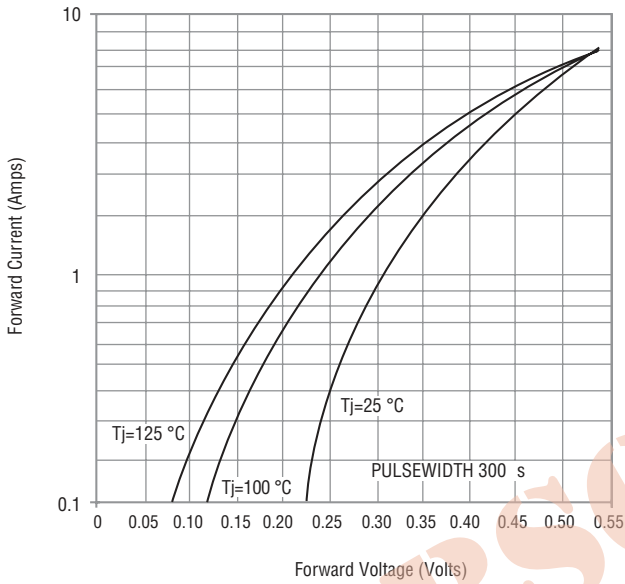

Reverse Characteristics

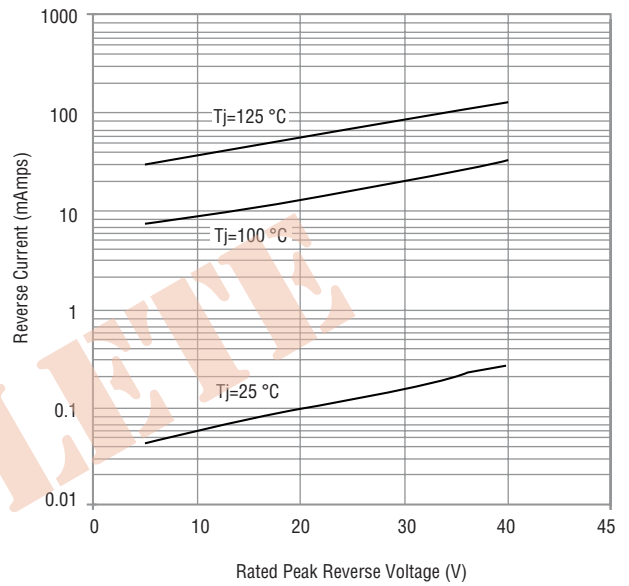

Derating Curve

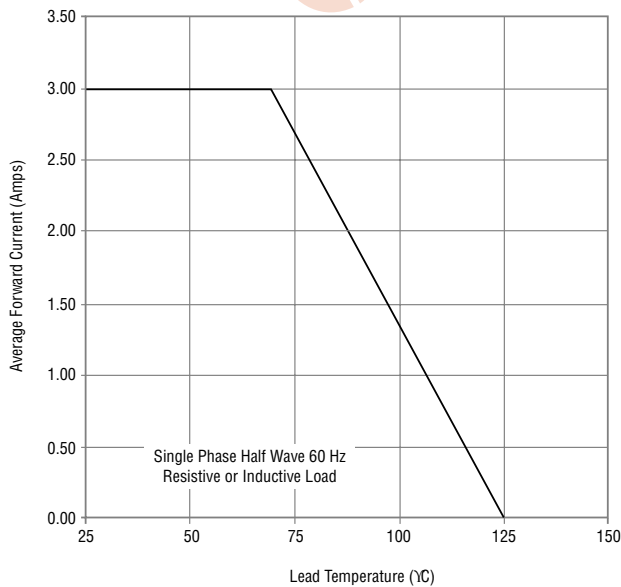

Capacitance Between Terminals

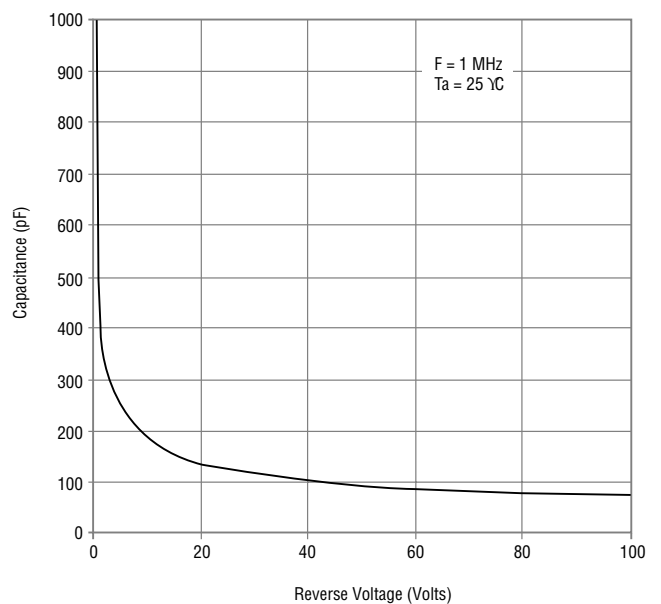

CD214A-B320 ~ B360 Schottky Barrier Rectifier Chip Diode



Product Dimensions

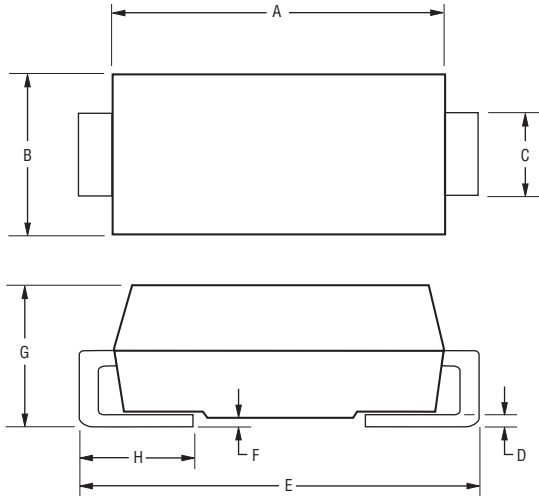

Dimension	SMA (DO-214AC)
A	$\frac{4.06 - 4.57}{(0.160 - 0.180)}$
B	$\frac{2.29 - 2.92}{(0.090 - 0.115)}$
C	$\frac{1.27 - 1.63}{(0.050 - 0.064)}$
D	$\frac{0.15 - 0.31}{(0.006 - 0.110)}$
E	$\frac{4.83 - 5.59}{(0.190 - 0.220)}$
F	$\frac{0.05 - 0.20}{(0.002 - 0.008)}$
G	$\frac{2.01 - 2.62}{(0.080 - 0.103)}$
H	$\frac{0.76 - 1.52}{(0.030 - 0.060)}$

DIMENSIONS: $\frac{\text{MM}}{\text{(INCHES)}}$

Recommended Pad Layout

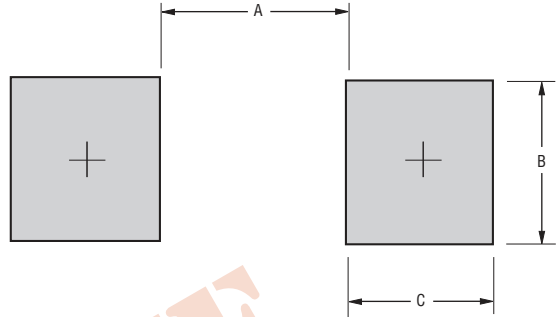

Dimension	SMA (DO-214AC)
A	$\frac{2.90}{(0.114)}$
B	$\frac{2.40}{(0.094)}$
C	$\frac{2.30}{(0.091)}$

DIMENSIONS: $\frac{\text{MM}}{\text{(INCHES)}}$

Physical Specifications

Case Molded plastic
 Polarity..... Indicated by cathode band
 Weight 0.002 ounces / 0.064 grams

Typical Part Marking

CD214A-B320 **B** 320A
 CD214A-B330 **B** 330A
 CD214A-B340 **B** 340A
 CD214A-B340L **B** 340LA
 CD214A-B350 **B** 350A
 CD214A-B360 **B** 360A

CD214A-B320 ~ B360 Schottky Barrier Rectifier Chip Diode

BOURNS®

Packaging Information

The product is dispensed in tape and reel format (see diagram below).

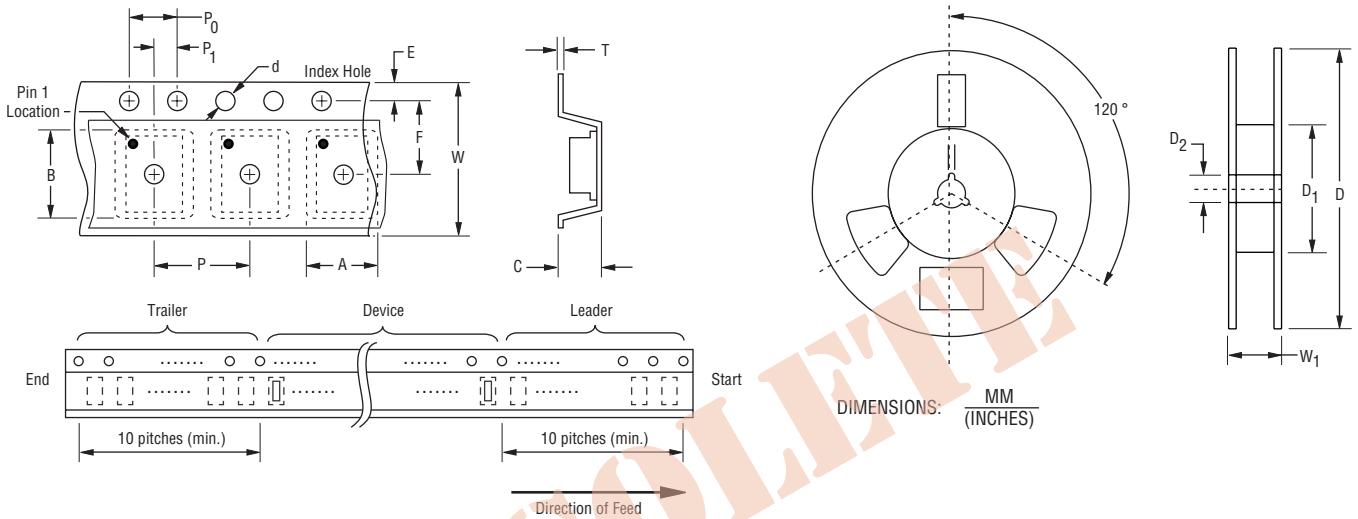

Item	Symbol	SMA (DO-214AC)
Carrier Width	A	$\frac{2.90 \pm 0.10}{(0.114 \pm 0.004)}$
Carrier Length	B	$\frac{5.59 \pm 0.10}{(0.220 \pm 0.004)}$
Carrier Depth	C	$\frac{2.36 \pm 0.10}{(0.093 \pm 0.004)}$
Sprocket Hole	d	$\frac{1.55 \pm 0.05}{(0.061 \pm 0.002)}$
Reel Outside Diameter	D	$\frac{3.30}{(12.992)}$
Reel Inner Diameter	D ₁	$\frac{50.0}{(1.969)}$ MIN.
Feed Hole Diameter	D ₂	$\frac{13.0 \pm 0.20}{(0.512 \pm 0.008)}$
Sprocket Hole Position	E	$\frac{1.75 \pm 0.10}{(0.069 \pm 0.004)}$
Punch Hole Position	F	$\frac{5.50 \pm 0.05}{(0.217 \pm 0.002)}$
Punch Hole Pitch	P	$\frac{4.00 \pm 0.10}{(0.157 \pm 0.004)}$
Sprocket Hole Pitch	P ₀	$\frac{4.00 \pm 0.10}{(0.157 \pm 0.004)}$
Embossment Center	P ₁	$\frac{2.00 \pm 0.05}{(0.079 \pm 0.002)}$
Overall Tape Thickness	T	$\frac{0.30 \pm 0.10}{(0.012 \pm 0.004)}$
Tape Width	W	$\frac{12.00 \pm 0.20}{(0.472 \pm 0.008)}$
Reel Width	W ₁	$\frac{18.4}{(0.724)}$ MAX.
Quantity per Reel	--	5,000

Devices are packed in accordance with EIA standard RS-481-A and specifications shown here.

REV. 01/18

Specifications are subject to change without notice. The device characteristics and parameters in this data sheet can and do vary in different applications and actual device performance may vary over time. Users should verify actual device performance in their specific applications.