

LTC4249 65V Dual Electronic Circuit Breaker with Current Monitors

DESCRIPTION

The DC2733 is a demonstration system for the [LTC®4249](#), 65V Dual Electronic Circuit Breaker with Current Monitors. The LTC4249 provides dual independent 1.2A, 75mΩ circuit breakers that can function independently or work together in parallel. Each circuit breaker channel has its own enable, ready, and IMON pins.

The DC2733 demo board gives access to both channels of the LTC4249, including the independent RDY and IMON outputs and the EN inputs. Resistors at the IMON pins set the circuit breaker thresholds as well as the IMON current-to-voltage gains. The IC draws power from the IN1 input.

DC2733 Board Features

- Demonstrate dual LTC4249 circuit breaker channels
- Monitor each channel current with IMON
- Gang multiple parallel channels for larger currents
- Convenient on-board pushbutton enable control

DC2733 Hardware Required

- DC2733 board
- Input power supply between 6V and 65V
- Two 1.2A loads

[Design files for this circuit board are available.](#)

All registered trademarks and trademarks are the property of their respective owners.

BOARD PHOTO

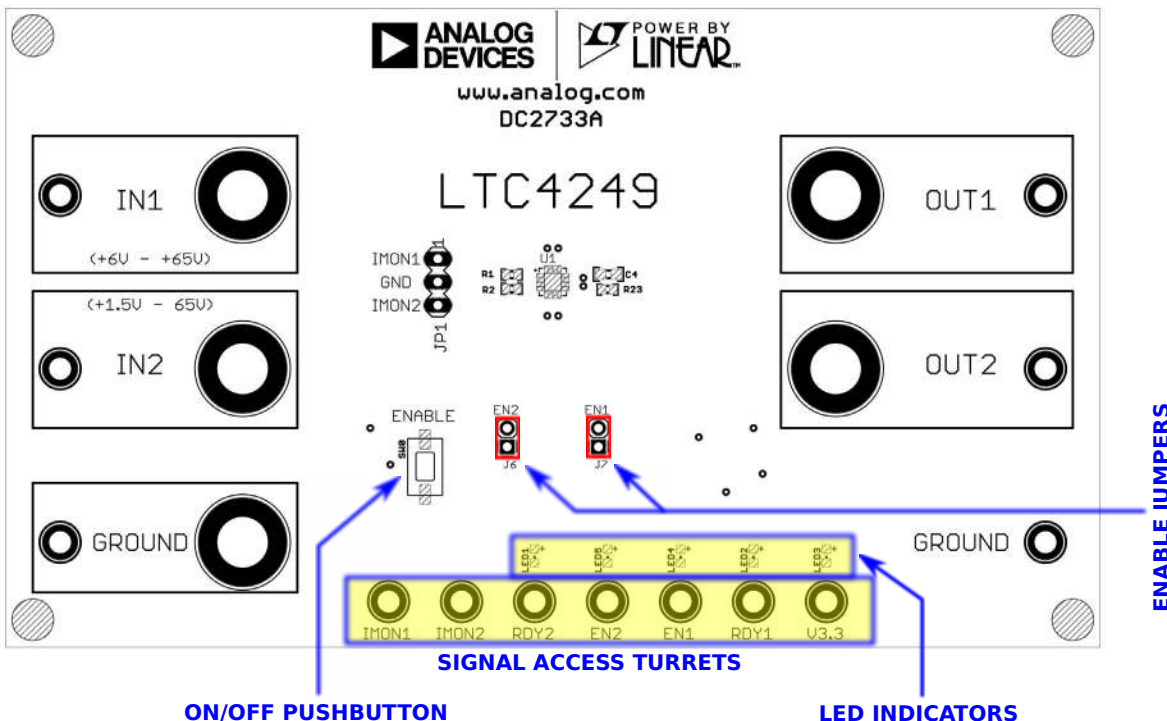

DEMO MANUAL DC2733A

PERFORMANCE SUMMARY Specifications are at $T_A = 25^\circ\text{C}$

PARAMETER	CONDITIONS	MIN	TYP	MAX	UNITS
IN1 and OUT1 Operating Voltage Range	Referenced to GROUND	6		65	V
IN2 and OUT2 Operating Voltage Range ⁽¹⁾	Referenced to GROUND	1.5		65	V
(IN n - OUT n)	Channel off. Reverse voltage not permitted.	0		65	V
IN n Forward Current	Forward current flows from IN n to OUT n	0		1.2	A
IN n Reverse Current ⁽²⁾	Reverse current flows from OUT n to IN n	-1.2		0	A
CH n Switch Resistance while On	Channel enabled		75	150	m Ω
CH n Switch Resistance while Off		300			k Ω
Circuit Breaker Response Time (1x OC)	$V_{IMON} > 1.2V$			60	μs
IMON Output Current Accuracy ⁽³⁾	$I_{OUT} = 1.0A$	-3		3	%
Circuit Breaker Threshold Accuracy	1x threshold	-2.5		2.5	%

(1) IN2 may be tied to GND if unused.

(2) Reverse current is only permitted when the channel is on. An internal diode from OUT n to IN n will forward bias if OUT n voltage is above IN n .

(3) IMON does not register reverse current. The circuit breaker will not respond to reverse current.

QUICK START PROCEDURE

The LTC4249 is a positive voltage circuit breaker. It has two independent 75mΩ switches that turn on when their associated EN n pin is high, and turn off either when EN n is lowered or when the forward current causes the voltage at the IMON pin to exceed 1.2V. On the DC2733 demo board, each hardware channel is independent, with an input port, IN n , and an output port, OUT n . Current flowing from IN to OUT is positive. Voltage at both the input and output pins must remain between 0V and 65V with respect to GROUND. Each channel's input-to-output voltage must remain positive: (V_{IN} – V_{OUT}) > 0.0V. A reverse biased channel will conduct reverse current, even when the circuit breaker is off, due to an internal diode across the circuit breaker switch. Both circuit breaker channels may be shorted together and used in parallel to increase current carrying capacity.

An enabled circuit breaker output indicates ready with the RDY n pin. Each circuit breaker channel operates independently. Reset a circuit breaker channel by lowering and raising its EN n input.

Please read the LTC4249 data sheet for more information.

On the DC2733A board there are two configuration jumpers that connect the EN n inputs of the IC to the pushbutton ON/OFF switch. The default jumper settings are suitable for both channels activated together by the pushbutton. The pushbutton uses an LTC2954 pushbutton controller that is powered by an on-board auxiliary 3.3V power domain. The 3.3V power rail is produced from IN1 by an LT3010 linear regulator. Refer to the board schematics for details.

Table 1. Jumper Summary

JUMPER	SETTING	COMMENT
EN1 (J7)	Connected (DEFAULT)	The LTC4249 EN1 input is connected to the pushbutton ON/OFF switch.
	Removed	The LTC4249 EN1 input is floating and may be driven externally. **
EN2 (J6)	Connected (DEFAULT)	The LTC4249 EN2 input is connected to the pushbutton ON/OFF switch.
	Removed	The LTC4249 EN2 input is floating and may be driven externally. **
ENABLE (SWO)	Pushbutton toggle	Enable/disable the EN n pins.

** LTC4249 EN n inputs have internal pull-up currents to INTV_{CC}.

The LEDs on the board indicate the state of the EN n pins, the RDY n pins, and the 3.3V auxiliary power rail.

LED	Function
EN1 (LED4)	Illuminates green when the EN1 pin of the LTC4249 is high (active).
EN2 (LED5)	Illuminates green when the EN2 pin of the LTC4249 is high (active).
RDY1 (LED2)	Illuminates green when the RDY1 pin of the LTC4249 is high (active).
RDY2 (LED1)	Illuminates green when the RDY2 pin of the LTC4249 is high (active).
V3.3 (LED3)	Illuminates green when the V3.3 power rail is active (powered by IN1).

QUICK START PROCEDURE

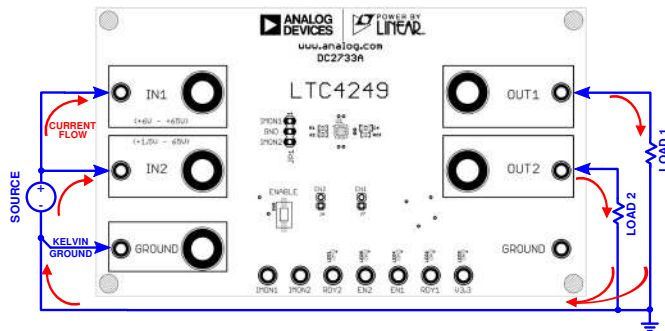

Figure 1. Source and Load Connections. Current Return Outside of Board.

Connect input power supplies to IN1 and IN2 inputs, and connect independent loads to OUT1 and OUT2 ports, as in Figure 1. The same input supply may connect to both IN1 and IN2. The LTC4249 draws power from the IN1 port, so powering IN1 is a minimal requirement. Driving IN2 is optional. If channel 2 is unused tie IN2 to GND. OUT2 may be left floating.

The board has several connections labeled GROUND. When connecting power supplies and loads, the currents naturally flow from IN n pins, through the LTC4249, then out through the OUT n pins. On the current return path, however, it is best to avoid ground currents flowing through the GROUND plane of the demo board. Instead, connect a single wire from ground near the power supplies to one of the GROUND connections on the board, forming a Kelvin connection back to the system ground point. This avoids load currents flowing through the GROUND plane on the board. See Figure 1.

In the configuration of Figure 1 when the forward current through CH1 exceeds the programmed circuit breaker threshold the channel will turn off. The current through CH2 will be unaffected. Re-enable a channel by toggling EN n .

It is also possible to use channels in parallel, as shown in Figure 2. Channels will share current, but remember that channel impedances are not perfectly matched, so currents will share slightly unevenly. When the circuit breaker trips it will trip in one channel first, followed quickly by the other channel, usually within about 20 μ s.

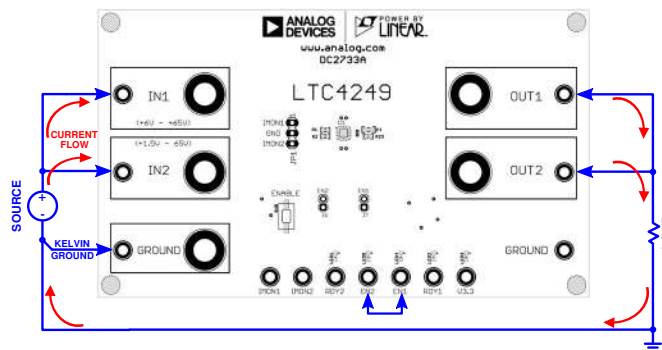

Figure 2. Parallel Channel Operation

A transient fault will trip the circuit breaker then allow the LTC4249 to restart after the retry interval. A fault lasting longer than 3 seconds (3 retries) will result in a persistent off condition. Clear a faulted channel by toggling EN n low then high.

The demo board has 10k Ω resistors at both of the IMON pins. This is the recommended value to give a circuit breaker current threshold of 1.2A (1.2V on IMON). While 10k Ω is the smallest recommended resistor value, it is possible to replace R1 and R2 on the board with larger valued resistors to lower the circuit breaker current threshold. The relationship between resistance and CB threshold is:

$$I_{CB} = \frac{1.2 \cdot 10k}{R_{IMON}} \quad (1)$$

Note that circuit breaker accuracy is directly related to the accuracy of R1 and R2. We use 0.1% resistor tolerance for best results.

In addition to controlling the circuit breaker, the IMON pins can be used by an external circuit to read channel current.

QUICK START PROCEDURE

The IMON pin voltage represents the current flowing in its channel. Attach a voltage meter or ADC to each IMON pin as shown in Figure 3.

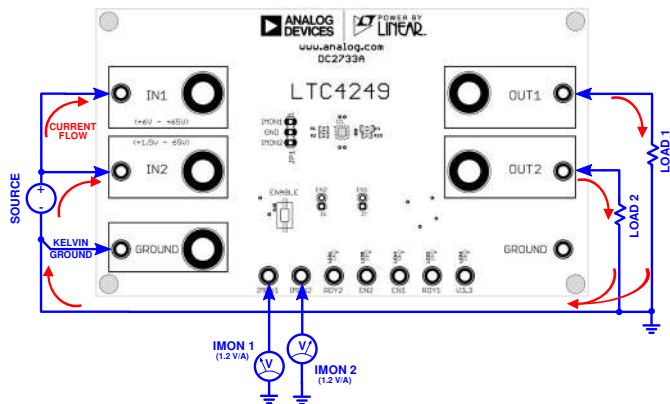

Figure 3. IMON Current Monitoring

Each LTC4249 channel switch has a body diode that will conduct in the OUT-to-IN direction if voltage is reversed. For this reason $V(OUT)$ must always be less than or equal to $V(IN)$. To prevent potential backward flowing current

use two switches in series, back-to-back, as shown in Figure 4. In this case the return current necessarily flows externally to the board, but the Kelvin GND connection is still required.

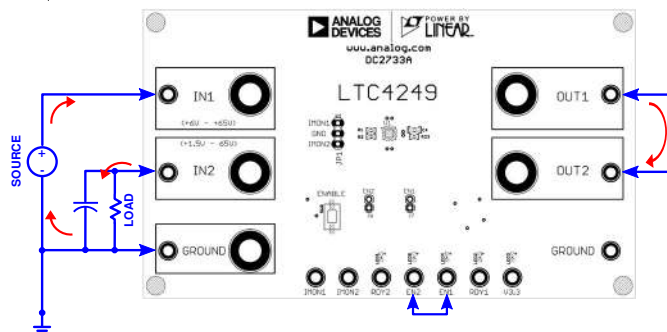
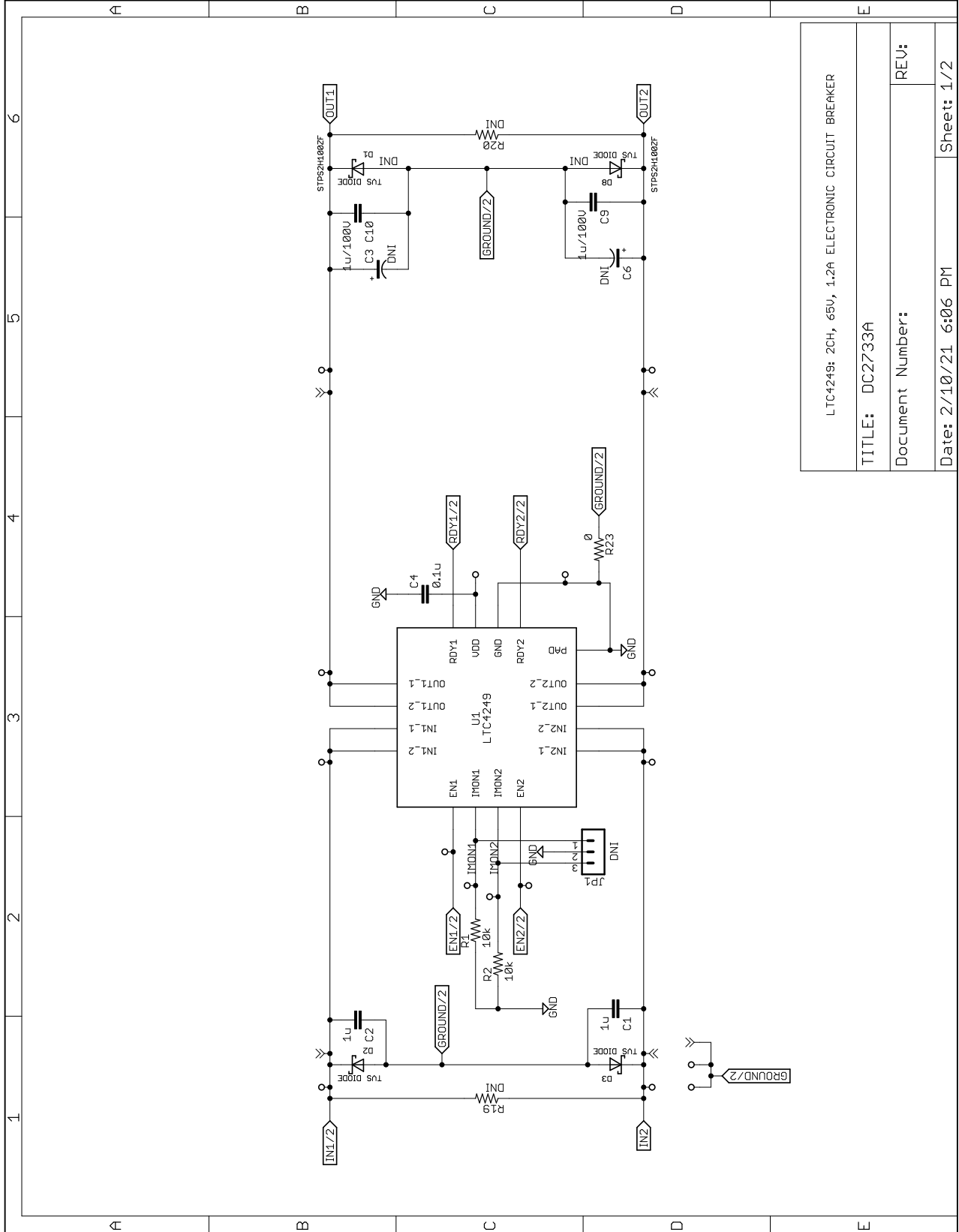

Figure 4. Series Switches to Eliminate Potential Reverse Current

DEMO MANUAL DC2733A

SCHEMATIC DIAGRAM



LTC4249: 2CH, 65V, 1.2A ELECTRONIC CIRCUIT BREAKER	
TITLE: DC2733A	
Document Number:	REV:
Date: 2/10/21 6:06 PM	Sheet: 1/2

SCHEMATIC DIAGRAM

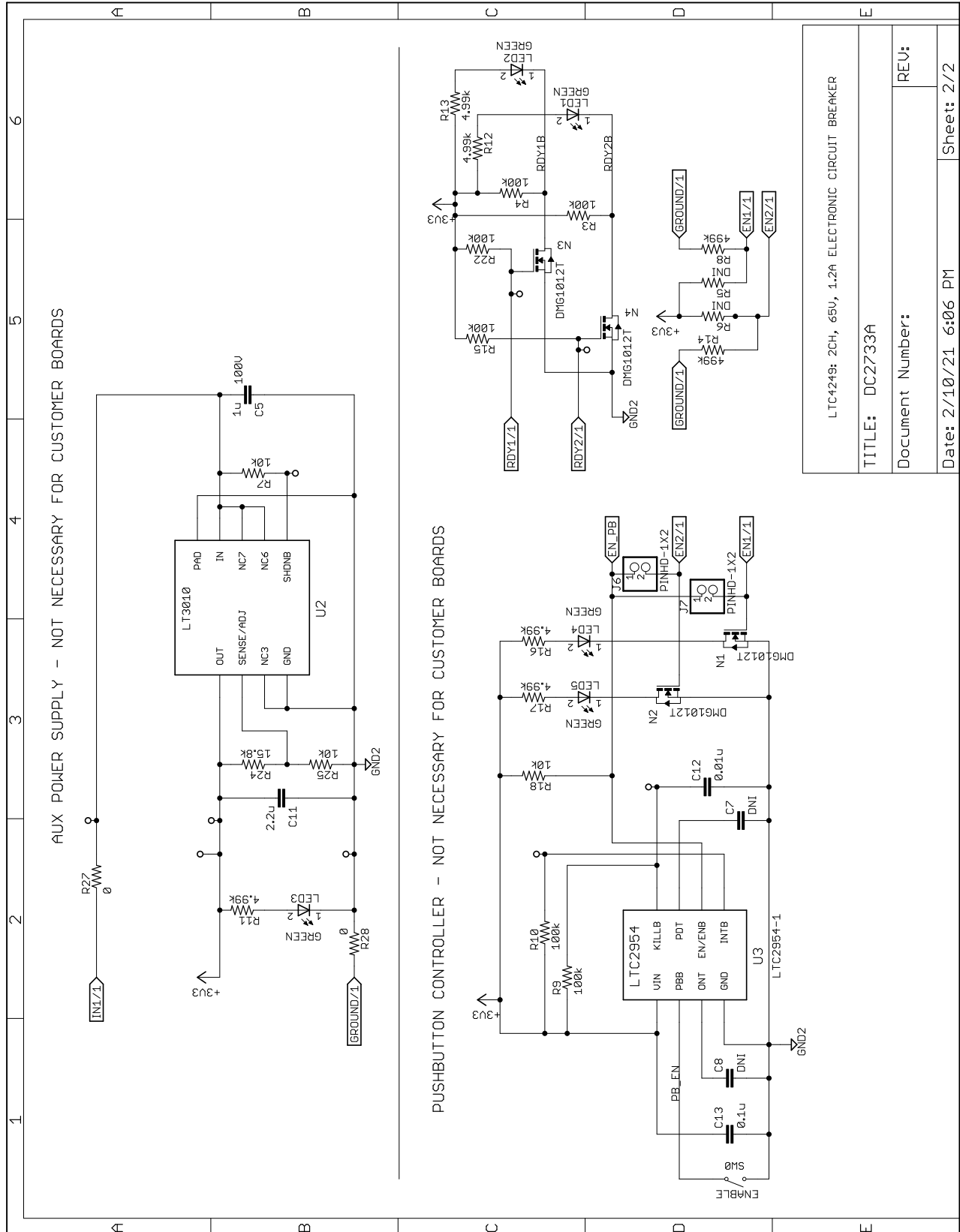



ESD Caution

ESD (electrostatic discharge) sensitive device. Charged devices and circuit boards can discharge without detection. Although this product features patented or proprietary protection circuitry, damage may occur on devices subjected to high energy ESD. Therefore, proper ESD precautions should be taken to avoid performance degradation or loss of functionality.

Legal Terms and Conditions

By using the evaluation board discussed herein (together with any tools, components documentation or support materials, the "Evaluation Board"), you are agreeing to be bound by the terms and conditions set forth below ("Agreement") unless you have purchased the Evaluation Board, in which case the Analog Devices Standard Terms and Conditions of Sale shall govern. Do not use the Evaluation Board until you have read and agreed to the Agreement. Your use of the Evaluation Board shall signify your acceptance of the Agreement. This Agreement is made by and between you ("Customer") and Analog Devices, Inc. ("ADI"), with its principal place of business at One Technology Way, Norwood, MA 02062, USA. Subject to the terms and conditions of the Agreement, ADI hereby grants to Customer a free, limited, personal, temporary, non-exclusive, non-sublicensable, non-transferable license to use the Evaluation Board FOR EVALUATION PURPOSES ONLY. Customer understands and agrees that the Evaluation Board is provided for the sole and exclusive purpose referenced above, and agrees not to use the Evaluation Board for any other purpose. Furthermore, the license granted is expressly made subject to the following additional limitations: Customer shall not (i) rent, lease, display, sell, transfer, assign, sublicense, or distribute the Evaluation Board; and (ii) permit any Third Party to access the Evaluation Board. As used herein, the term "Third Party" includes any entity other than ADI, Customer, their employees, affiliates and in-house consultants. The Evaluation Board is NOT sold to Customer; all rights not expressly granted herein, including ownership of the Evaluation Board, are reserved by ADI. CONFIDENTIALITY. This Agreement and the Evaluation Board shall all be considered the confidential and proprietary information of ADI. Customer may not disclose or transfer any portion of the Evaluation Board to any other party for any reason. Upon discontinuation of use of the Evaluation Board or termination of this Agreement, Customer agrees to promptly return the Evaluation Board to ADI. ADDITIONAL RESTRICTIONS. Customer may not disassemble, decompile or reverse engineer chips on the Evaluation Board. Customer shall inform ADI of any occurred damages or any modifications or alterations it makes to the Evaluation Board, including but not limited to soldering or any other activity that affects the material content of the Evaluation Board. Modifications to the Evaluation Board must comply with applicable law, including but not limited to the RoHS Directive. TERMINATION. ADI may terminate this Agreement at any time upon giving written notice to Customer. Customer agrees to return to ADI the Evaluation Board at that time. LIMITATION OF LIABILITY. THE EVALUATION BOARD PROVIDED HEREUNDER IS PROVIDED "AS IS" AND ADI MAKES NO WARRANTIES OR REPRESENTATIONS OF ANY KIND WITH RESPECT TO IT. ADI SPECIFICALLY DISCLAIMS ANY REPRESENTATIONS, ENDORSEMENTS, GUARANTEES, OR WARRANTIES, EXPRESS OR IMPLIED, RELATED TO THE EVALUATION BOARD INCLUDING, BUT NOT LIMITED TO, THE IMPLIED WARRANTY OF MERCHANTABILITY, TITLE, FITNESS FOR A PARTICULAR PURPOSE OR NON-INFRINGEMENT OF INTELLECTUAL PROPERTY RIGHTS. IN NO EVENT WILL ADI AND ITS LICENSORS BE LIABLE FOR ANY INCIDENTAL, SPECIAL, INDIRECT, OR CONSEQUENTIAL DAMAGES RESULTING FROM CUSTOMER'S POSSESSION OR USE OF THE EVALUATION BOARD, INCLUDING BUT NOT LIMITED TO LOST PROFITS, DELAY COSTS, LABOR COSTS OR LOSS OF GOODWILL. ADI'S TOTAL LIABILITY FROM ANY AND ALL CAUSES SHALL BE LIMITED TO THE AMOUNT OF ONE HUNDRED US DOLLARS (\$100.00). EXPORT. Customer agrees that it will not directly or indirectly export the Evaluation Board to another country, and that it will comply with all applicable United States federal laws and regulations relating to exports. GOVERNING LAW. This Agreement shall be governed by and construed in accordance with the substantive laws of the Commonwealth of Massachusetts (excluding conflict of law rules). Any legal action regarding this Agreement will be heard in the state or federal courts having jurisdiction in Suffolk County, Massachusetts, and Customer hereby submits to the personal jurisdiction and venue of such courts. The United Nations Convention on Contracts for the International Sale of Goods shall not apply to this Agreement and is expressly disclaimed.