

# IMP-1550-20-PM

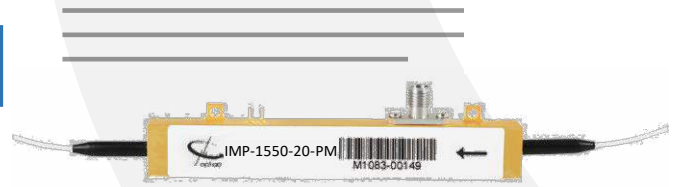

## DEVICE

## 1550 nm, 20 GHz Intensity Modulator w/PM Output

The Optilab IMP-1550-20-PM is a 20 GHz Intensity Modulator that is manufactured with Annealed Proton Exchange(APE) process, it features a zero-chirp design and Polarization Maintaining(PM) fiber output. IMP-1550-20-PM features 20GHz E/O bandwidth, a highly linear transfer function and excellent extinction ratio. Applications include digital transmission up to 20 Gb/s, analog RFoF transmission to 18 GHz, optical pulse generation, mode-locked fiber laser and microwave optical link. The IMP-1550-20-PM is compatible with a wide variety of modulator drivers, and a separate bias port allows the modulator to operate at specific points of the transfer function. The IMP-1550-20-PM Modulator is designed for external modulation of 1550 nm laser up to 18 GHz or 20 Gb/s. It is also applicable for pulse generation for Master Oscillator Power Amplifier(MOPA) configuration. Due to proprietary APE technology, IMP-1550-20-PM can handle input power beyond 100mW and is a bias-stabilized modulator. It has a wide operating temperature tolerance ranging from -25°C to +70°C. Contact Optilab for more information.

## OVERVIEW

## FEATURES

- PM fiber output
- High input power
- Zero chirp design
- Internal PD option
- 1525-1605nm operating wavelength
- High Extinction Ratio (HER) Available
- Temperature range of -25°C to 70°C

## USE IN

- RF over fiber
- Pulse generation
- MOPA
- Analog modulation up to 18 GHz
- Active mode locked laser
- Satellite Link

## FUNCTIONAL DIAGRAM

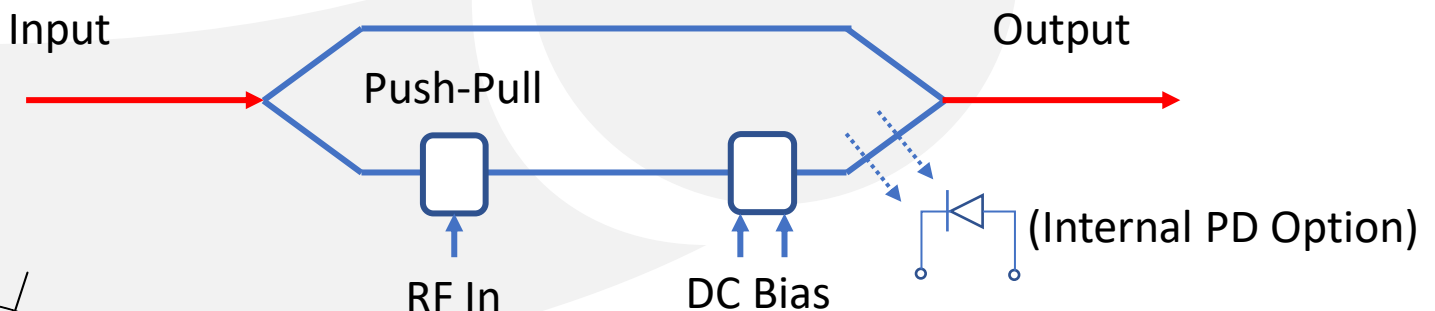

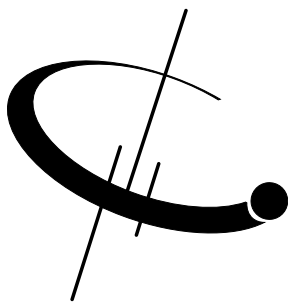

# IMP-1550-20-PM

## SPECIFICATIONS

Maximum Input Power	100 mW
Operating Wavelength	1525 nm to 1605 nm
Chirp Value	± 0.1 max.
Insertion Loss	4.5 dB typ., 5.0 dB max.
Extinction Ratio	> 25 dB., > 30 dB (HER version)
Optical Return Loss	< -45 dB
S21 3 dB Bandwidth	14 GHz typ.
S11 Return Loss	< -10 dB min up to 20 GHz
V $\pi$ (RF Port)	< 5 V @ Low Freq.
RF Input Power	27 dBm
Impedance (RF Port)	50 $\Omega$ typ.
V $\pi$ (DC Port)	< 6 V @ DC
Impedance (Bias Port)	1 M $\Omega$ min.
Internal PD Responsivity	> 10 mA/W

## GENERAL

Operating Temperature	-25 °C to +70 °C (standard)
Storage Temperature	-45 °C to +85 °C
Operating Humidity	0% to 90% Relative Humidity
Input/Output Fiber Type	PANDA - PM 400um buffer
Input Connector	PM FC/APC
Output Connector	PM FC/APC
Crystal Orientation	X-cut, y-propagating
Waveguide Process	Annealed Proton Exchange (APE)
Bias Port Connector	2 Pins/4Pins Optional
RF Port Connectors	Anritsu K female
Cabling	900 um loose tubing
Dimensions	66 mm x 22 mm x 9 mm

## MECHANICAL



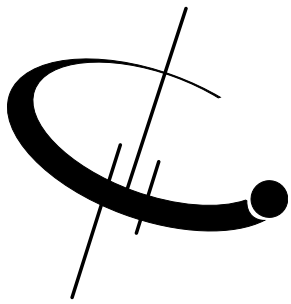

# IMP-1550-20-PM

## SAMPLE S21 AND S11 BANDWIDTH

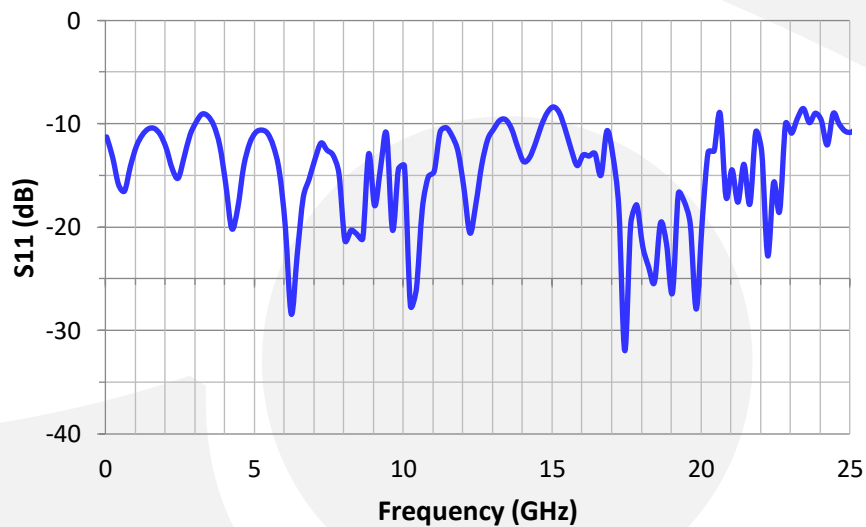
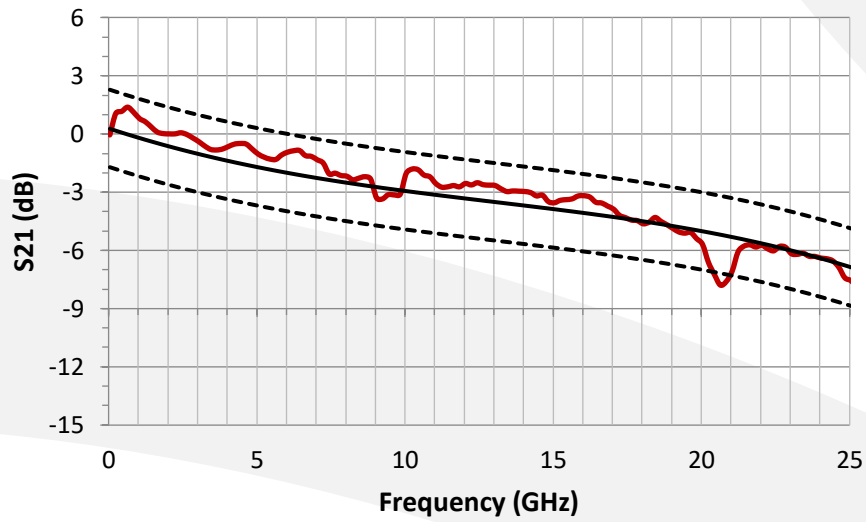

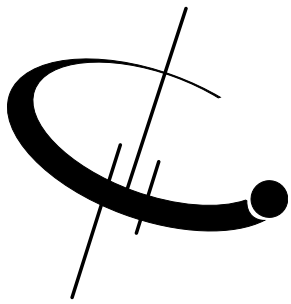

# IMP-1550-20-PM

## MECHANICAL DRAWING

### 1. IMP-1550-20-PM-PD Housing, W/Internal PD

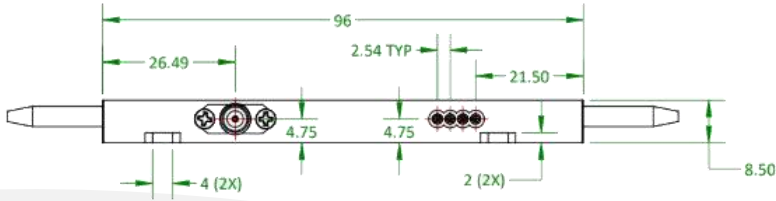
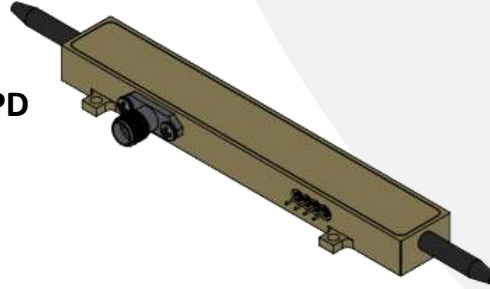

FRONT VIEW

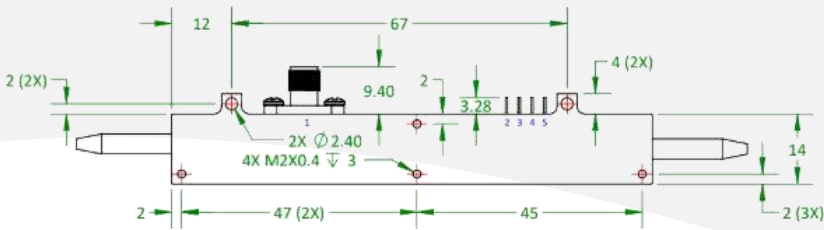

BOTTOM VIEW

PIN #	Symbol
1	RF
2	GND
3	B
4	PD-A
5	PD-C

### 2. IMP-1550-20-PM Housing, No Internal PD

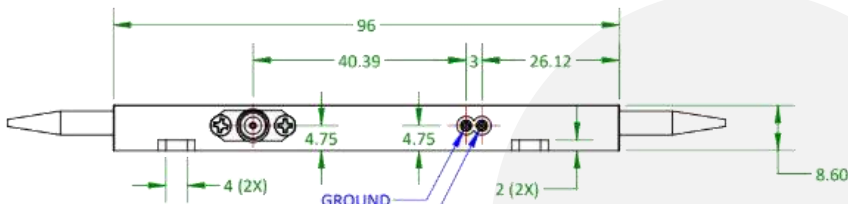
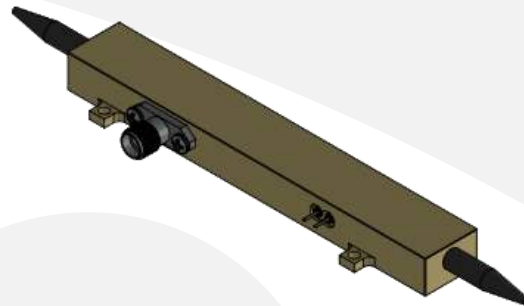

FRONT VIEW

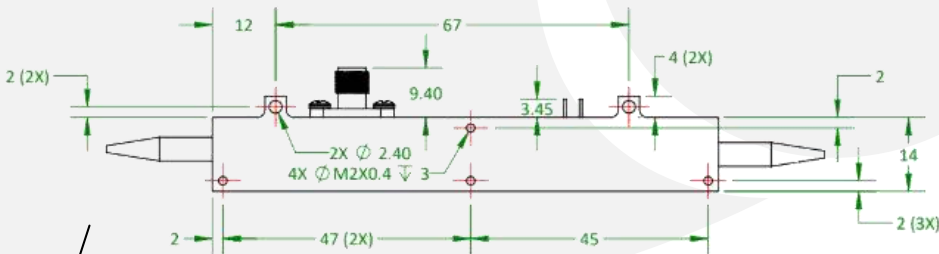

BOTTOM VIEW

PIN #	Symbol
G	GND
B	DC BIAS



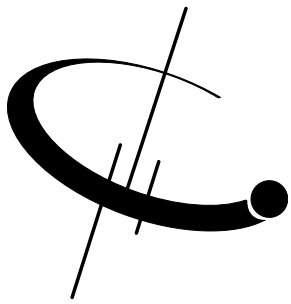

# IMP-1550-20-PM

ORDERING  
OPTIONS

**IMP-1550-20-PM-XX**  
**XX** PD: Internal PD

Available  
Accessories

- **BCB-4**

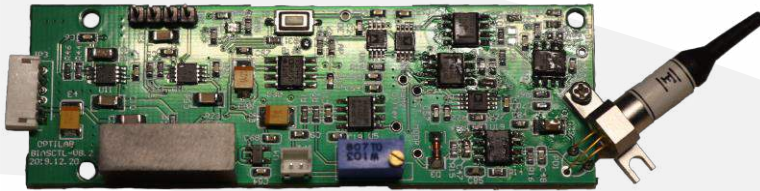

The Optilab BCB-4 is a compact bias control board designed for IMP-1550-20-PM modulator

- **DFB Laser Source**

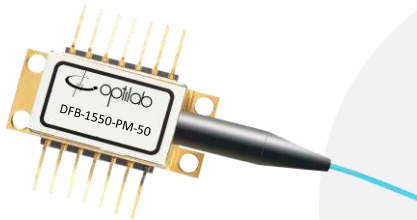

The Optilab DFB-1550-PM-50 laser has polarization maintaining high output power up to 50mW

