

Product Summary

$V_{(BR)DSS}$	Max $R_{DS(on)}$	Max I_D $T_A = +25^\circ C$
250V	8.5Ω @ $V_{GS} = 10V$	310mA

Description and Applications

This 250V enhancement mode N-Channel MOSFET provides users with a competitive specification offering efficient power handling capability, high impedance, and is free from thermal runaway and thermally induced secondary breakdown. Applications benefiting from this device include a variety of telecommunication and general high voltage circuits.

SOT89 and SOT23-6 versions are also available.

- Earth recall and dialing switches
- Electronic hook switches
- High voltage power MOSFET drivers
- Telecom call routers
- Solid state relays

SOT223 (Type DN)



Top View

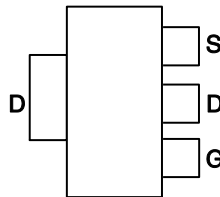

Pin Out Top-View

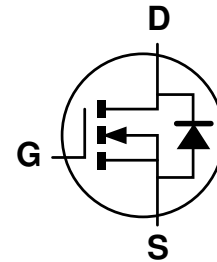

Equivalent Circuit

Features and Benefits

- High Voltage
- Low On-Resistance
- Fast Switching Speed
- Low Gate Drive
- Low Threshold
- Complementary P-Channel Type ZVP4525G
- **Lead-Free Finish; RoHS Compliant (Notes 1 & 2)**
- **Halogen and Antimony Free. "Green" Device (Note 3)**
- **For automotive applications requiring specific change control (i.e. parts qualified to AEC-Q100/101/200, PPAP capable, and manufactured in IATF 16949 certified facilities), please [contact us](mailto:contact@diodes.com) or your local Diodes representative. <https://www.diodes.com/quality/product-definitions/>**

Mechanical Data

- Package: SOT223 (Type DN)
- Package Material: Molded Plastic, "Green" Molding Compound; UL Flammability Classification Rating 94V-0
- Moisture Sensitivity: Level 1 per J-STD-020
- Terminals Connections: See Diagram Below
- Terminals: Finish - Matte Tin Annealed over Copper Leadframe; Solderable per MIL-STD-202, Method 208
- Weight: 0.112 grams (Approximate)

Ordering Information (Note 4)

Part Number	Package	Packing	
		Qty.	Carrier
ZVN4525GTA	SOT223 (Type DN)	1,000	Tape & Reel
ZVN4525GTC	SOT223 (Type DN)	4,000	Tape & Reel

- Notes:
1. EU Directive 2002/95/EC (RoHS), 2011/65/EU (RoHS 2) & 2015/863/EU (RoHS 3) compliant. All applicable RoHS exemptions applied.
 2. See <https://www.diodes.com/quality/lead-free/> for more information about Diodes Incorporated's definitions of Halogen- and Antimony-free, "Green" and Lead-free.
 3. Halogen- and Antimony-free "Green" products are defined as those which contain <900ppm bromine, <900ppm chlorine (<1500ppm total Br + Cl) and <1000ppm antimony compounds.
 4. For packaging details, go to our website at <https://www.diodes.com/design/support/packaging/diodes-packaging/>

Marking Information

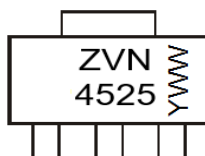

ZVN 4525 = Product Type Marking Code
 YWW = Date Code Marking
 Y or \bar{Y} = Last Digit of Year (ex: 1 = 2021)
 WW or $\bar{W}W$ = Week Code (01~53)

Maximum Ratings (@ $T_A = +25^\circ\text{C}$, unless otherwise specified.)

Characteristic	Symbol	Value	Unit
Drain-Source Voltage	V_{DSS}	250	V
Gate-Source Voltage	V_{GS}	± 40	V
Continuous Drain Current, $V_{GS} = 10\text{V}$ (Note 5)	I_D	$T_A = +25^\circ\text{C}$	310
		$T_A = +70^\circ\text{C}$	248
Pulsed Drain Current (Note 7)	I_{DM}	1.44	A
Continuous Source Current (Body Diode)	I_S	310	mA
Pulsed Source Current (Body Diode)	I_{SM}	1.44	A

Thermal Characteristics (@ $T_A = +25^\circ\text{C}$, unless otherwise specified.)

Characteristic	Symbol	Value	Unit
Power Dissipation at $T_A = +25^\circ\text{C}$ (Note 5)	P_D	2	W
Linear Derating Factor		16	mW/ $^\circ\text{C}$
Junction to Ambient (Note 5)	$R_{\theta JA}$	63	$^\circ\text{C}/\text{W}$
Junction to Ambient (Note 6)	$R_{\theta JA}$	26	$^\circ\text{C}/\text{W}$
Operating and Storage Temperature Range	T_J, T_{STG}	-55 to +150	$^\circ\text{C}$

- Notes:
5. For a device surface mounted on 25mm x 25mm FR4 PCB with high coverage of single sided 1oz copper, in still air conditions.
 6. For a device surface mounted on FR4 PCB measured at $t \leq 5$ seconds.
 7. Repetitive rating - pulse width limited by maximum junction temperature. Refer to Transient Thermal.

NB High Voltage Applications

For high voltage applications, the appropriate industry sector guidelines should be considered with regard to voltage spacing between conductors.

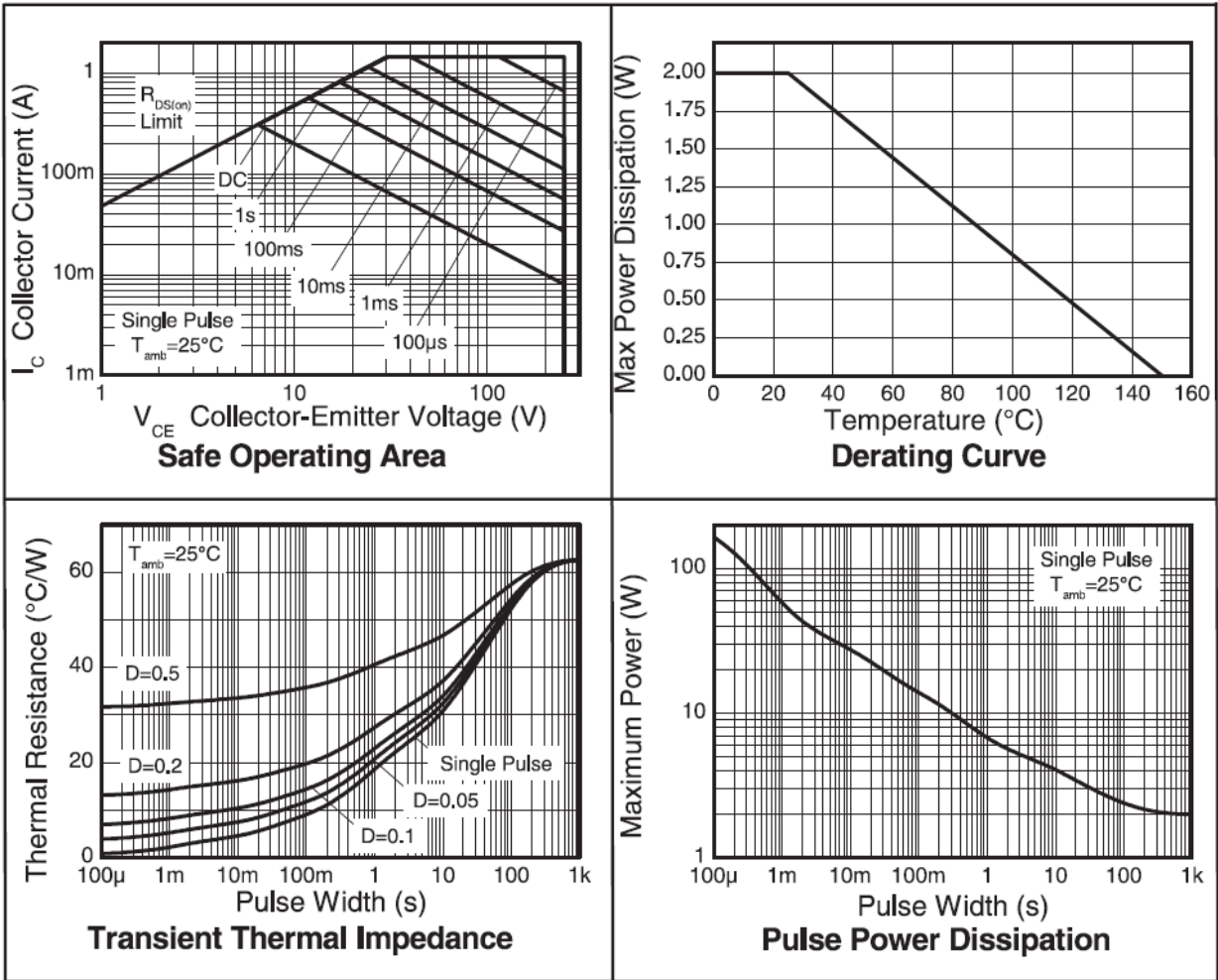

Electrical Characteristics (@ $T_A = +25^\circ\text{C}$, unless otherwise specified.)

Characteristic	Symbol	Min	Typ	Max	Unit	Test Condition
OFF CHARACTERISTICS						
Drain-Source Breakdown Voltage	BV_{DSS}	250	285	—	V	$I_D = 1\text{mA}$, $V_{GS} = 0\text{V}$
Zero Gate Voltage Drain Current	I_{DSS}	—	35	500	nA	$V_{DS} = 250\text{V}$, $V_{GS} = 0\text{V}$
Gate-Body Leakage	I_{GSS}	—	± 1	± 100	nA	$V_{GS} = \pm 40\text{V}$, $V_{DS} = 0\text{V}$
Gate-Source Threshold Voltage	$V_{GS(th)}$	0.8	1.4	1.8	V	$I_D = 1\text{mA}$, $V_{DS} = V_{GS}$
On-State Drain Current (Note 8)	$I_{D(on)}$	3	—	—	A	$V_{DS} = 25\text{V}$, $V_{GS} = 10\text{V}$
Static Drain-Source On-State Resistance (Note 8)	$R_{DS(on)}$	—	5.6	8.5	Ω	$V_{GS} = 10\text{V}$, $I_D = 500\text{mA}$
		—	5.9	9		$V_{GS} = 4.5\text{V}$, $I_D = 360\text{mA}$
		—	6.4	9.5		$V_{GS} = 2.5\text{V}$, $I_D = 20\text{mA}$
Forward Transconductance (Note 10)	g_{fs}	0.3	0.475	—	S	$V_{DS} = 10\text{V}$, $I_D = 0.3\text{A}$
Diode Forward Voltage (Note 8)	V_{SD}	—	—	0.97	V	$I_S = 360\text{mA}$, $V_{GS} = 0\text{V}$, $T_J = +25^\circ\text{C}$
DYNAMIC CHARACTERISTICS (Note 10)						
Input Capacitance	C_{iss}	—	72	—	pF	$V_{DS} = 25\text{V}$, $V_{GS} = 0\text{V}$ $f = 1\text{MHz}$
Output Capacitance	C_{oss}	—	11	—	pF	
Reverse Transfer Capacitance	C_{rss}	—	3.6	—	pF	
Total Gate Charge	Q_g	—	2.6	3.65	nC	$V_{DS} = 25\text{V}$, $V_{GS} = 10\text{V}$, $I_D = 360\text{mA}$ (refer to test circuit)
Gate-Source Charge	Q_{gs}	—	0.2	0.28		
Gate-Drain Charge	Q_{gd}	—	0.5	0.70		
Turn-On Delay Time (Note 9)	$t_{d(on)}$	—	1.25	—	ns	$V_{DD} = 30\text{V}$, $I_D = 360\text{mA}$, $R_G = 50\Omega$, $V_{GS} = 10\text{V}$ (refer to test circuit)
Rise Time (Note 9)	t_r	—	1.7	—		
Turn-Off Delay Time (Note 9)	$t_{d(off)}$	—	11.4	—		
Fall Time (Note 9)	t_f	—	3.5	—		
Reverse Recovery Time	t_{rr}	—	186	260	ns	$I_F = 360\text{mA}$, $di/dt = 100\text{A}/\mu\text{s}$, $T_J = +25^\circ\text{C}$
Reverse Recovery Charge	Q_{rr}	—	34	48	nC	

Notes: 8. Measured under pulsed conditions. Width=300 μs . Duty cycle $\leq 2\%$.
9. Switching characteristics are independent of operating junction temperature.
10. For design aid only, not subject to production testing.

Typical Characteristics

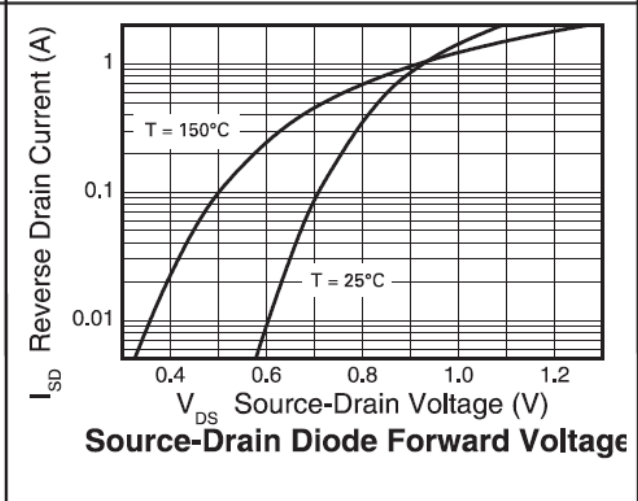
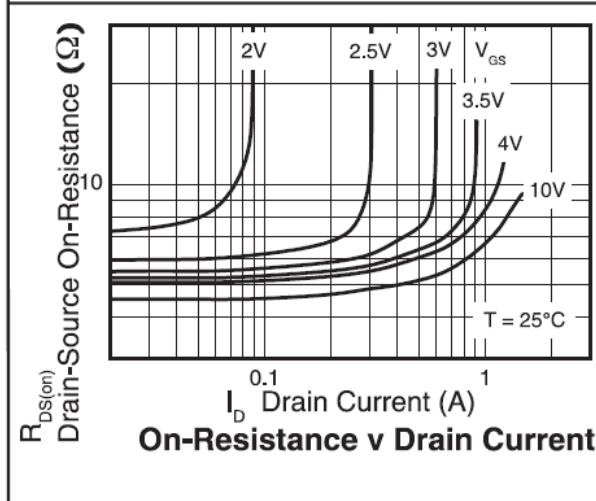
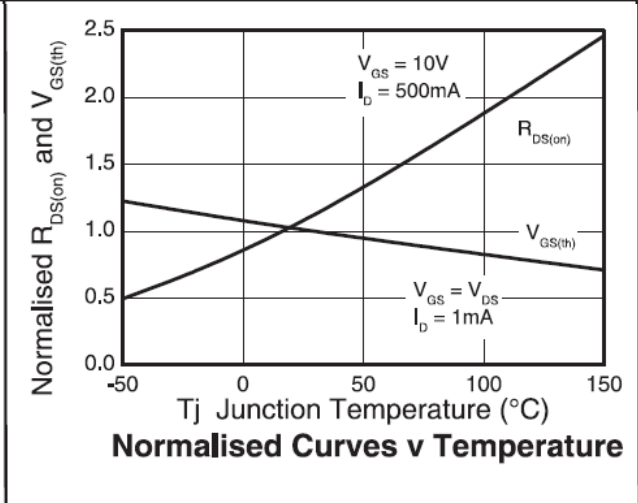
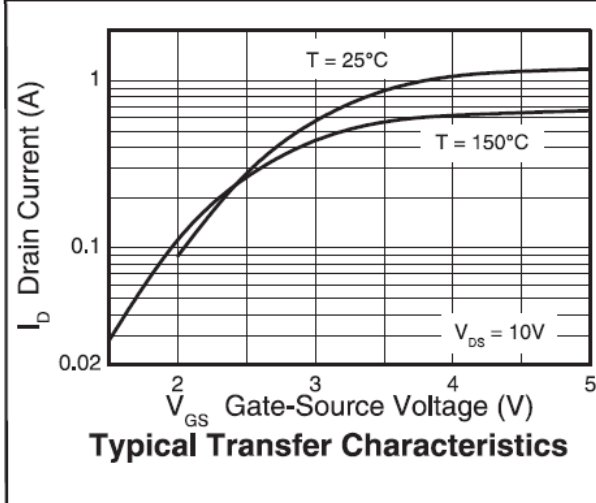
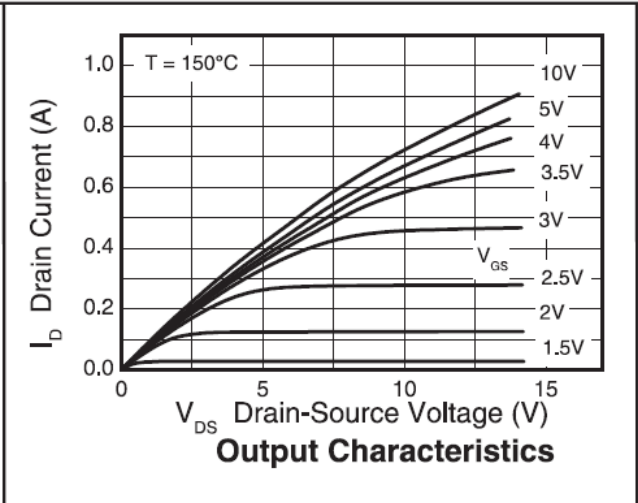
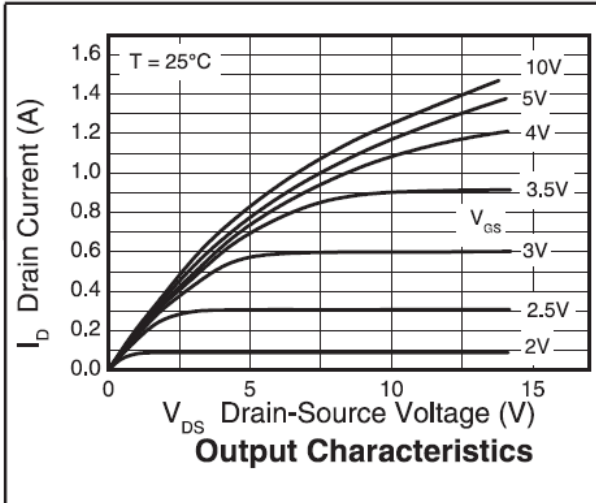

Typical Characteristics (continued)

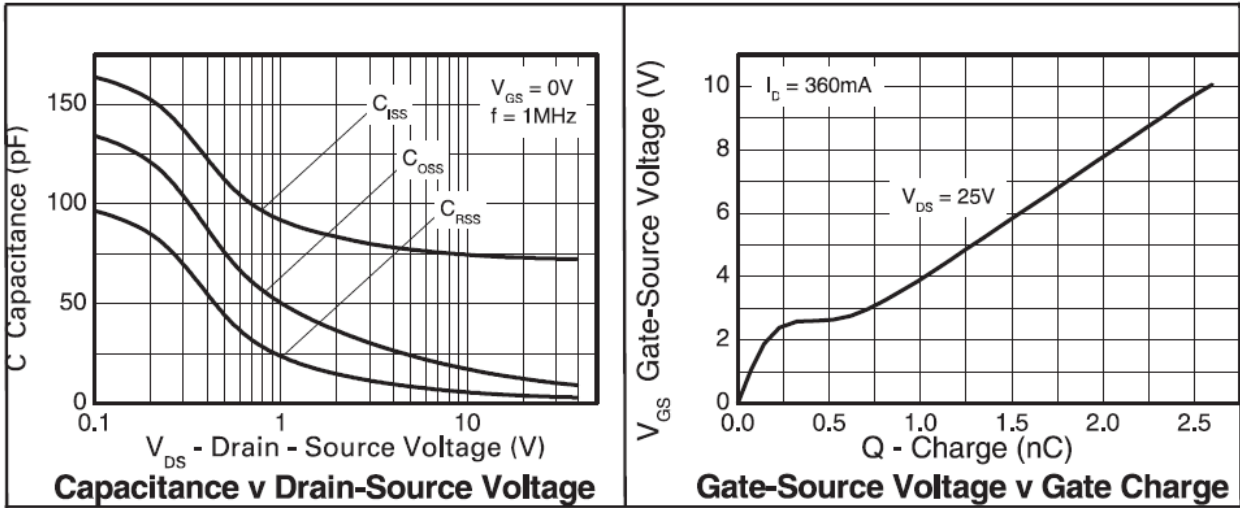

Package Outline Dimensions

Please see <http://www.diodes.com/package-outlines.html> for the latest version.

SOT223 (Type DN)

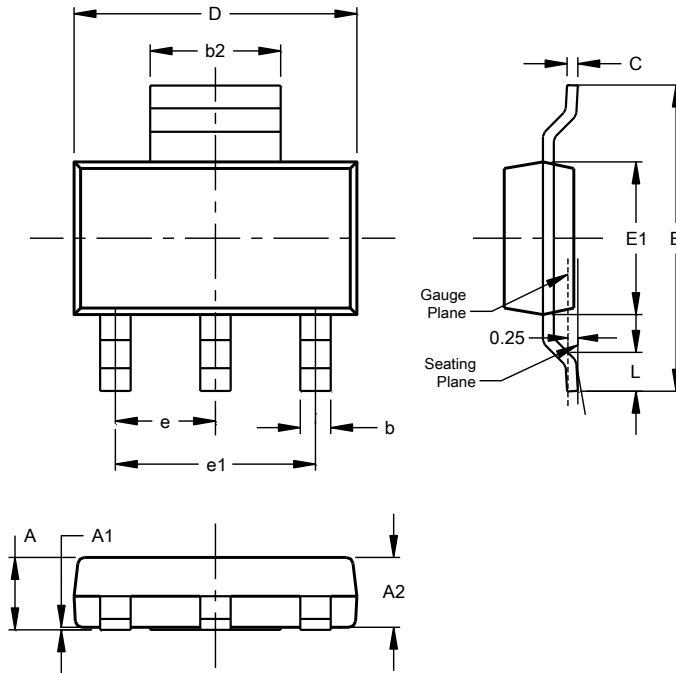

SOT223 (Type DN)			
Dim	Min	Max	Typ
A	--	1.70	--
A1	0.01	0.15	--
A2	1.50	1.68	1.60
b	0.60	0.80	0.70
b2	2.90	3.10	--
c	0.20	0.32	--
D	6.30	6.70	--
E	6.70	7.30	--
E1	3.30	3.70	--
e	--	--	2.30
e1	--	--	4.60
L	0.85	--	--
All Dimensions in mm			

Suggested Pad Layout

Please see <http://www.diodes.com/package-outlines.html> for the latest version.

SOT223 (Type DN)

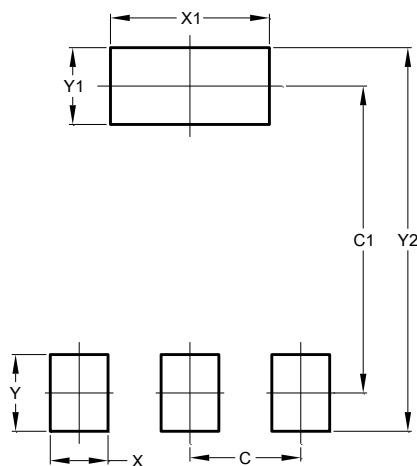

Dimensions	Value (in mm)
C	2.30
C1	6.40
X	1.20
X1	3.30
Y	1.60
Y1	1.60
Y2	8.00

IMPORTANT NOTICE

1. DIODES INCORPORATED AND ITS SUBSIDIARIES ("DIODES") MAKE NO WARRANTY OF ANY KIND, EXPRESS OR IMPLIED, WITH REGARDS TO ANY INFORMATION CONTAINED IN THIS DOCUMENT, INCLUDING, BUT NOT LIMITED TO, THE IMPLIED WARRANTIES OF MERCHANTABILITY, FITNESS FOR A PARTICULAR PURPOSE OR NON-INFRINGEMENT OF THIRD PARTY INTELLECTUAL PROPERTY RIGHTS (AND THEIR EQUIVALENTS UNDER THE LAWS OF ANY JURISDICTION).
2. The Information contained herein is for informational purpose only and is provided only to illustrate the operation of Diodes products described herein and application examples. Diodes does not assume any liability arising out of the application or use of this document or any product described herein. This document is intended for skilled and technically trained engineering customers and users who design with Diodes products. Diodes products may be used to facilitate safety-related applications; however, in all instances customers and users are responsible for (a) selecting the appropriate Diodes products for their applications, (b) evaluating the suitability of the Diodes products for their intended applications, (c) ensuring their applications, which incorporate Diodes products, comply the applicable legal and regulatory requirements as well as safety and functional-safety related standards, and (d) ensuring they design with appropriate safeguards (including testing, validation, quality control techniques, redundancy, malfunction prevention, and appropriate treatment for aging degradation) to minimize the risks associated with their applications.
3. Diodes assumes no liability for any application-related information, support, assistance or feedback that may be provided by Diodes from time to time. Any customer or user of this document or products described herein will assume all risks and liabilities associated with such use, and will hold Diodes and all companies whose products are represented herein or on Diodes' websites, harmless against all damages and liabilities.
4. Products described herein may be covered by one or more United States, international or foreign patents and pending patent applications. Product names and markings noted herein may also be covered by one or more United States, international or foreign trademarks and trademark applications. Diodes does not convey any license under any of its intellectual property rights or the rights of any third parties (including third parties whose products and services may be described in this document or on Diodes' website) under this document.
5. Diodes products are provided subject to Diodes' Standard Terms and Conditions of Sale (<https://www.diodes.com/about/company/terms-and-conditions/terms-and-conditions-of-sales/>) or other applicable terms. This document does not alter or expand the applicable warranties provided by Diodes. Diodes does not warrant or accept any liability whatsoever in respect of any products purchased through unauthorized sales channel.
6. Diodes products and technology may not be used for or incorporated into any products or systems whose manufacture, use or sale is prohibited under any applicable laws and regulations. Should customers or users use Diodes products in contravention of any applicable laws or regulations, or for any unintended or unauthorized application, customers and users will (a) be solely responsible for any damages, losses or penalties arising in connection therewith or as a result thereof, and (b) indemnify and hold Diodes and its representatives and agents harmless against any and all claims, damages, expenses, and attorney fees arising out of, directly or indirectly, any claim relating to any noncompliance with the applicable laws and regulations, as well as any unintended or unauthorized application.
7. While efforts have been made to ensure the information contained in this document is accurate, complete and current, it may contain technical inaccuracies, omissions and typographical errors. Diodes does not warrant that information contained in this document is error-free and Diodes is under no obligation to update or otherwise correct this information. Notwithstanding the foregoing, Diodes reserves the right to make modifications, enhancements, improvements, corrections or other changes without further notice to this document and any product described herein. This document is written in English but may be translated into multiple languages for reference. Only the English version of this document is the final and determinative format released by Diodes.
8. Any unauthorized copying, modification, distribution, transmission, display or other use of this document (or any portion hereof) is prohibited. Diodes assumes no responsibility for any losses incurred by the customers or users or any third parties arising from any such unauthorized use.

Copyright © 2022 Diodes Incorporated

www.diodes.com