

# Energy Management Power Analyzer Type WM14-96 "Basic Version"

CARLO GAVAZZI



- Optional dual pulse output
- Alarms (visual only)  $V_{LN}$ ,  $A_n$
- Optional galvanically insulated measuring inputs

## Product Description

3-phase power analyzer with built-in programming keypad. Particularly recommended for displaying the main electrical variables. Housing for panel mounting,

(front) protection degree IP65, and optional RS485 serial port or dual pulse output. Parameters programmable by means of CptBSoft.

- Class 1 (active energy)
- Class 2 (reactive energy)
- Accuracy  $\pm 0.5$  F.S. (current/voltage)
- Power analyzer
- Display of instantaneous variables: 3x3 digit
- Display of energies: 8+1 digit
- System variables and phase measurements:  $W$ ,  $W_{dmd}$ , var, VA,  $VA_{dmd}$ , PF, V, A,  $A_n$ ,  $A_{dmd}$ , Hz
- $A_{max}$ ,  $A_{dmd max}$ ,  $W_{dmd max}$  indication
- Energy measurements: kWh and kvarh
- Hour counter (5+2 DGT)
- TRMS meas. of distorted sine waves (voltages/currents)
- Power supply: 24V, 48V, 115V, 230V, 50-60Hz; 18 to 60VDC
- Protection degree (front): IP65
- Front dimensions: 96x96mm
- Optional RS422/485 serial port

## How to order WM14-96 AV5 3 D PG

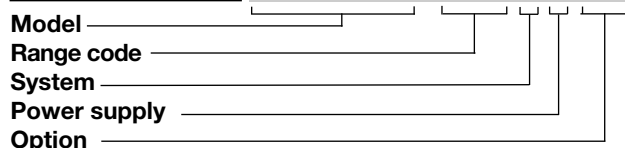

## How to order CptBSoft

CptBSoft (compatible only with S or SG options): software to program the working parameters of the power analyzer and to read the energy and the instantaneous variables.

## Type Selection

Range codes	System	Power supply	Options
<b>AV5:</b> 380/660 $V_{L-L}$ /5(6)AAC VL-N: 185 V to 460 V VL-L: 320 V to 800 V <b>AV6:</b> 120/208 $V_{L-L}$ /5(6)AAC VL-N: 45 V to 145 V VL-L: 78 V to 250 V Phase current: 0.03A to 6A Neutral current: 0.09 to 6A	<b>3:</b> 1-2-3-phase, balanced/unbalanced load, with or without neutral	<b>A:</b> 24VAC -15+10%, 50-60Hz <b>B:</b> 48VAC -15+10%, 50-60Hz <b>C:</b> 115VAC -15+10%, 50-60Hz <b>D:</b> 230VAC -15+10%, 50-60Hz <b>3:</b> 18 to 60VDC (not available in case of SG or PG options)	<b>X:</b> None <b>S:</b> RS485 port <b>SG:</b> RS485+galvanic insulated measuring inputs <b>PG:</b> Dual pulse output + galvanically insulated measuring inputs.

## Input specifications

<b>Rated inputs</b> Current "X-S options" Current "SG-PG options" Voltage	3 (non insulated each other) 3 (insulated each other) 4	Active energy "X-S option" Reactive energy "X-S option" Active energy "SG-PG opt." Reactive energy "SG-PG opt." Frequency	0.03A to 0.25A: $\pm 2\%$ FS +5DGT) Class 2 (start up "I": 30mA) Class 3 (start up "I": 30mA) Class 1 (start up "I": 30mA) Class 2 (start up "I": 30mA) Class 2 (start up "I": 30mA) $\pm 0.1$ Hz (48 to 62Hz)
<b>Accuracy</b> (display, RS485) (@25°C $\pm 5^\circ$ C, R.H. $\leq 60\%$ )	with CT=1 and VT=1 AV5: 1150W-VA-var, FS:230VLN, 400VLL; AV6: 285W-VA-var, FS:57VLN, 100VLL	<b>Additional errors</b> Humidity	$\leq 0.3\%$ FS, 60% to 90% RH
Current	0.25 to 6A: $\pm(0.5\%$ FS +1DGT) 0.03A to 0.25A: $\pm(0.5\%$ FS+7DGT)	<b>Temperature drift</b>	$\leq 200$ ppm/ $^\circ$ C
Neutral current	0.25 to 6A: $\pm(1.5\%$ FS +1DGT) 0.09A to 0.25A: $\pm(0.5\%$ FS+7DGT)	<b>Sampling rate</b>	1400 samples/s @ 50Hz 1700 samples/s @ 60Hz
Phase-phase voltage	$\pm(1.5\%$ FS +1 DGT)	<b>Display refresh time</b>	700ms
Phase-neutral voltage	$\pm(0.5\%$ FS + 1 DGT)	<b>Display</b>	
Active and Apparent power,	0.25 to 6A: $\pm(1\%$ FS +1DGT); 0.03A to 0.25A: $\pm(1\%$ FS +5DGT)	Type	LED, 14mm
Reactive power	0.25 to 6A: $\pm(2\%$ FS +1DGT);	Read-out for instant. var.	3x3 DGT
		Read-out for energies	3+3+3 DGT (Max indication: 999 999 99.9)



## Input specifications (cont.)

<b>Display (cont.)</b> Read-out for hour counter	1+3+3 DGT (Max. indication: 9 999 9.99)	<b>Input impedance</b> 380/660V <sub>L-L</sub> (AV5) 120/208V <sub>L-L</sub> (AV6) Current	<b>(X-S options)</b> 1 MΩ ±5% 453 KΩ ±5% ≤ 0.02Ω
<b>Measurements</b>	Current, voltage, power, power factor, frequency, energy, TRMS measurement of distorted waves.	<b>Input impedance</b> 380/660V <sub>L-L</sub> (AV5) 120/208V <sub>L-L</sub> (AV6) Current	<b>(PG-SG options)</b> 1 MΩ ±1% 1 MΩ ±1% ≤ 0.02Ω
Coupling type Crest factor	Direct < 3, max 10A peak	<b>Frequency</b>	48 to 62 Hz
		<b>Overload protection</b> Continuous voltage/current For 500ms: voltage/current	1.2 F.S. 2 Un/36A

## RS485 Serial Port Specifications

<b>RS422/RS485</b> (on request) Type	Multidrop bidirectional (static and dynamic variables)	Data (bidirectional) Dynamic (reading only)	System, phase variables and energies
Connections	2 or 4 wires, max. distance 1200m, termination directly on the instrument	Static (writing only) Data format	All configuration parameters 1 bit di start , 8 data bit, no parity, 1 stop bit
Addresses Protocol	1 to 255, key-pad selectable MODBUS/JBUS	Baud-rate	9600 bit/s

## CptBSoft software: parameter programming and reading data

<b>CptBSoft</b>	Multi language software to program the working parameters of the power analyzer and to read the energies and the instantaneous variables. The program runs under Windows 95/98/98SE/2000/	<b>Working mode</b>	NT/XP. Two different working modes can be selected: - management of a local RS485 network; - management of communication from a single instrument to PC (RS232);
		<b>Data access</b>	By means of RS485 serial port.

## Dual pulse output

<b>Digital outputs</b> (on request) Pulse outputs Number of outputs Number of pulses	2 (one for kWh one for kvarh) From 0.01 to 999 in compliance with the following formula: <b>[Psys max (kW or kvar)*pulses (pulses/kWh or kvarh)] &lt;14400</b>	<b>Pulse duration</b>	Electrical life: min 2*10 <sup>5</sup> cycles Mechanical life: 5*10 <sup>6</sup> cycles ≥100ms <120ms (ON) ≥100ms (OFF) According to EN622053-31
Output type	Relay min current 0.05A@250VAC/30VDC max current 5A@250VAC/30VDC	<b>Insulation</b>	By means of relays, 4000 V <sub>RMS</sub> outputs to measuring inputs, 4000 V <sub>RMS</sub> output to supply input. Insulation between the two outputs: 1000V <sub>RMS</sub>

## Software functions

<b>Password</b>	Numeric code of max. 3 digits; 2 protection levels of the programming data Password "0", no protection		
1st level	Password from 1 to 999, all data are protected		
2nd level			
<b>System selection</b>	3-phase with/without n, unbal. 3-phase balanced 3-phase ARON, unbalanced 2-phase Single phase		Page 5: An, An Alarm Page 6: W L1, W L2, W L3 Page 7: PF L1, PF L2, PF L3 Page 8: var L1, var L2, var L3 Page 9: VA L1, VA L2, VA L3 Page 10: VA $\Sigma$ , W $\Sigma$ , var $\Sigma$ Page 11: VA dmd, W dmd, Hz Page 12: W dmd max (*) Page 13: Wh (*) Page 14: varh (*) Page 15: VL-L $\Sigma$ , PF $\Sigma$ , VLN Alarm Page 16: A max (*) Page 17: A dmd max (*) Page 18: hour counter (*) (*) = These variables are stored in EEPROM when the instrument is switched off
<b>Transformer ratio</b>			
CT	1 to 999		
VT	1.0 to 99.9		
<b>Filter</b>			
Operating range	0 to 100% of the input display scale		
Filtering coefficient	1 to 16		
Filter action	Measurements, alarms, serial out. (fundamental var: V, A, W and their derived ones).	<b>Alarms</b>	Programmable, for the VL $\Sigma$ and An (neutral current). Note: the alarm is only visual, by means of LED on the front of the instrument.
<b>Displaying</b>		<b>Reset</b>	Independent alarm (VL $\Sigma$ , An) max: A dmd, W dmd all energies (Wh, varh) and hour counter
3-phase system with neutral	Up to 3 variables per page Page 1: V L1, V L2, V L3 Page 2: V L12, V L23, V L31 Page 3: A L1, A L2, A L3 Page 4: A L1 dmd, A L2 dmd, A L3 dmd		

## Power Supply Specifications

<b>Auxiliary power supply</b>	230VAC -15 +10%, 50-60Hz 115VAC -15 +10%, 50-60Hz 48VAC -15 +10%, 50-60Hz		24VAC -15 +10%, 50-60Hz 18 to 60VDC
		<b>Power consumption</b>	AC: 4.5 VA DC: 4W

## General Specifications

<b>Operating temperature</b>	0 to +50°C (32 to 122°F) (RH < 90% non condensing)		measuring inputs and RS485. 4000VAC, 500VDC between power supply and RS485
<b>Storage temperature</b>	-30 to +60°C (-22 to 140°F) (RH < 90% non condensing)	<b>Dielectric strength</b>	4000 VAC (for 1 min)
<b>Installation category</b>	Cat. III (IEC 60664, EN60664)	<b>EMC</b>	
<b>Insulation (for 1 minute)</b>	4000VAC, 500VDC between measuring inputs and power supply. 500VAC/DC between	Emissions	EN50084-1 (class A) residential environment, commerce and light industry



## General Specifications (cont.)

<b>EMC (cont.)</b> Immunity	EN61000-6-2 (class A) industrial environment.	<b>Housing</b> Dimensions (WxHxD) Material	96 x 96 x 63 mm ABS self-extinguishing: UL 94 V-0
<b>Pulse voltage (1.2/50µs)</b>	EN61000-4-5	<b>Mounting</b>	Panel
<b>Safety standards</b>	IEC60664, EN60664	<b>Protection degree</b>	Front: IP65 (standard), NEMA4x, NEMA12 Connections: IP20
<b>Approvals</b>	CE, cULus	<b>Weight</b>	Approx. 400 g (pack. incl.)
<b>Connections 5(6) A</b> Max cable cross sect. area	Screw-type 2.5 mm <sup>2</sup>		

## Display pages

### Display variables in 3-phase systems (in a 3-phase system with neutral)

No	1 <sup>st</sup> variable	2 <sup>nd</sup> variable	3 <sup>rd</sup> variable	Note
1	V L1	V L2	V L3	
2	V L12	V L23	V L31 of the display	Decimal point blinking on the right
3	A L1	A L2	A L3	
4	A L1 dmd	A L2 dmd	A L3 dmd	dmd = demand (integration time selectable from 1 to 30 minutes)
5	An	AL.n		AL.n if neutral current alarm is active
6	W L1	W L2	W L3	Decimal point blinking on the right of the display if generated power
7	PF L1	PF L2	PF L3	
8	var L1	var L2	var L3	Decimal point blinking on the right of the display if generated power
9	VA L1	VA L2	VA L3	
10	VA system	W system	var system	
11	VA dmd (system)	W dmd (system)	Hz (system)	dmd = demand (integration time selectable from 1 to 30 minutes)
12		W dmd MAX		Maximum sys power demand
13	Wh (MSD)	Wh	Wh (LSD)	The total indication is given in max 3 groups of 3 digits.
14	varh (MSD)	varh	varh (LSD)	The total indication is given in max 3 groups of 3 digits.
15	V LL system	AL.U	PF system	AL.U= is activated only if one of VLN is not within the set limits.
16	A MAX			max. current among the three phases
17	A dmd max			max. dmd current among the three phases
18	h			hour counter

MSD: most significant digit

LSD: least significant digit

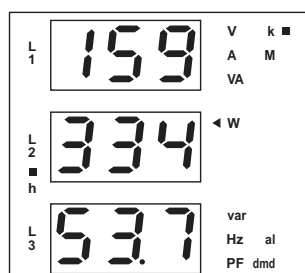

#### 1) Example of kWh visualization:

This example is showing 15 933 453.7 kWh

#### 2) Example of kvarh visualization:

This example is showing 3 553 944.9 kvarh

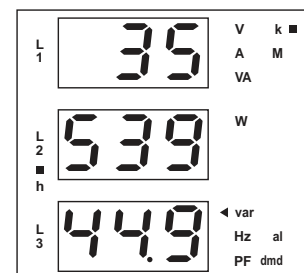

Waveform of the signals that can be measured

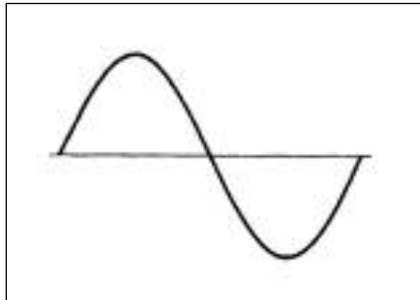

**Figure A**  
**Sine wave, undistorted**  
 Fundamental content 100%  
 Harmonic content 0%  
 $A_{rms} = 1.1107 | \bar{A} |$

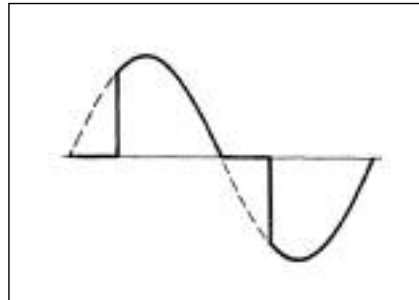

**Figure B**  
**Sine wave, indented**  
 Fundamental content 10...100%  
 Harmonic content 0...90%  
 Frequency spectrum: 3rd to 16th harmonic  
 Additional error: <1% FS

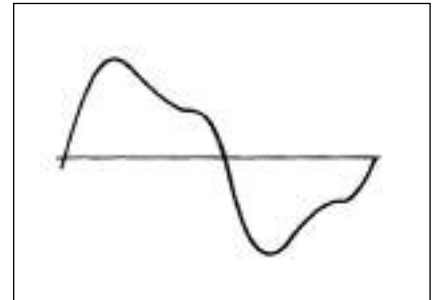

**Figure C**  
**Sine wave, distorted**  
 Fundamental content 70...90%  
 Harmonic content 10...30%  
 Frequency spectrum: 3rd to 16th harmonic  
 Additional error: <0.5% FS

**Accuracy**

kWh, accuracy (RDG) depending on the current

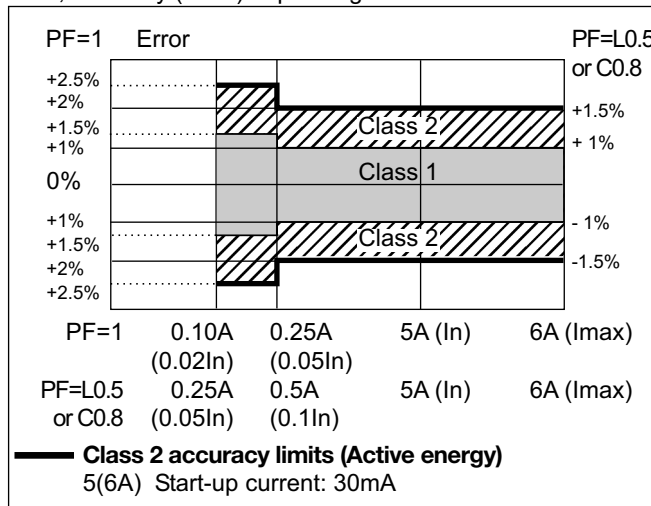

kvarh, accuracy (RDG) depending on the current

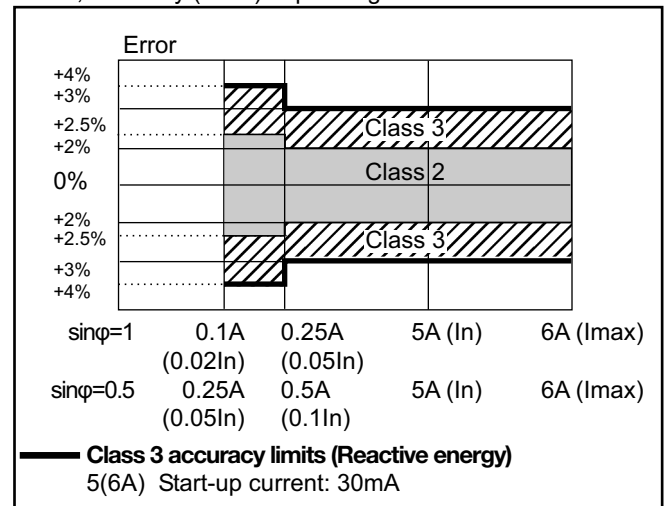

: this graph is only referred to instrument models with the "SG or PG" option.

: this graph is only referred to instrument models with the "X or S" option.

**Used calculation formulas**

**Phase variables**

Instantaneous effective voltage

$$V_{IN} = \sqrt{\frac{1}{n} \cdot \sum_{i=1}^n (V_{INi})^2}$$

Instantaneous active power

$$W_1 = \frac{1}{n} \cdot \sum_{i=1}^n (V_{INi}) \cdot (A_i)_i$$

Instantaneous power factor

$$\cos\phi_1 = \frac{W_1}{VA_1}$$

Instantaneous effective current

$$A_1 = \sqrt{\frac{1}{n} \cdot \sum_{i=1}^n (A_i)_i^2}$$

Instantaneous apparent power

$$VA_1 = V_{IN} \cdot A_1$$

Instantaneous reactive power

$$VAR_1 = \sqrt{(VA_1)^2 - (W_1)^2}$$

**System variables**

Equivalent 3-phase voltage

$$V_{\Sigma} = \frac{V_1 + V_2 + V_3}{3} \cdot \sqrt{3}$$

3-phase reactive power

$$VAR_{\Sigma} = (VAR_1 + VAR_2 + VAR_3)$$

3-phase active power

$$W_{\Sigma} = W_1 + W_2 + W_3$$

3-phase apparent power

$$VA_{\Sigma} = \sqrt{W_{\Sigma}^2 + VAR_{\Sigma}^2}$$

3-phase power factor

$$\cos\phi_{\Sigma} = \frac{W_{\Sigma}}{VA_{\Sigma}}$$

Neutral current

$$An = \bar{A}_{L1} + \bar{A}_{L2} + \bar{A}_{L3}$$

## Used calculation formulas (cont.)

$$kWh_i = \int_{t_1}^{t_2} P_i(t) dt \approx \Delta t \sum_{n_1}^{n_2} P_{i,j}$$

$$kVarh_i = \int_{t_1}^{t_2} Q_i(t) dt \approx \Delta t \sum_{n_1}^{n_2} Q_{i,j}$$

### Energy metering

Where:

i = considered phase (L1, L2 or L3)

P = active power

Q = reactive power

t<sub>1</sub>, t<sub>2</sub> = starting and ending time points of consumption recording

n = time unit

Δt = time interval between two successive power consumptions

n<sub>1</sub>, n<sub>2</sub> = starting and ending discrete time points of consumption recording

## Wiring diagrams

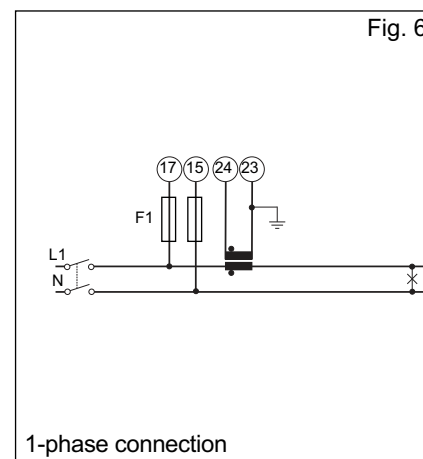
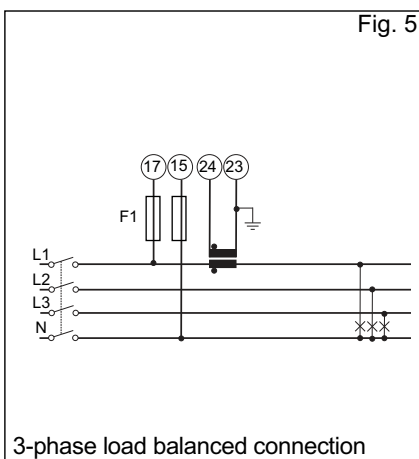
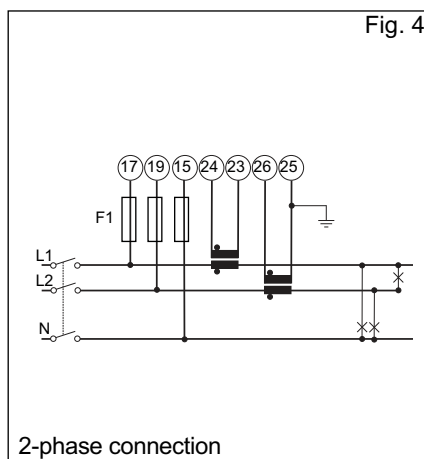
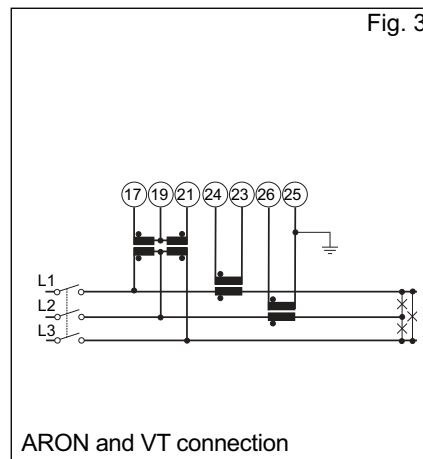
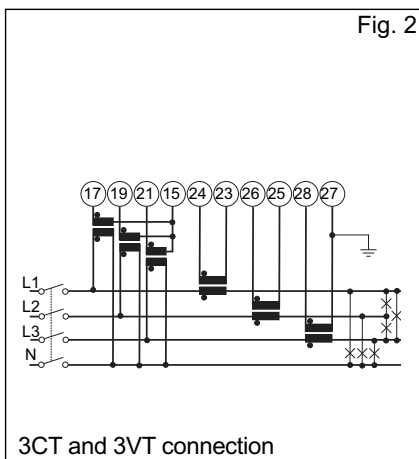
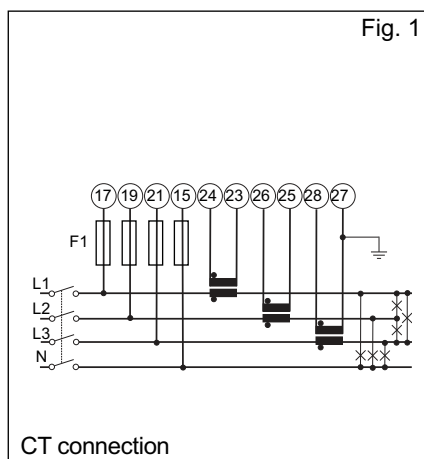

F1= 315mA

**NOTE:** Only for “PG” and “SG” options: the current measuring inputs are galvanically insulated and therefore they can be connected to ground singly.

**NOTE:** For all models except for “PG” or “SG” the current inputs can be connected to the lines ONLY by means of current transformers. The direct connection is not allowed.

**ATTENTION:** only one ammeter input can be connected to earth, as shown in the electrical diagrams.

### RS485 port connections

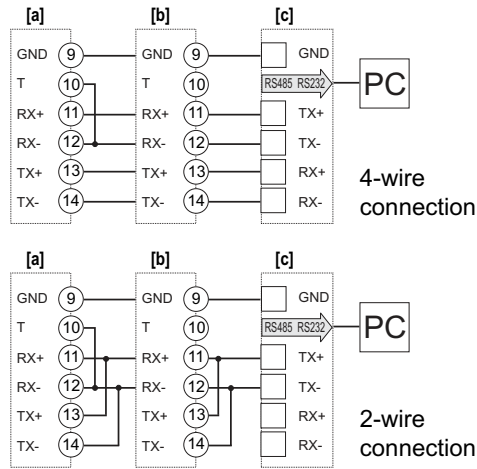

Fig. 7: **a**-Last instrument; **b**-1...n Instrument  
**c**-RS485/232 serial converter

### Dual pulse output connections

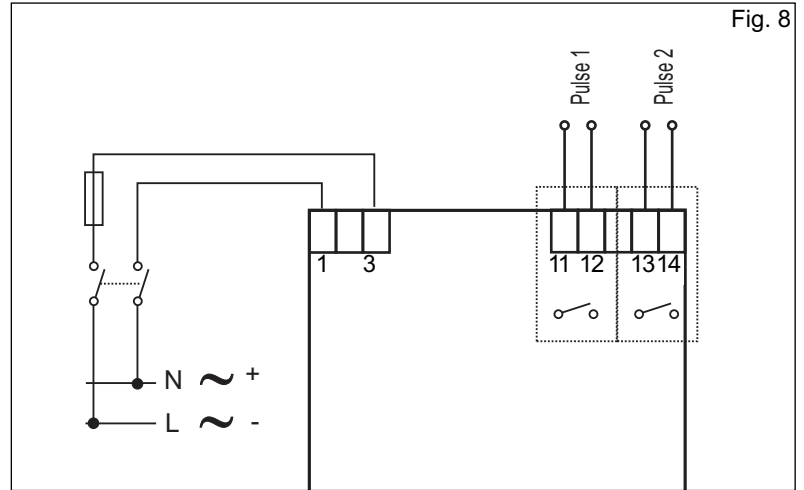
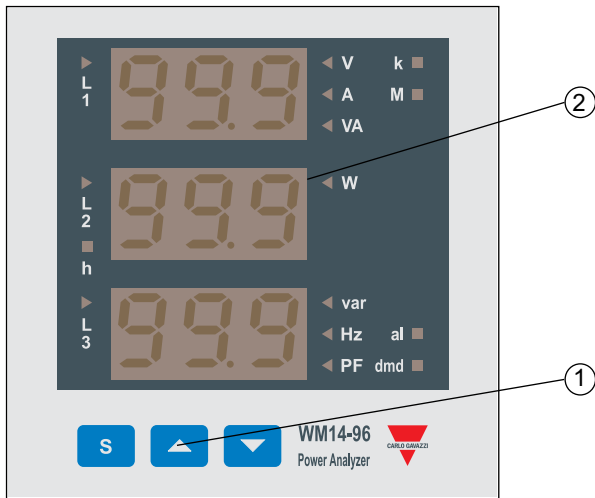

Fig. 8

### Front Panel Description



**1. Key-pad**

To program the configuration parameters and the display of the variables.



Key to enter programming and confirm selections;



Keys to:

- programme values;
- select functions;
- display measuring pages.

**2. Display**

LED-type with alphanumeric indications to:

- display configuration parameters;
- display all the measured variables.

### Dimensions and Panel Cut-out

