

**2SC2271**



2006A

(T-31-23

NPN Triple Diffused Planar Silicon Transistor

## Chroma Output, Horizontal Deflection Driver Applications

©493E

Small-sized color TV chroma use and B/W TV, color TV horizontal deflection driver use.

### Absolute Maximum Ratings at Ta=25°C

			unit
Collector to Base Voltage	VCBO	300	V
Collector to Emitter Voltage	VCEO	300	V
Emitter to Base Voltage	VEBO	6	V
Collector Current	IC	100	mA
Peak Collector Current	icp	300	mA
Collector Dissipation	PC	900	mW
Junction Temperature	Tj	150	°C
Storage Temperature	Tstg	-55 to +150	°C

### Electrical Characteristics at Ta=25°C

			min	typ	max	unit
Collector Cut Off Current	ICBO	V <sub>CB</sub> =200V, I <sub>E</sub> =0			1.0	uA
Emitter Cut Off Current	IEBO	V <sub>EB</sub> =6V, I <sub>C</sub> =0			1.0	uA
DC Current Gain	hFE	V <sub>CE</sub> =10V, I <sub>C</sub> =10mA	40*		200*	
Gain Band Width Product	fT	V <sub>CE</sub> =30V, I <sub>C</sub> =10mA	50			MHz
Output Capacitance	cob	V <sub>CB</sub> =10V, f=1MHz			7.5	pF
C-E Saturation Voltage	VCE(sat)	) I <sub>C</sub> =20mA, I <sub>B</sub> =2mA			0.6	V
B-E Saturation Voltage	VBE(sat)				1.0	V

\* The 2SC2271 is classified by 10mA hFE as follows.

40	C	80	60	D	120	100	E	200
----	---	----	----	---	-----	-----	---	-----

Case Outline 2006A (unit:mm)

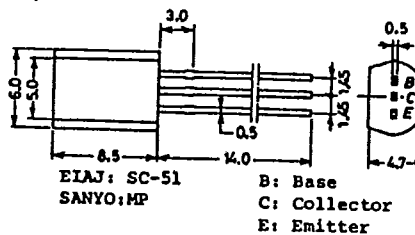

The 2SC2271 is scheduled to be discontinued soon. Use the 2SC3468, instead of the 2SC2271, in new applications where you are planning to use the 2SC2271.

4157KI/3195MW, TS No.493-1/2

T-91-20

# CASE OUTLINES AND ATTACHMENTS

- All of Sanyo Transistor case outlines are illustrated below.
- All dimensions are in mm, and dimensions which are not followed by min. or max. are represented by typical values.
- No marking is indicated.

Case Outline-[2003A]

unit:mm

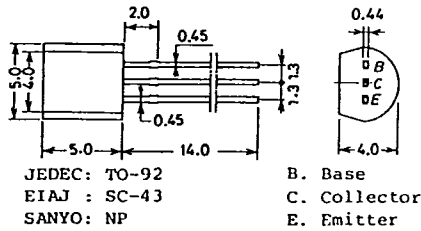

Case Outline-[2009A]

unit:mm

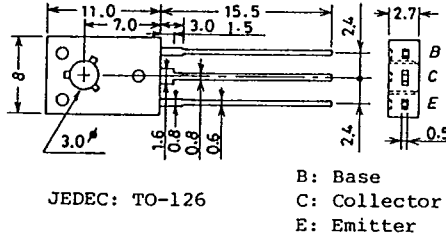

Case Outline-[2004A]

unit:mm

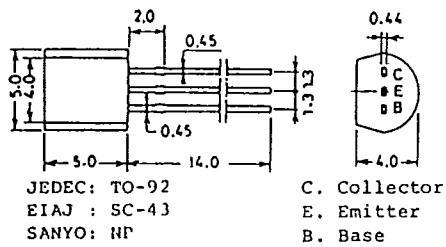

Case Outline-[2010A]

unit:mm

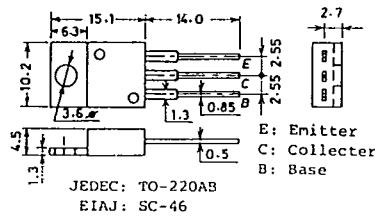

Case Outline-[2005A]

unit:mm

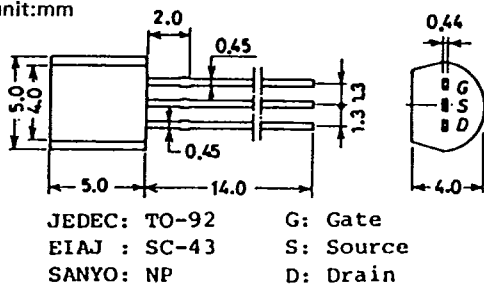

Case Outline-[2012]

unit:mm

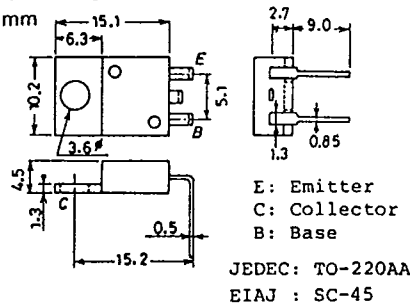

Case Outline-[2006A]

unit:mm

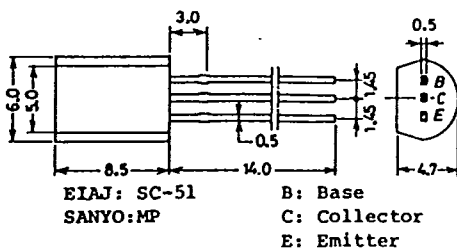

Case Outline-[2013]

unit:mm

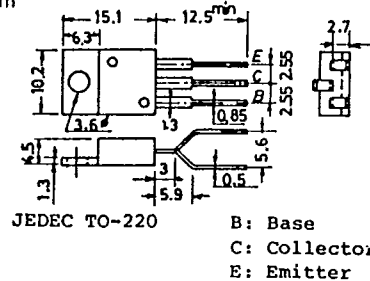

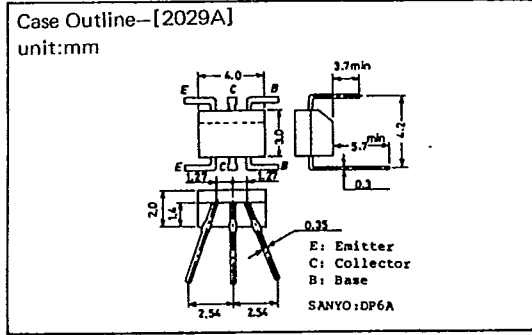
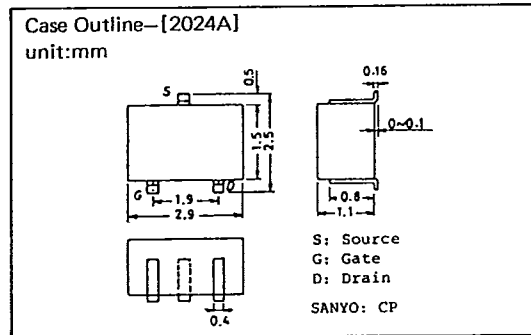
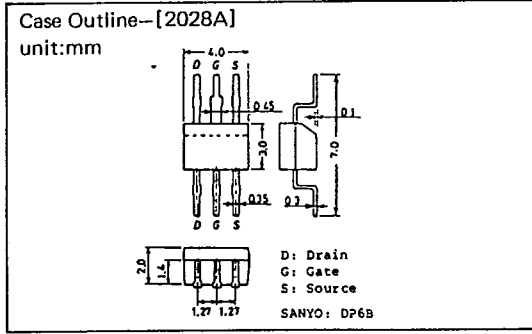
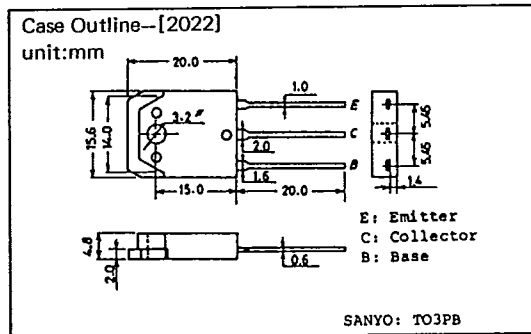
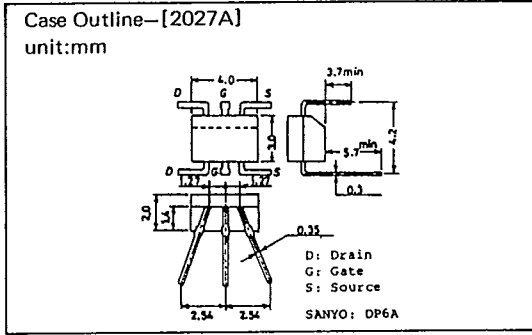
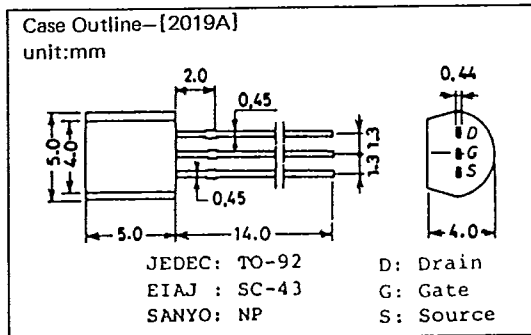
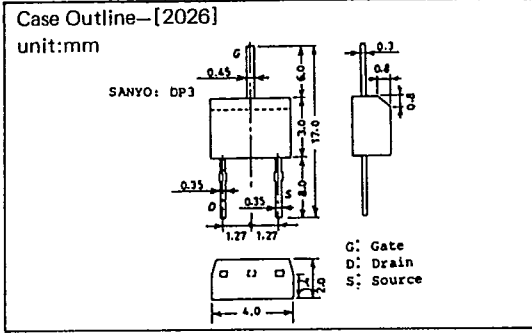
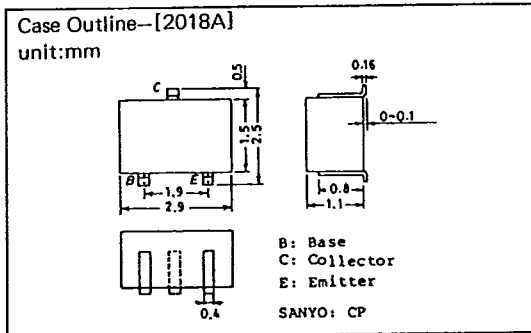
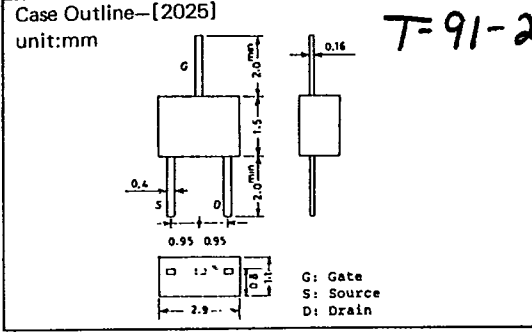
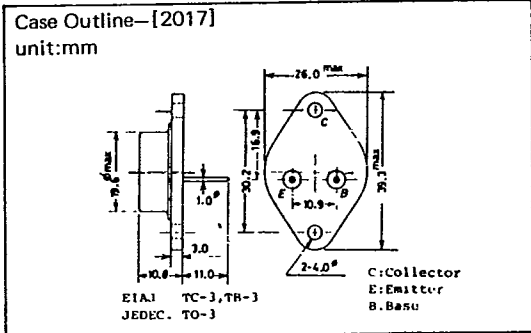

T-91-20

Case Outline-[2030A]  
unit:mm

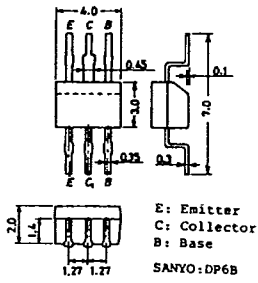

E: Emitter  
C: Collector  
B: Base  
SANYO: DP6B

Case Outline-[2038]  
unit:mm

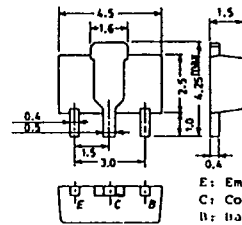

E: Emitter  
C: Collector  
B: Base  
SANYO: PC1'

Case Outline-[2031A]  
unit:mm

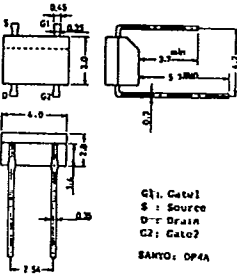

G1: Gate1  
S: Source  
D: Drain  
G2: Gate2  
SANYO: DP4A

Case Outline-[2039]  
unit:mm

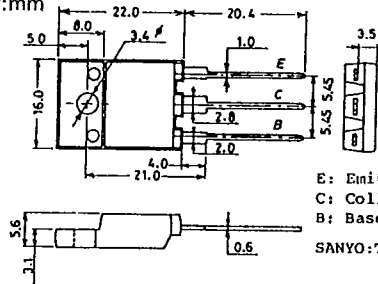

E: Emitter  
C: Collector  
B: Base  
SANYO: TO3PML

Case Outline-[2033]  
unit:mm

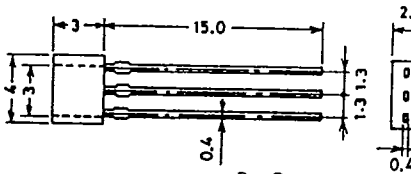

B: Base  
C: Collector  
E: Emitter  
SANYO: SPA

Case Outline-[2040]  
unit:mm

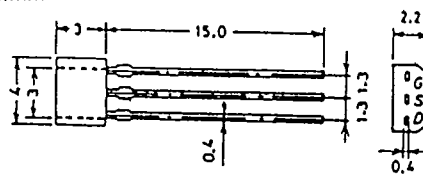

G: Gate  
S: Source  
D: Drain  
SANYO: SPA

Case Outline-[2034]  
unit:mm

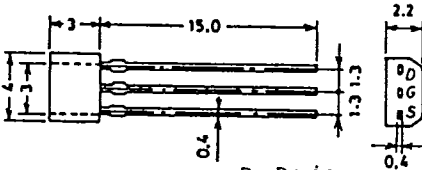

D: Drain  
G: Gate  
S: Source  
SANYO: SPA

Case Outline-[2041]  
unit:mm

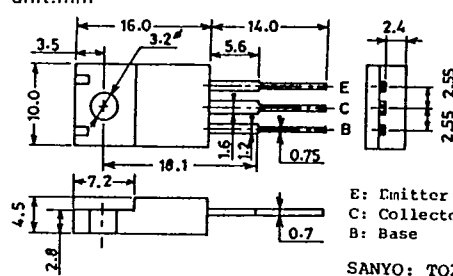

E: Emitter  
C: Collector  
B: Base  
SANYO: TO220ML

Case Outline-[2037]  
unit:mm

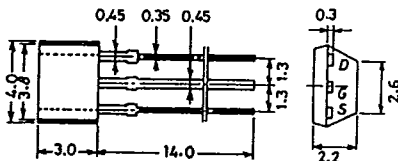

D: Drain  
G: Gate  
S: Source  
SANYO: SP'

Case Outline-[2042A] unit:mm

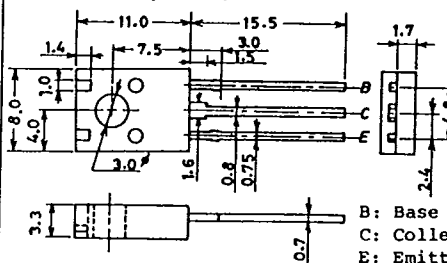

B: Base  
C: Collector  
E: Emitter  
SANYO: TO126ML

T-91-20

