

104483-1 ✓ ACTIVE

AMPMODU | AMPMODU IV/V

TE Internal #: 104483-1

Housing, Receptacle, Wire-to-Board, 8 Position, .1 in [2.54 mm]

Centerline, Crimp, 2 Row, Black, Wire & Cable, Signal, AMPMODU IV/V

[View on TE.com >](#)



Connectors > PCB Connectors > Wire-to-Board Connectors > Wire-to-Board Connector Assemblies & Housings



Connector Product Type: **Housing**

Connector & Housing Type: **Receptacle**

Connector System: **Wire-to-Board**

Number of Positions: **8**

Centerline (Pitch): **2.54 mm [.1 in]**

Features

Product Type Features

Connector Product Type	Housing
Connector & Housing Type	Receptacle
Connector System	Wire-to-Board
Connector & Contact Terminates To	Wire & Cable

Configuration Features

Number of Positions	8
Number of Rows	2

Electrical Characteristics

Termination Resistance	12 mΩ
Insulation Resistance	5000 MΩ
Dielectric Withstanding Voltage (Max)	750 V
Operating Voltage	300 VAC

Body Features

Primary Product Color	Black
-----------------------	-------

Contact Features

Contact Type	Socket
Contact Current Rating (Max)	3 A

Termination Features

Termination Method to Wire & Cable	Crimp
------------------------------------	-------

Mechanical Attachment

Strain Relief	Without
---------------	---------

Panel Mount Feature	Without
---------------------	---------

PCB Mount Retention	Without
---------------------	---------

Mating Retention	Without
------------------	---------

Housing Features

Housing Entry Configuration	Both Ends Closed
-----------------------------	------------------

Housing Material	Thermoplastic
------------------	---------------

Centerline (Pitch)	2.54 mm[.1 in]
--------------------	----------------

Dimensions

Connector Length	10.1 mm
------------------	---------

Connector Height	5.02 mm
------------------	---------

Wire Size	.03 – .5 mm ²
-----------	--------------------------

Row-to-Row Spacing	2.54 mm[.1 in]
--------------------	----------------

Usage Conditions

Operating Temperature Range	-65 – 105 °C[-85 – 221 °F]
-----------------------------	----------------------------

Operation/Application

Circuit Application	Signal
---------------------	--------

Industry Standards

Approved Standards	CSA LR7189, UL E28476
--------------------	-----------------------

UL Flammability Rating	UL 94V-0
------------------------	----------

Packaging Features

Packaging Quantity	1
--------------------	---

Packaging Method	Package
------------------	---------

Product Compliance

[For compliance documentation, visit the product page on TE.com>](#)

EU RoHS Directive 2011/65/EU	Compliant
------------------------------	-----------

EU ELV Directive 2000/53/EC	Compliant
-----------------------------	-----------

China RoHS 2 Directive MIIT Order No 32, 2016	No Restricted Materials Above Threshold
---	---



EU REACH Regulation (EC) No. 1907/2006

Current ECHA Candidate List: JUNE 2023 (235)

Candidate List Declared Against: JAN 2023 (233)

Does not contain REACH SVHC

Halogen Content

BFR/CFR/PVC Free, but Br/Cl >900 ppm in other sources.

Solder Process Capability

Not applicable for solder process capability

Product Compliance Disclaimer

This information is provided based on reasonable inquiry of our suppliers and represents our current actual knowledge based on the information they provided. This information is subject to change. The part numbers that TE has identified as EU RoHS compliant have a maximum concentration of 0.1% by weight in homogenous materials for lead, hexavalent chromium, mercury, PBB, PBDE, DBP, BBP, DEHP, DIBP, and 0.01% for cadmium, or qualify for an exemption to these limits as defined in the Annexes of Directive 2011/65/EU (RoHS2). Finished electrical and electronic equipment products will be CE marked as required by Directive 2011/65/EU. Components may not be CE marked. Additionally, the part numbers that TE has identified as EU ELV compliant have a maximum concentration of 0.1% by weight in homogenous materials for lead, hexavalent chromium, and mercury, and 0.01% for cadmium, or qualify for an exemption to these limits as defined in the Annexes of Directive 2000/53/EC (ELV). Regarding the REACH Regulation, the information TE provides on SVHC in articles for this part number is based on the latest European Chemicals Agency (ECHA) 'Guidance on requirements for substances in articles' posted at this URL: <https://echa.europa.eu/guidance-documents/guidance-on-reach>

Compatible Parts

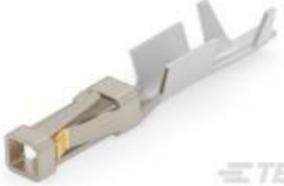

TE Part # 1-104479-0
SHORT POINT CONT 30 DPLX STMPD LF



TE Part # 104479-9
SHORT POINT CONT 15 DPLX STMPD LF



TE Part # 1-104480-7
SHORT POINT CONT PLTD SN



TE Part # 104480-4
SHORT POINT CONT 30 DPLX STMPD



TE Part # 1-104480-3
SHORT POINT CONT 30 DPLX STMPD LF



TE Part # 104479-8
SHORT POINT CONT PLTD SN



TE Part # 1-104480-2
SHORT POINT CONT 15 DPLX STMPD LF



TE Part # 104480-2
SHORT POINT CONT PLTD SN-PB

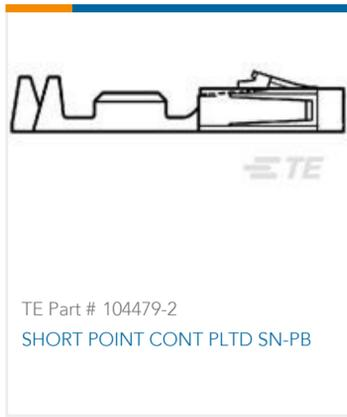

Also in the Series | AMPMODU IV/V

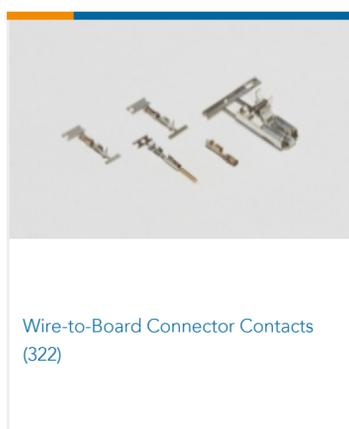
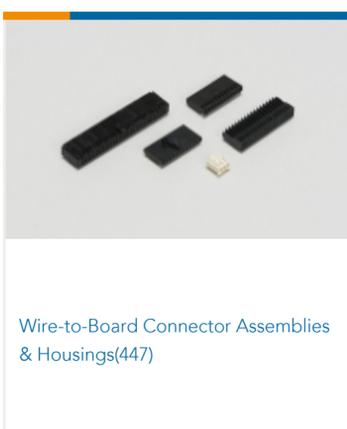
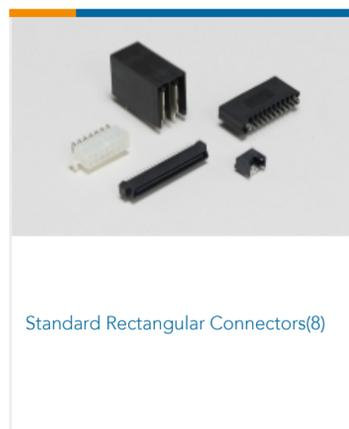
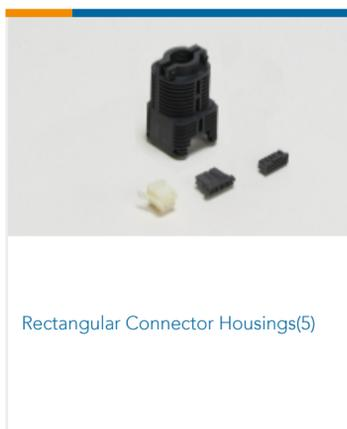
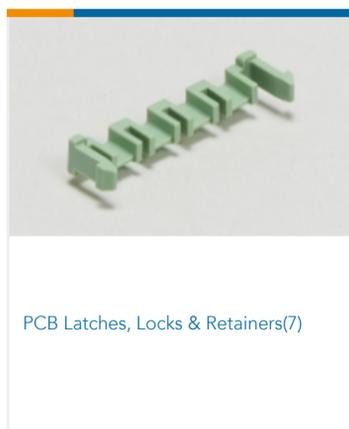
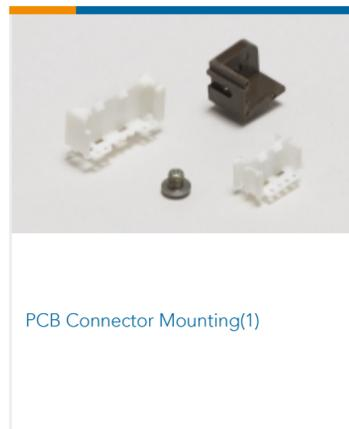
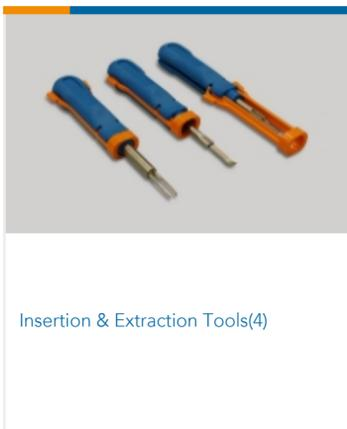
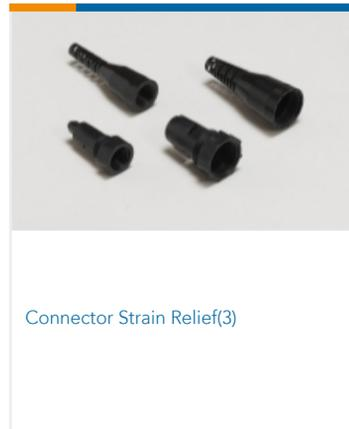
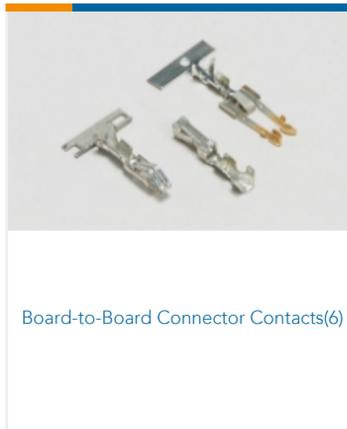
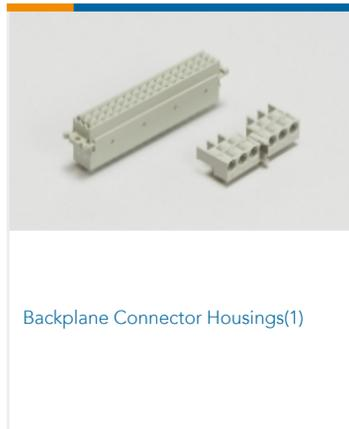
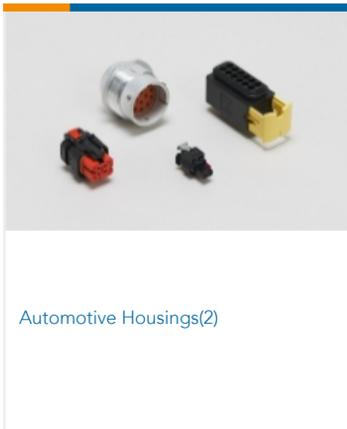

Customers Also Bought

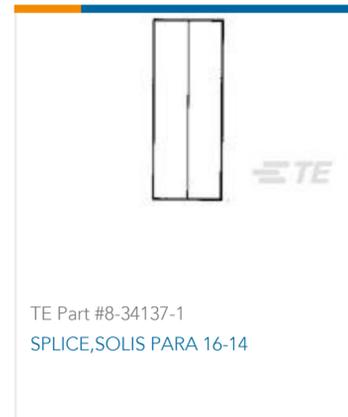

Documents

Product Drawings

[08 SHORT PT RCPT HSG DR .100CL](#)

English

CAD Files

[3D PDF](#)

3D

Customer View Model

[ENG_CVM_CVM_104483-1_K.2d_dxf.zip](#)

English

Customer View Model

[ENG_CVM_CVM_104483-1_K.3d_igs.zip](#)

English

Customer View Model

[ENG_CVM_CVM_104483-1_K.3d_stp.zip](#)

English

By downloading the CAD file I accept and agree to the [Terms and Conditions](#) of use.

Datasheets & Catalog Pages



AMPMODU_INTERCONNECTION_SYSTEM_SECTION5_CONT

English

Product Specifications

Application Specification

English

Agency Approvals

UL

English