

## Low Noise Amplifier 1.5 - 1.6 GHz

Rev. V1

### Features

- Low Noise Figure: 1.55 dB
- High Gain: 21 dB
- Low Power Consumption: 3 to 5 V, 8 mA
- High Dynamic Range
- DC Decoupled RF Input and Output
- No External RF Tuning Elements Necessary
- Lead-Free SOIC-8 Package
- 100% Matte Tin Plating over Copper
- Halogen-Free “Green” Mold Compound
- 260°C Reflow Compatible
- RoHS\* Compliant Version of MAAM12021

### Description

M/A-COM's MAALSS0044 is a high performance GaAs MMIC low noise amplifier in a lead-free SOIC-8 surface mount package. The MAALSS0044 employs a fully monolithic design which eliminates the need for external tuning networks. It can be biased using 3- or 5-volt supplies and has an option for biasing at higher currents for increased dynamic range.

The MAALSS0044 is ideally suited for use where low noise figure, high gain, high dynamic range and low power consumption are required. Typical applications include receiver front ends in the Global Positioning System (GPS) and Japanese Personal Digital Cellular (PDC-1500) markets, as well as standard gain blocks, buffer amps, driver amps and IF amps in both fixed and portable systems.

M/A-COM's MAALSS0044 is fabricated using a mature 0.5-micron gate length GaAs process. The process features full passivation for increased performance reliability.

### Ordering Information <sup>1,2</sup>

Part Number	Package
MAALSS0044	Bulk Packaging
MAALSS0044TR-3000	3000 piece reel
MAALSS0044SMB	Sample Test Board

1. Reference Application Note M513 for reel size information.
2. All sample boards include 5 loose parts.

### Functional Block Diagram

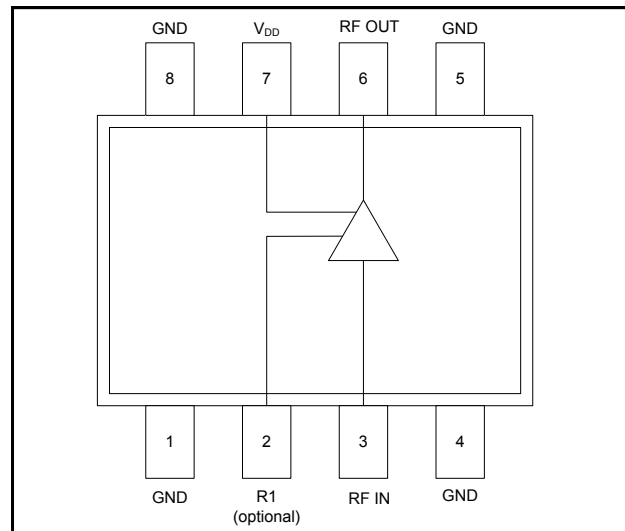

### Pin Configuration

Pin No.	Function	Pin No.	Function
1	Ground	5	Ground
2	R1 (Optional) See Note 10	6	RF Output
3	RF Input	7	V <sub>DD</sub>
4	Ground	8	Ground

### Absolute Maximum Ratings <sup>3,4</sup>

Parameter	Absolute Maximum
V <sub>DD</sub>	+10 VDC
Input Power	+17 dBm
Current <sup>5</sup>	30 mA
Channel Temperature <sup>6</sup>	+150°C
Operating Temperature	-40°C to +85°C
Storage Temperature	-65°C to +150°C

3. Exceeding any one or combination of these limits may cause permanent damage to this device.
4. M/A-COM does not recommend sustained operation near these survivability limits.
5. Only if pin 2 is used to increase current (see note 10).
6. Typical thermal resistance ( $\theta_{jc}$ ) = +165°C/W.

\* Restrictions on Hazardous Substances, European Union Directive 2002/95/EC.

## Low Noise Amplifier 1.5 - 1.6 GHz

Rev. V1

### Electrical Specifications <sup>7</sup>: $T_A = 25^\circ\text{C}$ , $V_{DD} = +5\text{ V}$ , $Z_0 = 50\ \Omega$

Parameter	Test Conditions	Units	Min.	Typ.	Max.
Gain	1.5 - 1.6 GHz, $P_{IN} = -30\text{ dBm}$	dB	19	21	23
Noise Figure	1.5 - 1.6 GHz	dB	—	1.55	1.9
Input VSWR	1.5 - 1.6 GHz, $P_{IN} = -30\text{ dBm}$	Ratio	—	1.5:1	—
Output VSWR	1.5 - 1.6 GHz, $P_{IN} = -30\text{ dBm}$	Ratio	—	1.5:1	—
Output 1 dB Compression	1.5 - 1.6 GHz	dBm	—	6	—
Input IP3	1.5 - 1.6 GHz, $P_{IN} = -30\text{ dBm}$	dBm	—	-2	—
Reverse Isolation	1.5 - 1.6 GHz, $P_{IN} = -30\text{ dBm}$	dB	—	40	—
Bias Current	—	mA	5	8	11

7. See plots for 3-volt performance.

### Recommended PCB Configuration

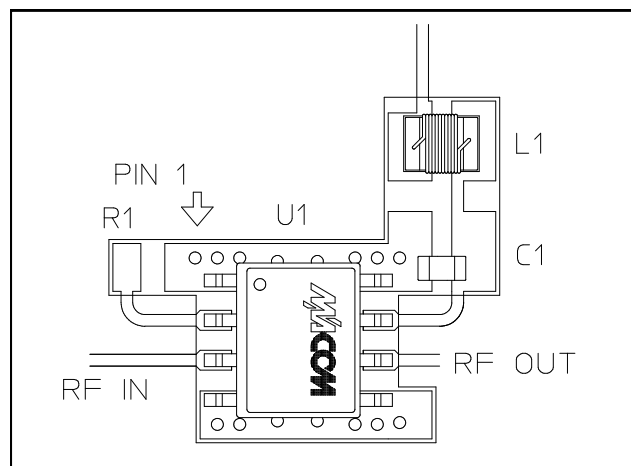

### Application Schematic <sup>8,9,10</sup>

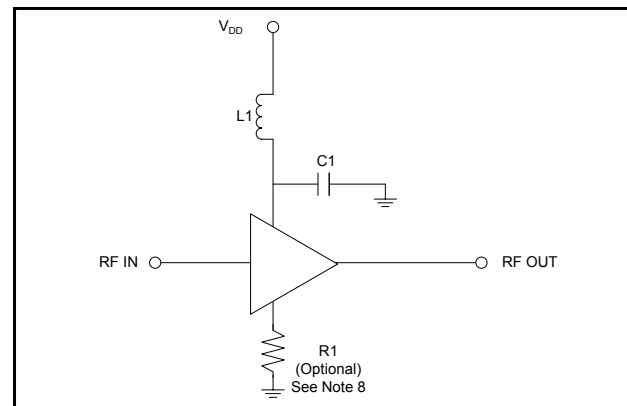

### Component List

Part	Value	Case Size	Manufacturer
C1	500 pF	0603	Murata
L1	15 nH	0805	Coilcraft
R1 (optional)	35 to 40 $\Omega$	0603	Panasonic

- Pins 1, 4, 5 and 8 must be RF and DC grounded as shown.
- Pin 3 is the RF input; pin 6 is the RF output.  $V_{DD}$  is applied on pin 7. This pin must be bypassed with a 500 pF surface mount MLC capacitor, mounted as close as possible to pin 7, and RF decoupled with a chip inductor having a minimum value of 15 nH (as shown in the Recommended PCB Configuration).
- Pin 2 allows use of an external resistor to ground for optional, higher current bias. For nominal current operation no resistor is used. For optional 20-mA current operation, connect a 35 to 40  $\Omega$  chip resistor (as shown in the Recommended PCB Configuration).

## Typical Performance Curves

**Gain @ +25°C**

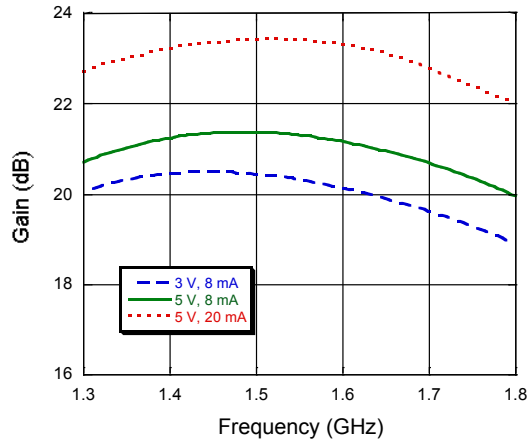

**Noise Figure @ +25°C**

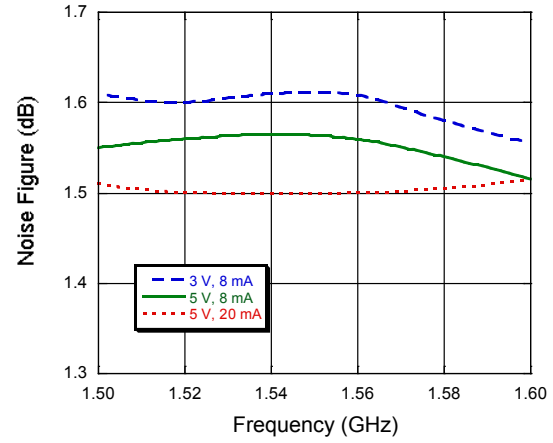

**VSWR @ 5 V, 8 mA, +25°C**

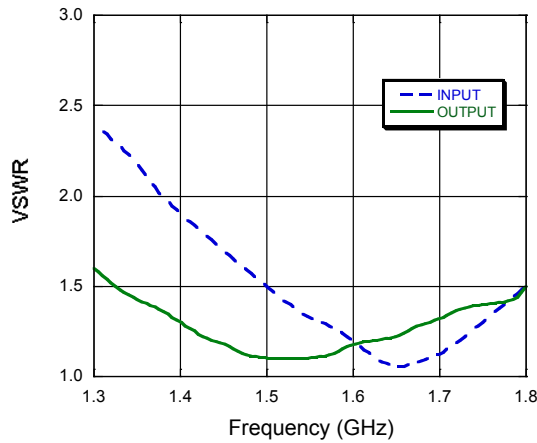

**Input IP3 @ +25°C**

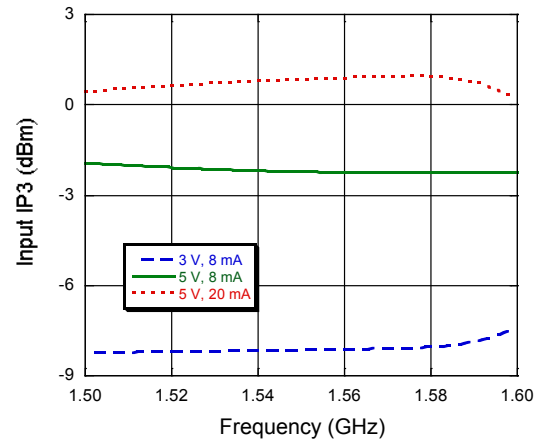

**Gain @ 5 V, 8 mA**

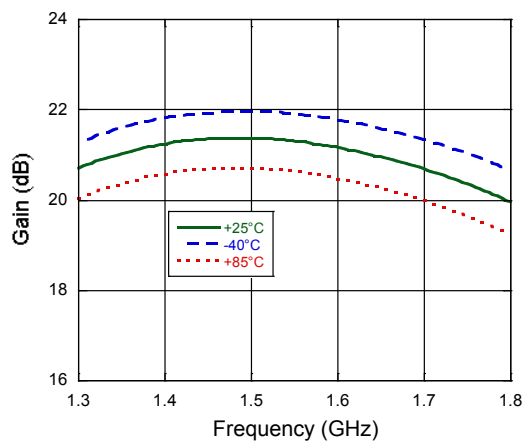

**Noise Figure @ 5 V, 8 mA**

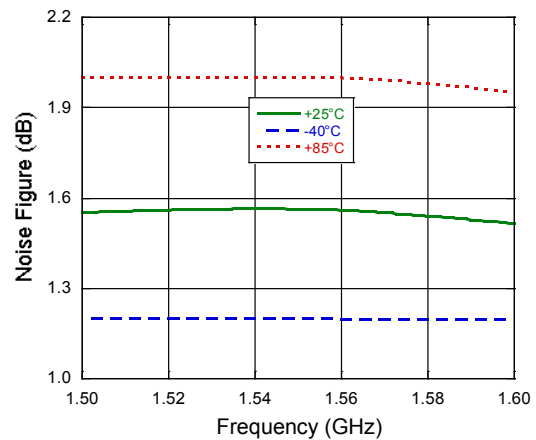

## Lead-Free SOIC-8†

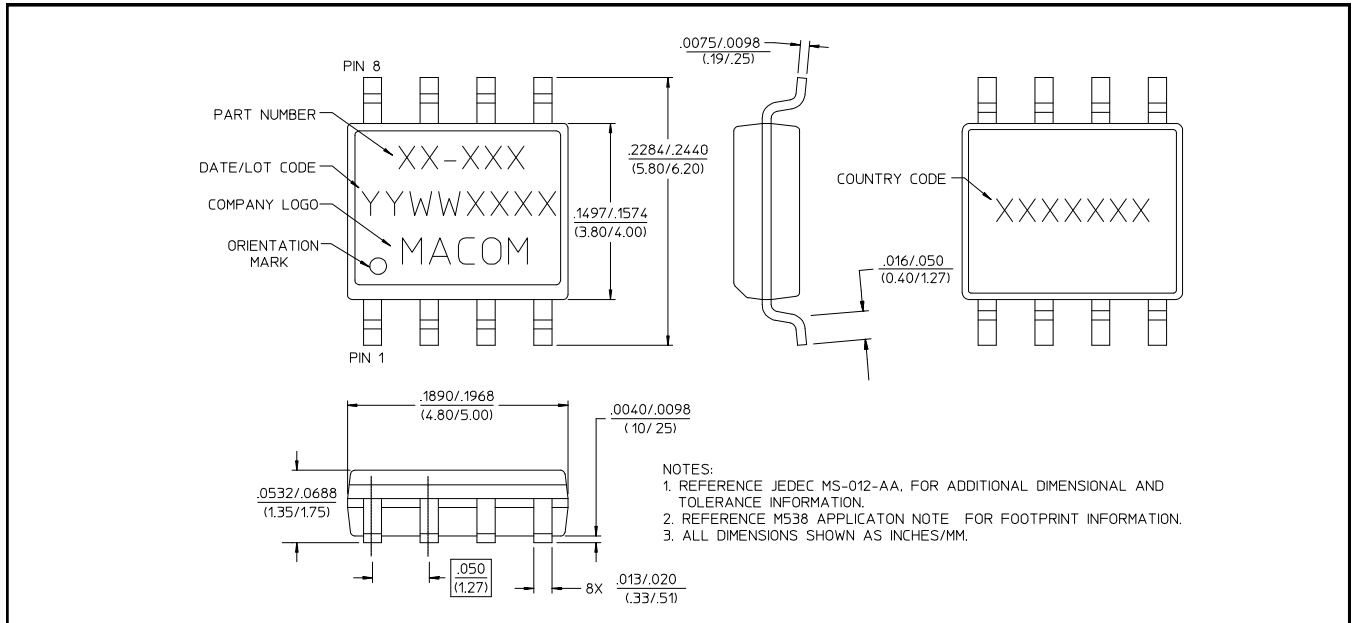

† Reference Application Note M538 for lead-free solder reflow recommendations.  
Additional information is available in Application Note M540, "M/A-COM GaAs MMIC LNA SOIC-8 Platform".  
Meets JEDEC moisture sensitivity level 1 requirements.

## Handling Procedures

Please observe the following precautions to avoid damage:

## Static Sensitivity

Gallium Arsenide Integrated Circuits are sensitive to electrostatic discharge (ESD) and can be damaged by static electricity. Proper ESD control techniques should be used when handling these devices.

M/A-COM Technology Solutions Inc. All rights reserved.

Information in this document is provided in connection with M/A-COM Technology Solutions Inc ("MACOM") products. These materials are provided by MACOM as a service to its customers and may be used for informational purposes only. Except as provided in MACOM's Terms and Conditions of Sale for such products or in any separate agreement related to this document, MACOM assumes no liability whatsoever. MACOM assumes no responsibility for errors or omissions in these materials. MACOM may make changes to specifications and product descriptions at any time, without notice. MACOM makes no commitment to update the information and shall have no responsibility whatsoever for conflicts or incompatibilities arising from future changes to its specifications and product descriptions. No license, express or implied, by estoppel or otherwise, to any intellectual property rights is granted by this document.

THESE MATERIALS ARE PROVIDED "AS IS" WITHOUT WARRANTY OF ANY KIND, EITHER EXPRESS OR IMPLIED, RELATING TO SALE AND/OR USE OF MACOM PRODUCTS INCLUDING LIABILITY OR WARRANTIES RELATING TO FITNESS FOR A PARTICULAR PURPOSE, CONSEQUENTIAL OR INCIDENTAL DAMAGES, MERCHANTABILITY, OR INFRINGEMENT OF ANY PATENT, COPYRIGHT OR OTHER INTELLECTUAL PROPERTY RIGHT. MACOM FURTHER DOES NOT WARRANT THE ACCURACY OR COMPLETENESS OF THE INFORMATION, TEXT, GRAPHICS OR OTHER ITEMS CONTAINED WITHIN THESE MATERIALS. MACOM SHALL NOT BE LIABLE FOR ANY SPECIAL, INDIRECT, INCIDENTAL, OR CONSEQUENTIAL DAMAGES, INCLUDING WITHOUT LIMITATION, LOST REVENUES OR LOST PROFITS, WHICH MAY RESULT FROM THE USE OF THESE MATERIALS.

MACOM products are not intended for use in medical, lifesaving or life sustaining applications. MACOM customers using or selling MACOM products for use in such applications do so at their own risk and agree to fully indemnify MACOM for any damages resulting from such improper use or sale.

5

---

*M/A-COM Technology Solutions Inc. (MACOM) and its affiliates reserve the right to make changes to the product(s) or information contained herein without notice.*  
Visit [www.macom.com](http://www.macom.com) for additional data sheets and product information.