

# MAX2091

## 50MHz to 500MHz Analog VGA, 1735MHz to 1935MHz Upconverting Mixer with Image Filtering, Threshold Alarm Circuit, and Error Amplifier for Level Control

### General Description

The MAX2091 monolithic SiGe BiCMOS upconverter IC integrates an analog variable-gain amplifier (VGA) with an upconverting mixer stage and image filter. The device amplifies IF signals in the 250MHz to 450MHz range before mixing them with an LO signal. The resulting 1735MHz to 1935MHz upconverted signal is then filtered on-chip as the final stage of signal conditioning. For a broadband variant that does not include the image filter, refer to the MAX2091B.

The analog attenuator is controlled by an external analog control voltage. Device features include 23dB gain (no attenuation), 5.4dB NF (no attenuation, including attenuator insertion loss), and +24.5dBm OIP3. Each of these features makes the MAX2091 an ideal upconverter for numerous transmitter applications. When paired with the MAX2092 RF VGA, a complete 2-chip IF-RF signal conditioning solution is possible for microwave point-to-point transmitter applications.

The MAX2091 operates from a single 5V supply, and is available in a compact 20-pin TQFN package (5mm x 5mm) with an exposed pad. Electrical performance is guaranteed over the extended temperature range from  $T_C = -40^{\circ}\text{C}$  to  $+95^{\circ}\text{C}$ .

### Applications

Microwave Point-to-Point Transmitters  
IF Variable-Gain Stages  
Temperature Compensation Circuits  
Cellular Applications  
WiMAX® Applications  
LTE Applications  
Fixed Broadband Wireless Access  
Wireless Local Loop

### Benefits and Features

- ◆ Complete Upconversion in a Single IC
  - ◇ 50MHz to 500MHz Analog VGA
  - ◇ 1735MHz to 1935MHz Upconverter Mixer
  - ◇ On-Chip LO Buffer
  - ◇ Image Filter
- ◆ High Linearity
  - ◇ +24.5dBm OIP3
  - ◇ +12dBm Output -1dB Compression Point
- ◆ 23dB Gain
- ◆ 37dB IF Attenuator Control Range
- ◆ 5.4dB Noise Figure (Includes Attenuator Insertion Loss)
- ◆ 0.25dB Gain Variation Over 100MHz Bandwidth
- ◆ Analog Attenuator Controlled with External Voltage
- ◆ Alarm Circuit with Adjustable Threshold
- ◆ 20dB Image Rejection at 1135MHz RF Frequency
- ◆ Single +5V Supply with Extended +4.75V to +5.8V Supply Range
- ◆ Lead(Pb)-Free Package
- ◆ Power-Down Capabilities

[Ordering Information](#) appears at end of data sheet.

For related parts and recommended products to use with this part, refer to [www.maximintegrated.com/MAX2091.related](http://www.maximintegrated.com/MAX2091.related).

WiMAX is a registered certification mark and registered service mark of WiMAX Forum.

For pricing, delivery, and ordering information, please contact Maxim Direct at 1-888-629-4642, or visit Maxim's website at [www.maximintegrated.com](http://www.maximintegrated.com).

# MAX2091

## 50MHz to 500MHz Analog VGA, 1735MHz to 1935MHz Upconverting Mixer with Image Filtering, Threshold Alarm Circuit, and Error Amplifier for Level Control

### ABSOLUTE MAXIMUM RATINGS

V<sub>CC\_A</sub>, V<sub>CC\_IF</sub>, V<sub>CC\_LO</sub>, V<sub>CC\_RF</sub>.....-0.3V to +6V  
 IF\_IN, MIX\_IN, IF\_OUT, LO+, RF\_OUT .....-0.3V to V<sub>CC</sub> + 0.3V  
 ALM, R\_BIAS, DET\_VIN, AMP\_OUT, LO- .....-0.3V to +3.6V  
 ALM\_THRES, PLVLSET,  
 CTRL1, CTRL2.....-0.3V to MINIMUM (V<sub>CC</sub> + 0.3V, +3.6V)  
 IF\_IN, MIX\_IN Input Power ..... +15dBm  
 Continuous Power Dissipation (Note 1).....2.5W

Operating Case Temperature  
 Range (Note 2).....-40°C to +95°C  
 Maximum Junction Temperature..... 150°C  
 Storage Temperature Range.....-65°C to +150°C  
 Lead Temperature (soldering 10s) ..... 300°C  
 Soldering Temperature (reflow) .....+260°C

*Stresses beyond those listed under "Absolute Maximum Ratings" may cause permanent damage to the device. These are stress ratings only, and functional operation of the device at these or any other conditions beyond those indicated in the operational sections of the specifications is not implied. Exposure to absolute maximum rating conditions for extended periods may affect device reliability.*

### PACKAGE THERMAL CHARACTERISTICS

QSOP

Junction-to-Ambient Thermal Resistance (θ<sub>JA</sub>).... +103.7°C/W  
 Junction-to-Case Thermal Resistance (θ<sub>JC</sub>)..... +37°C/W

QSOP-EP

Junction-to-Ambient Thermal Resistance (θ<sub>JA</sub>)..... +44°C/W  
 Junction-to-Case Thermal Resistance (θ<sub>JC</sub>)..... +6°C/W

- Note 1:** Based on junction temperature  $T_J = T_C + (\theta_{JC} \times V_{CC} \times I_{CC})$ . This formula can be used when the temperature of the exposed pad is known while the device is soldered down to a PCB. See the [Applications Information](#) section for details. The junction temperature must not exceed +150°C.
- Note 2:** T<sub>C</sub> is the temperature on the exposed pad of the package. T<sub>A</sub> is the ambient temperature of the device and PCB.
- Note 3:** Junction temperature  $T_J = T_A + (\theta_{JA} \times V_{CC} \times I_{CC})$ . This formula can be used when the ambient temperature of the PCB is known. The junction temperature must not exceed +150°C.
- Note 4:** Package thermal resistances were obtained using the method described in JEDEC specification JESD51-7, using a four-layer board. For detailed information on package thermal considerations, refer to [www.maximintegrated.com/thermal-tutorial](http://www.maximintegrated.com/thermal-tutorial).

### DC ELECTRICAL CHARACTERISTICS

(*Typical Application Circuit*, V<sub>CC</sub> = 4.75V to 5.8V, V<sub>GND</sub> = 0V, P<sub>LO</sub> = -10dBm to -4dBm, and T<sub>C</sub> = -40°C to +95°C. Typical values are at V<sub>CC</sub> = 5.5V, P<sub>LO</sub> = -7dBm, and T<sub>C</sub> = +25°C, unless otherwise noted.) (Note 5)

PARAMETER	SYMBOL	CONDITIONS	MIN	TYP	MAX	UNITS
Supply Voltage	V <sub>CC</sub>		4.75	5.5	5.8	V
Total Supply Current	I <sub>DC</sub>	CTRL1 = 1, CTRL2 = 1		264	290	mA
		CTRL1 = 1, CTRL2 = 0		254		
		CTRL1 = 0, CTRL2 = 0		8.5	15	
CTRL1/CTRL2 Logic-Low Input Voltage	V <sub>IL</sub>				0.8	V
CTRL1/CTRL2 Logic-High Input Voltage	V <sub>IH</sub>		2.2			V
CTRL1/CTRL2 Input Logic Current	I <sub>IH</sub> /I <sub>IL</sub>		-10		10	μA
PLVLSET Input Resistance	R <sub>IN</sub>		650			kΩ
PLVLSET Input Voltage Range			0		2.5	V
PLVLSET Minimum Control Voltage			0	0.1	0.2	V
PLVLSET Maximum Control Voltage			2.3	2.4	2.5	V
DET_IN Input Voltage Range	V <sub>IN</sub>		0		2.5	V
ALM_THRES Input Resistance			90	135		kΩ
Alarm Output Logic 1			3.135	3.3	3.465	V
Alarm Output Logic 0					0.4	V
DET_VIN Input Resistance			175	235	295	kΩ

# MAX2091

## 50MHz to 500MHz Analog VGA, 1735MHz to 1935MHz Upconverting Mixer with Image Filtering, Threshold Alarm Circuit, and Error Amplifier for Level Control

### RECOMMENDED AC OPERATING CONDITIONS

PARAMETER	SYMBOL	CONDITIONS	MIN	TYP	MAX	UNIT
RF Frequency	$f_{RF}$	(Note 6)	1685		1985	MHz
LO Frequency	$f_{LO}$	(Note 6)	1185	1485	2485	MHz
IF_IN Frequency	$f_{IF\_IN}$	(Note 6)	50		500	MHz
MIX_IN Frequency	$f_{MIX\_IN}$	(Note 6)	100		500	MHz
LO Power	$P_{LO}$		-10		-4	dBm

### AC ELECTRICAL CHARACTERISTICS

*(Typical Application Circuit* with analog attenuator set to maximum gain,  $V_{CC} = 4.75V$  to  $5.8V$ ,  $f_{RF} = 1835MHz$ ,  $f_{LO} = 1485MHz$ ,  $f_{IF} = 350MHz$ ,  $f_{RF} = f_{LO} + f_{IF}$ ,  $P_{LO} = -10dBm$  to  $-4dBm$ ,  $T_C = -40^{\circ}C$  to  $+95^{\circ}C$ , and IF\_IN, LO+, and RF\_OUT ports are connected to  $50\Omega$  sources and loads, unless otherwise noted. Typical values are at  $T_C = +25^{\circ}C$ ,  $V_{CC} = 5.5V$ ,  $P_{LO} = -7dBm$ ,  $P_{IF} = -25dBm$ ,  $V_{PLVLSET} = 2.5V$ , CTRL1 = logic 1, CTRL2 = logic 0. Min/max specifications apply over supply, process, and temperature, unless otherwise noted. (Notes 5, 7, 8)

PARAMETER	SYMBOL	CONDITIONS	MIN	TYP	MAX	UNITS
<b>VGA + 2.5dB PAD + MIXER CASCADE</b>						
Small-Signal Gain	G		20	23	26	dB
Gain vs. Temperature				-0.016		dB/C
Gain Variation vs. Frequency (Note 9)		1835MHz $\pm$ 50MHz		0.25		dB
		1835MHz $\pm$ 80MHz		0.4		
		1835MHz $\pm$ 100MHz		0.6		
Noise Figure	NF			5.4		dB
Total Attenuation Range		$V_{PLVLSET} = 0.2V$ to $2.5V$	35	37		dB
Group-Delay Variation		Within $\pm 50MHz$		133		ps
		Within $\pm 80MHz$		220		
		Within $\pm 100MHz$		285		
Spurious Response		LO + 2IF, $P_{RF\_OUT} = -2dBm$		60		dBc
		LO - 2IF, $P_{RF\_OUT} = -2dBm$		70		
		LO + 3IF, $P_{RF\_OUT} = -2dBm$		67		
		LO - 3IF, $P_{RF\_OUT} = -2dBm$		77		
Output Third-Order Intercept Point	OIP3	$P_{RF\_OUT} = -2dBm/$ tone, $f_{RF2} - f_{RF1} = 1MHz$		24.5		dBm
Output -1dB Compression Point	$P_{1dB}$			12		dBm
LO Leakage at IF_IN				-60		dBm
IF_IN Return Loss				21		dB
		$f_{IF} = 140MHz$		17.5		
LO+ Port Return Loss				24		dB
RF_OUT Return Loss				19.6		dB

# MAX2091

## 50MHz to 500MHz Analog VGA, 1735MHz to 1935MHz Upconverting Mixer with Image Filtering, Threshold Alarm Circuit, and Error Amplifier for Level Control

### AC ELECTRICAL CHARACTERISTICS (continued)

([Typical Application Circuit](#) with analog attenuator set to maximum gain,  $V_{CC} = 4.75V$  to  $5.8V$ ,  $f_{RF} = 1835MHz$ ,  $f_{LO} = 1485MHz$ ,  $f_{IF} = 350MHz$ ,  $f_{RF} = f_{LO} + f_{IF}$ ,  $P_{LO} = -10dBm$  to  $-4dBm$ ,  $T_C = -40^{\circ}C$  to  $+95^{\circ}C$ , and  $IF\_IN$ ,  $LO+$ , and  $RF\_OUT$  ports are connected to  $50\Omega$  sources and loads, unless otherwise noted. Typical values are at  $T_C = +25^{\circ}C$ ,  $V_{CC} = 5.5V$ ,  $P_{LO} = -7dBm$ ,  $P_{IF} = -25dBm$ ,  $V_{PLVLSET} = 2.5V$ ,  $CTRL1 = \text{logic } 1$ ,  $CTRL2 = \text{logic } 0$ . Min/max specifications apply over supply, process, and temperature, unless otherwise noted. (Notes 5, 7, 8)

PARAMETER	SYMBOL	CONDITIONS	MIN	TYP	MAX	UNITS
<b>IF VGA (ATTENUATOR + AMPLIFIER)</b>						
Small-Signal Gain			23.5	26	27.5	dB
Noise Figure				4.0		dB
Output Third-Order Intercept Point	OIP3	Up to 30dB attenuation, $P_{IF\_OUT} = 0dBm/$ tone, $f_{RF2} - f_{RF1} = 1MHz$		38.8		dBm
Output Second-Order Intercept Point	OIP2	$P_{IF\_OUT} = 0dBm/$ tone, $f_{RF2} - f_{RF1} = 1MHz$		57.4		dBm
Output Second Harmonic		$P_{IF\_OUT} = 0dBm$		64.5		dBc
Output Third Harmonic		$P_{IF\_OUT} = 0dBm$		80.0		dBc
Output -1dB Compression Point	$P_{1dB}$			17.6		dBm
Average Gain-Control Slope		$V_{PLVLSET} = 0.5V$ to $2.0V$	16.5	19.5	23.0	dB/V
Maximum Gain-Control Slope		$V_{PLVLSET} = 0V$ to $2.5V$		25		dB/V
VGA Reverse Isolation				35		dB
Attenuator Response Time		$P_{IF\_IN} = -15dBm$ , $V_{PLVLSET} = 2.5V$ to $1.2V$ , output settled to within $\pm 0.5dB$ of final value		330		ns
		$P_{IF\_IN} = -15dBm$ , $V_{PLVLSET} = 1.2V$ to $2.5V$ , output settled to within $\pm 0.5dB$ of final value		220		
Insertion Phase Change		$V_{PLVLSET} = 2.5V$ to $0V$		11.4		Degrees
<b>MIXER WITH IMAGE REJECT FILTER</b>						
Conversion Gain	G		-2.2	-0.5	1.5	dB
SSB Noise Figure	NF			17.1		dB
Output Third-Order Intercept Point	OIP3			24.7		dBm
Output -1dB Compression Point	$P_{1dB}$			12.2		dBm
Image Rejection		$f_{IF} = 350MHz \pm 50MHz$	15	20		dB
LO Leakage at $RF\_OUT$				-41		dBm
2LO Leakage at $RF\_OUT$				-35		dBm
Second Harmonic	HD2	$P_{RF\_OUT} = -2dBm$		65		dBc
Third Harmonic	HD3	$P_{RF\_OUT} = -2dBm$		77.5		dBc
3LO + IF Spur		$P_{RF\_OUT} = -2dBm$		33		dBc
MIX_IN Return Loss				22		dB
LO+ Port Return Loss				24		dB
RF_OUT Return Loss				20		dB

# MAX2091

## 50MHz to 500MHz Analog VGA, 1735MHz to 1935MHz Upconverting Mixer with Image Filtering, Threshold Alarm Circuit, and Error Amplifier for Level Control

### AC ELECTRICAL CHARACTERISTICS (continued)

([Typical Application Circuit](#) with analog attenuator set to maximum gain,  $V_{CC} = 4.75V$  to  $5.8V$ ,  $f_{RF} = 1835MHz$ ,  $f_{LO} = 1485MHz$ ,  $f_{IF} = 350MHz$ ,  $f_{RF} = f_{LO} + f_{IF}$ ,  $P_{LO} = -10dBm$  to  $-4dBm$ ,  $T_C = -40^{\circ}C$  to  $+95^{\circ}C$ , and IF\_IN, LO+, and RF\_OUT ports are connected to  $50\Omega$  sources and loads, unless otherwise noted. Typical values are at  $T_C = +25^{\circ}C$ ,  $V_{CC} = 5.5V$ ,  $P_{LO} = -7dBm$ ,  $P_{IF} = -25dBm$ ,  $V_{PLVSET} = 2.5V$ , CTRL1 = logic 1, CTRL2 = logic 0. Min/max specifications apply over supply, process, and temperature, unless otherwise noted. (Notes 5, 7, 8)

PARAMETER	SYMBOL	CONDITIONS	MIN	TYP	MAX	UNITS
<b>ERROR AMPLIFIER AND ALARM CIRCUIT (CTRL1 = CTRL2 = LOGIC 1)</b>						
Maximum AMP_OUT Capacitance to GND		(Note 6)			20	pF
ALM Threshold		Input = DET_VIN		1.35		V

- Note 5:** Min and max limits are production tested, and guaranteed at  $T_C = +95^{\circ}C$  for worst-case supply voltage and frequency.
- Note 6:** Recommended functional range, not production tested. Operation outside this range is possible, but with degraded performance of some parameters.
- Note 7:** All limits include external component and PCB losses. Output measurements taken at the RF port of the [Typical Application Circuit](#).
- Note 8:** It is advisable not to continuously operate the VGA IF\_IN and MIX\_IN above  $+11dBm$ .
- Note 9:** Gain variation after slope compensation with external equalizer in position R2–R4 in the [Typical Application Circuit](#).

### Typical Operating Characteristics

([Typical Application Circuit](#) configured for AGC amp only (IF\_IN to IF\_OUT), analog attenuator set to maximum gain ( $V_{PLVSET} = 2.5V$ ),  $V_{CC} = 5.5V$ ,  $T_C = +25^{\circ}C$ ,  $f_{IF\_IN} = 350MHz$ ,  $P_{IF\_IN} = -25dBm$ ,  $R_{SOURCE} = R_{LOAD} = 50\Omega$ , CTRL1 = 1, CTRL2 = 0, ALM\_THRES = ALM = open, unless otherwise noted.)

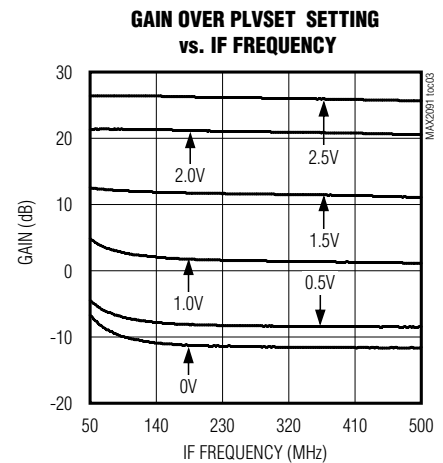
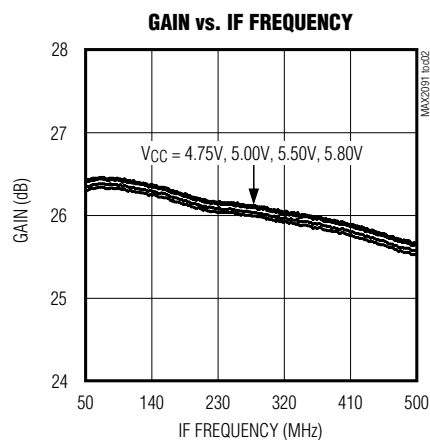
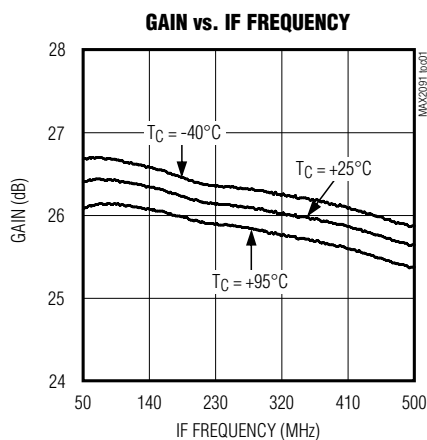

# MAX2091

## 50MHz to 500MHz Analog VGA, 1735MHz to 1935MHz Upconverting Mixer with Image Filtering, Threshold Alarm Circuit, and Error Amplifier for Level Control

### Typical Operating Characteristics (continued)

(Typical Application Circuit configured for AGC amp only (IF\_IN to IF\_OUT), analog attenuator set to maximum gain ( $V_{PLVSET} = 2.5V$ ),  $V_{CC} = 5.5V$ ,  $T_C = +25^\circ C$ ,  $f_{IF\_IN} = 350MHz$ ,  $P_{IF\_IN} = -25dBm$ ,  $R_{SOURCE} = R_{LOAD} = 50\Omega$ ,  $CTRL1 = 1$ ,  $CTRL2 = 0$ ,  $ALM\_THRES = ALM =$  open, unless otherwise noted.)

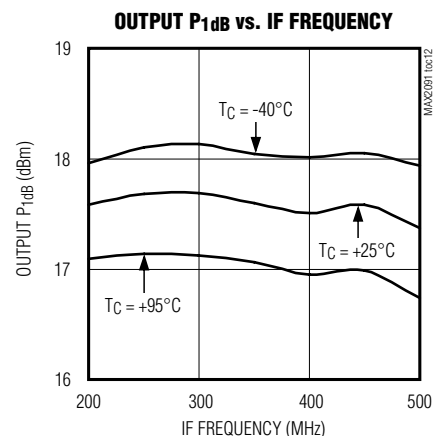
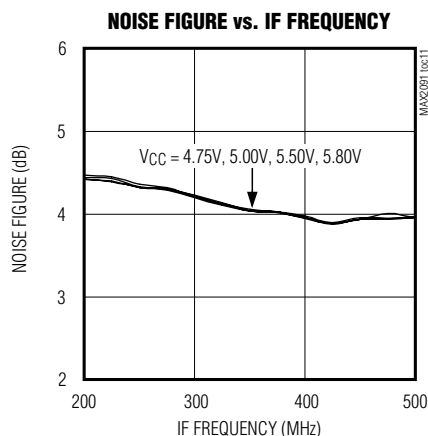
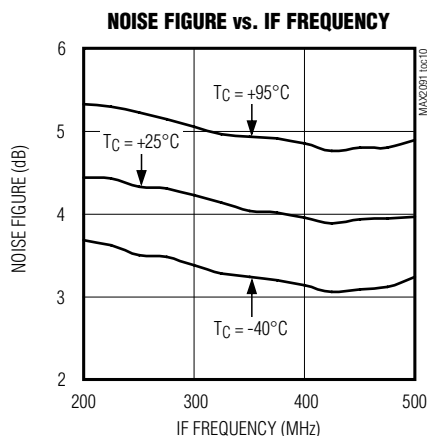
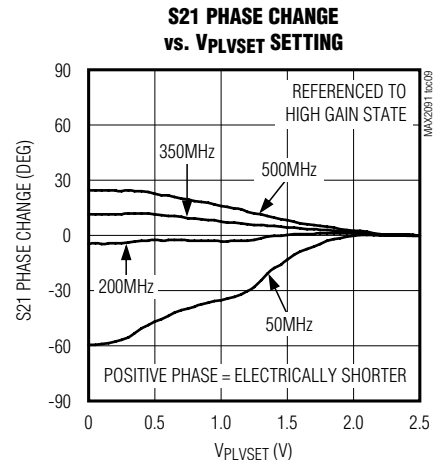
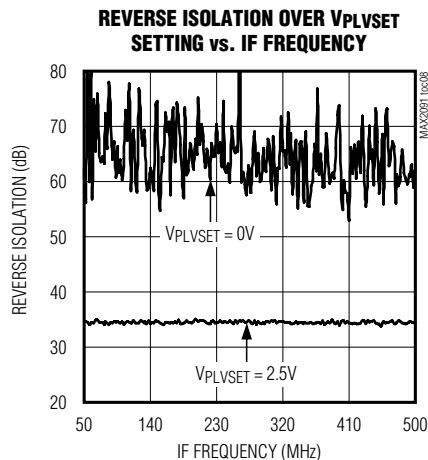
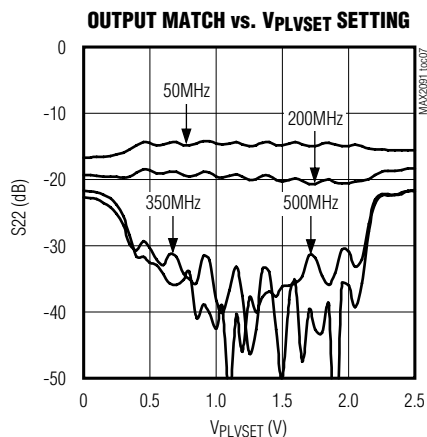
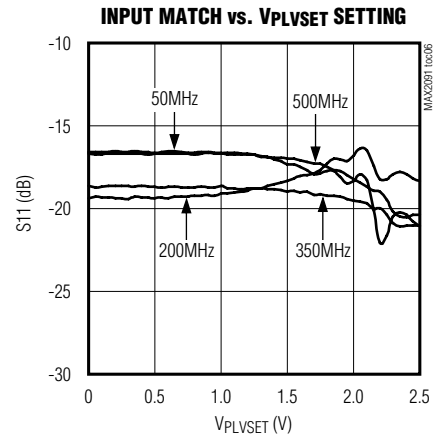
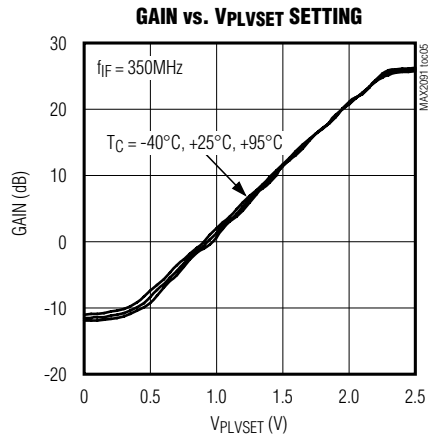
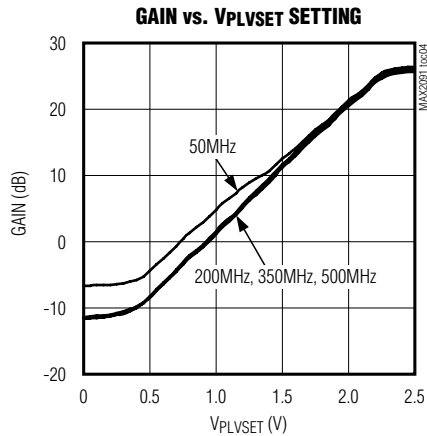

# MAX2091

## 50MHz to 500MHz Analog VGA, 1735MHz to 1935MHz Upconverting Mixer with Image Filtering, Threshold Alarm Circuit, and Error Amplifier for Level Control

### Typical Operating Characteristics (continued)

(Typical Application Circuit configured for AGC amp only (IF\_IN to IF\_OUT), analog attenuator set to maximum gain ( $V_{PLVSET} = 2.5V$ ),  $V_{CC} = 5.5V$ ,  $T_C = +25^\circ C$ ,  $f_{IF\_IN} = 350MHz$ ,  $P_{IF\_IN} = -25dBm$ ,  $R_{SOURCE} = R_{LOAD} = 50\Omega$ ,  $CTRL1 = 1$ ,  $CTRL2 = 0$ ,  $ALM\_THRES = ALM =$  open, unless otherwise noted.)

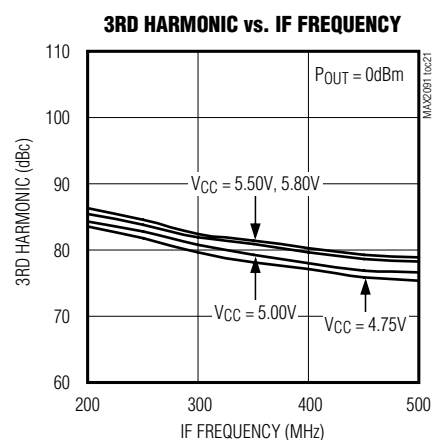
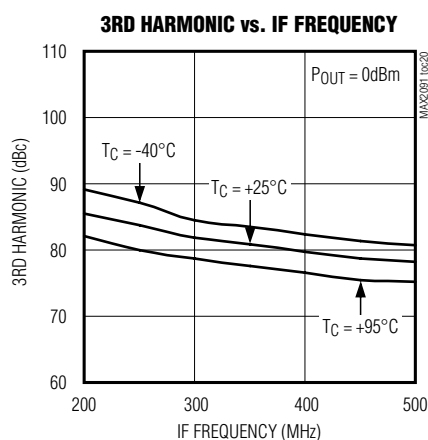
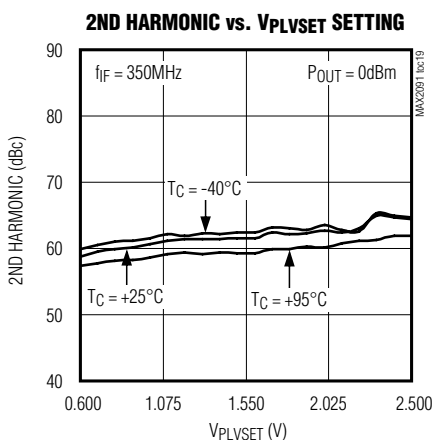
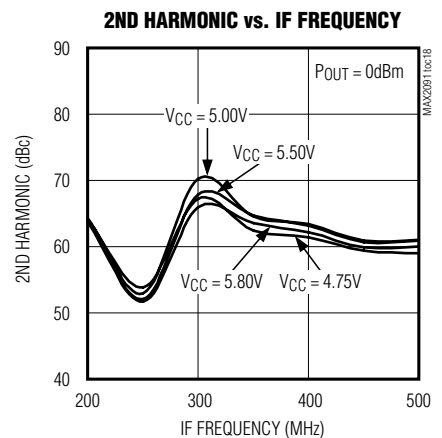
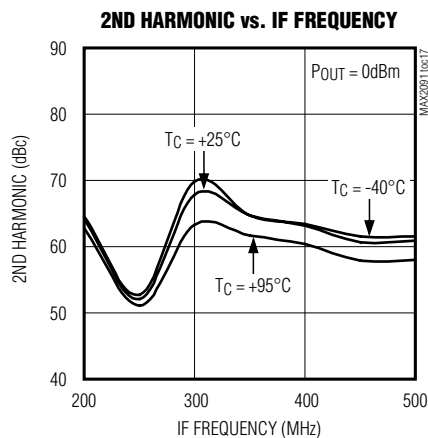
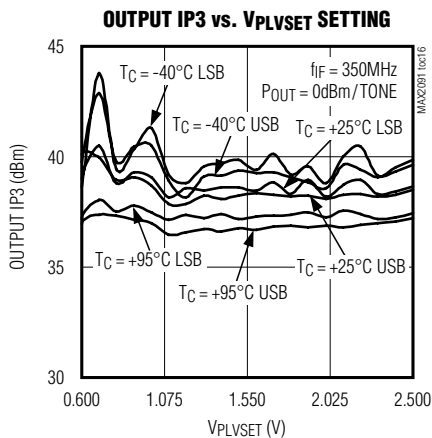
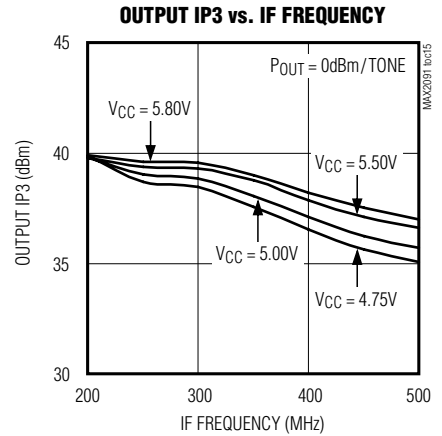
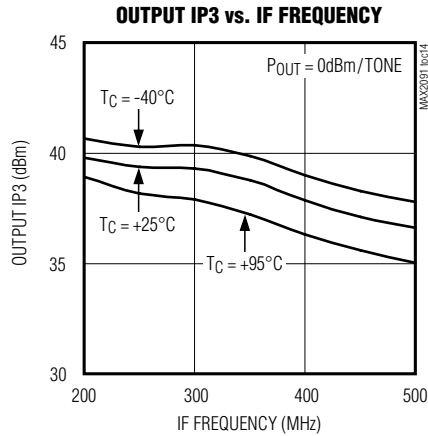
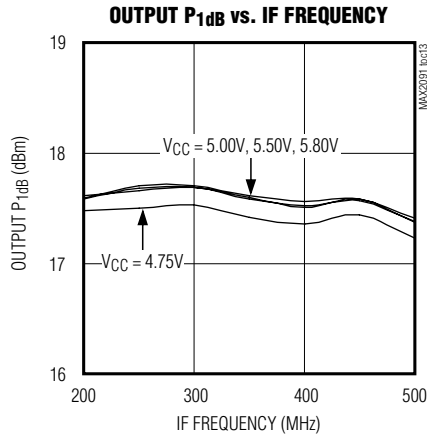

# MAX2091

## 50MHz to 500MHz Analog VGA, 1735MHz to 1935MHz Upconverting Mixer with Image Filtering, Threshold Alarm Circuit, and Error Amplifier for Level Control

### Typical Operating Characteristics (continued)

(Typical Application Circuit configured for AGC amp only (IF\_IN to IF\_OUT), analog attenuator set to maximum gain ( $V_{PLVSET} = 2.5V$ ),  $V_{CC} = 5.5V$ ,  $T_C = +25^\circ C$ ,  $f_{IF\_IN} = 350MHz$ ,  $P_{IF\_IN} = -25dBm$ ,  $R_{SOURCE} = R_{LOAD} = 50\Omega$ ,  $CTRL1 = 1$ ,  $CTRL2 = 0$ ,  $ALM\_THRES = ALM =$  open, unless otherwise noted.)

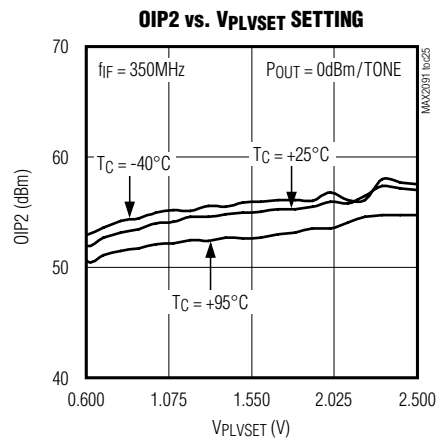
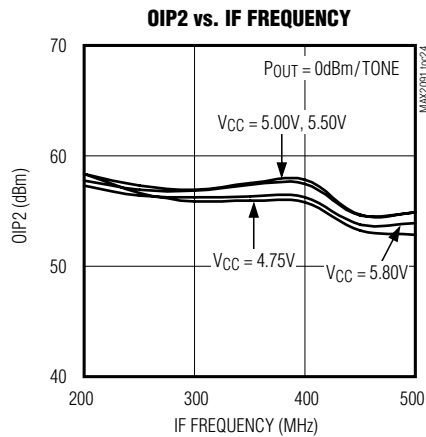
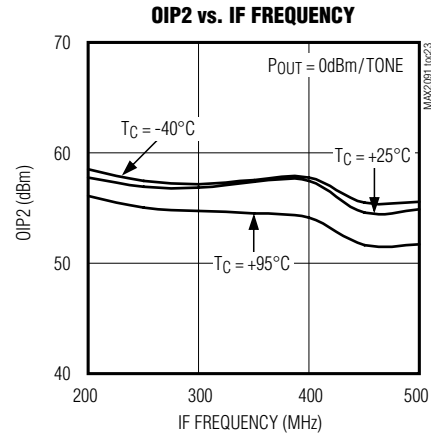
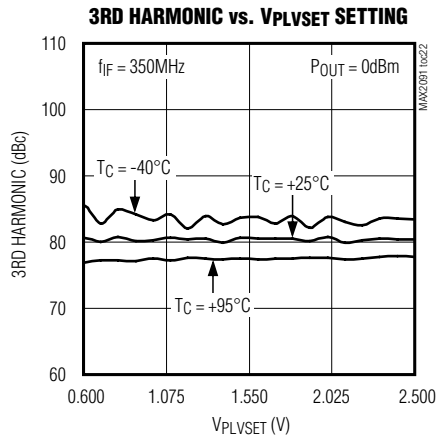



# MAX2091

## 50MHz to 500MHz Analog VGA, 1735MHz to 1935MHz Upconverting Mixer with Image Filtering, Threshold Alarm Circuit, and Error Amplifier for Level Control

### Typical Operating Characteristics (continued)

(Typical Application Circuit configured for Mixer only (MIX\_IN to RF\_OUT),  $V_{CC} = 5.5V$ ,  $T_C = +25^\circ C$ ,  $f_{MIX\_IN} = 350MHz$ ,  $P_{MIX\_IN} = -1dBm$ ,  $f_{LO} = 1485MHz$ ,  $P_{LO} = -7dBm$ ,  $f_{RF} = f_{IF\_IN} + f_{LO}$ ,  $R_{SOURCE} = R_{LOAD} = 50\Omega$ ,  $CTRL1 = 1$ ,  $CTRL2 = 0$ ,  $ALM\_THRES = ALM = open$ , unless otherwise noted.)

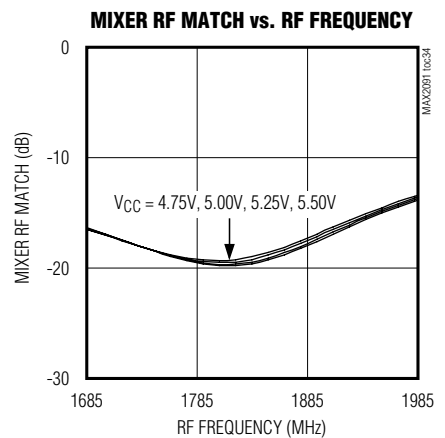
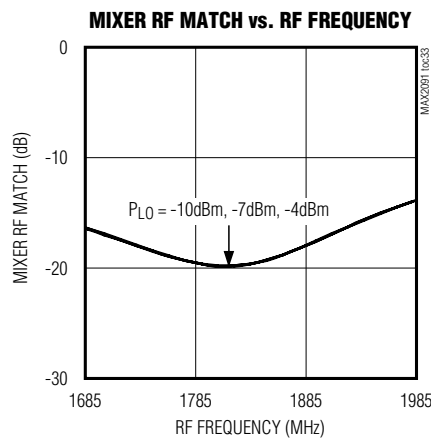
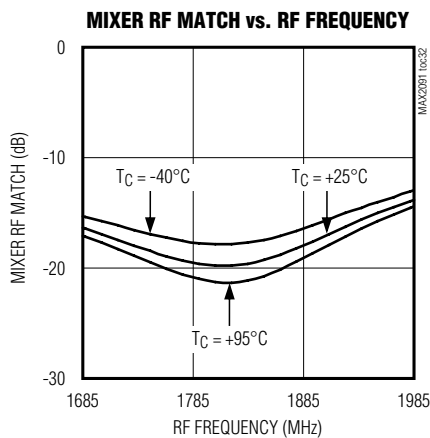
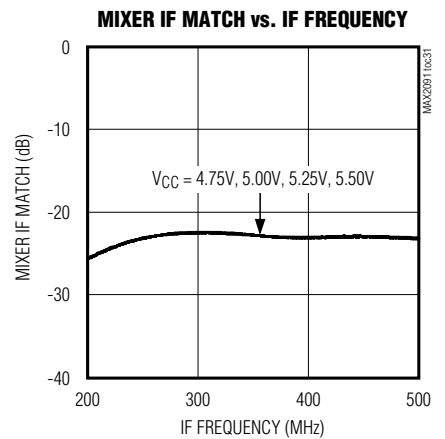
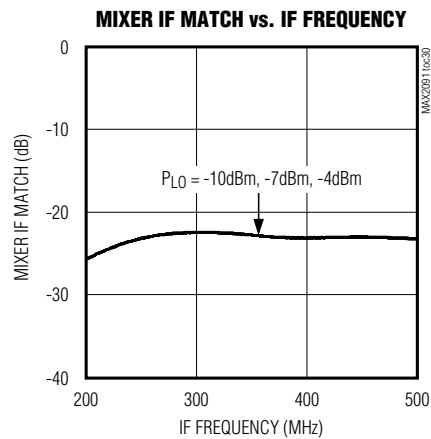
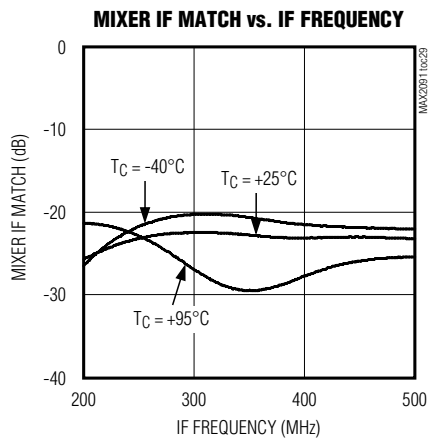
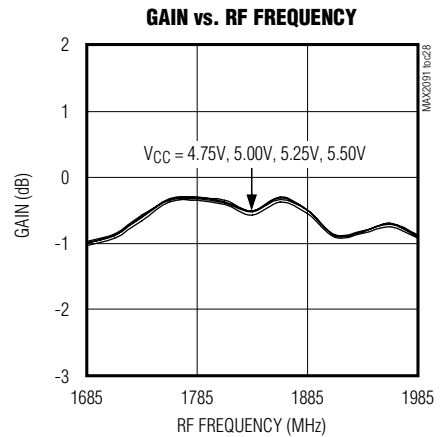
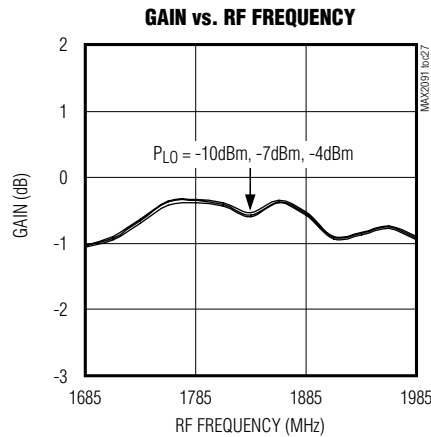
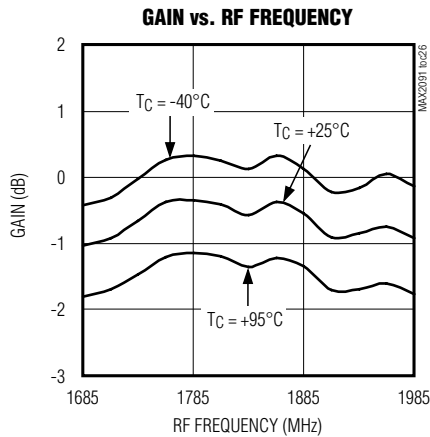

# MAX2091

## 50MHz to 500MHz Analog VGA, 1735MHz to 1935MHz Upconverting Mixer with Image Filtering, Threshold Alarm Circuit, and Error Amplifier for Level Control

### Typical Operating Characteristics (continued)

(Typical Application Circuit configured for Mixer only (MIX\_IN to RF\_OUT),  $V_{CC} = 5.5V$ ,  $T_C = +25^\circ C$ ,  $f_{MIX\_IN} = 350MHz$ ,  $P_{MIX\_IN} = -1dBm$ ,  $f_{LO} = 1485MHz$ ,  $P_{LO} = -7dBm$ ,  $f_{RF} = f_{IF\_IN} + f_{LO}$ ,  $R_{SOURCE} = R_{LOAD} = 50\Omega$ ,  $CTRL1 = 1$ ,  $CTRL2 = 0$ ,  $ALM\_THRES = ALM = open$ , unless otherwise noted.)

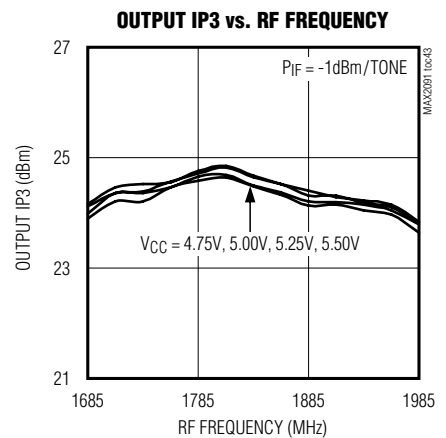
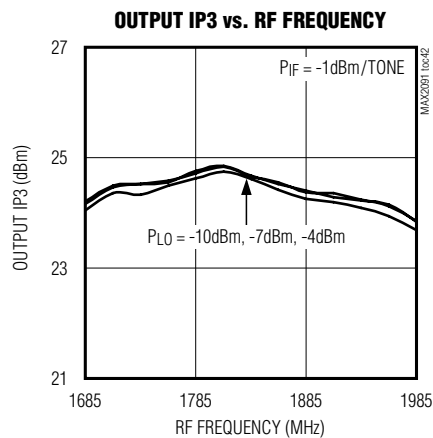
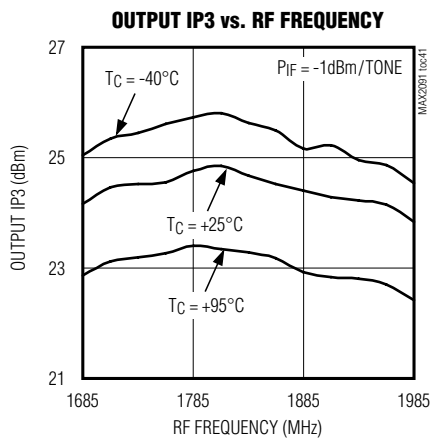
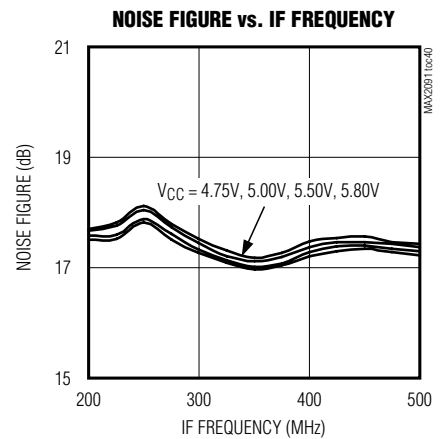
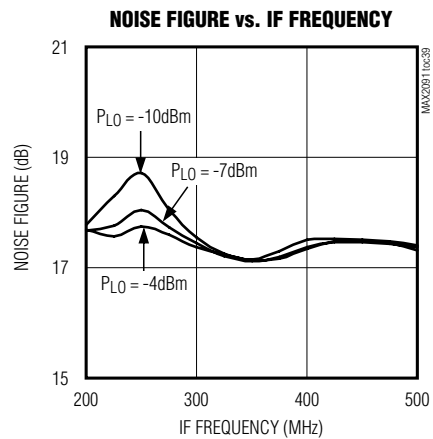
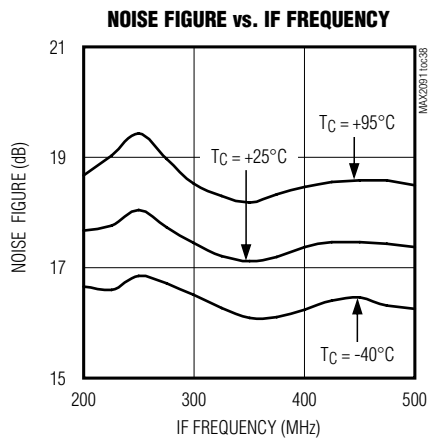
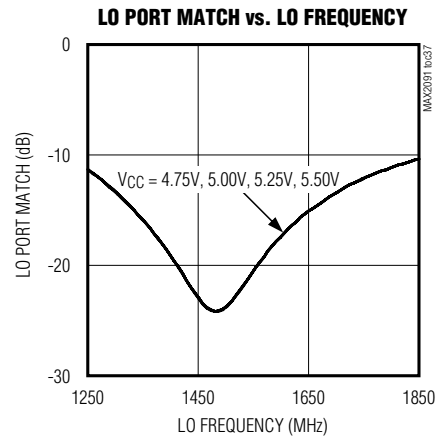
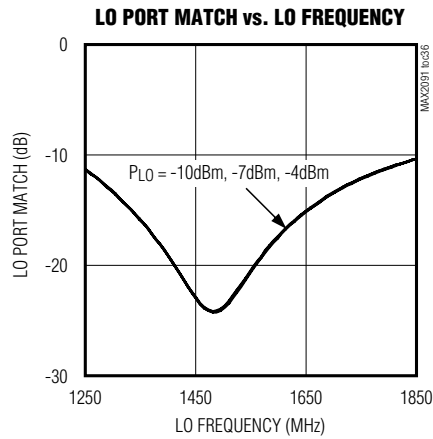
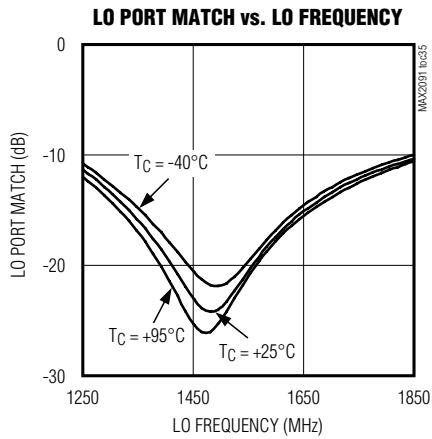

# MAX2091

## 50MHz to 500MHz Analog VGA, 1735MHz to 1935MHz Upconverting Mixer with Image Filtering, Threshold Alarm Circuit, and Error Amplifier for Level Control

### Typical Operating Characteristics (continued)

(Typical Application Circuit configured for Mixer only (MIX\_IN to RF\_OUT),  $V_{CC} = 5.5V$ ,  $T_C = +25^\circ C$ ,  $f_{MIX\_IN} = 350MHz$ ,  $P_{MIX\_IN} = -1dBm$ ,  $f_{LO} = 1485MHz$ ,  $P_{LO} = -7dBm$ ,  $f_{RF} = f_{IF\_IN} + f_{LO}$ ,  $R_{SOURCE} = R_{LOAD} = 50\Omega$ ,  $CTRL1 = 1$ ,  $CTRL2 = 0$ ,  $ALM\_THRES = ALM = open$ , unless otherwise noted.)

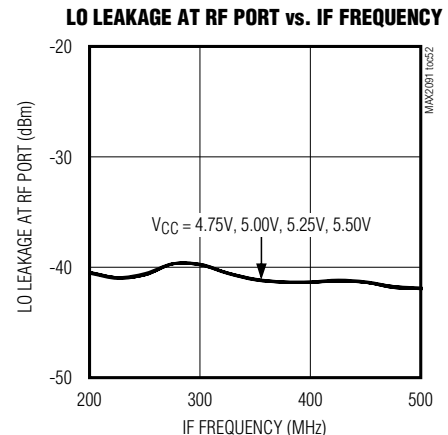
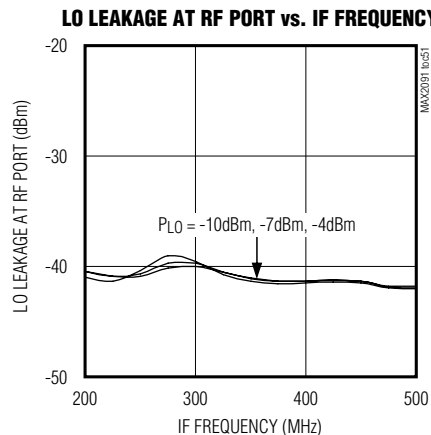
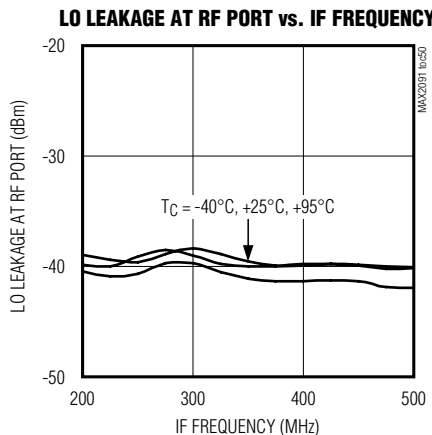
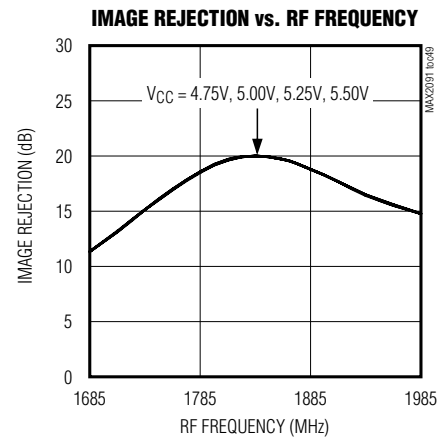
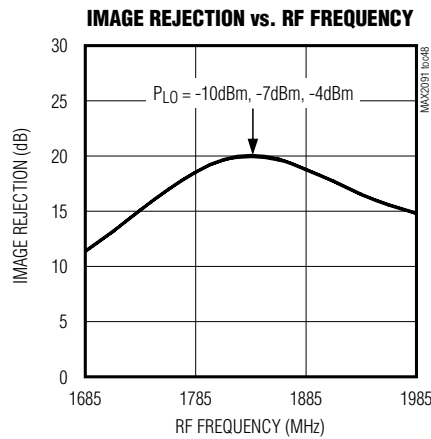
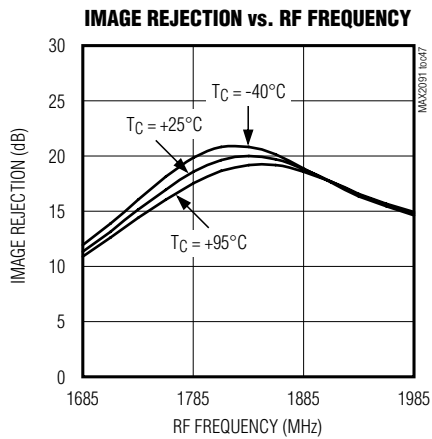
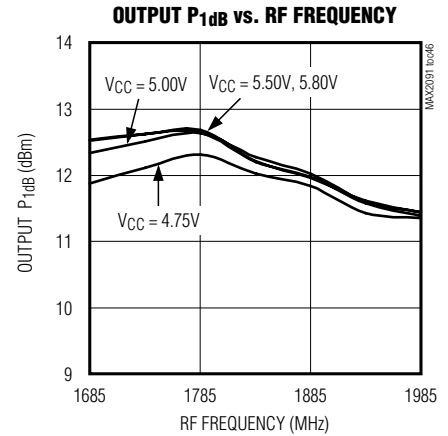
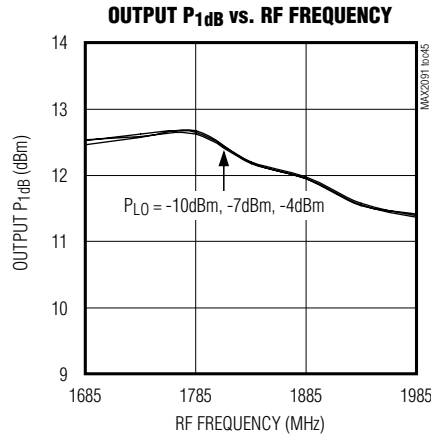
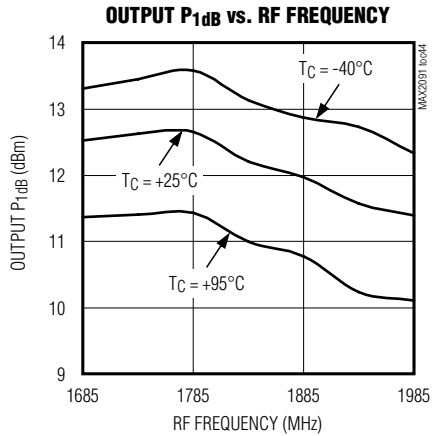

# MAX2091

## 50MHz to 500MHz Analog VGA, 1735MHz to 1935MHz Upconverting Mixer with Image Filtering, Threshold Alarm Circuit, and Error Amplifier for Level Control

### Typical Operating Characteristics (continued)

(Typical Application Circuit configured for Mixer only (MIX\_IN to RF\_OUT),  $V_{CC} = 5.5V$ ,  $T_C = +25^\circ C$ ,  $f_{MIX\_IN} = 350MHz$ ,  $P_{MIX\_IN} = -1dBm$ ,  $f_{LO} = 1485MHz$ ,  $P_{LO} = -7dBm$ ,  $f_{RF} = f_{IF\_IN} + f_{LO}$ ,  $R_{SOURCE} = R_{LOAD} = 50\Omega$ ,  $CTRL1 = 1$ ,  $CTRL2 = 0$ ,  $ALM\_THRES = ALM = open$ , unless otherwise noted.)

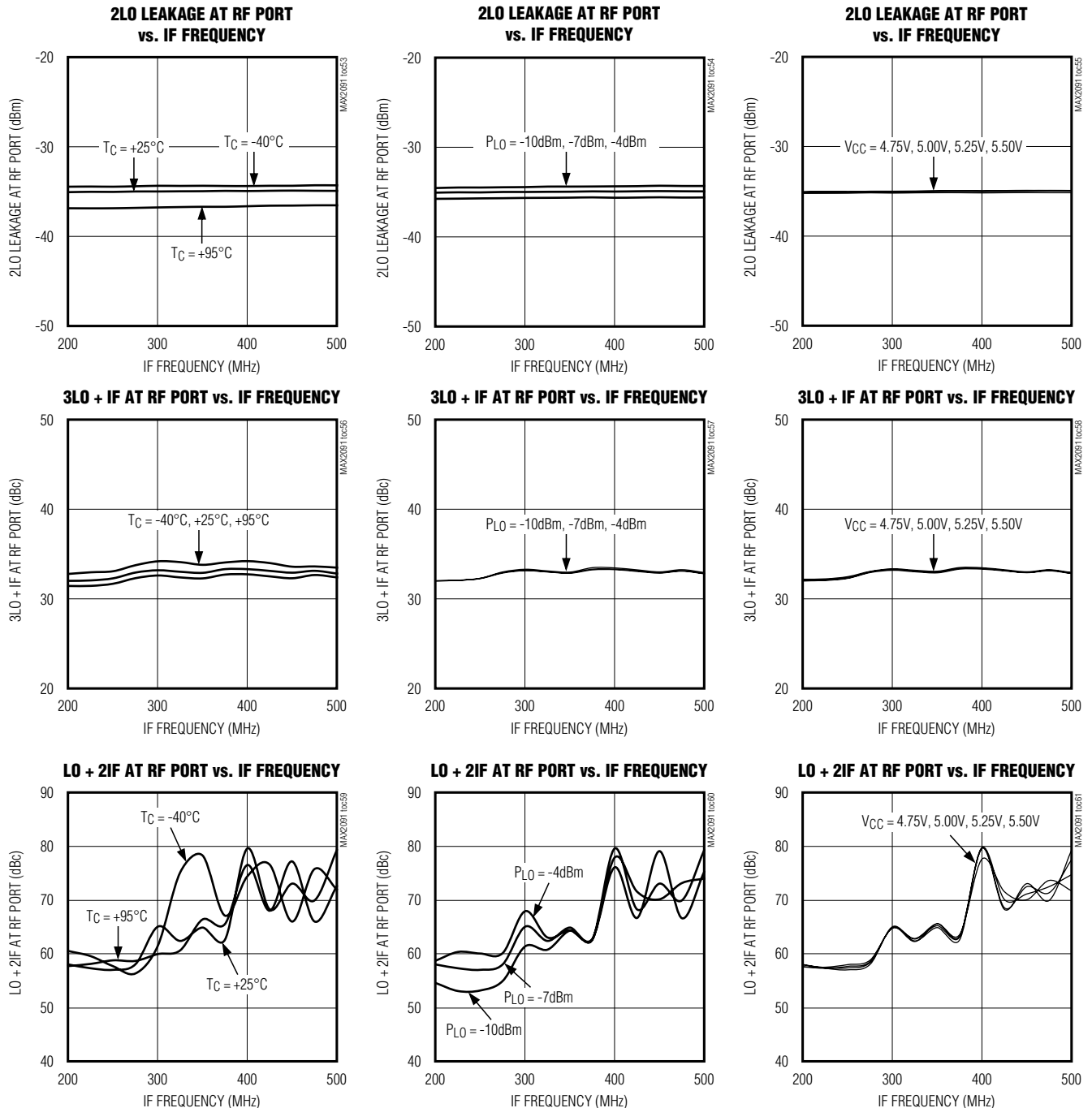

# MAX2091

## 50MHz to 500MHz Analog VGA, 1735MHz to 1935MHz Upconverting Mixer with Image Filtering, Threshold Alarm Circuit, and Error Amplifier for Level Control

### Typical Operating Characteristics (continued)

(Typical Application Circuit configured for Mixer only (MIX\_IN to RF\_OUT),  $V_{CC} = 5.5V$ ,  $T_C = +25^\circ C$ ,  $f_{MIX\_IN} = 350MHz$ ,  $P_{MIX\_IN} = -1dBm$ ,  $f_{LO} = 1485MHz$ ,  $P_{LO} = -7dBm$ ,  $f_{RF} = f_{IF\_IN} + f_{LO}$ ,  $R_{SOURCE} = R_{LOAD} = 50\Omega$ ,  $CTRL1 = 1$ ,  $CTRL2 = 0$ ,  $ALM\_THRES = ALM = open$ , unless otherwise noted.)

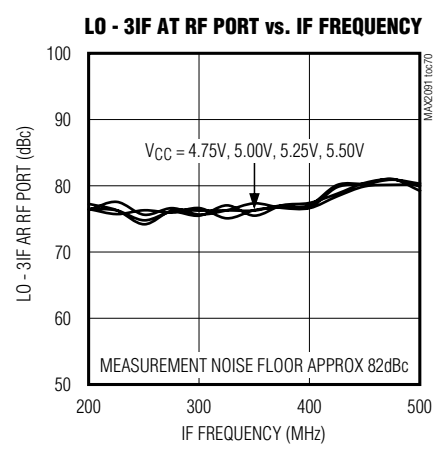
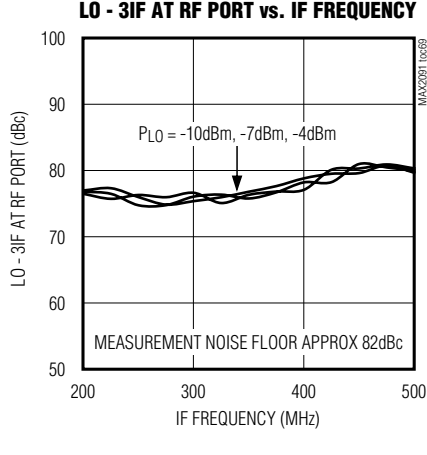
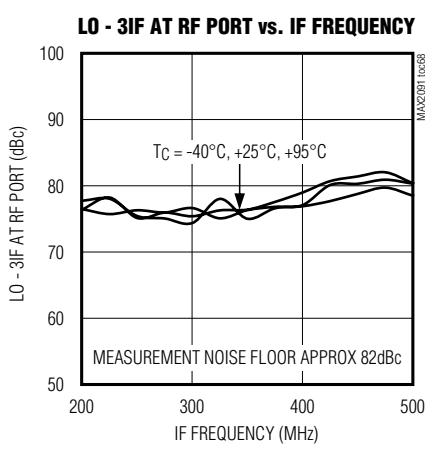
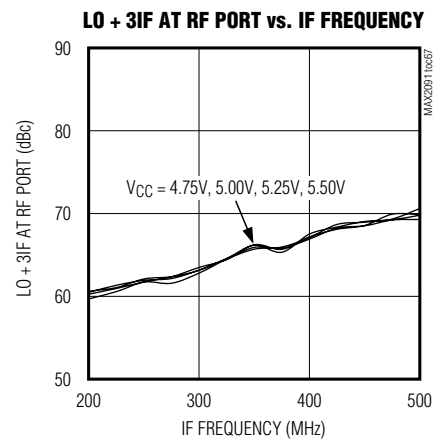
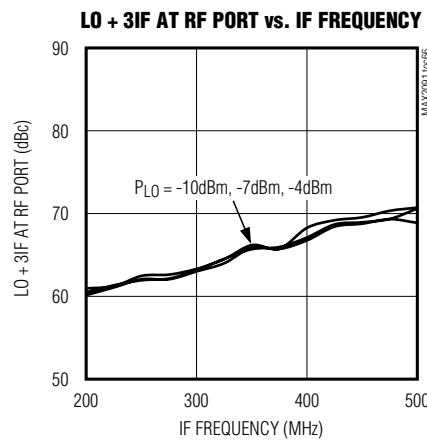
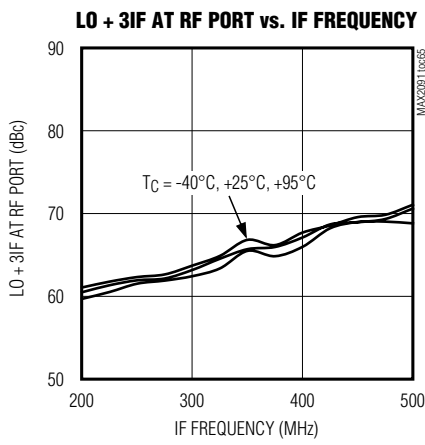
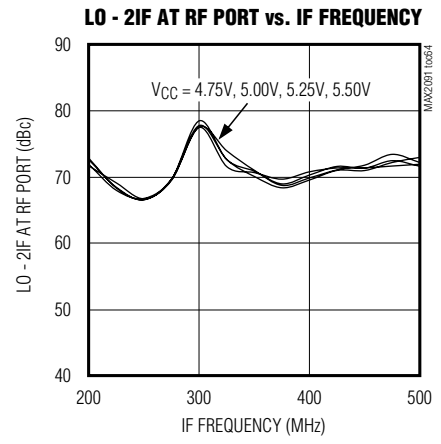
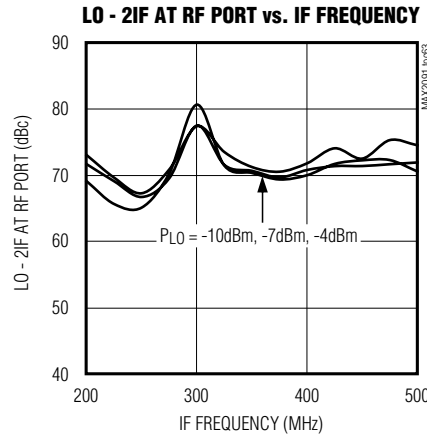
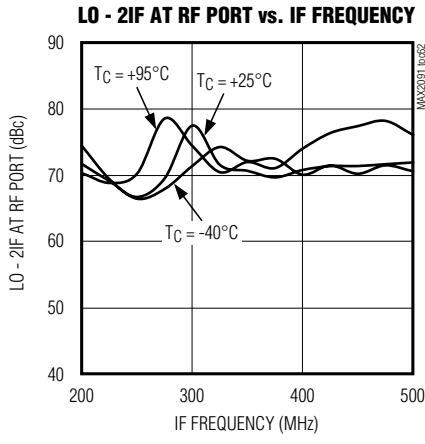

# MAX2091

## 50MHz to 500MHz Analog VGA, 1735MHz to 1935MHz Upconverting Mixer with Image Filtering, Threshold Alarm Circuit, and Error Amplifier for Level Control

### Typical Operating Characteristics (continued)

(Typical Application Circuit configured for Mixer only (MIX\_IN to RF\_OUT),  $V_{CC} = 5.5V$ ,  $T_C = +25^\circ C$ ,  $f_{MIX\_IN} = 350MHz$ ,  $P_{MIX\_IN} = -1dBm$ ,  $f_{LO} = 1485MHz$ ,  $P_{LO} = -7dBm$ ,  $f_{RF} = f_{IF\_IN} + f_{LO}$ ,  $R_{SOURCE} = R_{LOAD} = 50\Omega$ ,  $CTRL1 = 1$ ,  $CTRL2 = 0$ ,  $ALM\_THRES = ALM = open$ , unless otherwise noted.)

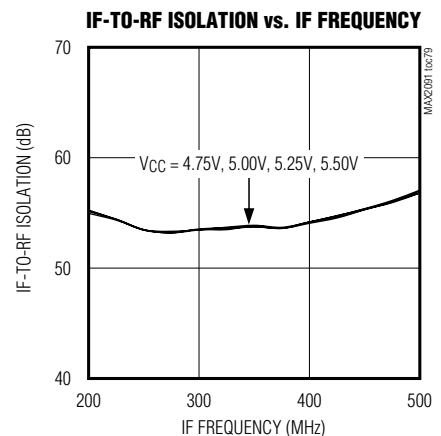
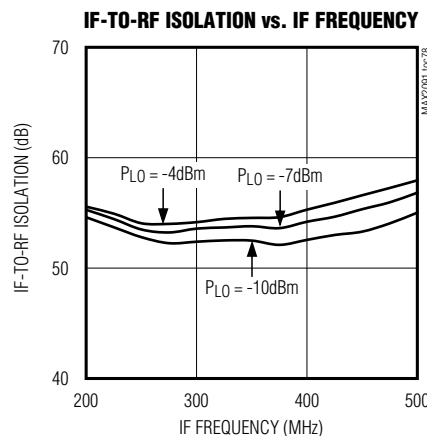
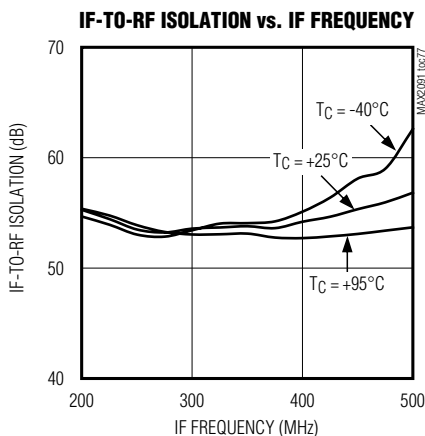
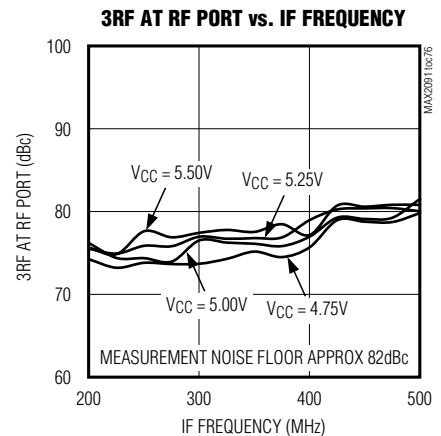
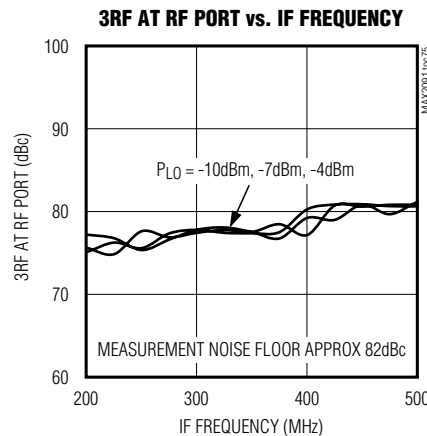
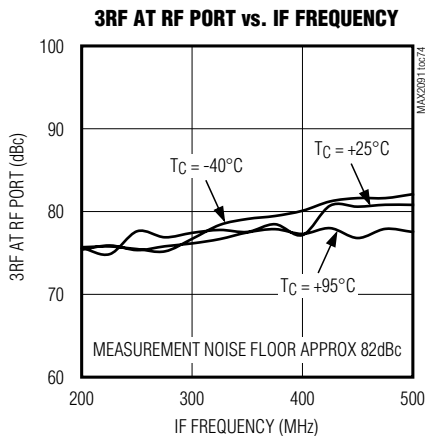
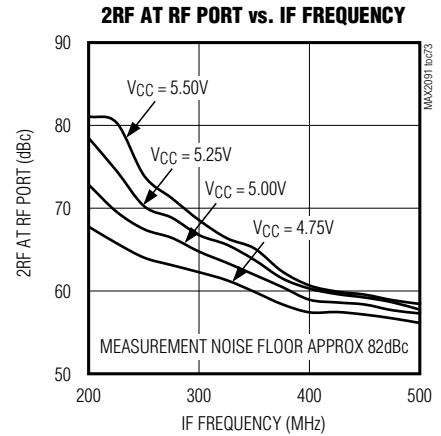
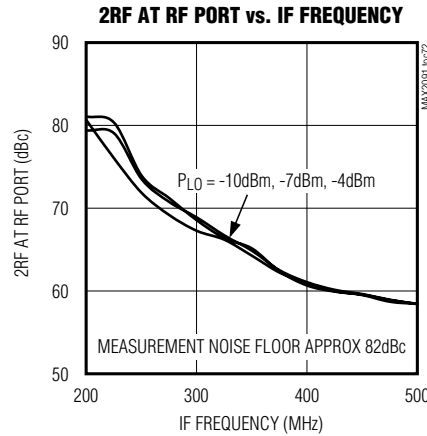
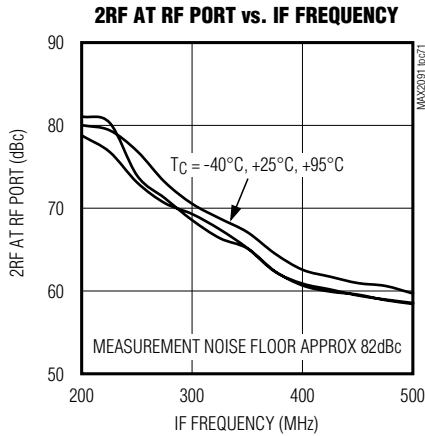

# MAX2091

## 50MHz to 500MHz Analog VGA, 1735MHz to 1935MHz Upconverting Mixer with Image Filtering, Threshold Alarm Circuit, and Error Amplifier for Level Control

### Typical Operating Characteristics (continued)

(Typical Application Circuit configured for Mixer only (MIX\_IN to RF\_OUT),  $V_{CC} = 5.5V$ ,  $T_C = +25^\circ C$ ,  $f_{MIX\_IN} = 350MHz$ ,  $P_{MIX\_IN} = -1dBm$ ,  $f_{LO} = 1485MHz$ ,  $P_{LO} = -7dBm$ ,  $f_{RF} = f_{IF\_IN} + f_{LO}$ ,  $R_{SOURCE} = R_{LOAD} = 50\Omega$ , CTRL1 = 1, CTRL2 = 0, ALM\_THRES = ALM = open, unless otherwise noted.)

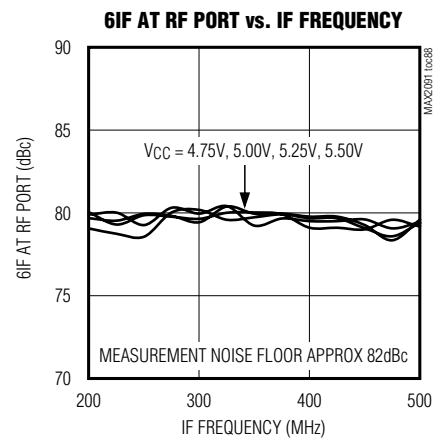
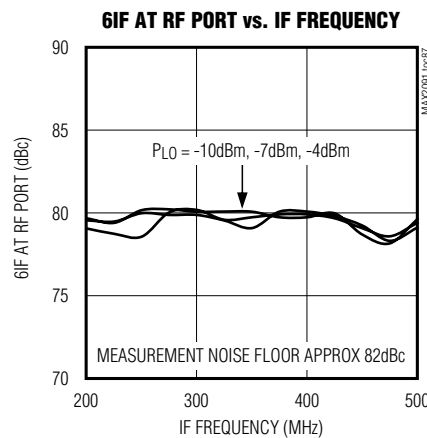
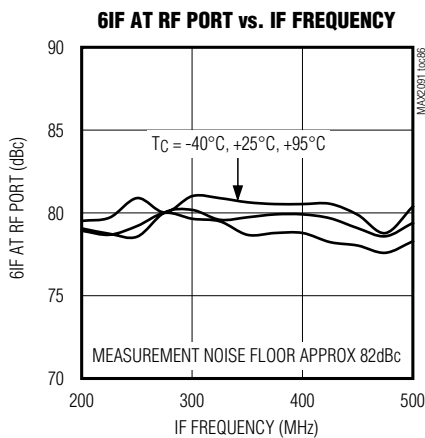
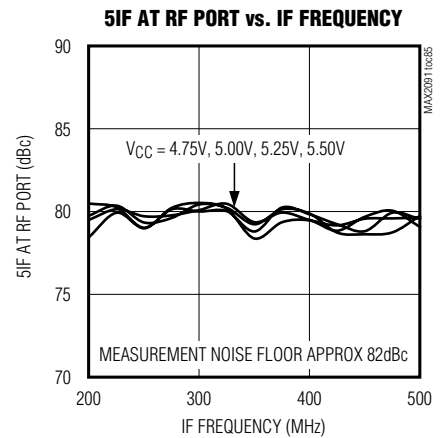
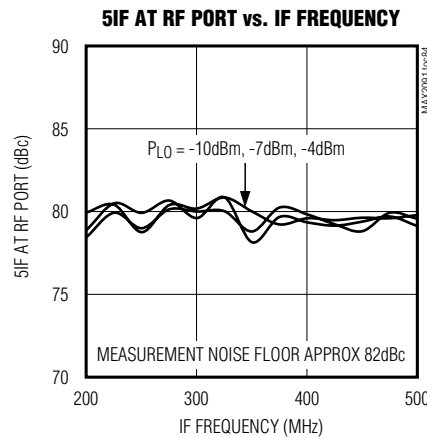
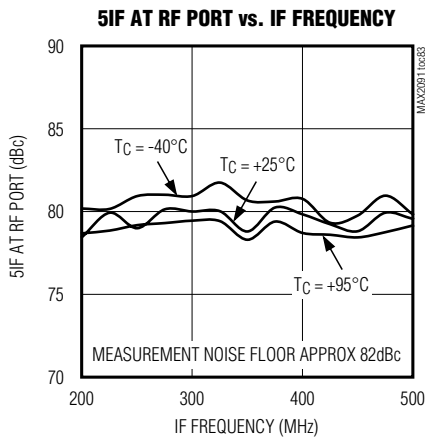
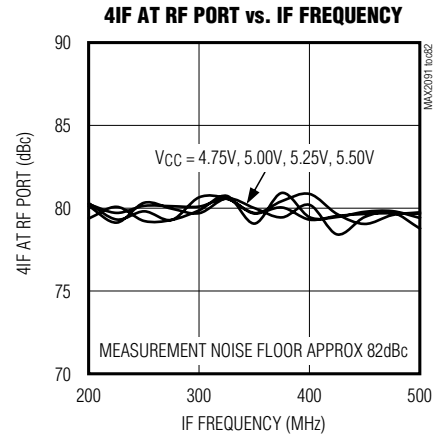
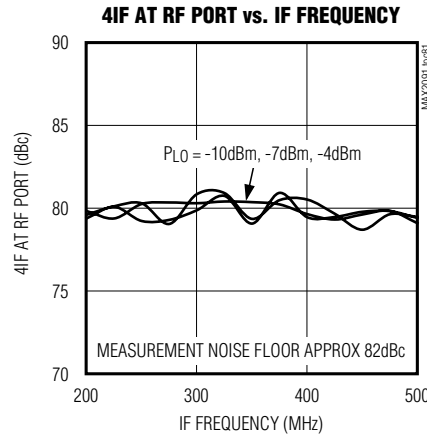
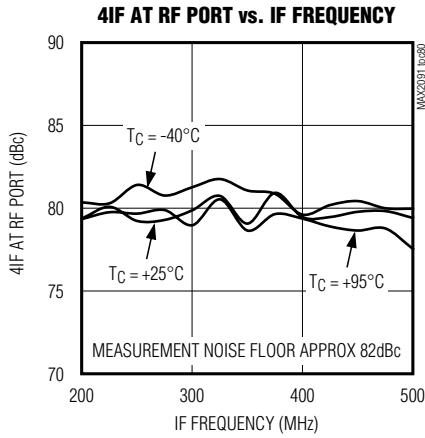

# MAX2091

## 50MHz to 500MHz Analog VGA, 1735MHz to 1935MHz Upconverting Mixer with Image Filtering, Threshold Alarm Circuit, and Error Amplifier for Level Control

### Typical Operating Characteristics (continued)

(Typical Application Circuit configured for Full Cascade with interstage attenuator network (IF\_IN to RF\_OUT), analog attenuator set to maximum gain ( $V_{PLVLSET} = 2.5V$ ),  $V_{CC} = 5.5V$ ,  $T_C = +25^\circ C$ ,  $f_{IF\_IN} = 350MHz$ ,  $P_{IF\_IN} = -25dBm$ ,  $f_{LO} = 1485MHz$ ,  $P_{LO} = -7dBm$ ,  $f_{RF} = f_{IF\_IN} + f_{LO}$ ,  $R_{SOURCE} = R_{LOAD} = 50\Omega$ ,  $CTRL1 = 1$   $CTRL2 = 0$ ,  $ALM\_THRES = ALM = open$ , unless otherwise noted.)

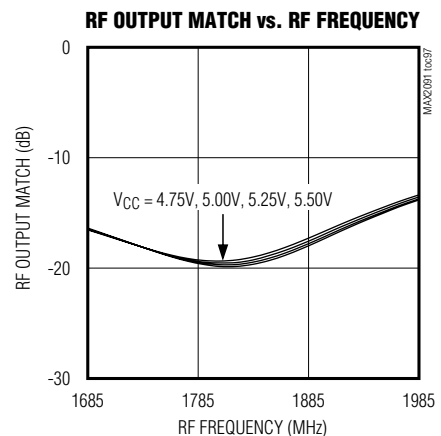
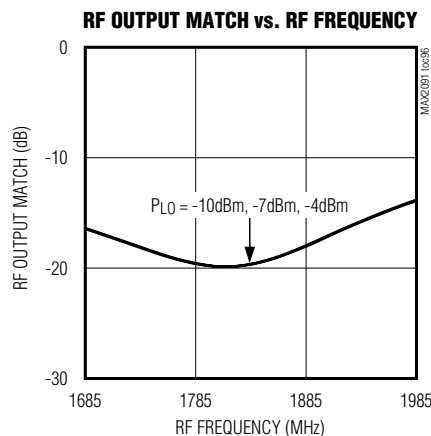
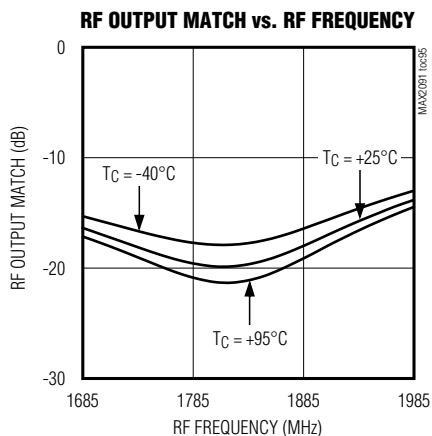
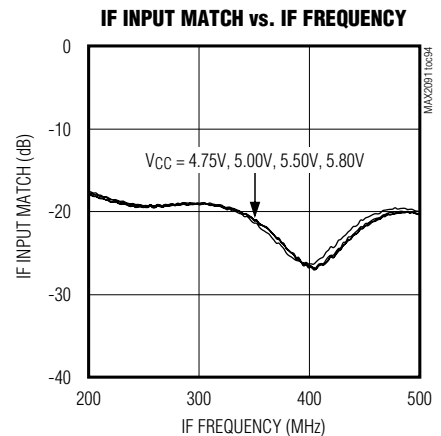
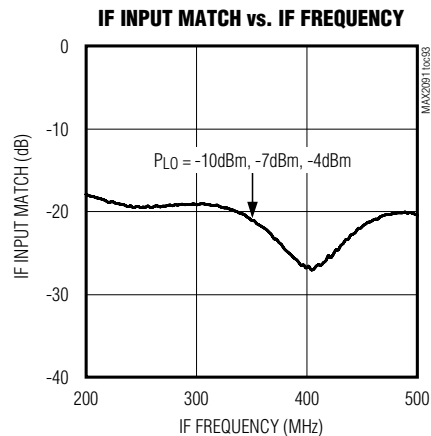
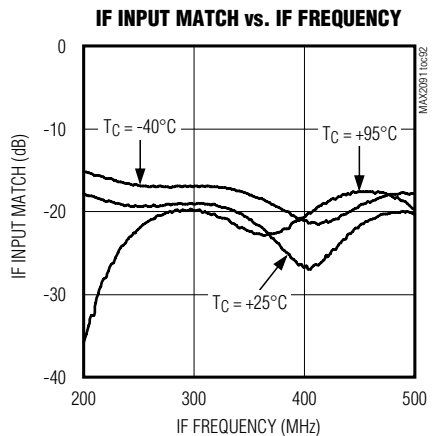
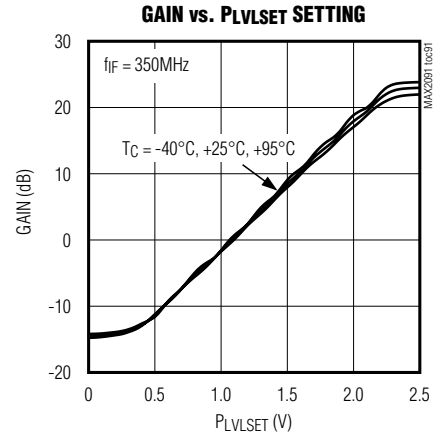
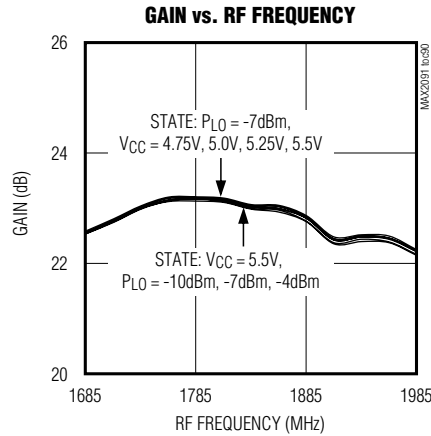
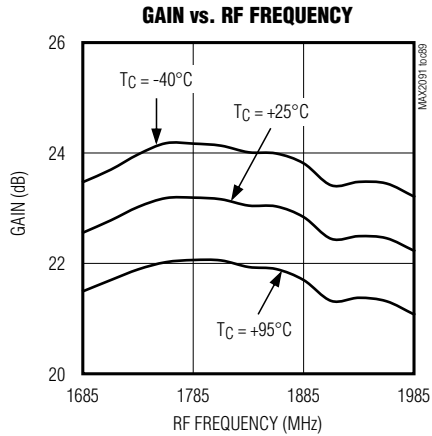



# MAX2091

## 50MHz to 500MHz Analog VGA, 1735MHz to 1935MHz Upconverting Mixer with Image Filtering, Threshold Alarm Circuit, and Error Amplifier for Level Control

### Typical Operating Characteristics (continued)

(Typical Application Circuit configured for Full Cascade with interstage attenuator network (IF\_IN to RF\_OUT), analog attenuator set to maximum gain ( $V_{PLVLSET} = 2.5V$ ),  $V_{CC} = 5.5V$ ,  $T_C = +25^\circ C$ ,  $f_{IF\_IN} = 350MHz$ ,  $P_{IF\_IN} = -25dBm$ ,  $f_{LO} = 1485MHz$ ,  $P_{LO} = -7dBm$ ,  $f_{RF} = f_{IF\_IN} + f_{LO}$ ,  $R_{SOURCE} = R_{LOAD} = 50\Omega$ ,  $CTRL1 = 1$   $CTRL2 = 0$ ,  $ALM\_THRES = ALM = open$ , unless otherwise noted.)

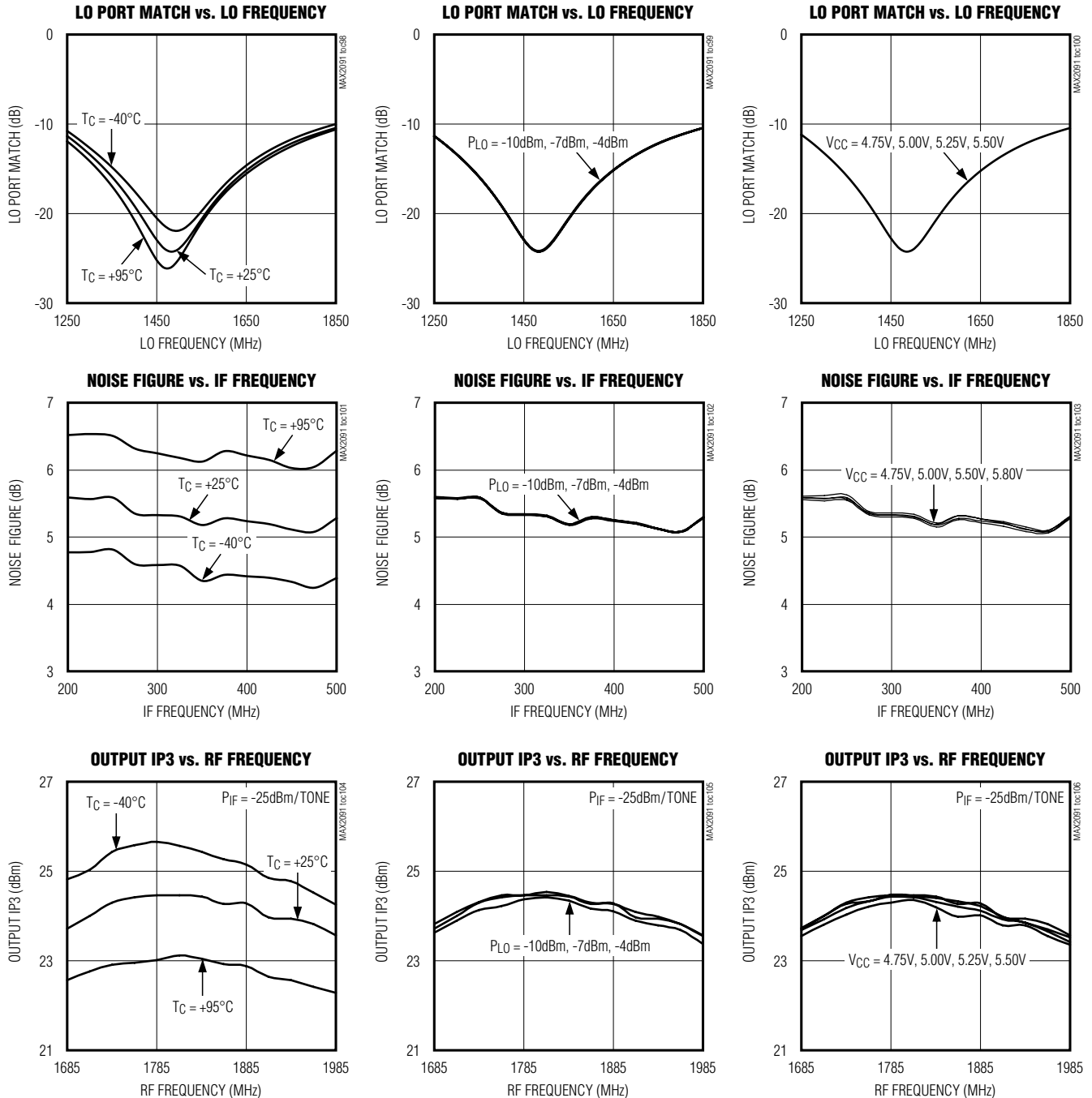

# MAX2091

## 50MHz to 500MHz Analog VGA, 1735MHz to 1935MHz Upconverting Mixer with Image Filtering, Threshold Alarm Circuit, and Error Amplifier for Level Control

### Typical Operating Characteristics (continued)

(Typical Application Circuit configured for Full Cascade with interstage attenuator network (IF\_IN to RF\_OUT), analog attenuator set to maximum gain ( $V_{PLVLSSET} = 2.5V$ ),  $V_{CC} = 5.5V$ ,  $T_C = +25^\circ C$ ,  $f_{IF\_IN} = 350MHz$ ,  $P_{IF\_IN} = -25dBm$ ,  $f_{LO} = 1485MHz$ ,  $P_{LO} = -7dBm$ ,  $f_{RF} = f_{IF\_IN} + f_{LO}$ ,  $R_{SOURCE} = R_{LOAD} = 50\Omega$ ,  $CTRL1 = 1$   $CTRL2 = 0$ ,  $ALM\_THRES = ALM = open$ , unless otherwise noted.)

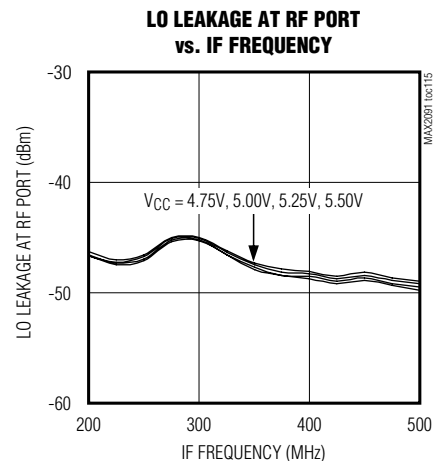
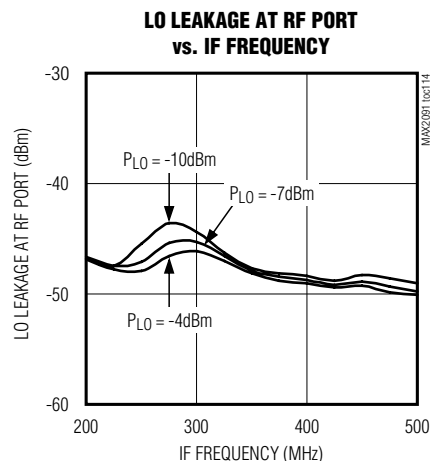
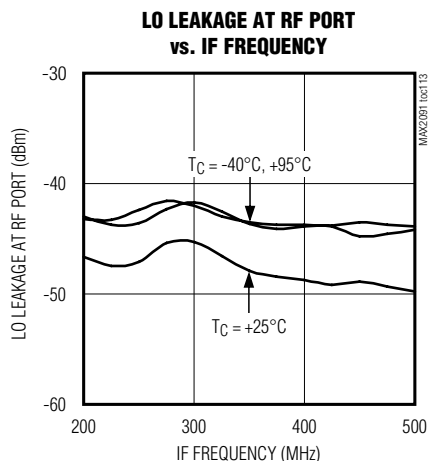
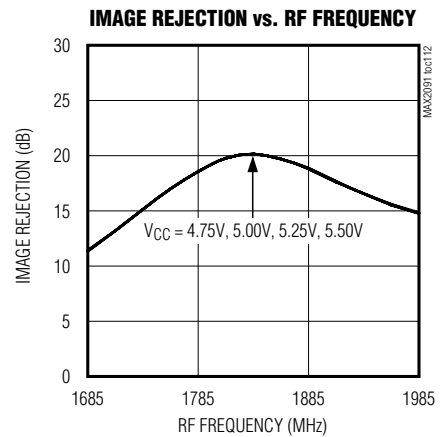
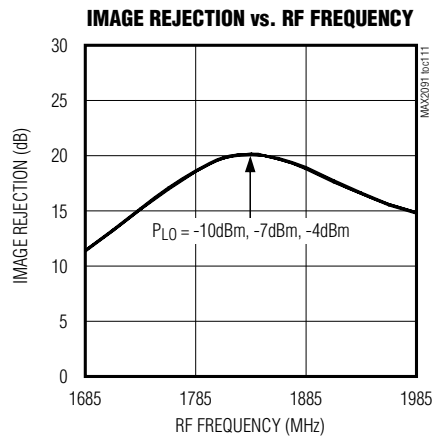
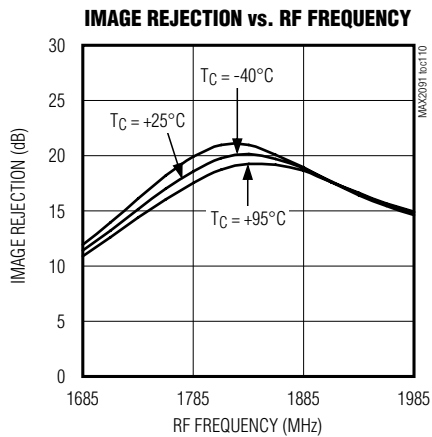
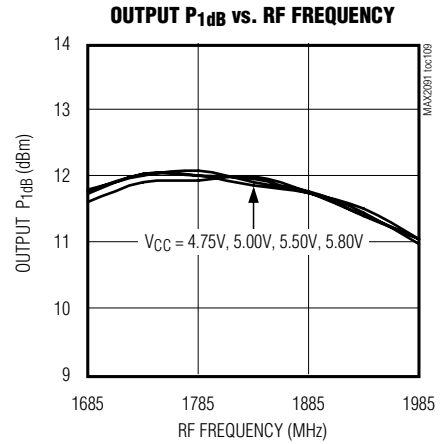
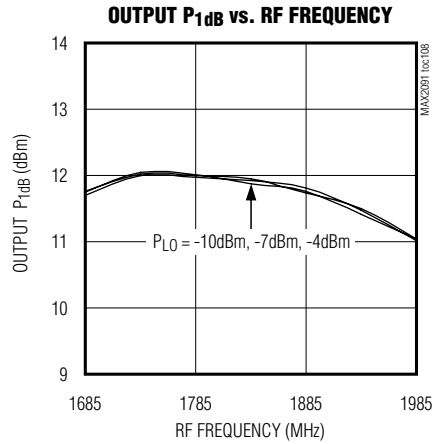
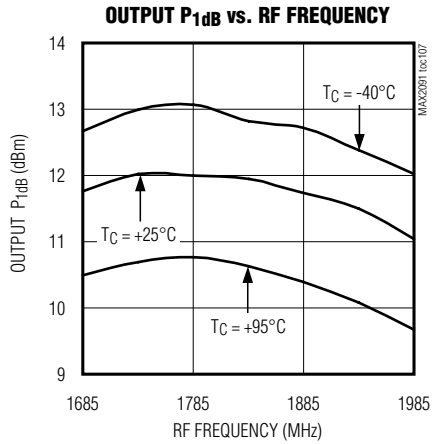

# MAX2091

## 50MHz to 500MHz Analog VGA, 1735MHz to 1935MHz Upconverting Mixer with Image Filtering, Threshold Alarm Circuit, and Error Amplifier for Level Control

### Typical Operating Characteristics (continued)

(Typical Application Circuit configured for Full Cascade with interstage attenuator network (IF\_IN to RF\_OUT), analog attenuator set to maximum gain ( $V_{PLVLSET} = 2.5V$ ),  $V_{CC} = 5.5V$ ,  $T_C = +25^\circ C$ ,  $f_{IF\_IN} = 350MHz$ ,  $P_{IF\_IN} = -25dBm$ ,  $f_{LO} = 1485MHz$ ,  $P_{LO} = -7dBm$ ,  $f_{RF} = f_{IF\_IN} + f_{LO}$ ,  $R_{SOURCE} = R_{LOAD} = 50\Omega$ ,  $CTRL1 = 1$   $CTRL2 = 0$ ,  $ALM\_THRES = ALM = open$ , unless otherwise noted.)

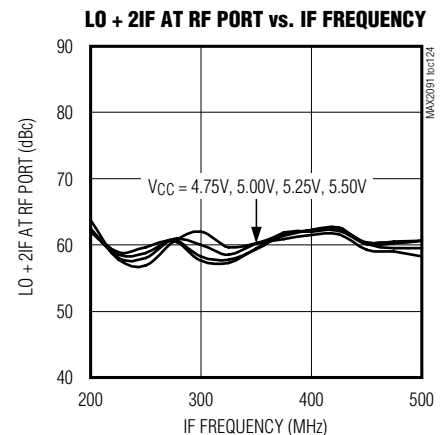
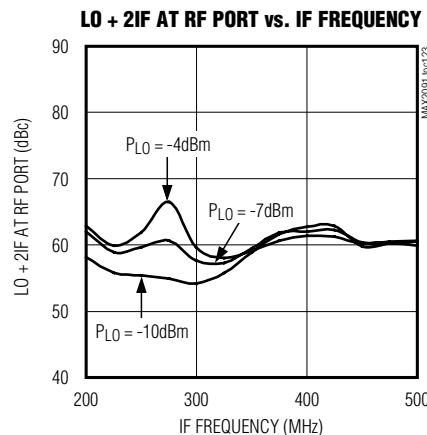
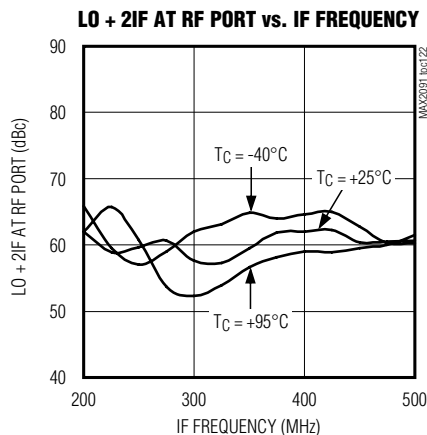
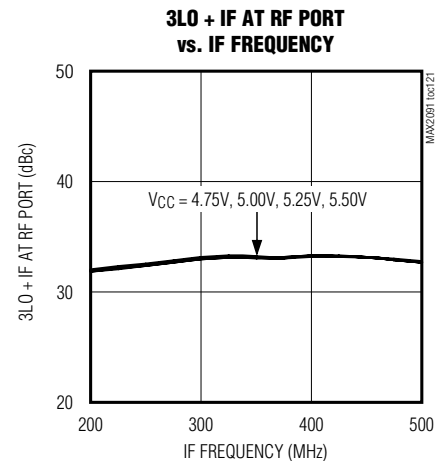
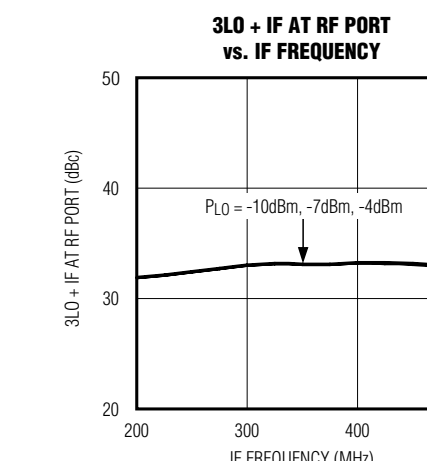
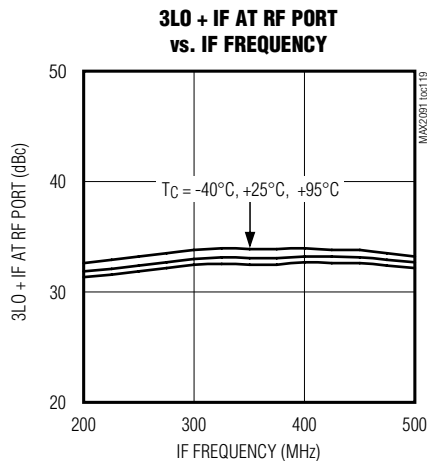
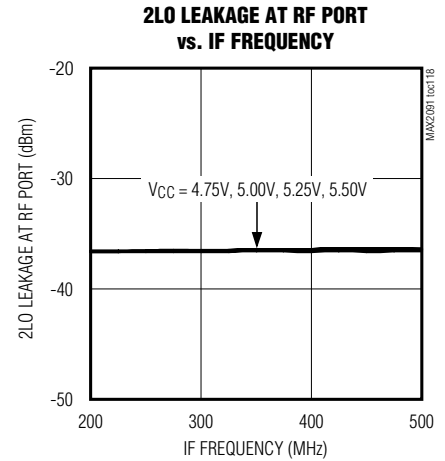
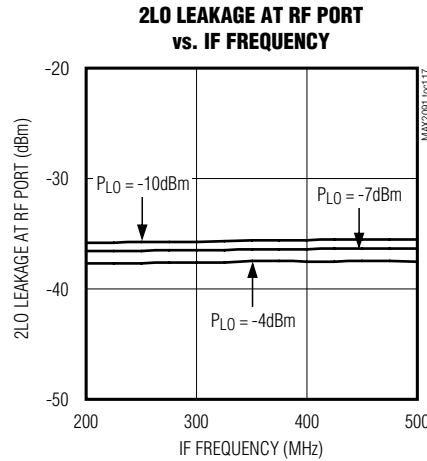
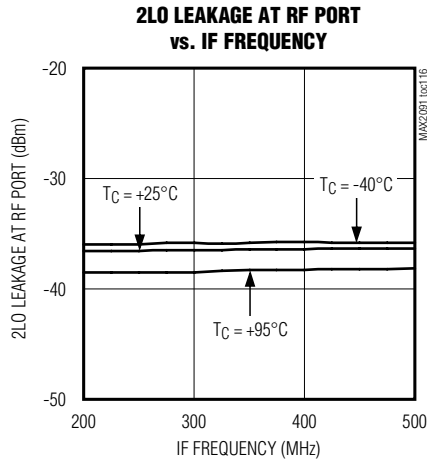

# MAX2091

## 50MHz to 500MHz Analog VGA, 1735MHz to 1935MHz Upconverting Mixer with Image Filtering, Threshold Alarm Circuit, and Error Amplifier for Level Control

### Typical Operating Characteristics (continued)

(Typical Application Circuit configured for Full Cascade with interstage attenuator network (IF\_IN to RF\_OUT), analog attenuator set to maximum gain ( $V_{PLVLSET} = 2.5V$ ),  $V_{CC} = 5.5V$ ,  $T_C = +25^\circ C$ ,  $f_{IF\_IN} = 350MHz$ ,  $P_{IF\_IN} = -25dBm$ ,  $f_{LO} = 1485MHz$ ,  $P_{LO} = -7dBm$ ,  $f_{RF} = f_{IF\_IN} + f_{LO}$ ,  $R_{SOURCE} = R_{LOAD} = 50\Omega$ ,  $CTRL1 = 1$   $CTRL2 = 0$ ,  $ALM\_THRES = ALM = open$ , unless otherwise noted.)

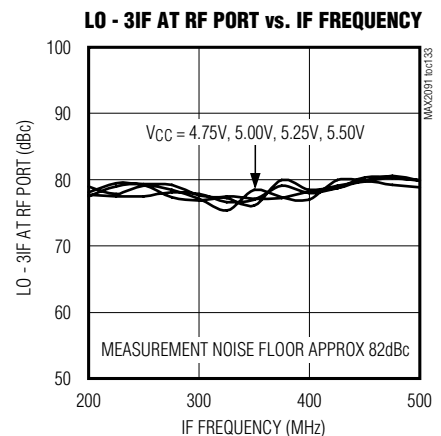
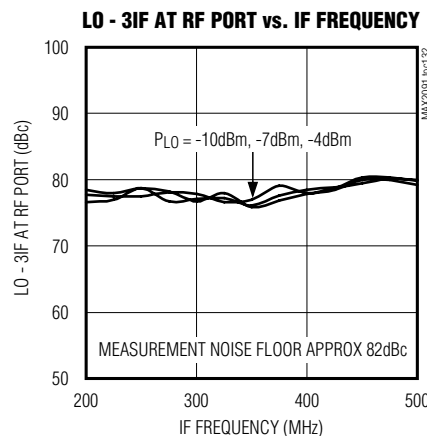
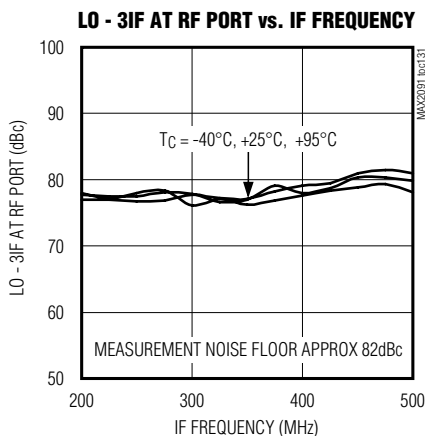
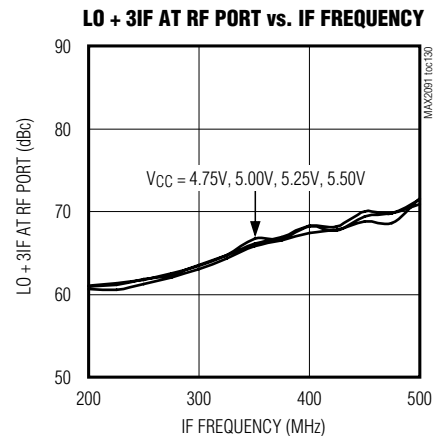
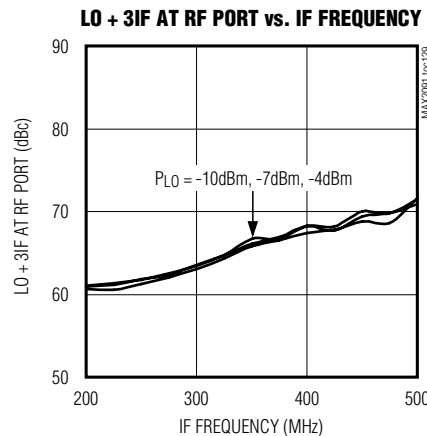
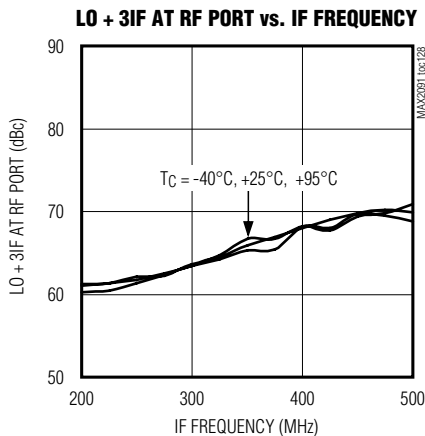
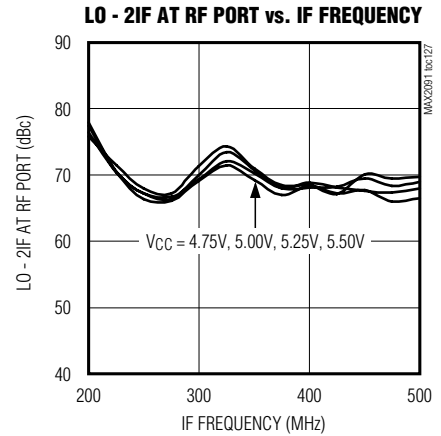
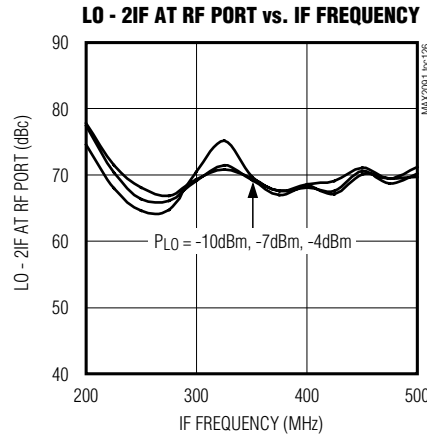
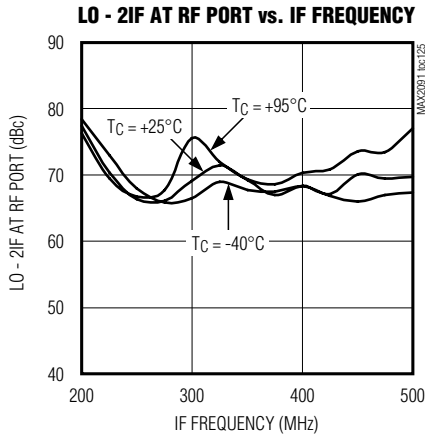

# MAX2091

## 50MHz to 500MHz Analog VGA, 1735MHz to 1935MHz Upconverting Mixer with Image Filtering, Threshold Alarm Circuit, and Error Amplifier for Level Control

### Typical Operating Characteristics (continued)

(Typical Application Circuit configured for Full Cascade with interstage attenuator network (IF\_IN to RF\_OUT), analog attenuator set to maximum gain ( $V_{PLVLSET} = 2.5V$ ),  $V_{CC} = 5.5V$ ,  $T_C = +25^\circ C$ ,  $f_{IF\_IN} = 350MHz$ ,  $P_{IF\_IN} = -25dBm$ ,  $f_{LO} = 1485MHz$ ,  $P_{LO} = -7dBm$ ,  $f_{RF} = f_{IF\_IN} + f_{LO}$ ,  $R_{SOURCE} = R_{LOAD} = 50\Omega$ ,  $CTRL1 = 1$   $CTRL2 = 0$ ,  $ALM\_THRES = ALM = open$ , unless otherwise noted.)

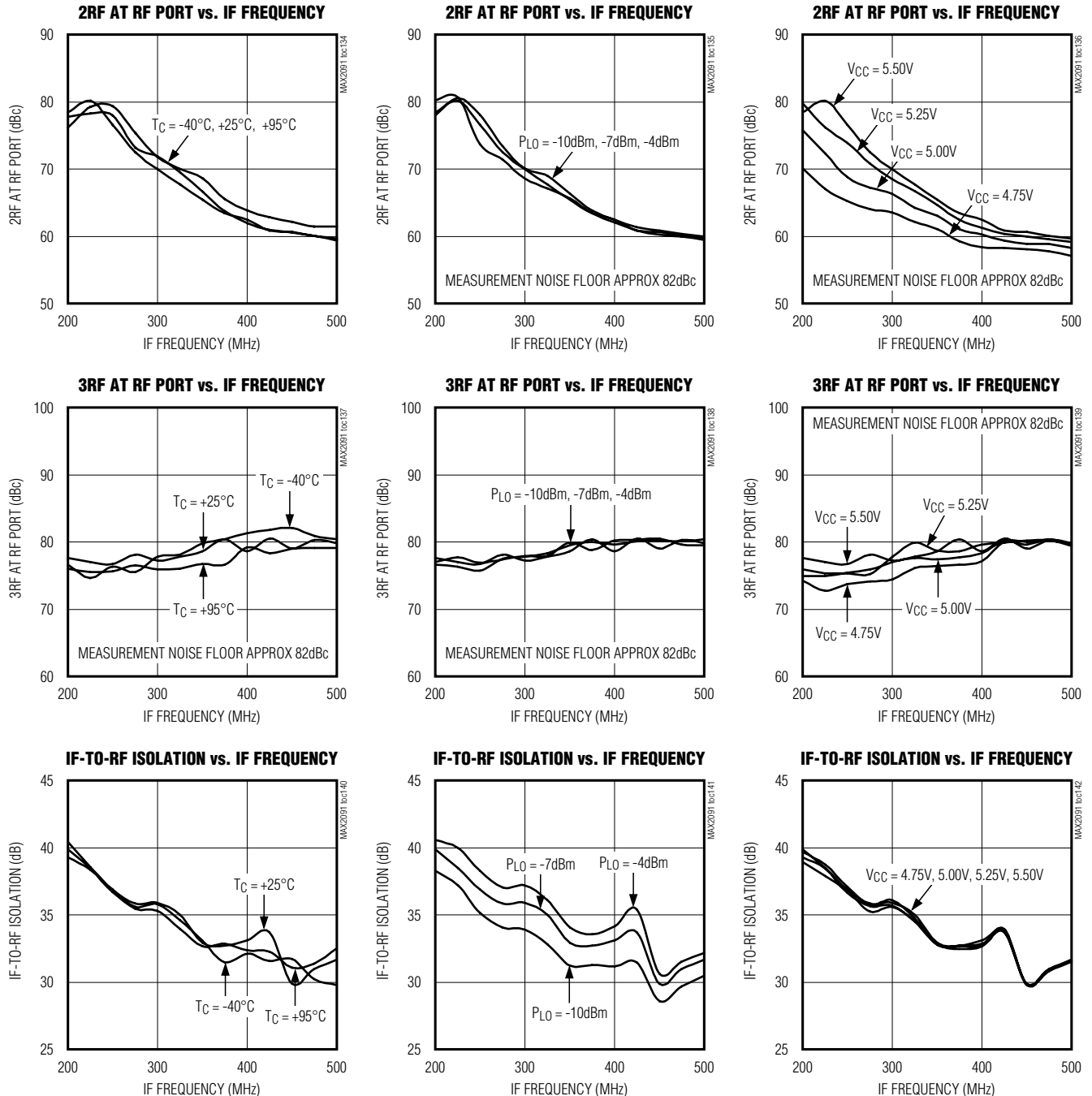

# MAX2091

## 50MHz to 500MHz Analog VGA, 1735MHz to 1935MHz Upconverting Mixer with Image Filtering, Threshold Alarm Circuit, and Error Amplifier for Level Control

### Typical Operating Characteristics (continued)

(Typical Application Circuit configured for Full Cascade with interstage attenuator network (IF\_IN to RF\_OUT), analog attenuator set to maximum gain ( $V_{PLVLSET} = 2.5V$ ),  $V_{CC} = 5.5V$ ,  $T_C = +25^\circ C$ ,  $f_{IF\_IN} = 350MHz$ ,  $P_{IF\_IN} = -25dBm$ ,  $f_{LO} = 1485MHz$ ,  $P_{LO} = -7dBm$ ,  $f_{RF} = f_{IF\_IN} + f_{LO}$ ,  $R_{SOURCE} = R_{LOAD} = 50\Omega$ ,  $CTRL1 = 1$   $CTRL2 = 0$ ,  $ALM\_THRES = ALM = open$ , unless otherwise noted.)

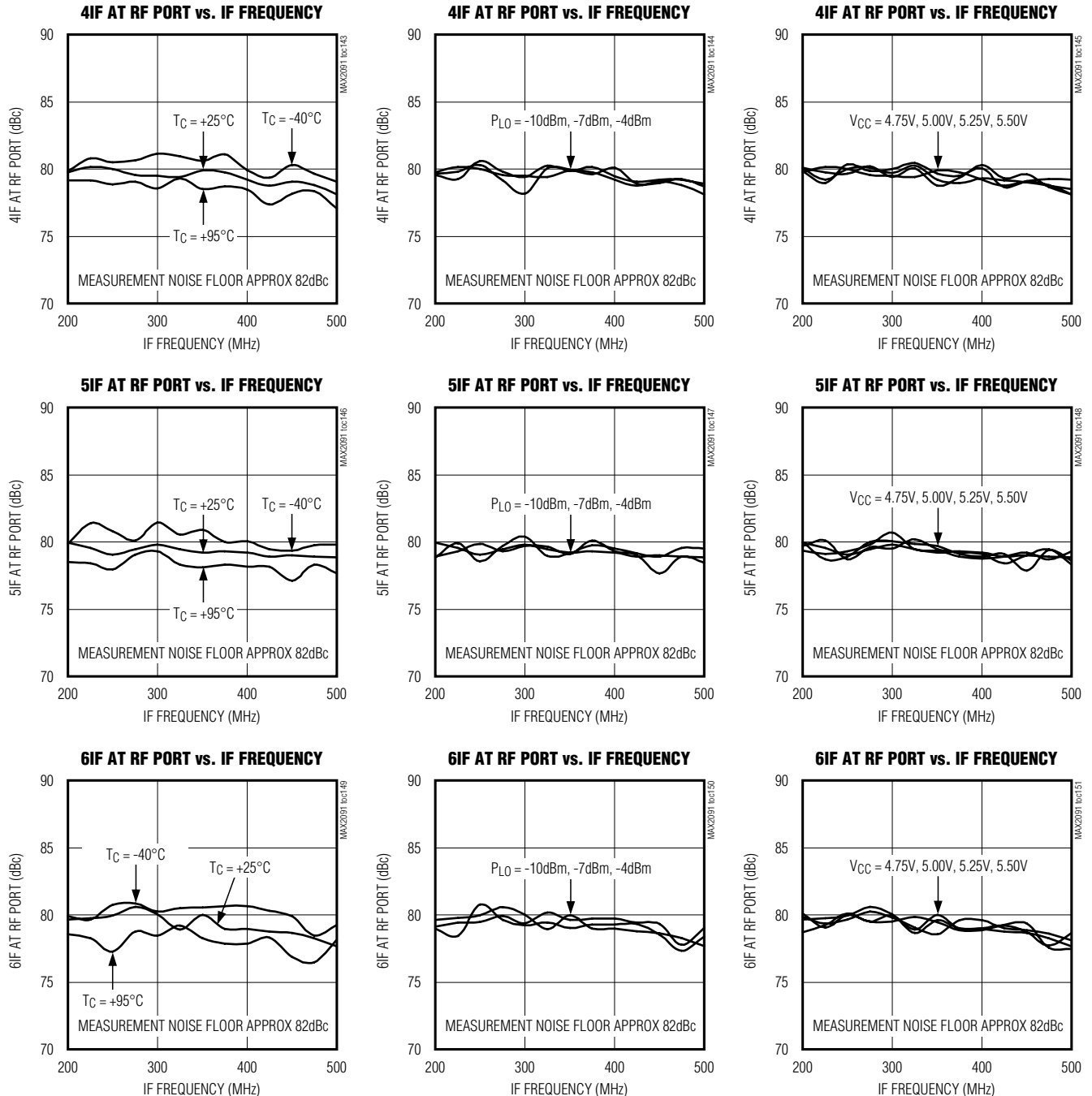

# MAX2091

## 50MHz to 500MHz Analog VGA, 1735MHz to 1935MHz Upconverting Mixer with Image Filtering, Threshold Alarm Circuit, and Error Amplifier for Level Control

### Pin Configuration

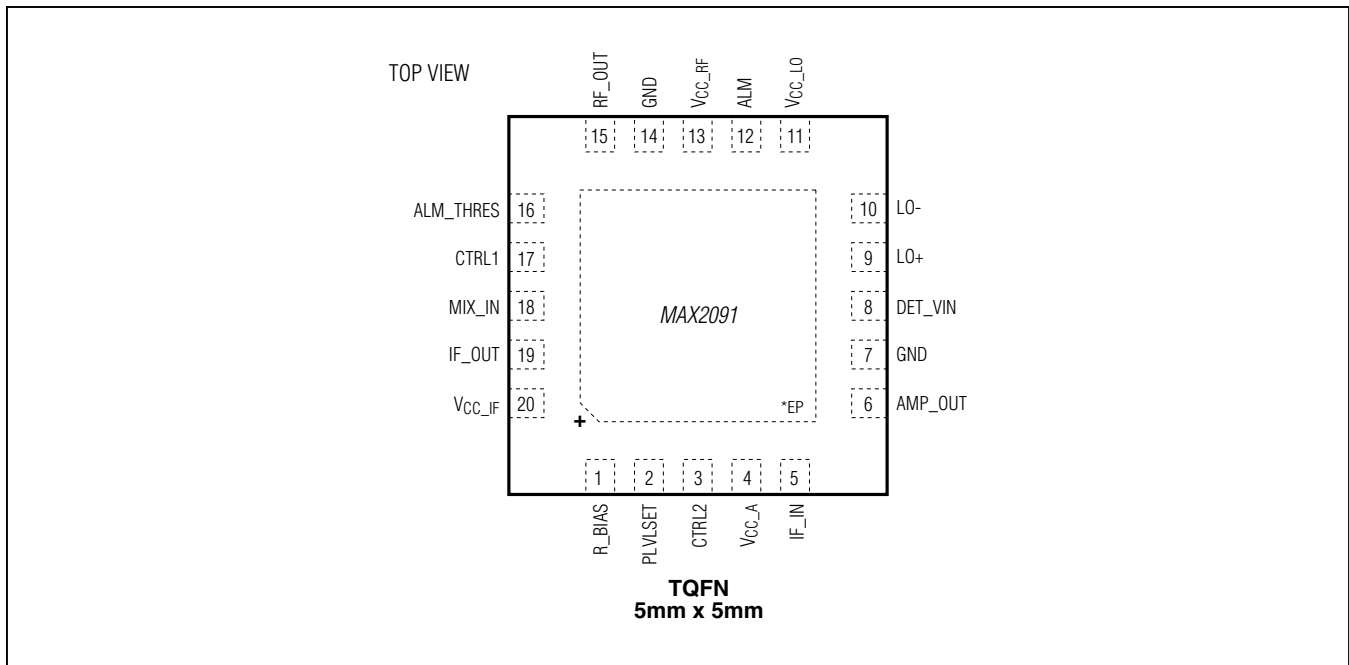

### Pin Description

PIN	NAME	FUNCTION
1	R_BIAS	Bias Resistor Setting Input. Connect a resistor from this pin to ground.
2	PLVLSET	AGC Loop Threshold-Level Input/Attenuator Control
3	CTRL2	Functional Control Bit (see Table 1)
4	V <sub>CC_A</sub>	Power-Supply Input. Bypass to ground with a 10nF capacitor as close as possible to the pin.
5	IF_IN	Attenuator Input (50Ω). Requires a DC-blocking capacitor.
6	AMP_OUT	Error Amplifier Output
7, 14	GND	Ground
8	DET_VIN	Error Amplifier Input Voltage from an External Detector
9	LO+	Positive LO Input. Requires a DC-blocking capacitor.
10	LO-	Negative LO Input. Connect to ground.
11	V <sub>CC_LO</sub>	LO Driver Supply Voltage Input. Bypass to ground with 1μF and 10nF capacitors as close as possible to the pin.
12	ALM	Alarm Logic Output
13	V <sub>CC_RF</sub>	Mixer Supply Voltage Input. Bypass to ground with a 10nF capacitor as close as possible to the pin.
15	RF_OUT	Mixer Output. Requires a DC-blocking capacitor.
16	ALM_THRES	Alarm Threshold Voltage Input. See the <i>Alarm Operation</i> section for operation details.

# MAX2091

## 50MHz to 500MHz Analog VGA, 1735MHz to 1935MHz Upconverting Mixer with Image Filtering, Threshold Alarm Circuit, and Error Amplifier for Level Control

### *Pin Description (continued)*

PIN	NAME	FUNCTION
17	CTRL1	Functional Control Bit (see Table 1)
18	MIX_IN	Mixer Input. See the <i>Typical Application Circuit</i> for connection details.
19	IF_OUT	Driver Amplifier Output (50Ω). See the <i>Typical Application Circuit</i> for connection details.
20	V <sub>CC_IF</sub>	Driver-Amplifier Supply Voltage Input. Bypass to ground with a 10nF capacitor as close as possible to the pin.
—	EP	Exposed Pad. Internally connected to GND. Solder this exposed pad to a PCB pad that uses multiple ground vias to provide heat transfer out of the device into the PCB ground planes. These multiple via grounds are also required to achieve the noted RF performance (see the <i>Layout Considerations</i> section).

**Table 1. Mode Control Logic**

CTRL1	CTRL2	VGA	MIXER	ERROR AMPLIFIER	ALC LOOP	ALARM	FUNCTIONAL DESCRIPTION
0	0	Disabled	Disabled	Disabled	Disabled	Disabled	Power-Down Mode
1	0	Enabled	Enabled	Disabled	Disabled	Disabled	VGA/Mixer Only Mode
1	1	Enabled	Enabled	Enabled	Enabled	Enabled	Closed ALC Mode: ALC loop locks DET_VIN to PLVLSET
0	1	—	—	—	—	—	<b>Factory Test Mode (Do Not Use)</b>

### ***Detailed Description***

The MAX2091 is a monolithic SiGe BiCMOS upconverter IC that integrates an analog variable-gain amplifier, an upconverting mixer stage, and image filter. The device amplifies IF signals in the 50MHz to 500MHz range before mixing them with an LO signal. The resulting 1735MHz to 1935MHz upconverted signal is then filtered on-chip as the final stage of signal conditioning.

The analog attenuator is controlled by an external analog control voltage. Device features include 23dB gain (no attenuation), 5.4dB NF (no attenuation, including attenuator insertion loss), and +24.5dBm OIP3. Each of these features makes the MAX2091 an ideal upconverter for numerous transmitter applications. When paired with the MAX2092 RF VGA, a complete 2-chip IF-RF signal conditioning solution is possible for microwave point-to-point transmitter applications.

### ***Applications Information***

#### ***Modes of Operation***

The MAX2091 can operate in several different modes, as summarized in [Table 1](#).

#### ***VGA/Mixer-Only Mode Operation***

VGA/mixer-only mode operation consists of setting CTRL1 = logic 1 and CTRL2 = logic 0 and applying a DC value to PLVLSET between 0 and 2.5V DC, to manually adjust the IF attenuator and subsequently the RF\_OUT power. The output power at RF\_OUT increases at a rate of 19.5dB/V as PLVLSET is increased when IF\_IN is driven with a fixed input power between -25dBm and +5dBm. The error amplifier and alarm are powered off in this mode, reducing the supply current (10mA typ). In VGA/mixer-only mode, components R5, R7, C8, C9, and C16 are left unpopulated.



# MAX2091

## 50MHz to 500MHz Analog VGA, 1735MHz to 1935MHz Upconverting Mixer with Image Filtering, Threshold Alarm Circuit, and Error Amplifier for Level Control

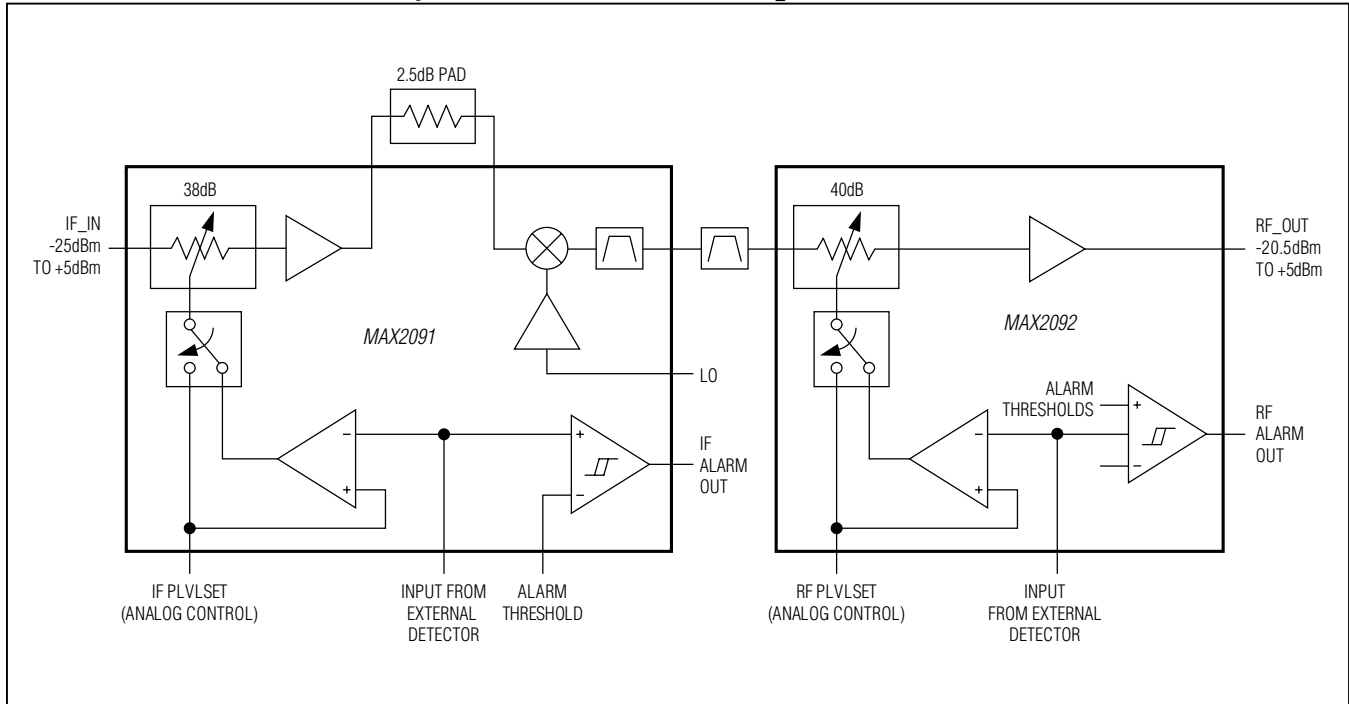

Figure 1. Cascaded IF-RF Lineup Using the MAX2091 and MAX2092

### Closed-ALC Mode Operation

Closed-ALC mode operation consists of setting CTRL1 = CTRL2 = logic 1. The voltage on PLVLSSET is set externally to provide -3dBm at RF\_OUT for IF\_IN power between -25dBm and +5dBm. For other input power ranges, PLVLSSET can be externally driven to any DC value between 0 and 2.5V, such that the desired output power is present at RF\_OUT (see the [Typical Application Circuit](#)). An error amplifier compares the external detector's voltage to that of PLVLSSET, and drives the IF attenuator in servo fashion until the error amplifier's differential input error voltage is near zero. The servo loop acts to maintain the input power level to the mixer as the power level at IF\_IN changes. Ideally, a detector with an output voltage range of 0.1V to 2.4V DC is recommended, but the MAX2091 can operate with any detector whose output ranges from 0 to 2.5V DC (with the coupling network at IF\_OUT already taken into account).

When used in conjunction with the MAX2092 RF VGA, a nominal RF signal level of approximately -3dBm output from the MAX2091 is recommended. With this specific level setting, the complete MAX2091 and MAX2092 cascade can yield a constant RF output power of at least -20.5dBm to +5dBm over an IF input power range of

-25dBm to +5dBm. See [Figure 1](#) for details. Contact the factory for additional details surrounding Maxim's MAX2091 and MAX2092 reference design.

### Control Inputs

The MAX2091 has four control inputs: CTRL1, CTRL2, ALM\_THRES, and PLVLSSET. VCC must be present before voltages are applied to these pins. In cases where this is not possible, a 200Ω resistor must be included in series with the control inputs to limit on-chip ESD diode conduction. CTRL1 and CTRL2 are 3V logic controls and cannot be driven from 5V logic. In the case where no logic control is available and a logic-high is required, a voltage-divider can be used from the 5V VCC supply to produce the 3V logic-high.

### VGA Output Pad

As shown in [Figure 1](#) and the [Typical Application Circuit](#), provisions have been made to allow for the placement of a Tee attenuator between the VGA output and the mixer input. A default value of 2.5dB is used within the application circuit, although any desired value can be chosen. Alternatively, the attenuator can be replaced by a simple equalizer circuit if additional frequency gain-slope correction is desired over wider bands of operation.

# MAX2091

## 50MHz to 500MHz Analog VGA, 1735MHz to 1935MHz Upconverting Mixer with Image Filtering, Threshold Alarm Circuit, and Error Amplifier for Level Control

Additionally, a lowpass filter can be used between the VGA output and the mixer input to reduce possible image noise (RF + LO) at the VGA output from being downconverted to the mixer output. Contact the factory for details.

### Alarm Operation

The alarm output (ALM) remains in a logic-high state, while DET\_IN is above 1.35V nominally. ALM\_THRES has 135k $\Omega$  input resistance and is set internally to 1.35V (typ), such that ALM triggers when DET\_IN is below 1.35V. Alternatively, the voltage on ALM\_THRES can be externally driven to allow alternative power-level trip points. The ALM comparator has a typical hysteresis of 29mV.

### Mixer LO Inputs

The mixer is designed to operate with LO+ signal levels between -10dBm and -4dBm and with LO- grounded. In cases where V<sub>CC</sub> is applied to the MAX2091 and LO+ is below approximately -15dBm, the mixer's LO driver could produce undesired spurious at RF\_OUT. In such a case, applying -10dBm to -4dBm to LO+ returns the mixer to proper operation. To eliminate the possibility of spurious at RF\_OUT with invalid LO+ signal levels, power-down mode can be asserted (CTRL1 = CTRL2 = logic 0) to disable RF\_OUT.

### Layout Considerations

The pin configuration of the MAX2091 is optimized to facilitate a very compact physical layout of the device and its associated discrete components. The exposed pad

**Table 2. Typical Application Circuit Component Values**

COMPONENT	MODE OF OPERATION		VALUE	SIZE	VENDOR	DESCRIPTION
	VGA/MIXER ONLY	CLOSED-ALC				
C1, C5, C7	✓	✓	1000pF	0402	Murata	C0G Dielectric
C2, C3, C10, C12	✓	✓	0.01 $\mu$ F	0402	Murata	X7R Dielectric
C4, C11	✓	✓	100pF	0402	Murata	C0G Dielectric
C8		✓	100nF	0603	Murata	X7R Dielectric
C9		✓	820pF	0402	Murata	C0G Dielectric
C14*			Do Not Install	0402		
C15	✓	✓	1 $\mu$ F	0603	Murata	X7R Dielectric
C16		✓	0.01 $\mu$ F	0402	Murata	X7R Dielectric
L1	✓	✓	330nH	0603	Coilcraft	Ferrite LS series 5% Tolerance
R1	✓	✓	1.78k $\Omega$	0402	Panasonic	1% Tolerance
R2, R3**	✓	✓	7.1 $\Omega$	0402	Panasonic	1% Tolerance
R4**	✓	✓	174 $\Omega$	0402	Panasonic	1% Tolerance
R5		✓	150 $\Omega$	0402	Panasonic	1% Tolerance
R7		✓	24k $\Omega$	0402	Panasonic	5% Tolerance
R11*	✓	✓	0 $\Omega$	0402	Panasonic	1% Tolerance
U1	✓	✓	—	20-pin TQFN (5mm x 5mm)	Maxim	MAX2091ETP+

**Note:** The checkmarks in the Mode of Operation columns indicate that the component is used within each respective application.

\*C14 and R11 form an optional lowpass network to filter out potential noise from the external PLVLSET control source.

\*\*R2–R4 form an optional 2.5dB attenuator pad.

# MAX2091

## 50MHz to 500MHz Analog VGA, 1735MHz to 1935MHz Upconverting Mixer with Image Filtering, Threshold Alarm Circuit, and Error Amplifier for Level Control

(EP) of the MAX2091's 20-pin TQFN package provides a low thermal-resistance path to the die. It is important that the PCB on which the MAX2091 is mounted be designed to conduct heat from the EP. In addition, provide the EP with a low-inductance path to electrical ground. The EP

must be soldered to a ground plane on the PCB, either directly or through an array of plated via holes.

### Typical Application Circuit

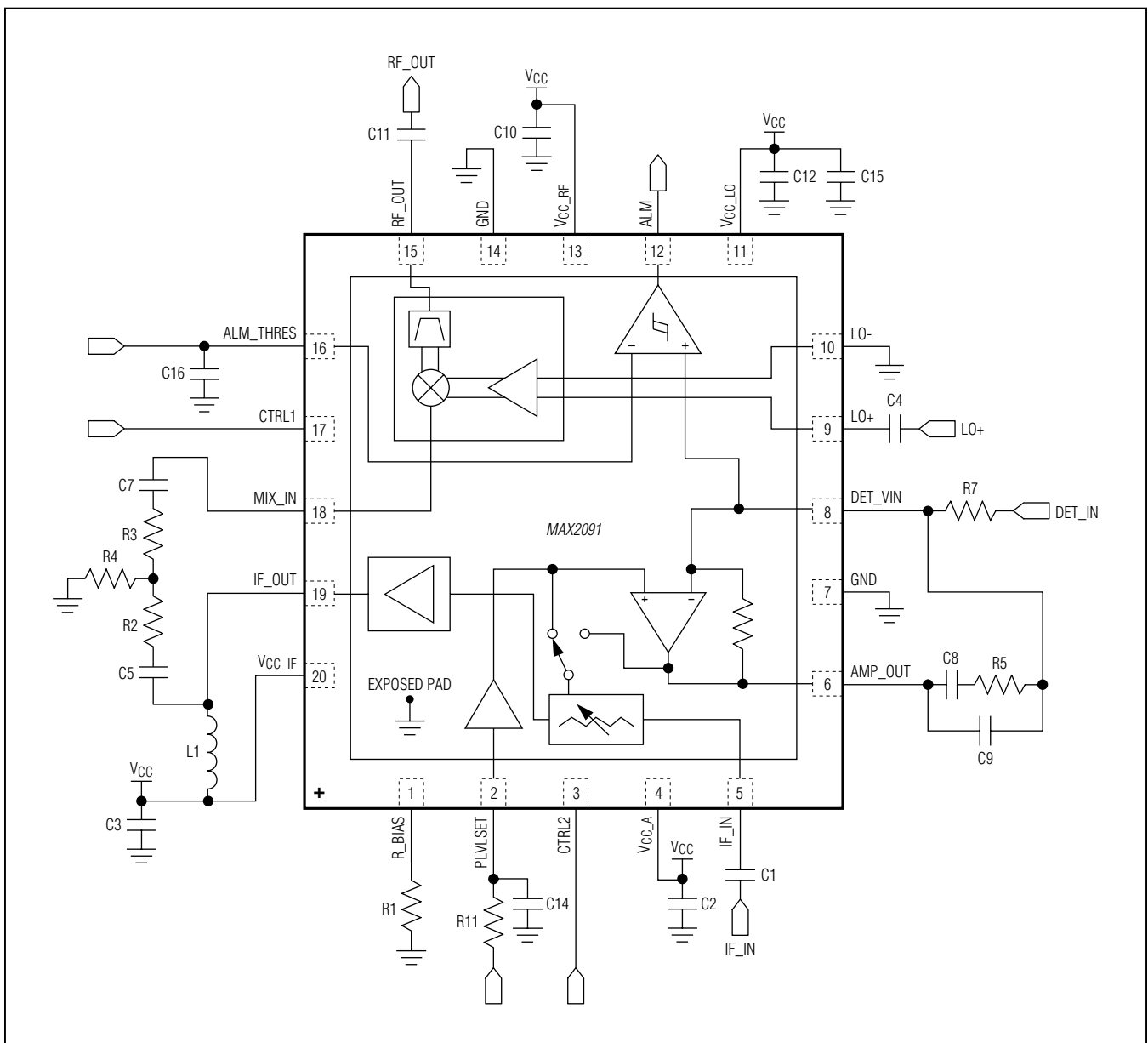

# MAX2091

## 50MHz to 500MHz Analog VGA, 1735MHz to 1935MHz Upconverting Mixer with Image Filtering, Threshold Alarm Circuit, and Error Amplifier for Level Control

### Ordering Information

PART	TEMP RANGE	PIN-PACKAGE
MAX2091ETP+	-40°C to +95°C	20 TQFN-EP*
MAX2091ETP+T	-40°C to +95°C	20 TQFN-EP*
MAX2091BETP+**	-40°C to +95°C	20 TQFN-EP*
MAX2091BETP+T**	-40°C to +95°C	20 TQFN-EP*

+ Denotes a lead(Pb)-free/RoHS-compliant package.

\*EP = Exposed pad.

\*\*Future product—contact factory for samples.

T = Tape and reel.

### Chip Information

PROCESS: SiGe BiCMOS

### Package Information

For the latest package outline information and land patterns (footprints), go to [www.maximintegrated.com/packages](http://www.maximintegrated.com/packages). Note that a "+", "#", or "-" in the package code indicates RoHS status only. Package drawings may show a different suffix character, but the drawing pertains to the package regardless of RoHS status.

PACKAGE TYPE	PACKAGE CODE	OUTLINE NO.	LAND PATTERN NO.
20 TQFN-EP	T2055-5	<a href="#">21-0140</a>	<a href="#">90-0010</a>

# MAX2091

## 50MHz to 500MHz Analog VGA, 1735MHz to 1935MHz Upconverting Mixer with Image Filtering, Threshold Alarm Circuit, and Error Amplifier for Level Control

### Revision History

REVISION NUMBER	REVISION DATE	DESCRIPTION	PAGES CHANGED
0	7/12	Initial release	—
1	5/15	Removed military reference from <i>Applications</i>	1



Maxim Integrated cannot assume responsibility for use of any circuitry other than circuitry entirely embodied in a Maxim Integrated product. No circuit patent licenses are implied. Maxim Integrated reserves the right to change the circuitry and specifications without notice at any time. The parametric values (min and max limits) shown in the Electrical Characteristics table are guaranteed. Other parametric values quoted in this data sheet are provided for guidance.

**Maxim Integrated 160 Rio Robles, San Jose, CA 95134 USA 1-408-601-1000**

29