

ZB5AG2

Harmony XB5, Key switch selector head, plastic, black, Ø22, key n°455, 2 positions, stay put à corriger



Main

Range of Product	Harmony XB5 Harmony XALF
Product or Component Type	Head for key selector switch
Device short name	ZB5
Bezel material	Dark grey plastic
Mounting diameter	0.87 in (22 mm)
Head type	Standard
Sale per indivisible quantity	1
Shape of signaling unit head	Round
Type of operator	Stay put
Operator profile	Black key switch
Operator position information	2 positions 90°
Type of Keylock	Ronis 455
Key withdrawal position	Left

Complementary

CAD overall width	1.14 in (29 mm)
CAD overall height	1.14 in (29 mm)
CAD overall depth	2.83 in (72 mm)
Net Weight	0.13 lb(US) (0.057 kg)
Mechanical durability	1000000 cycles
Station name	XALD 1...5 cut-outs XALK 2...5 cut-outs
Electrical composition code	C4 6 single and double front mounting C5 5 single front mounting C6 5 single and double front mounting C7 4 single front mounting C8 4 single and double front mounting C11 3 single front mounting C3 6 single front mounting SF1 3 single front mounting SR1 3 single rear mounting C15 1 single front mounting
Device presentation	Basic element

Environment

Protective treatment	TH
Ambient Air Temperature for Storage	-40...158 °F (-40...70 °C)
Ambient air temperature for operation	-40...158 °F (-40...70 °C)
Overvoltage category	Class II IEC 60536
IP degree of protection	IP66 IEC 60529 IP67 IP69 IP69K
NEMA degree of protection	NEMA 13 NEMA 4X

Resistance to high pressure washer	1015.26 psi (7000000 Pa) 131 °F (55 °C) 0.1 m
IK degree of protection	IK06 IEC 50102
Standards	UL 508 EN/IEC 60947-5-1 EN/IEC 60947-1 CSA C22.2 No 14 JIS C8201-5-1 EN/IEC 60947-5-4 JIS C8201-1
Product Certifications	CSA BV UL Listed DNV GL LROS (Lloyds register of shipping)
Vibration resistance	5 gn 2...500 Hz)IEC 60068-2-6
Shock resistance	30 gn 18 ms) half sine wave acceleration IEC 60068-2-27 50 gn 11 ms) half sine wave acceleration IEC 60068-2-27

Ordering and shipping details

Category	22467 - PUSHBUTTONS,22MM(PLASTIC) NEW
Discount Schedule	CS2
GTIN	3389110905809
Nbr. of units in pkg.	1
Package weight(Lbs)	2.36 oz (67 g)
Returnability	Yes
Country of origin	FR

Packing Units

Unit Type of Package 1	PCE
Package 1 Height	3.46 in (8.8 cm)
Package 1 width	2.05 in (5.2 cm)
Package 1 Length	1.30 in (3.3 cm)
Unit Type of Package 2	BB1
Number of Units in Package 2	5
Package 2 Weight	11.75 oz (333 g)
Package 2 Height	3.46 in (8.8 cm)
Package 2 width	2.05 in (5.2 cm)
Package 2 Length	10.43 in (26.5 cm)
Unit Type of Package 3	S03
Number of Units in Package 3	150
Package 3 Weight	23.12 lb(US) (10.486 kg)
Package 3 Height	11.81 in (30 cm)
Package 3 width	11.81 in (30 cm)
Package 3 Length	15.75 in (40 cm)

Offer Sustainability

Sustainable offer status	Green Premium product
California proposition 65	WARNING: This product can expose you to chemicals including: Lead and lead compounds, which is known to the State of California to cause cancer and birth defects or other reproductive harm. For more information go to www.P65Warnings.ca.gov
REACH Regulation	REACH Declaration
EU RoHS Directive	Pro-active compliance (Product out of EU RoHS legal scope) EU RoHS Declaration
Mercury free	Yes
RoHS exemption information	Yes
China RoHS Regulation	China RoHS Declaration

Environmental Disclosure	Product Environmental Profile
Circularity Profile	End Of Life Information

Contractual warranty

Warranty	18 months
----------	-----------

Dimensions

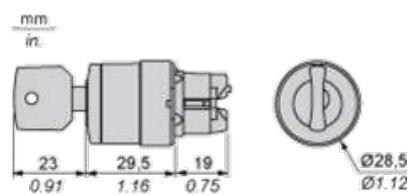

Panel Cut-out for Pushbuttons, Switches and Pilot Lights (Finished Holes, Ready for Installation)

Connection by Screw Clamp Terminals or Plug-in Connectors or on Printed Circuit Board



- (1) Diameter on finished panel or support
- (2) For selector switches and Emergency stop buttons, use of an anti-rotation plate type ZB5AZ902 is recommended.
- (3) $\varnothing 22.5$ mm recommended ($\varnothing 22.3 \text{ }_0^{+0.4}$) / $\varnothing 0.89$ in. recommended ($\varnothing 0.88 \text{ in. }_0^{+0.016}$)

Connections	a in mm	a in in.	b in mm	b in in.
By screw clamp terminals or plug-in connector	40	1.57	30	1.18
By Faston connectors	45	1.77	32	1.26
On printed circuit board	30	1.18	30	1.18

Detail of Lug Recess

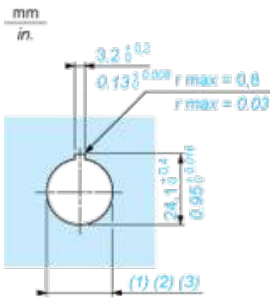

- (1) Diameter on finished panel or support
- (2) For selector switches and Emergency stop buttons, use of an anti-rotation plate type ZB5AZ902 is recommended.
- (3) $\varnothing 22.5$ mm recommended ($\varnothing 22.3 \text{ }_0^{+0.4}$) / $\varnothing 0.89$ in. recommended ($\varnothing 0.88 \text{ in. }_0^{+0.016}$)

Pushbuttons, Switches and Pilot Lights for Printed Circuit Board Connection

Panel Cut-outs (Viewed from Installer's Side)

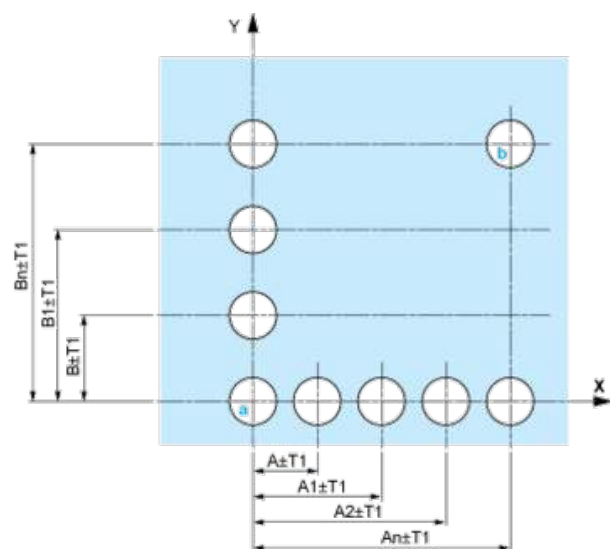

A: 30 mm min. / 1.18 in. min.

B: 40 mm min. / 1.57 in. min.

Printed Circuit Board Cut-outs (Viewed from Electrical Block Side)

Dimensions in mm

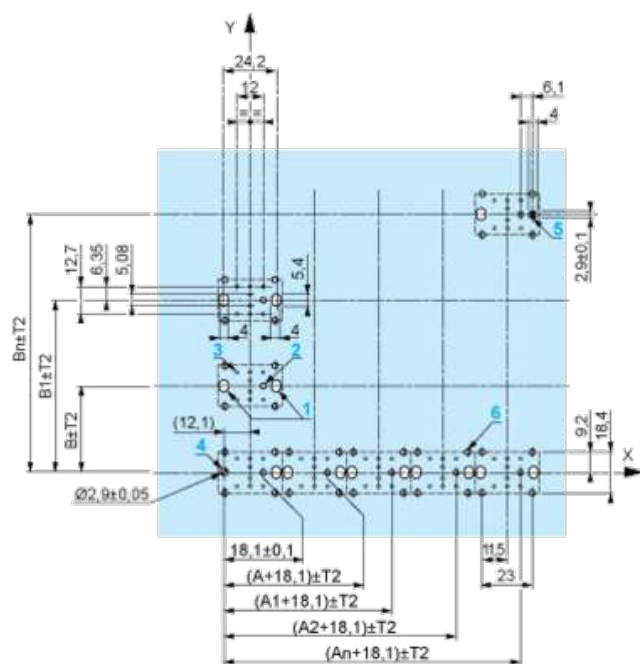

A: 30 mm min.

B: 40 mm min.

Dimensions in in.



A: 1.18 in. min.

B: 1.57 in. min.

General Tolerances of the Panel and Printed Circuit Board

The cumulative tolerance must not exceed 0.3 mm / 0.012 in.: $T1 + T2 = 0.3 \text{ mm max.}$

Installation Precautions

- Minimum thickness of circuit board: 1.6 mm / 0.06 in.
- Cut-out diameter: 22.4 mm \pm 0.1 / 0.88 in. \pm 0.004
- Orientation of body/fixing collar ZB5AZ009: $\pm 2^\circ 30'$ (excluding cut-outs marked a and b).
- Tightening torque of screws ZBZ006: 0.6 N.m (5.3 lbf.in) max.
- Allow for one ZB5AZ079 fixing collar/pillar and its fixing screws:
 - every 90 mm / 3.54 in. horizontally (X), and 120 mm / 4.72 in. vertically (Y).
 - with each selector switch head (ZB5AD*, ZB5AJ*, ZB5AG*).

The fixing centers marked a and b are diagonally opposed and must align with those marked 4 and 5.

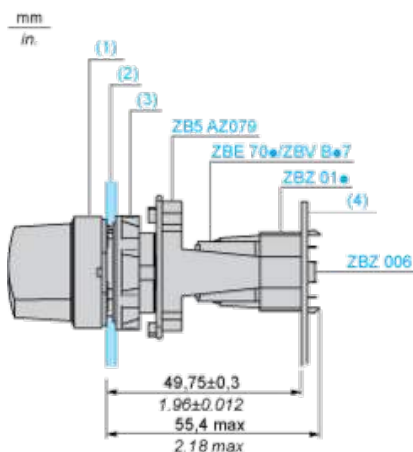

(1) Head ZB5AD*

(2) Panel

(3) Nut

(4) Printed circuit board

Mounting of Adapter (Socket) ZBZ01•

- 1 2 elongated holes for ZBZ006 screw access
- 2 1 hole \varnothing 2.4 mm \pm 0.05 / 0.09 in. \pm 0.002 for centring adapter ZBZ01•
- 3 8 \times \varnothing 1.2 mm / 0.05 in. holes
- 4 1 hole \varnothing 2.9 mm \pm 0.05 / 0.11 in. \pm 0.002, for aligning the printed circuit board (with cut-out marked a)
- 5 1 elongated hole for aligning the printed circuit board (with cut-out marked b)
- 6 4 holes \varnothing 2.4 mm / 0.09 in. for clipping in adapter ZBZ01•

Dimensions An + 18.1 relate to the \varnothing 2.4 mm \pm 0.05 / 0.09 in. \pm 0.002 holes for centring adapter ZBZ01•.

Electrical Composition Corresponding to Code C4

Electrical Composition Corresponding to Code C5

Electrical Composition Corresponding to Code C6

Electrical Composition Corresponding to Code C7

Electrical Composition Corresponding to Code C8

Electrical Composition Corresponding to Code C3

Electrical Composition Corresponding to Codes C9, C11, SF1 and SR1

Legend

Single contact

Double contact

Light block





Possible location



Sequence of Contacts Fitted to 2-position Selector Switch Body

Position 315°



Push	Position	Top			
Bottom					
Location		Left	Centre	Right	
State		0	0	0	
Contacts	N/O		open	open	open
N/C		closed	closed	closed	

Position 45°



Push	Position	Top			
Bottom	<input type="checkbox"/>				
Location		Left	Centre	Right	
State		1	1	1	
Contacts	N/O		closed	closed	closed
N/C		open	open	open	