

C3D30065D

Silicon Carbide Schottky Diode

Z-REC[®] RECTIFIER

V_{RRM}	=	650 V
$I_F (T_c=135^\circ\text{C})$	=	36 A**
Q_c	=	89 nC**

Features

- 650 Volt Schottky Rectifier
- Zero Reverse Recovery Current
- Zero Forward Recovery Voltage
- High-Frequency Operation
- Temperature-Independent Switching Behavior
- Extremely Fast Switching
- Positive Temperature Coefficient on V_F

Benefits

- Replace Bipolar with Unipolar Rectifiers
- Essentially No Switching Losses
- Higher Efficiency
- Reduction of Heat Sink Requirements
- Parallel Devices Without Thermal Runaway

Applications

- Switch Mode Power Supplies (SMPS)
- Boost diodes in PFC or DC/DC stages
- Free Wheeling Diodes in Inverter stages
- AC/DC converters

Maximum Ratings ($T_c=25^\circ\text{C}$ unless otherwise specified)

Symbol	Parameter	Value		Test Conditions	Note
V_{RRM}	Repetitive Peak Reverse Voltage	650	V		
V_{RSM}	Surge Peak Reverse Voltage	650	V		
V_{DC}	DC Blocking Voltage	650	V		
I_F	Continuous Forward Current (Per Leg/Device)	39/78 18/36 15/30	A	$T_c=25^\circ\text{C}$ $T_c=135^\circ\text{C}$ $T_c=145^\circ\text{C}$	Fig. 3
I_{FRM}	Repetitive Peak Forward Surge Current	66* 46*	A	$T_c=25^\circ\text{C}, t_p=10\text{ ms}$, Half Sine Pulse $T_c=110^\circ\text{C}, t_p=10\text{ ms}$, Half Sine Pulse	
I_{FSM}	Non-Repetitive Peak Forward Surge Current	162 150	A	$T_c=25^\circ\text{C}, t_p=10\text{ ms}$, Half Sine Pulse $T_c=110^\circ\text{C}, t_p=10\text{ ms}$, Half Sine Pulse	Fig. 8
I_{FMax}	Non-Repetitive Peak Forward Current	1400 1200	A	$T_c=25^\circ\text{C}, t_p=10\text{ }\mu\text{s}$, Pulse $T_c=110^\circ\text{C}, t_p=10\text{ }\mu\text{s}$, Pulse	Fig. 8
P_{tot}	Power Dissipation(Per Leg/Device)	150 65	W	$T_c=25^\circ\text{C}$ $T_c=110^\circ\text{C}$	Fig. 4
dV/dt	Diode dV/dt ruggedness	200	V/ns	$V_R=0-600\text{V}$	
$\int i^2 dt$	i^2t value	131* 112.5*	A ² s	$T_c=25^\circ\text{C}, t_p=10\text{ ms}$ $T_c=110^\circ\text{C}, t_p=10\text{ ms}$	
T_J, T_{stg}	Operating Junction and Storage Temperature	-55 to +175	°C		
	TO-247 Mounting Torque	1 8.8	Nm lbf-in	M3 Screw 6-32 Screw	

* Per Leg, ** Per Device

Package



TO-247-3

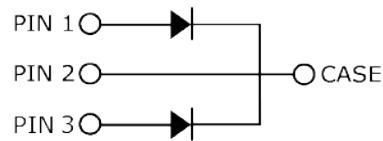

Part Number	Package	Marking
C3D30065D	TO-247-3	C3D30065

Electrical Characteristics (Per Leg)

Symbol	Parameter	Typ.	Max.	Unit	Test Conditions	Note
V_F	Forward Voltage	1.45 2.0	1.8 2.4	V	$I_F = 16\text{ A}$ $T_J = 25^\circ\text{C}$ $I_F = 16\text{ A}$ $T_J = 175^\circ\text{C}$	Fig. 1
I_R	Reverse Current	18.5 38.5	95 378	μA	$V_R = 650\text{ V}$ $T_J = 25^\circ\text{C}$ $V_R = 650\text{ V}$ $T_J = 175^\circ\text{C}$	Fig. 2
Q_C	Total Capacitive Charge	44.5		nC	$V_R = 400\text{ V}$, $I_F = 16\text{ A}$ $di/dt = 500\text{ A}/\mu\text{s}$ $T_J = 25^\circ\text{C}$	Fig. 5
C	Total Capacitance	877.5 80 64		pF	$V_R = 0\text{ V}$, $T_J = 25^\circ\text{C}$, $f = 1\text{ MHz}$ $V_R = 200\text{ V}$, $T_J = 25^\circ\text{C}$, $f = 1\text{ MHz}$ $V_R = 400\text{ V}$, $T_J = 25^\circ\text{C}$, $f = 1\text{ MHz}$	Fig. 6
E_C	Capacitance Stored Energy	6.2		μJ	$V_R = 400\text{ V}$	Fig. 7

Note: This is a majority carrier diode, so there is no reverse recovery charge.

Thermal Characteristics

Symbol	Parameter	Typ.	Unit	Note
$R_{\theta JC}$	Thermal Resistance from Junction to Case	1* 0.5**	$^\circ\text{C}/\text{W}$	Fig. 9

* Per Leg, ** Per Device

Typical Performance (Per Leg)

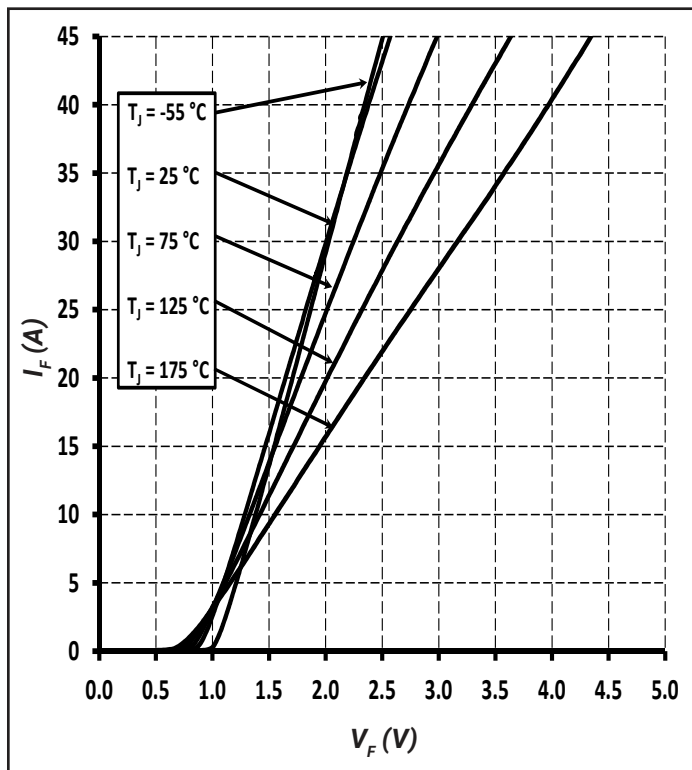

Figure 1. Forward Characteristics

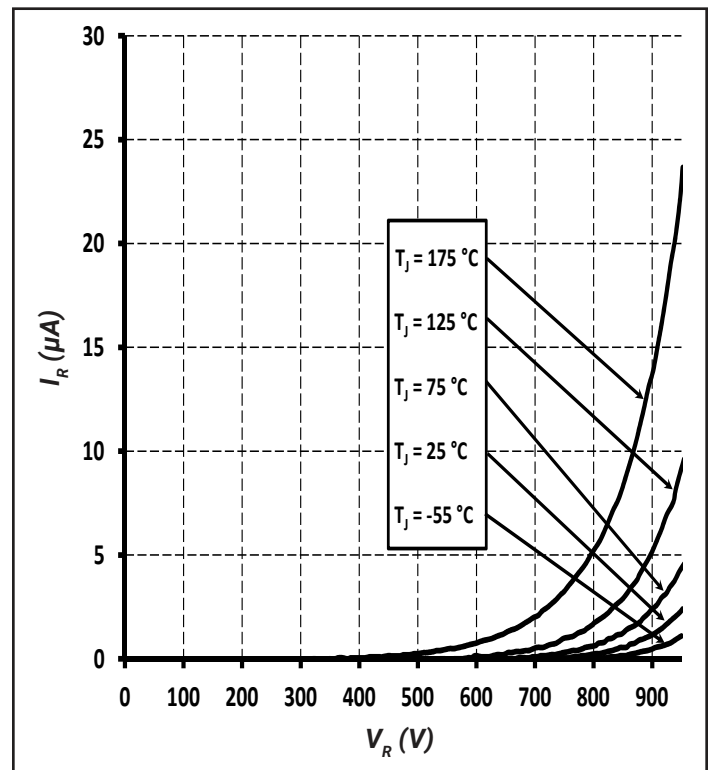

Figure 2. Reverse Characteristics

Typical Performance (Per Leg)

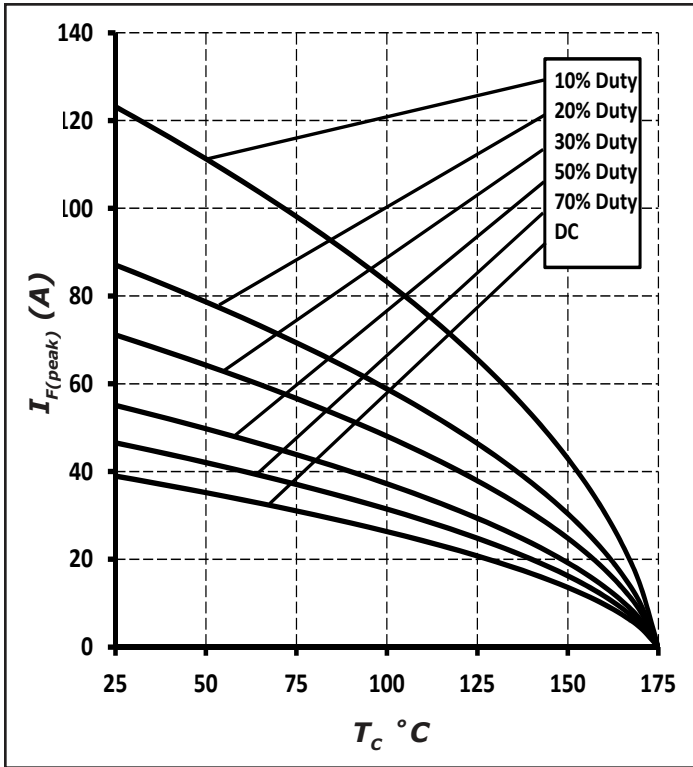

Figure 3. Current Derating

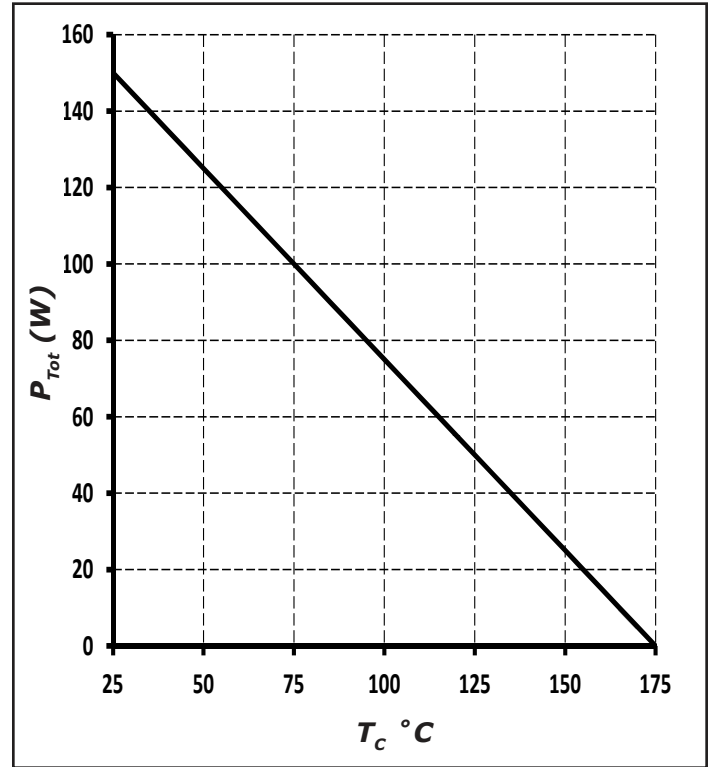

Figure 4. Power Derating

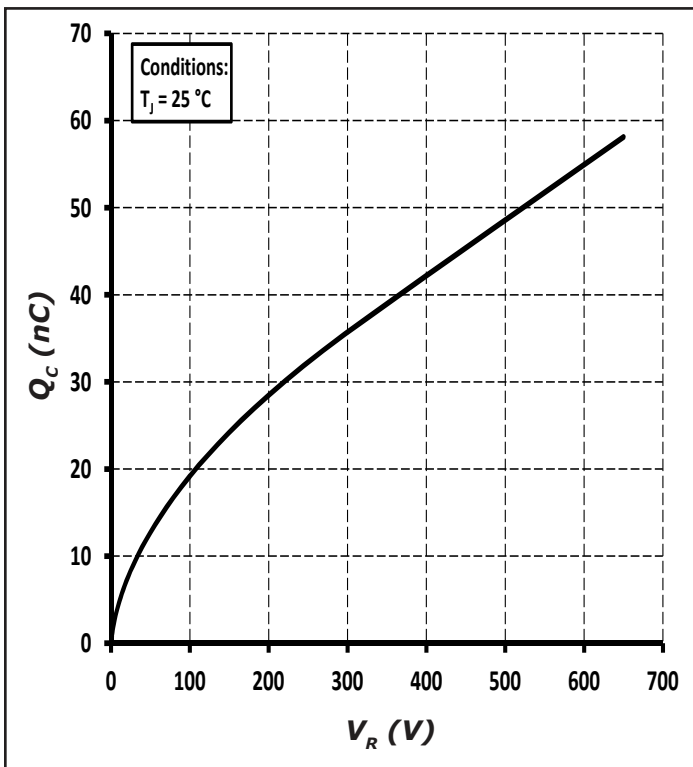

Figure 5. Total Capacitance Charge vs. Reverse Voltage

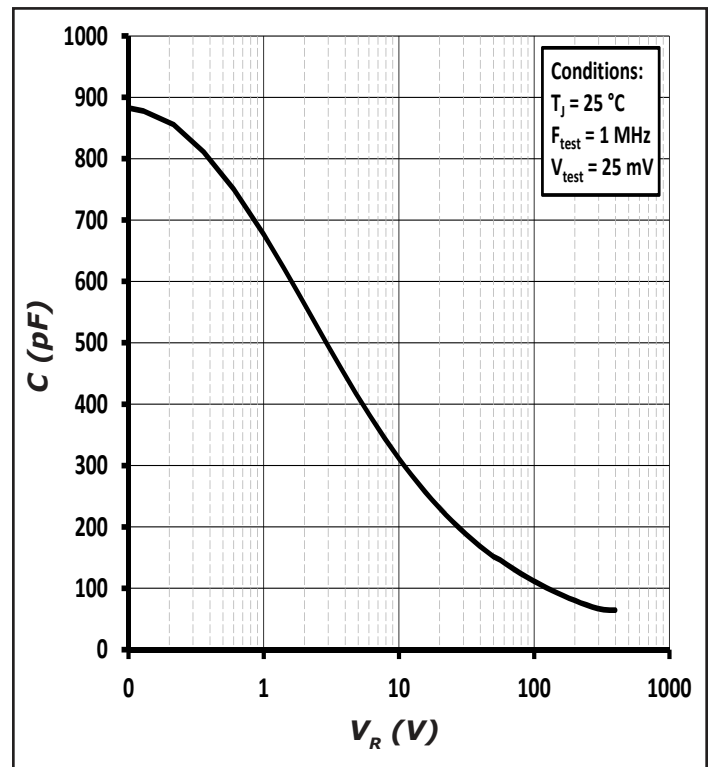

Figure 6. Capacitance vs. Reverse Voltage

Typical Performance (Per Leg)

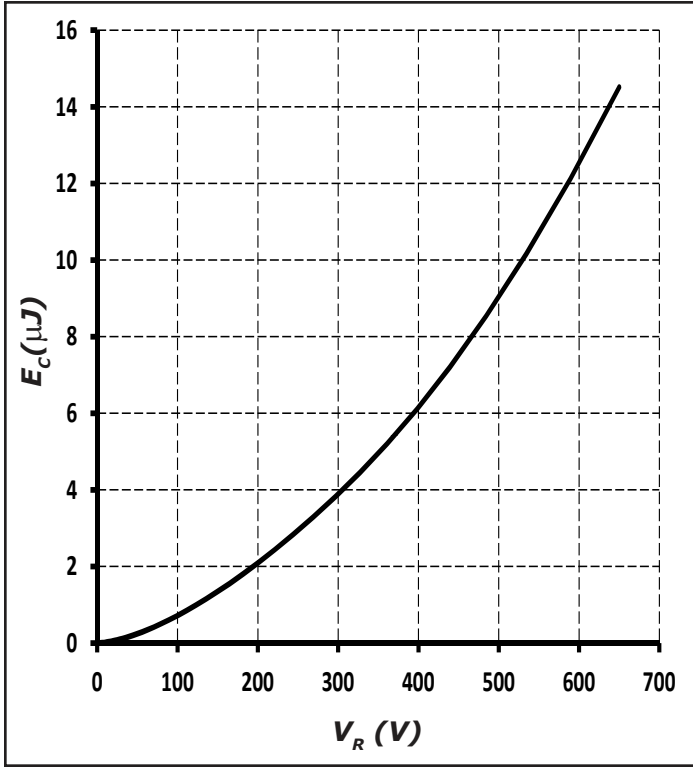

Figure 7. Capacitance Stored Energy

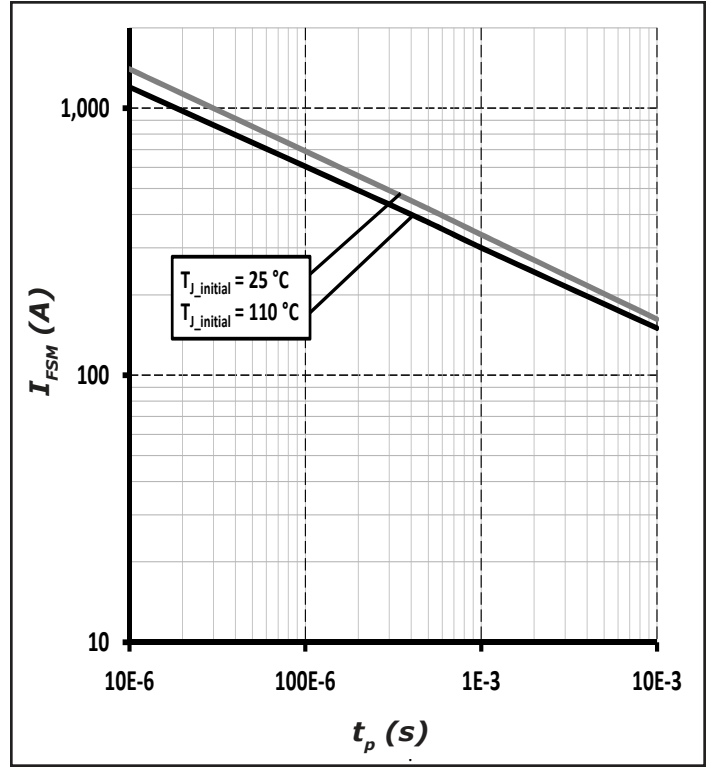

Figure 8. Non-repetitive peak forward surge current versus pulse duration (sinusoidal waveform)

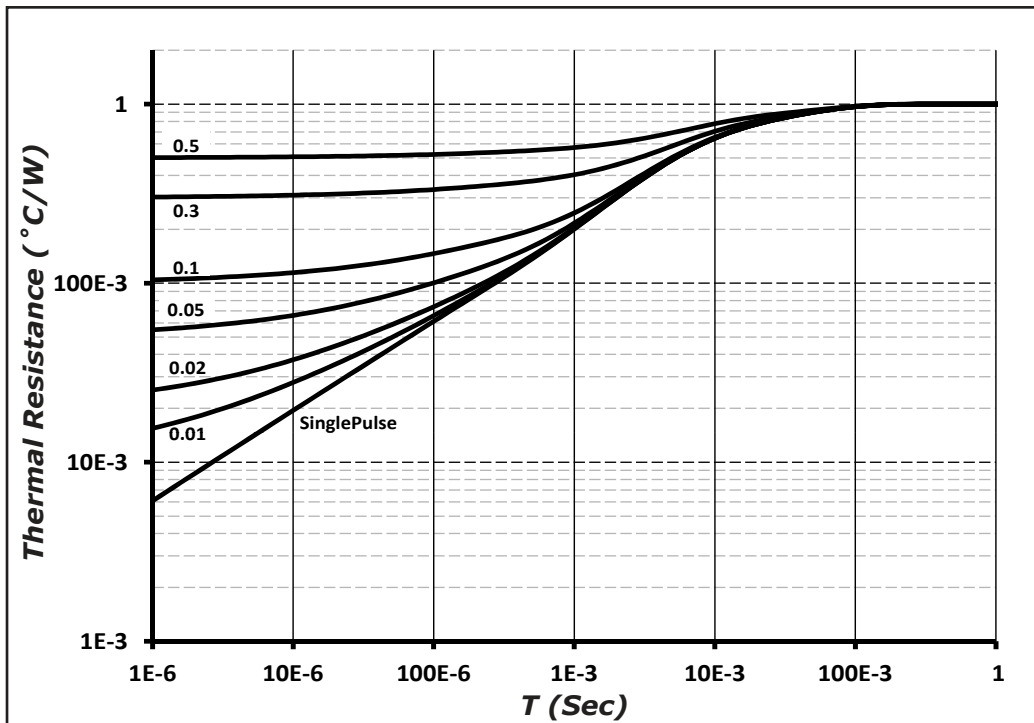
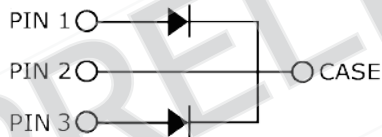
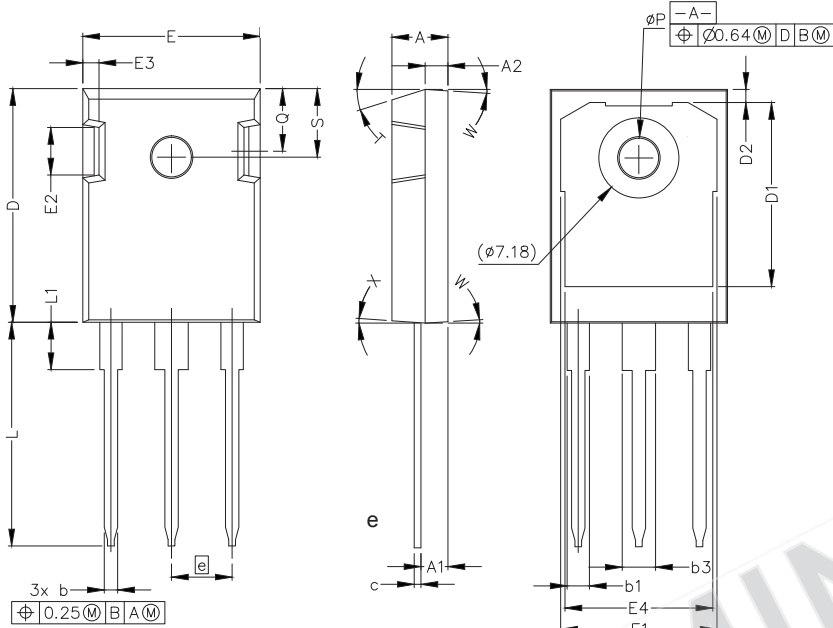

Figure 9. Transient Thermal Impedance

Package Dimensions

Package TO-247-3



POS	Inches		Millimeters	
	Min	Max	Min	Max
A	.190	.205	4.83	5.21
A1	.090	.100	2.29	2.54
A2	.075	.085	1.91	2.16
b	.042	.052	1.07	1.33
b1	.075	.095	1.91	2.41
b3	.113	.133	2.87	3.38
c	.022	.027	0.55	0.68
D	.819	.831	20.80	21.10
D1	.640	.695	16.25	17.65
D2	.037	.049	0.95	1.25
E	.620	.635	15.75	16.13
E1	.516	.557	13.10	14.15
E2	.145	.201	3.68	5.10
E3	.039	.075	1.00	1.90
E4	.487	.529	12.38	13.43
e	.214 BSC		5.44 BSC	
L	.780	.800	19.81	20.32
L1	.161	.173	4.10	4.40
N	3			
ØP	.138	.144	3.51	3.65
Q	.216	.236	5.49	6.00
S	.238	.248	6.04	6.30
T	17.5° REF			
W	3.5° REF			
X	4° REF			

Recommended Solder Pad Layout

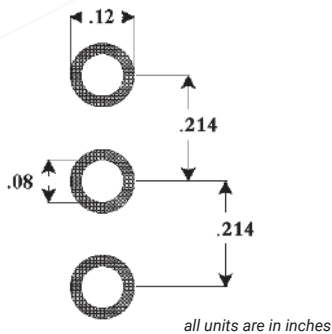

TO-247-3

Part Number	Package	Marking
C3D30065D	TO-247-3	C3D30065

Note: Recommended soldering profiles can be found in the applications note here:
http://www.wolfspeed.com/power_app_notes/soldering



Diode Model (Per Leg)

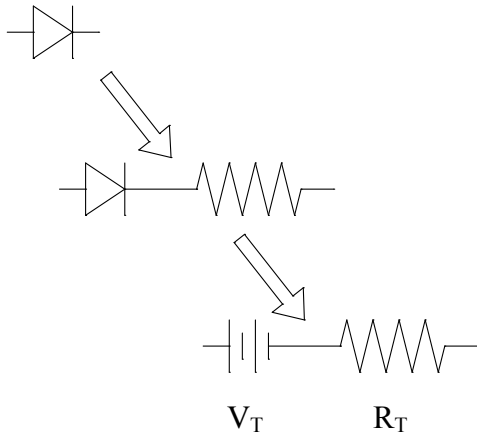

$$V_{f_T} = V_T + I_f * R_T$$

$$V_T = 0.94 + (T_J * -1.0 * 10^{-3})$$

$$R_T = 0.027 + (T_J * 2.8 * 10^{-4})$$

Note: T_J = Diode Junction Temperature In Degrees Celsius, valid from 25°C to 175°C

Notes

- **RoHS Compliance**

The levels of RoHS restricted materials in this product are below the maximum concentration values (also referred to as the threshold limits) permitted for such substances, or are used in an exempted application, in accordance with EU Directive 2011/65/EC (RoHS2), as implemented January 2, 2013. RoHS Declarations for this product can be obtained from your Wolfspeed representative or from the Product Ecology section of our website at <http://www.wolfspeed.com/Power/Tools-and-Support/Product-Ecology>.

- **REACH Compliance**

REACH substances of high concern (SVHCs) information is available for this product. Since the European Chemical Agency (ECHA) has published notice of their intent to frequently revise the SVHC listing for the foreseeable future, please contact a Cree representative to insure you get the most up-to-date REACH SVHC Declaration. REACH banned substance information (REACH Article 67) is also available upon request.

- This product has not been designed or tested for use in, and is not intended for use in, applications implanted into the human body nor in applications in which failure of the product could lead to death, personal injury or property damage, including but not limited to equipment used in the operation of nuclear facilities, life-support machines, cardiac defibrillators or similar emergency medical equipment, aircraft navigation or communication or control systems, or air traffic control systems.

Related Links

- Cree SiC Schottky diode portfolio: <http://www.wolfspeed.com/Power/Products#SiCSchottkyDiodes>
- Schottky diode Spice models: <http://www.wolfspeed.com/power/tools-and-support/DIODE-model-request2>
- SiC MOSFET and diode reference designs: <http://go.pardot.com/l/101562/2015-07-31/349i>