

Click to
ORDER
samples

AMDG-JZ

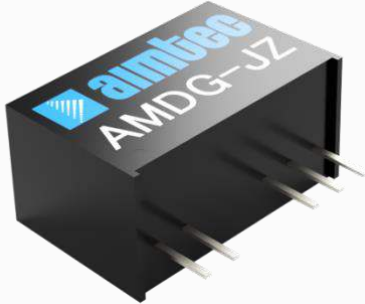

SIP7

The new AMDG-JZ is an ultra-wide input DC/DC converter that has a dual isolated output channel, which leads to improved reliability and performance. This series will offer many benefits to your design if it requires several voltage supply rails being supplied by one component.

This series offers great operating temperatures, from -40°C to +105°C with full power up to 85°C. It also features an isolation of 5000VAC for improved reliability and system safety. Furthermore, a high MTBF of 3,500,000h, output short circuit protection (OSCP) come standard.

The AMDG-JZ is great for distributed power supply systems, industrial controls, power grid, instruments and communications applications.

Features

- Operating Temp: -40 °C to +105 °C
- High isolation voltage: 5000VAC
- Low ripple & noise, 50mV (p-p), typ.
- SIP7 package
- Output short circuit protection

Summary

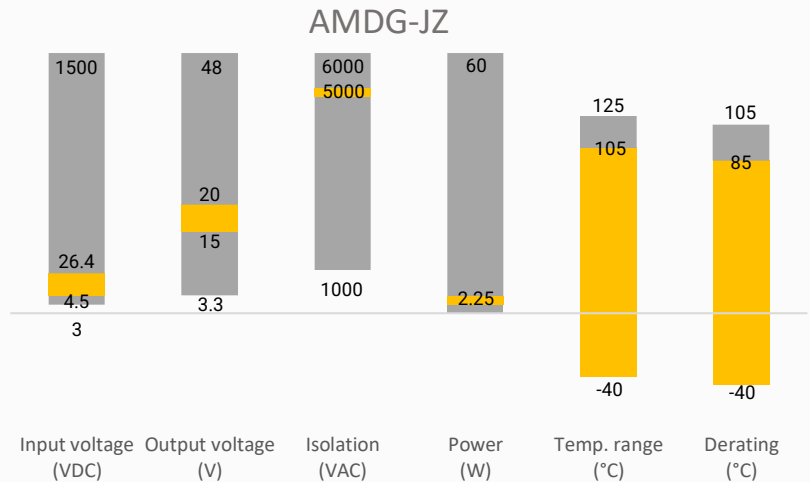

Training



Product Training Video
(click to open)



Press Release

Coming Soon!

Application Notes

Applications



Power Grid



Industrial



Telecom



Instrumentation

Models & Specifications

Dual Output									
Model	Input Voltage (VDC)	Output Voltage (VDC)		Input Current Max (mA)		Output Current Max (mA)		Maximum Capacitive Load (μ F)	Efficiency (%) Full Load Typ.
		Vo1	Vo2	No Load	Full Load	Io1	Io2		
AMDG-051505A50JZ	5 (4.5-5.5)	15	-5	20	343	80	-40	1000	82
AMDG-051803A50JZ	5 (4.5-5.5)	18	-3.5	20	415	80	-80	680	82
AMDG-052004A50JZ	5 (4.5-5.5)	20	-4	18	407	80	-40	470	82
AMDG-121502A50JZ	12 (10.8-13.2)	15	-2.5	8	167	100	-100	2200	87
AMDG-121504A50JZ	12 (10.8-13.2)	15	-4	8	215	120	-120	2200	87
AMDG-121803A50JZ	12 (10.8-13.2)	18	-3	8	200	100	-100	1000	87
AMDG-122005A50JZ	12 (10.8-13.2)	20	-5	14	213	90	-90	470	87
AMDG-151504A50JZ	15 (13.5-16.5)	15	-4	8	171	120	-120	2200	87
AMDG-152005A50JZ	15 (13.5-16.5)	20	-5	8	167	90	-90	2200	87
AMDG-241504A50JZ	24 (21.6-26.4)	15	-4	10	131	120	-120	2200	82
AMDG-242005A50JZ	24 (21.6-26.4)	20	-5	11	129	90	-90	2200	81

Input Specification				
Parameters	Conditions	Typical	Maximum	Units
Absolute maximum rating	5Vin,60ms,max	> -0.7	9	VDC
	12Vin,60ms,max	> -0.7	18	VDC
	15Vin,60ms,max	> -0.7	21	VDC
	24Vin,60ms,max	> -0.7	30	VDC
Filter	Capacitance Filter			

Isolation Specification				
Parameters	Conditions	Typical	Maximum	Units
Tested isolation voltage	Input / output, 60 sec, \leq 1mA	\geq 5000		VAC
Continuous barrier withstand voltage	Input / output, according to 61800-5-1	\geq 1700		V
CMTI	Input / output	\pm 200		kV/ μ s
Resistance	500VDC	\geq 1000		M Ω
Capacitance	100kHz/ 0.1V	3.5	5	pF

Output Specification				
Parameters	Conditions	Typical	Maximum	Units
Voltage accuracy	10% -100% load, See Typical Characteristic			
Line regulation	LL – HL, 100% load, 5Vin	\pm 1.1	\pm 1.4	%
	LL – HL, 100% load, Others	\pm 1.1	\pm 1.5	%
Load regulation	10% - 100%, Vo1/Vo2, 5Vin	8/10	15/15	%
	10% - 100%, Vo1/Vo2, Others	6/8	15/15	%

Output voltage	AMDG-051505A50JZ, 100% load, Vo1/Vo2	15.3/-4.7	16.05/-4.95	VDC
	AMDG-051803A50JZ, 100% load, Vo1/Vo2	17.64/-3.3	18.54/-3.67	VDC
	AMDG-052004A50JZ, 100% load, Vo1/Vo2	19.8/-4	20.8/-4.2	VDC
	AMDG-121502A50JZ, 100% load, Vo1/Vo2	15/-2.5	15.75/-2.63	VDC
	AMDG-121504A50JZ, 100% load, Vo1/Vo2	15/-3.8	15.75/-4	VDC
	AMDG-121803A50JZ, 100% load, Vo1/Vo2	18/-3.15	18.9/-3.3	VDC
	AMDG-122005A50JZ, 100% load, Vo1/Vo2	19.5/-5.2	20.5/-5.45	VDC
	AMDG-151504A50JZ, 100% load, Vo1/Vo2	14.51/-4	15.26/-4.2	VDC
	AMDG-152005A50JZ, 100% load, Vo1/Vo2	19.5/-5.2	20.5/-5.45	VDC
	AMDG-241504A50JZ, 100% load, Vo1/Vo2	15.3/-4.16	16.05/-4.36	VDC
	AMDG-242005A50JZ, 100% load, Vo1/Vo2	20/-5	21/-5.25	VDC
Short circuit protection	Continues, Auto recovery			
Ripple & Noise	20MHz bandwidth, 10%-100% load, 5Vin	50	150	mV pk-pk
	20MHz bandwidth, 10%-100% load, Others	50	100	mV pk-pk

General Specifications				
Parameters	Conditions	Typical	Maximum	Units
Switching frequency*	100% Load	200		KHz
Operating temperature	With derating at 85°C	-40 to +105		°C
Storage temperature		-55 to +125		°C
Soldering temperature	1.5mm distance ≤ 10s		300	°C
Case temperature rise	100% Load	30	60	°C
Temperature coefficient	100% Load	± 0.04	± 0.1	%/°C
Cooling	Free air convection			
Humidity	Non-condensing		95	% RH
Case material	Heat resistant black Plastic (flammability to UL 94V-0)			
Weight		4.3		g
Dimensions (L x W x H)	0.77 x 0.39 x 0.49 inches (19.50 × 9.80 × 12.50 mm)			
MTBF	> 3 500 000 hrs (MIL-HDBK -217F, t=+25°C)			
NOTE: All specifications in this datasheet are measured at an ambient temperature of 25°C, humidity<75%, nominal input voltage and at rated output load unless otherwise specified.				

Safety Specifications		
Parameters		
Agency approvals	EN/UL 62368-1	
Standards	EMI - Conducted and radiated emission	CISPR32/EN55032 conducted Class B with EMI Application Circuit part A (5Vin models) CISPR32/EN55032 radiated Class A with EMI Application Circuit part A (5Vin models) CISPR32/EN55032 radiated Class B with EMI Application Circuit part B (5Vin models) CISPR32/EN55032 Class A with EMI Application Circuit part A (Other models)
	Electrostatic Discharge Immunity	IEC/EN 61000-4-2, Contact ±6KV, Criteria B (5Vin models) IEC/EN 61000-4-2, Contact ±8KV, Criteria B (Other modes)

Typical Characteristic



AMDG-051505A50JZ

Vo1

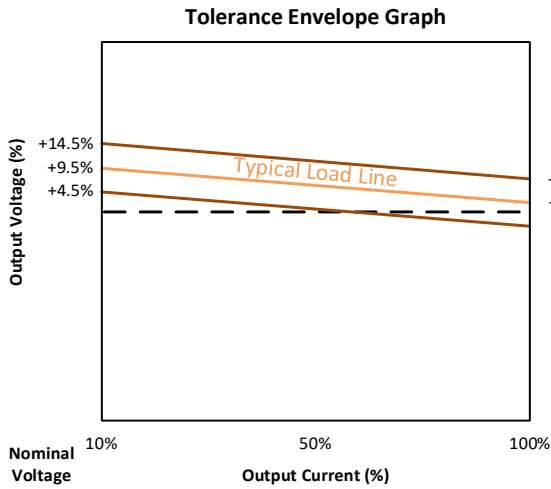

Vo2

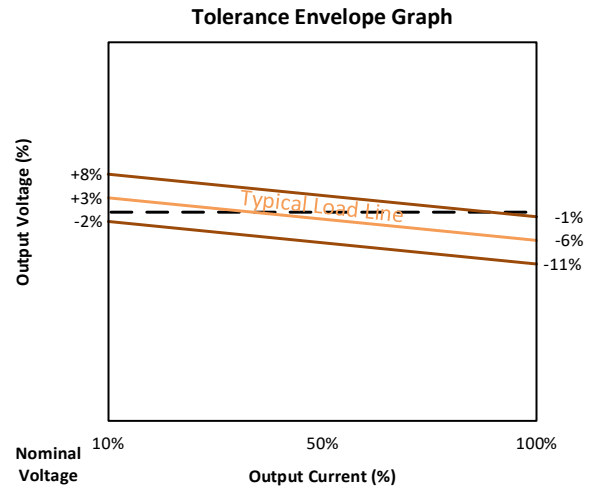

AMDG-051803A50JZ

Vo1

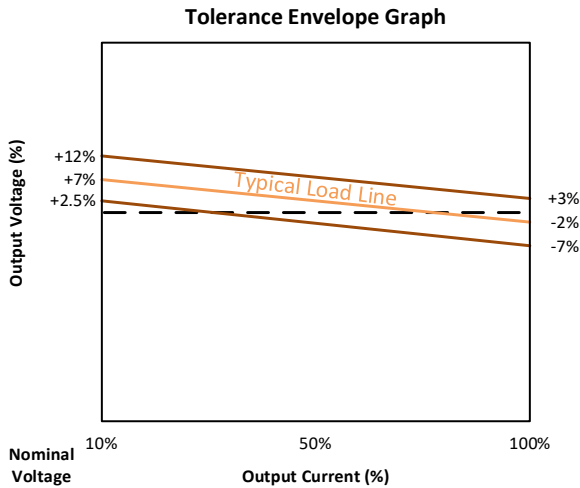

Vo2

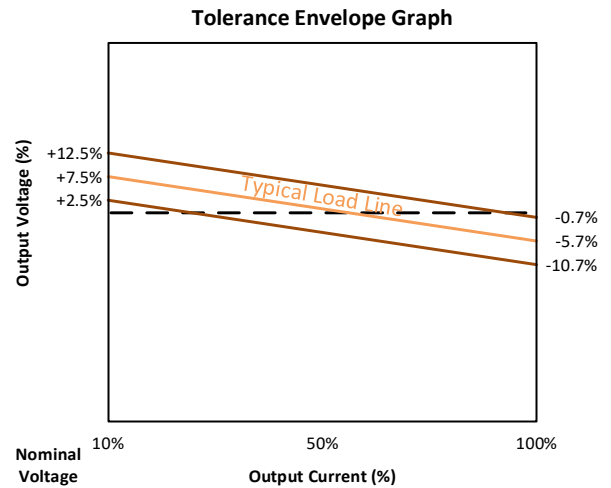

AMDG-052004A50JZ

Vo1

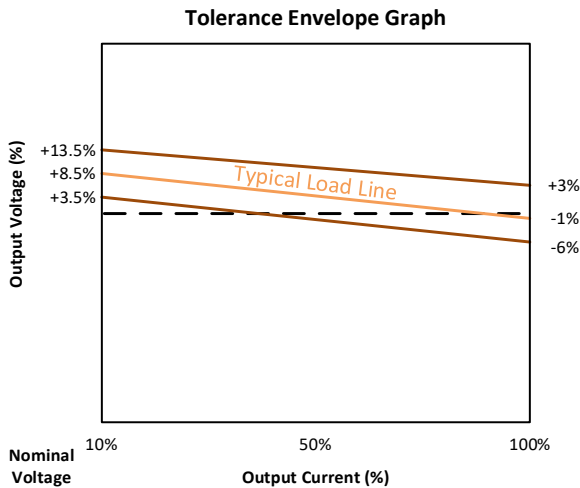

Vo2

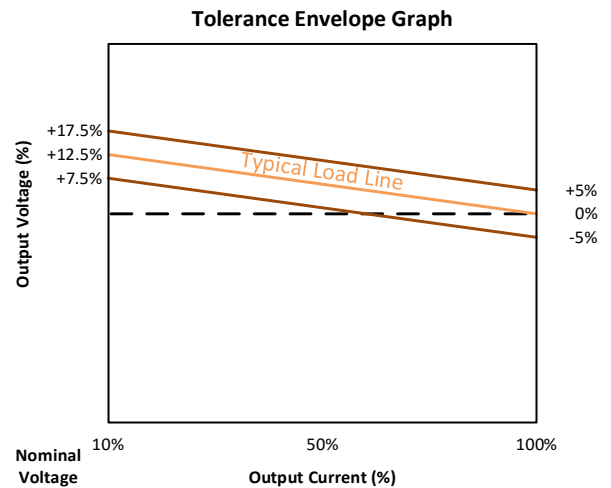

AMDG-121502A50JZ

Vo1

Tolerance Envelope Graph

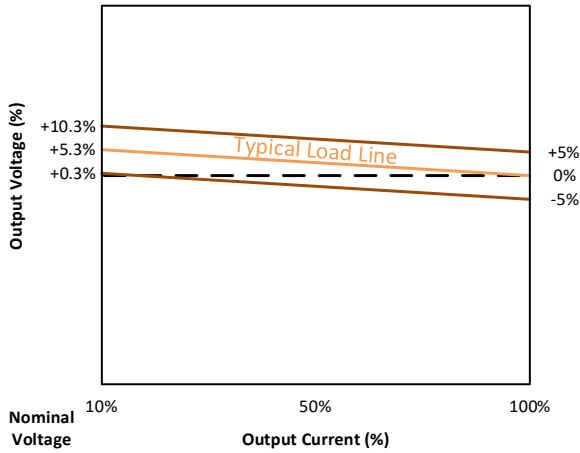

Vo2

Tolerance Envelope Graph

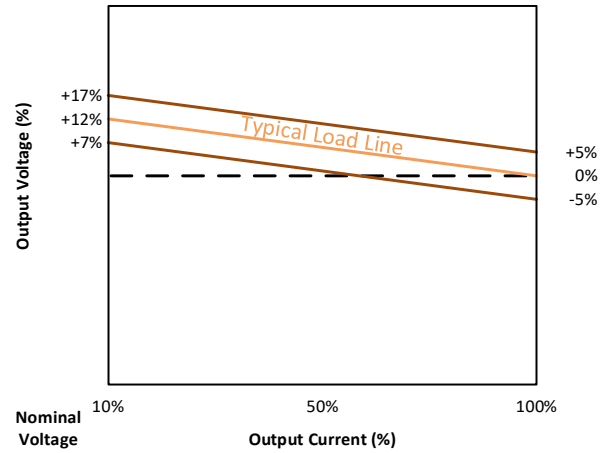

AMDG-121504A50JZ

Vo1

Tolerance Envelope Graph

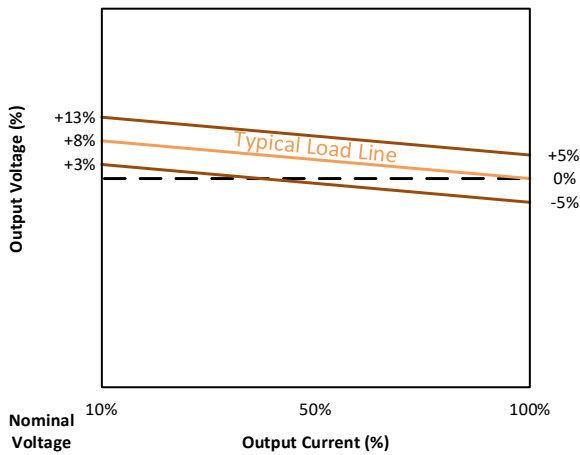

Vo2

Tolerance Envelope Graph

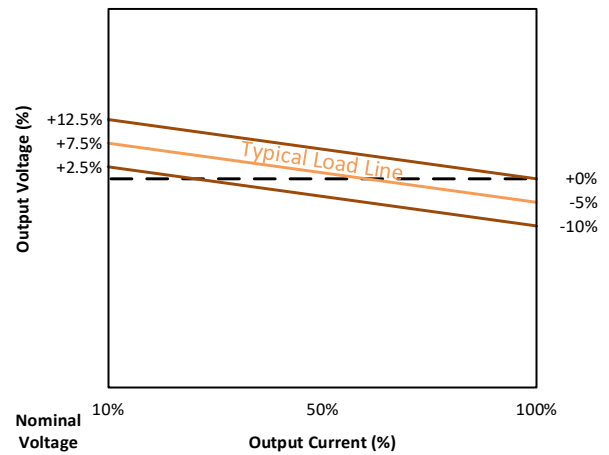

AMDG-121803A50JZ

Vo1

Tolerance Envelope Graph

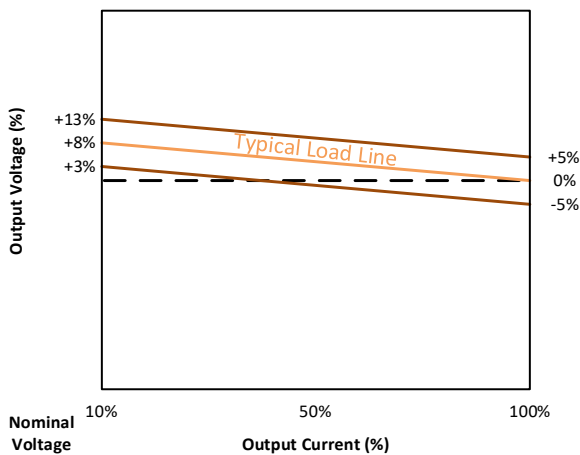

Vo2

Tolerance Envelope Graph

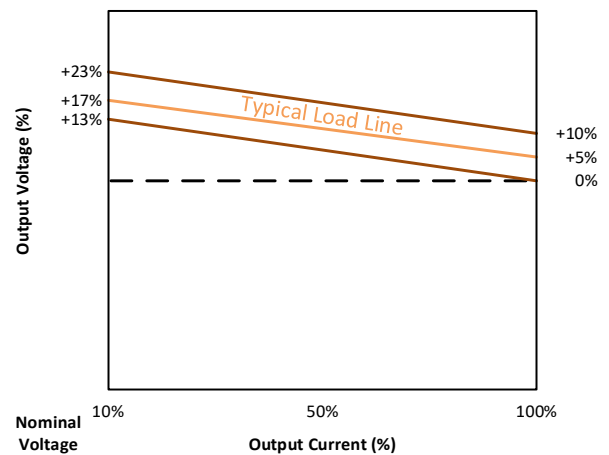

AMDG-122005A50JZ

Vo1

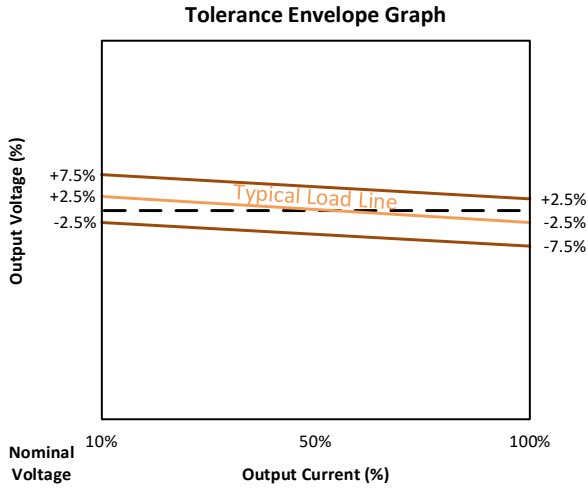

Vo2

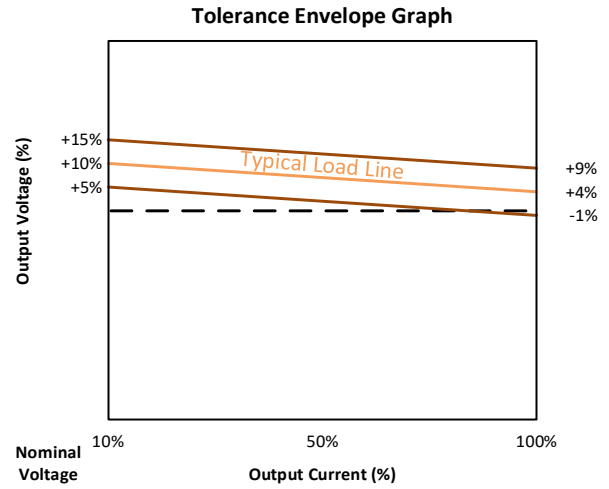

AMDG-151504A50JZ

Vo1

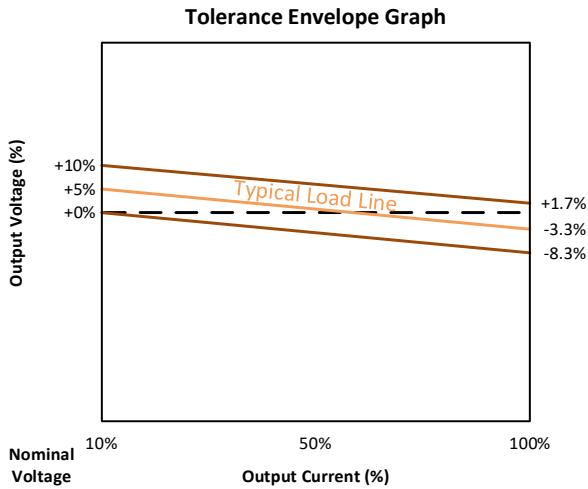

Vo2

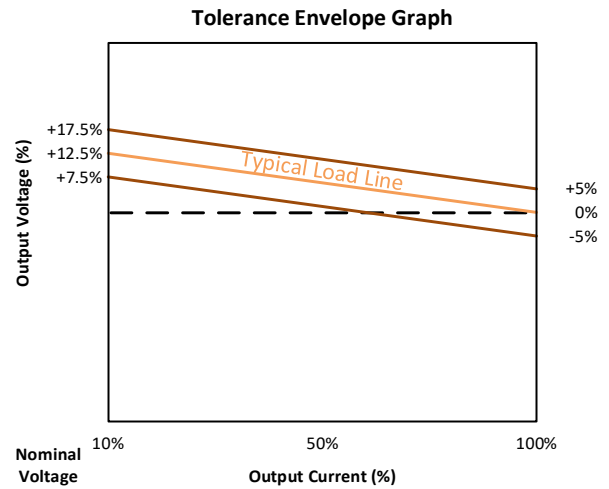

AMDG-152005A50JZ

Vo1

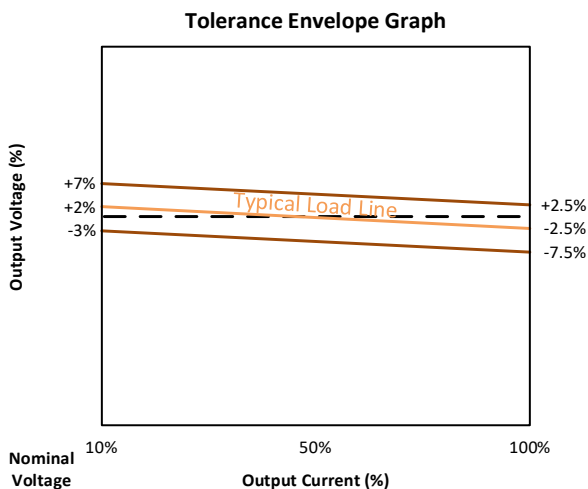

Vo2

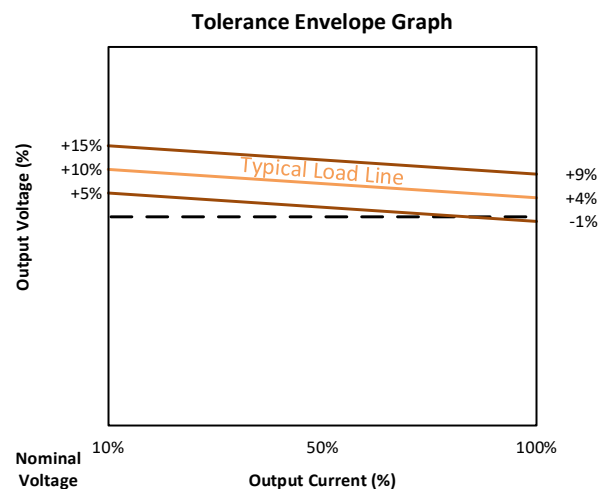

AMDG-241504A50JZ

Vo1



Vo2



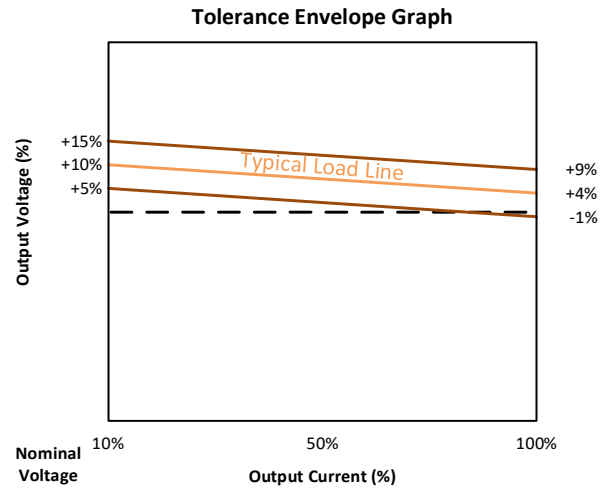
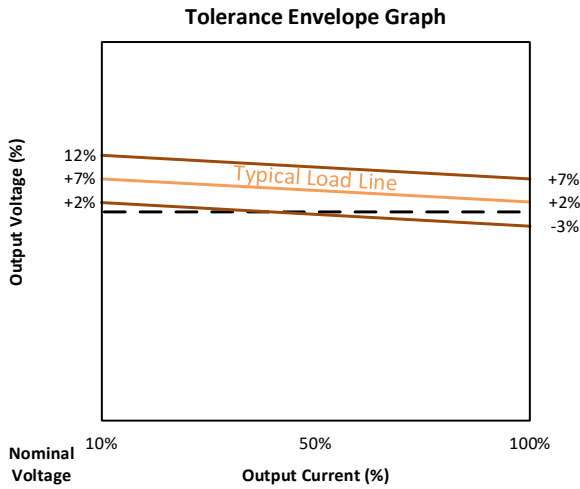

AMDG-242005A50JZ

Vo1

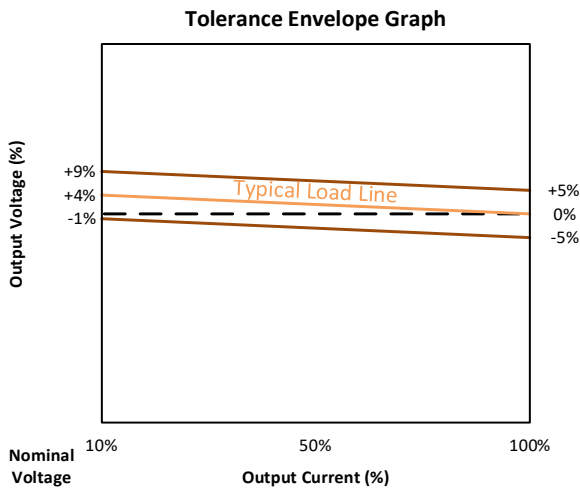

Vo2

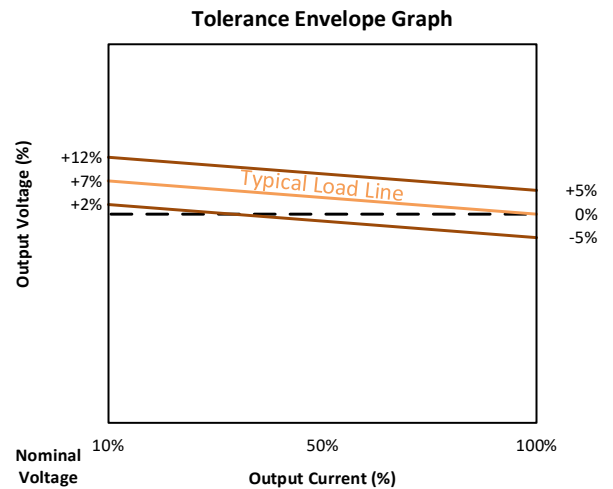

Derating



5Vin models

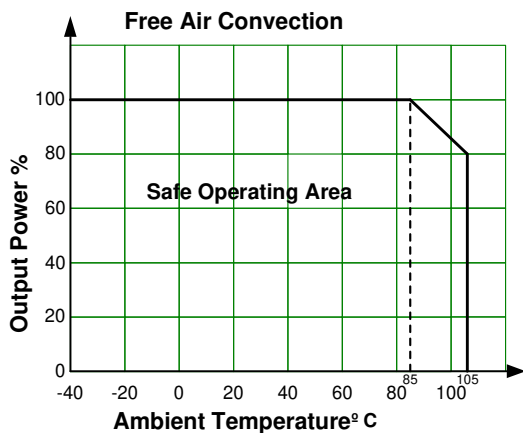

Other models

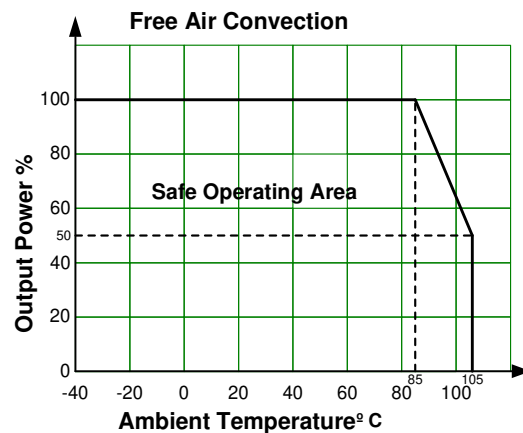

Typical Application Circuit

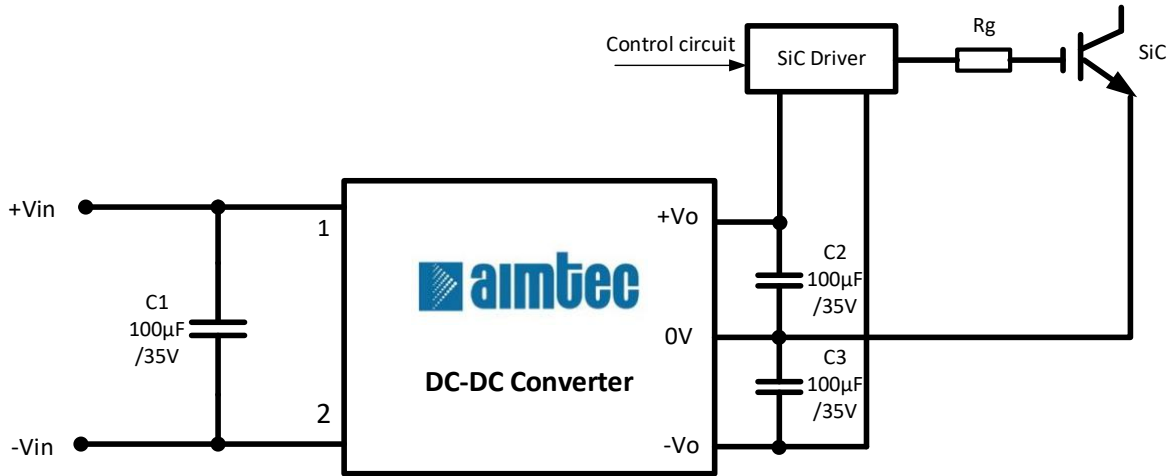

Note: Low internal resistance capacitors are recommended.

EMI Application Circuit

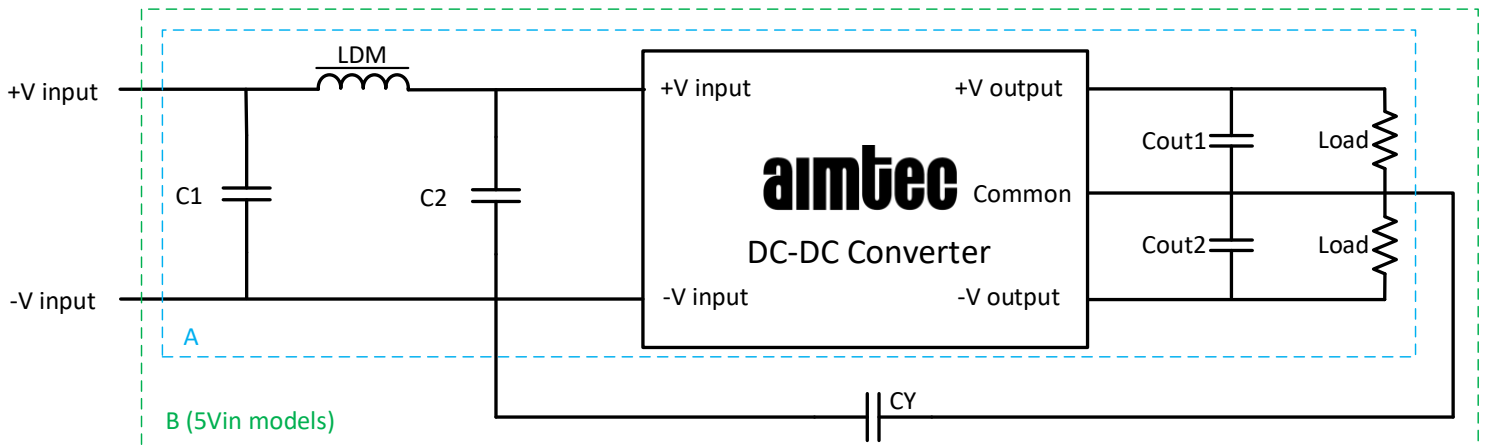

Component	5Vin models EMI		Other models EMI
	Part A	Part B	Part A
C1, C2	4.7µF/16V		1µF/50V
C3, C4 (Low Internal resistance)	10µF/50V		100µF/30V
LDM	6.8µH		33µH
CY	-	330pF	-

Note: Input and output capacitors are recommended to use ceramic or electrolytic types. Tantalum capacitors are not recommended.

Dimensions

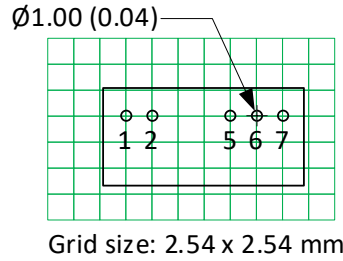
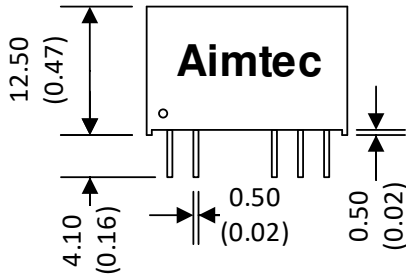

Pin Out Specifications	
Pin	Dual
1	+V Input
2	-V Input
5	-V Output 2
6	Com
7	+V Output 1

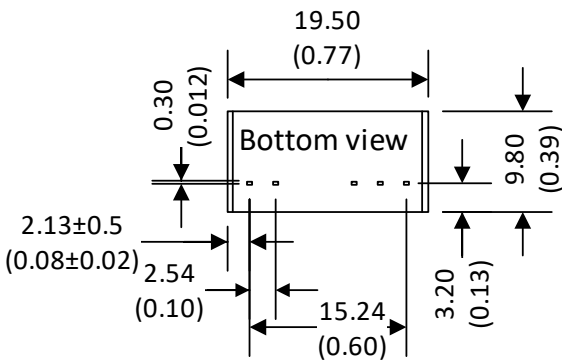

Note:
 Unit: mm (inch)
 General tolerance: $\pm 0.1 (\pm 0.004)$
 Pin tolerance: $\pm 0.5 (\pm 0.02)$

NOTE: 1. Datasheets are updated as needed and as such, specifications are subject to change without notice. Once printed or downloaded, datasheets are no longer controlled by Aimtec; refer to www.aimtec.com for the most current product specifications. 2. Product labels shown, including safety agency certifications on labels, may vary based on the date manufactured. 3. Mechanical drawings and specifications are for reference only. 4. All specifications are measured at an ambient temperature of 25°C, humidity < 75%, nominal input voltage and at rated output load unless otherwise specified. 5. Aimtec may not have conducted destructive testing or chemical analysis on all internal components and chemicals at the time of publishing this document. CAS numbers and other limited information are considered proprietary and may not be available for release. 6. This product is not designed for use in critical life support systems, equipment used in hazardous environments, nuclear control systems or other such applications which necessitate specific safety and regulatory standards other than the ones listed in this datasheet. 7. Warranty is in accordance with Aimtec's standard Terms of Sale available at www.aimtec.com.