

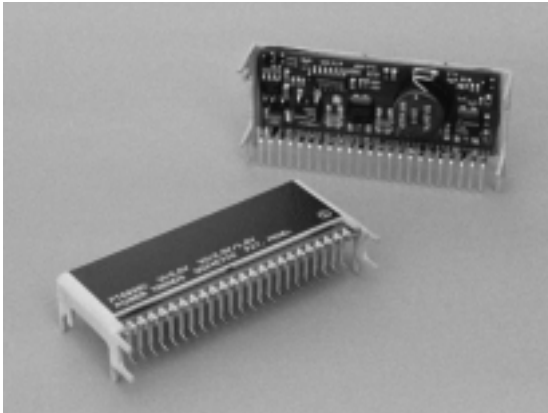

Features

- Dual Outputs
(See *Ordering Information*)
- 5V/3.3V Input
- Outputs Adjustable
- Remote Sensing (V_{O1} & V_{O2})
- Standby Function
- Soft-Start
- Internal Sequencing
- Short Circuit Protection
- 23-pin Space-Saving Package
- Solderable Copper Case
- Ideal Power Source for DSPs



Description

The PT6935 Excalibur™ series of power modules are dual output integrated switching regulators (ISRs) designed to power the latest mixed signal ICs. The dual output provides power for both the digital I/O logic and a DSP core from a single module. Both output voltages are internally sequenced during power-up and power-down to comply with the requirements of the latest DSP chips. Each output is independently adjustable or can be set to at least one alternative bus voltage with a simple pin-strap. The modules are made available in a space-saving solderable case. Features include an output current limit and short-circuit protection.

Ordering Information

- PT 6935□ = +2.5/1.8 Volts
- PT 6936□ = +3.3/2.5 Volts
- PT 6937□ = +3.3/1.8 Volts
- PT 6938□ = +3.3/1.2 Volts
- PT 6939□ = +2.5/1.2 Volts

PT Series Suffix (PT1234x)

Case/Pin Configuration	Order Suffix	Package Code
Vertical	N	(ELF)
Horizontal	A	(ELG)
SMD	C	(ELH)

(Reference the applicable package code drawing for the dimensions and PC layout)

Pin-Out Information

Pin	Function	Pin	Function
1	V_{O1} Sense	13	V_{O1}
2	No Connect	14	V_{O1}
3	STBY	15	V_{O1}
4	V_{in}	16	V_{O1} Adjust*
5	V_{in}	17	No Connect
6	V_{in}	18	V_{O2}
7	GND	19	V_{O2}
8	GND	20	V_{O2}
9	GND	21	V_{O2}
10	GND	22	V_{O2} Sense
11	GND	23	V_{O2} Adjust*
12	V_{O1}		

* V_{O1} and V_{O2} can be pin-strapped to another voltage. See application note on output voltage adjustment.

Standard Application

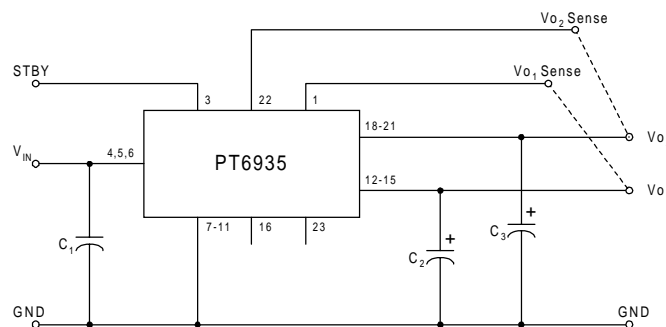

- C_1 = Req'd 330 μ F * electrolytic
- C_2 = Req'd 330 μ F * electrolytic
- C_3 = Optional 100 μ F electrolytic

* 300 μ F for Oscon® or low ESR tantalum -see notes

General Specifications (Unless otherwise stated, $T_a = 25^\circ\text{C}$, $V_{in} = 5\text{V}$)

Characteristic	Symbol	Conditions	PT6935 Series			Units
			Min	Typ	Max	
Short Circuit Current	I_{sc}	$Io_1 + Io_2$ combined	—	17	—	A
Switching Frequency	f_o	Over V_{in} range	300	350	400	kHz
Standby (Pin 3)		Referenced to GND (pin 7)				
Input High Voltage	V_{IH}		—	—	Open ⁽¹⁾	V
Input Low Voltage	V_{IL}		-0.1	—	+0.4	
Input Low Current	I_{IL}		—	-0.5	—	mA
Standby Input Current	$I_{in, standby}$	pin 3 to GND	—	7	25	mA
External Output Capacitance	C_2 C_3		330 ⁽²⁾ 0	—	3,300 ⁽²⁾ 330	μF
Maximum Operating Temperature Range	T_a	Over V_{in} Range	-40 ⁽³⁾	—	+85 ⁽⁴⁾	$^\circ\text{C}$
Storage Temperature	T_s	—	-40	—	+125	$^\circ\text{C}$
Mechanical Shock		Per Mil-STD-883D, Method 2002.3 1 msec, ½ Sine, mounted	—	500	—	G's
Mechanical Vibration		Per Mil-STD-883D, Method 2007.2 20-2000 Hz, Soldered in a PC board	—	15 ⁽⁵⁾	—	G's
Weight	—	Vertical/Horizontal	—	26	—	grams
Flammability	—	Meets UL 94V-O	—	—	—	—

- Notes:**
- (1) The Standby (pin 3) has an internal pull-up, and if it is left open circuit the module will operate when input power is applied. The open-circuit voltage is less than 15V. Refer to the application notes for interface considerations.
 - (2) A value of 300 μF is sufficient if Oscon® or low ESR tantalum type capacitors are used. The total combined ESR of all output capacitance at 100kHz must be (greater than) $>12\text{ m}\Omega$, and (less or equal to) $\leq 150\text{ m}\Omega$.
 - (3) For operating temperatures below 0°C , C_{in} and C_{out} must have stable characteristics. Use either tantalum or Oscon® capacitors.
 - (4) See Safe Operating Area curves for the specific output voltage combination, or contact the factory for the appropriate derating.
 - (5) Only the case pins on through-hole pin configurations (N & A) must be soldered. For more information see the applicable package outline drawing.

Input/Output Capacitors: The PT6935 series requires a 330 μF electrolytic capacitor at both the input and output for proper operation (300 μF for Oscon® or low ESR tantalum). In addition, the input capacitance must be rated for a minimum of 1.0Arms ripple current. For transient or dynamic load applications, additional capacitance may be required. Refer to the application notes for more information.

Power-up Sequencing and Vo_1/Vo_2 Loading

Power-up Sequencing

The PT6935 series of regulators provide two output voltages, Vo_1 and Vo_2 . Each of the output voltage combinations offered by the PT6935 series provides power for both a low-voltage processor core, and the associated digital support circuitry. In addition, each output is internally sequenced during power-up and power-down to comply with the requirements of most DSP and μP IC's, and their accompanying chipsets. Figure 1 shows the typical waveforms of the output voltages, Vo_1 and Vo_2 , from the instance that either input power is applied or the module is enabled via the Standby pin. Following a delay of about 10 to 15 milli-secs, the voltages at Vo_1 and Vo_2 rise together until Vo_2 reaches its set-point. Then Vo_1 continues to rise until both output voltages have reached full voltage.

Figure 1; PT6935 Series Power-up

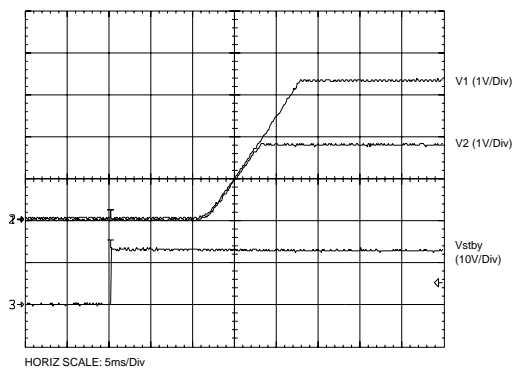

Vo_1/Vo_2 Loading

The output voltages from the PT6935 series regulators are independently regulated. The voltage at Vo_1 is produced by a highly efficient switching regulator. The lower output voltage, Vo_2 , is derived from Vo_1 . The regulation method used for Vo_2 also provides control of this output voltage during power-down. Vo_2 will sink current if the voltage at Vo_1 attempts to fall below it.

The load specifications for each model of the PT6935 series gives both a 'Typical' (Typ) and 'Maximum' (Max) load current for each output. For operation within the product's rating, the load currents at Vo_1 and Vo_2 must comply with the following limits:-

- Io_2 must be less than $Io_2(\text{max})$.
- The sum-total current from both outputs ($Io_1 + Io_2$) must not exceed $Io_1(\text{max})$.

In the case that either Vo_1 or Vo_2 are adjusted to some other value than the default output voltage, the absolute maximum load current for Io_2 must be revised to comply with the following equation.

$$Io_2(\text{max}) = \frac{2.5}{Vo_1 - Vo_2} \text{ Adc}$$

Consult the specification table for each model of the series for the actual numeric values.

PT6935 Performance Specifications (Unless otherwise stated, $T_a = 25^\circ\text{C}$, $V_{in} = 5\text{V}$, $C_1 = 330\mu\text{F}$, $C_2 = 330\mu\text{F}$, $I_{O1} = I_{O1\text{typ}}$, and $I_{O2} = I_{O2\text{typ}}$)

Characteristic	Symbol	Conditions	PT6935 (2.5V/1.8V)			Units	
			Min	Typ	Max		
Output Current	I_{O1}	$T_a = 25^\circ\text{C}$, natural convection	V_{O1} (2.5V)	0.1 (i)	7 (ii)	9.5 (iii)	A
	I_{O2}		V_{O2} (1.8V)	0	2.5 (ii)	3.5 (iii)	
	I_{O1}	$T_a = 60^\circ\text{C}$, 200LFM airflow	V_{O1} (2.5V)	0.1 (i)	7 (ii)	10 (iii)	A
	I_{O2}		V_{O2} (1.8V)	0	2.5 (ii)	3.5 (iii)	
Input Voltage Range	V_{in}	Over I_o Range		3.1	—	5.5	VDC
Set Point Voltage Tolerance	$V_o \text{ tol}$		V_{O1}	—	± 12	± 38	mV
			V_{O2}	—	± 9	± 27	
Temperature Variation	Reg_{temp}	$-40^\circ > T_a > +85^\circ\text{C}$		—	± 0.5	—	$\%V_o$
Line Regulation	Reg_{line}	Over V_{in} range	V_{O1}	—	± 5	± 10	mV
			V_{O2}	—	± 2	± 5	
Load Regulation	Reg_{load}	Over I_o range	V_{O1}	—	± 5	± 10	mV
			V_{O2}	—	± 5	± 10	
Total Output Voltage Variation	$\Delta V_{o\text{tot}}$	Includes set-point, line, load, $-40^\circ > T_a > +85^\circ\text{C}$	V_{O1}	—	± 34	—	mV
			V_{O2}	—	± 25	—	
Efficiency	η			—	79	—	%
V_o Ripple (pk-pk)	V_r	20MHz bandwidth	V_{O1}	—	3.5	—	mV _{pp}
			V_{O2}	—	3.5	—	
Transient Response	t_{tr}	1A/μs load step, 50% to 100% $I_{o\text{typ}}$		—	60	—	μs
	ΔV_{tr}	V_o over/undershoot	V_{O1}	—	± 60	—	mV
			V_{O2}	—	± 60	—	

Notes: (i) I_{O1} (min) current of 0.1A can be divided between both outputs, V_{O1} or V_{O2} . The module will operate at no load with reduced specifications.
 (ii) The typical current is that which can be drawn simultaneously from both outputs under the stated operating conditions.
 (iii) The sum of I_{O1} and I_{O2} must be less than $I_{O1\text{max}}$, and I_{O2} must be less than $I_{O2\text{max}}$.

PT6935 Typical Characteristics

Efficiency vs I_{O1} (See Note A)

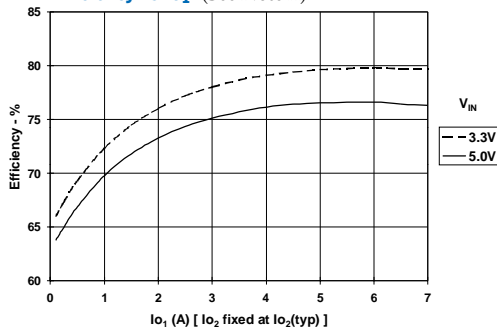

Power Dissipation vs I_{O1} (See Note A)

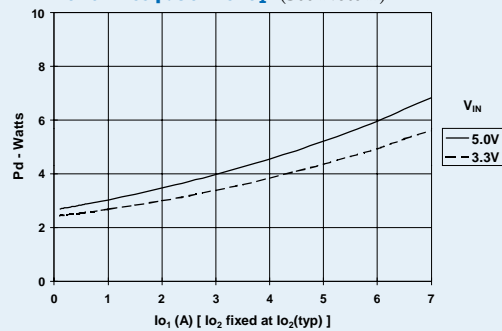

V_{O1} Output Ripple vs I_{O1} (See Note A)

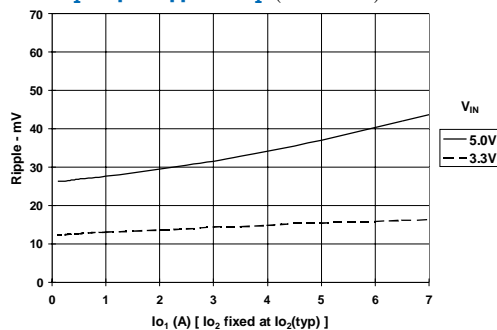

Safe Operating Area, $V_{in} = 5\text{V}$ (See Note B)

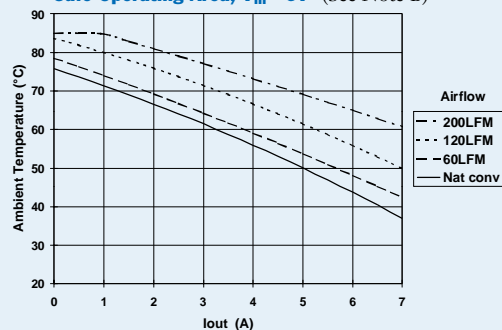

Note A: Characteristic data has been developed from actual products tested at 25°C . This data is considered typical data for the Converter.

Note B: SOA curves represent the conditions at which internal components are at or below the manufacturer's maximum operating temperatures

PT6936 Performance Specifications (Unless otherwise stated, $T_a = 25^\circ\text{C}$, $V_{in} = 5\text{V}$, $C_1 = 330\mu\text{F}$, $C_2 = 330\mu\text{F}$, $I_{O1} = I_{O1\text{typ}}$, and $I_{O2} = I_{O2\text{typ}}$)

Characteristic	Symbol	Conditions	PT6936 (3.3V/2.5V)			Units	
			Min	Typ	Max		
Output Current	I_{O1}	$T_a = 25^\circ\text{C}$, natural convection	V_{O1} (3.3V)	0.1 (i)	8 (ii)	11 (iii)	A
	I_{O2}		V_{O2} (2.5V)	0	3 (ii)	3 (iii)	
	I_{O1}	$T_a = 60^\circ\text{C}$, 200LFM airflow	V_{O1} (3.3V)	0.1 (i)	8 (ii)	11 (iii)	A
	I_{O2}		V_{O2} (2.5V)	0	3 (ii)	3 (iii)	
Input Voltage Range	V_{in}	Over I_o Range	4.5	—	5.5	VDC	
Set Point Voltage Tolerance	$V_o \text{ tol}$		V_{O1}	—	± 16	± 50	mV
			V_{O2}	—	± 12	± 38	
Temperature Variation	Reg_{temp}	$-40^\circ > T_a > +85^\circ\text{C}$	—	± 0.5	—	$\%V_o$	
Line Regulation	Reg_{line}	Over V_{in} range	V_{O1}	—	± 5	± 10	mV
			V_{O2}	—	± 2	± 5	
Load Regulation	Reg_{load}	Over I_o range	V_{O1}	—	± 5	± 10	mV
			V_{O2}	—	± 5	± 10	
Total Output Voltage Variation	$\Delta V_{o\text{tot}}$	Includes set-point, line, load, $-40^\circ > T_a > +85^\circ\text{C}$	V_{O1}	—	± 29	—	mV
			V_{O2}	—	± 34	—	
Efficiency	η			—	81	—	%
V_o Ripple (pk-pk)	V_r	20MHz bandwidth	V_{O1}	—	3.5	—	mV _{pp}
			V_{O2}	—	3.5	—	
Transient Response	t_{tr}	1A/1 μs load step, 50% to 100% I_o ,typ		—	60	—	μs
	ΔV_{tr}	V_o over/undershoot	V_{O1}	—	± 60	—	mV
			V_{O2}	—	± 60	—	

Notes: (i) I_{O1} (min) current of 0.1A can be divided between both outputs, V_{O1} or V_{O2} . The module will operate at no load with reduced specifications.
(ii) The typical current is that which can be drawn simultaneously from both outputs under the stated operating conditions.
(iii) The sum of I_{O1} and I_{O2} must be less than $I_{O1\text{max}}$, and I_{O2} must be less than $I_{O2\text{max}}$.

PT6936 Typical Characteristics

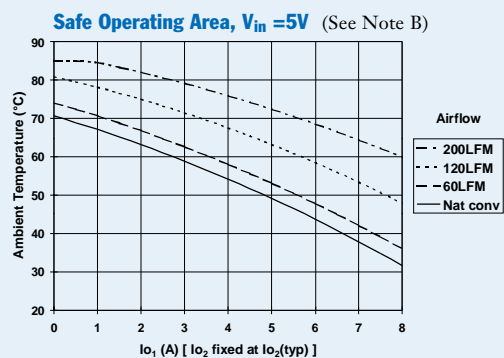
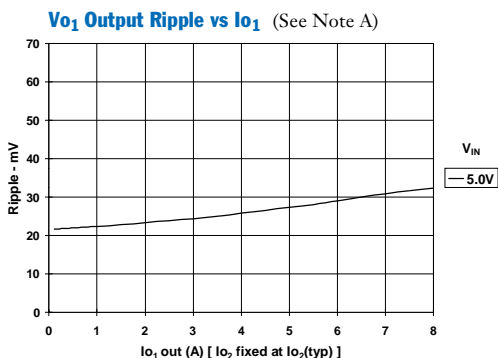
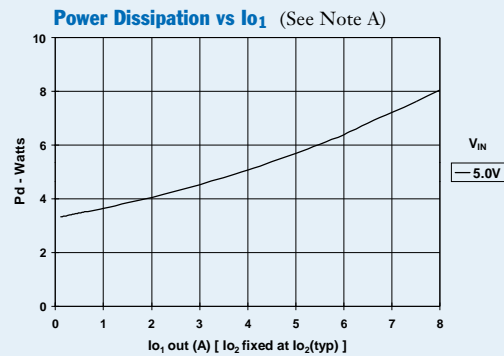
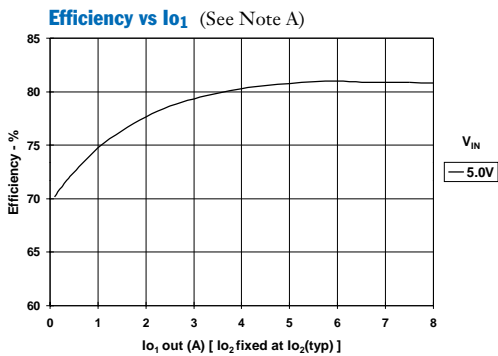

Note A: Characteristic data has been developed from actual products tested at 25°C . This data is considered typical data for the Converter.

Note B: SOA curves represent the conditions at which internal components are at or below the manufacturer's maximum operating temperatures

PT6937 Performance Specifications (Unless otherwise stated, $T_a = 25^\circ\text{C}$, $V_{in} = 5\text{V}$, $C_1 = 330\mu\text{F}$, $C_2 = 330\mu\text{F}$, $I_{O1} = I_{O1\text{typ}}$, and $I_{O2} = I_{O2\text{typ}}$)

Characteristic	Symbol	Conditions	PT6937 (3.3V/1.8V)			Units	
			Min	Typ	Max		
Output Current	I_{O1}	$T_a = 25^\circ\text{C}$, natural convection	V_{O1} (3.3V)	0.1 (i)	8 (ii)	10 (iii)	A
	I_{O2}		V_{O2} (1.8V)	0	2 (ii)	2.25 (iii)	
Input Voltage Range	V_{in}	Over I_o Range		4.5	—	5.5	VDC
			Set Point Voltage Tolerance	V_{O1}	—	± 16	
Temperature Variation	Reg_{temp}	$-40^\circ > T_a > +85^\circ\text{C}$	V_{O2}	—	± 9	± 27	
Line Regulation	Reg_{line}	Over V_{in} range	V_{O1}	—	± 0.5	—	$\%V_o$
Load Regulation	Reg_{load}	Over I_o range	V_{O1}	—	± 5	± 10	mV
			V_{O2}	—	± 5	± 10	
Total Output Voltage Variation	$\Delta V_{o\text{tot}}$	Includes set-point, line, load, $-40^\circ > T_a > +85^\circ\text{C}$	V_{O1}	—	± 29	—	mV
Efficiency	η		V_{O2}	—	± 25	—	
V_o Ripple (pk-pk)	V_r	20MHz bandwidth	V_{O1}	—	3.5	—	mV _{pp}
			V_{O2}	—	3.5	—	
Transient Response	t_{tr}	1A/ μs load step, 50% to 100% I_o ,typ	V_{O1}	—	60	—	μs
	ΔV_{tr}	V_o over/undershoot	V_{O1}	—	± 60	—	mV
			V_{O2}	—	± 60	—	

Notes: (i) I_{O1} (min) current of 0.1A can be divided between both outputs, V_{O1} or V_{O2} . The module will operate at no load with reduced specifications.
 (ii) The typical current is that which can be drawn simultaneously from both outputs under the stated operating conditions.
 (iii) The sum of I_{O1} and I_{O2} must be less than $I_{O1\text{max}}$, and I_{O2} must be less than $I_{O2\text{max}}$.

PT6937 Typical Characteristics

Efficiency vs I_{O1} (See Note A)



Power Dissipation vs I_{O1} (See Note A)

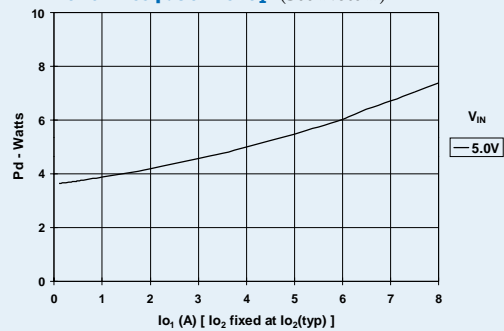

V_{O1} Output Ripple vs I_{O1} (See Note A)

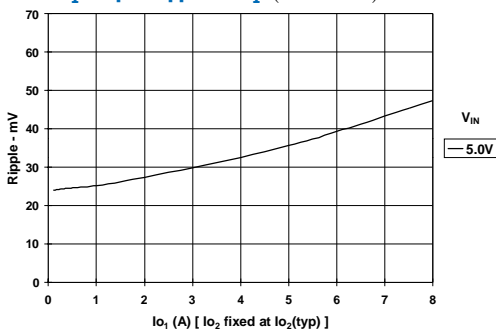

Safe Operating Area, $V_{in} = 5\text{V}$ (See Note B)

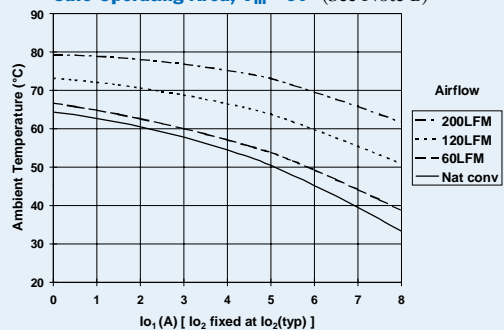

Note A: Characteristic data has been developed from actual products tested at 25°C . This data is considered typical data for the Converter.

Note B: SOA curves represent the conditions at which internal components are at or below the manufacturer's maximum operating temperatures

PT6938 Performance Specifications (Unless otherwise stated, $T_a = 25^\circ\text{C}$, $V_{in} = 5\text{V}$, $C_1 = 330\mu\text{F}$, $C_2 = 330\mu\text{F}$, $I_{O1} = I_{O1typ}$, and $I_{O2} = I_{O2typ}$)

Characteristic	Symbol	Conditions	PT6938 (3.3V/1.2V)			Units	
			Min	Typ	Max		
Output Current	I_{O1}	$T_a = 25^\circ\text{C}$, natural convection	V_{O1} (3.3V)	0.1 (i)	7 (ii)	8.6 (iii)	A
	I_{O2}		V_{O2} (1.2V)	0	1.6 (ii)	1.6 (iii)	
	I_{O1}	$T_a = 60^\circ\text{C}$, 200LFM airflow	V_{O1} (3.3V)	0.1 (i)	7 (ii)	8.6 (iii)	A
	I_{O2}		V_{O2} (1.2V)	0	1.6 (ii)	1.6 (iii)	
Input Voltage Range	V_{in}	Over I_o Range		4.5	—	5.5	VDC
Set Point Voltage Tolerance	$V_o \text{ tol}$		V_{O1}	—	± 16	± 50	mV
			V_{O2}	—	± 6	± 18	
Temperature Variation	Reg_{temp}	$-40^\circ > T_a > +85^\circ\text{C}$		—	± 0.5	—	$\%V_o$
Line Regulation	Reg_{line}	Over V_{in} range	V_{O1}	—	± 5	± 10	mV
			V_{O2}	—	± 2	± 5	
Load Regulation	Reg_{load}	Over I_o range	V_{O1}	—	± 5	± 10	mV
			V_{O2}	—	± 5	± 10	
Total Output Voltage Variation	ΔV_{otot}	Includes set-point, line, load, $-40^\circ > T_a > +85^\circ\text{C}$	V_{O1}	—	± 29	—	mV
			V_{O2}	—	± 19	—	
Efficiency	η			—	79	—	%
V_o Ripple (pk-pk)	V_r	20MHz bandwidth	V_{O1}	—	3.5	—	mV _{pp}
			V_{O2}	—	3.5	—	
Transient Response	t_{tr}	1A/μs load step, 50% to 100% I_o ,typ		—	60	—	μs
	ΔV_{tr}	V_o over/undershoot	V_{O1}	—	± 60	—	
			V_{O2}	—	± 60	—	mV

Notes: (i) I_{O1} (min) current of 0.1A can be divided between both outputs, V_{O1} or V_{O2} . The module will operate at no load with reduced specifications.
 (ii) The typical current is that which can be drawn simultaneously from both outputs under the stated operating conditions.
 (iii) The sum of I_{O1} and I_{O2} must be less than I_{O1max} , and I_{O2} must be less than I_{O2max} .

PT6938 Typical Characteristics

Efficiency vs I_{O1} (See Note A)

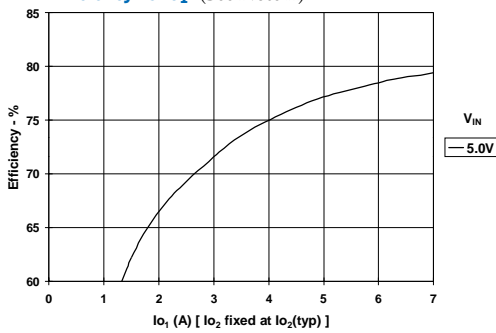

Power Dissipation vs I_{O1} (See Note A)

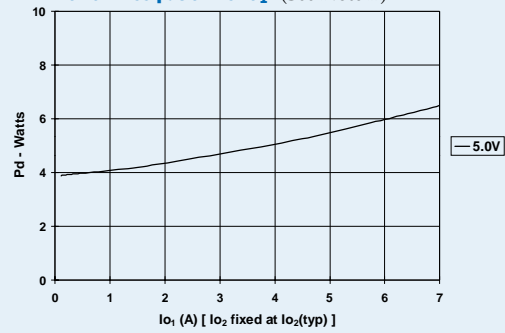

V_{O1} Output Ripple vs I_{O1} (See Note A)

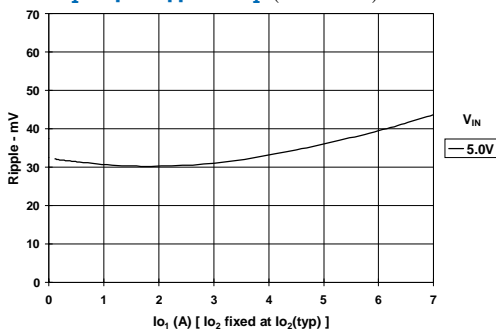

Safe Operating Area, $V_{in} = 5\text{V}$ (See Note B)

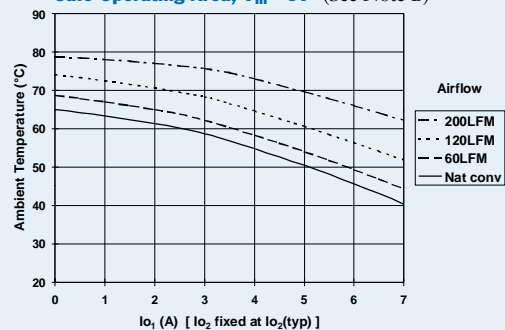

Note A: Characteristic data has been developed from actual products tested at 25°C . This data is considered typical data for the Converter.

Note B: SOA curves represent the conditions at which internal components are at or below the manufacturer's maximum operating temperatures

PT6939 Performance Specifications (Unless otherwise stated, $T_a = 25^\circ\text{C}$, $V_{in} = 5\text{V}$, $C_1 = 330\mu\text{F}$, $C_2 = 330\mu\text{F}$, $I_{O1} = I_{O1typ}$, and $I_{O2} = I_{O2typ}$)

Characteristic	Symbol	Conditions	PT6939 (2.5V/1.2V)			Units	
			Min	Typ	Max		
Output Current	I_{O1}	$T_a = 25^\circ\text{C}$, natural convection	V_{O1} (2.5V)	0.1 (i)	7 (ii)	9 (iii)	A
	I_{O2}		V_{O2} (1.2V)	0	2 (ii)	2.2 (iii)	
	I_{O1}	$T_a = 60^\circ\text{C}$, 200LFM airflow	V_{O1} (2.5V)	0.1 (i)	7 (ii)	9 (iii)	A
	I_{O2}		V_{O2} (1.2V)	0	2 (ii)	2.2 (iii)	
Input Voltage Range	V_{in}	Over I_o Range		3.1	—	5.5	VDC
Set Point Voltage Tolerance	$V_o \text{ tol}$		V_{O1}	—	± 12	± 38	mV
			V_{O2}	—	± 6	± 18	
Temperature Variation	Reg_{temp}	$-40^\circ > T_a > +85^\circ\text{C}$		—	± 0.5	—	$\%V_o$
Line Regulation	Reg_{line}	Over V_{in} range	V_{O1}	—	± 5	± 10	mV
			V_{O2}	—	± 2	± 5	
Load Regulation	Reg_{load}	Over I_o range	V_{O1}	—	± 5	± 10	mV
			V_{O2}	—	± 5	± 10	
Total Output Voltage Variation	ΔV_{otot}	Includes set-point, line, load, $-40^\circ > T_a > +85^\circ\text{C}$	V_{O1}	—	± 34	—	mV
			V_{O2}	—	± 19	—	
Efficiency	η			—	75	—	%
V_o Ripple (pk-pk)	V_r	20MHz bandwidth	V_{O1}	—	3.5	—	mV _{pp}
			V_{O2}	—	3.5	—	
Transient Response	t_{tr}	1A/μs load step, 50% to 100% I_o typ		—	60	—	μs
	ΔV_{tr}	V_o over/undershoot	V_{O1}	—	± 60	—	mV
			V_{O2}	—	± 60	—	

Notes: (i) I_{O1} (min) current of 0.1A can be divided between both outputs, V_{O1} or V_{O2} . The module will operate at no load with reduced specifications.
 (ii) The typical current is that which can be drawn simultaneously from both outputs under the stated operating conditions.
 (iii) The sum of I_{O1} and I_{O2} must be less than I_{O1max} , and I_{O2} must be less than I_{O2max} .

PT6939 Typical Characteristics

Efficiency vs I_{O1} (See Note A)

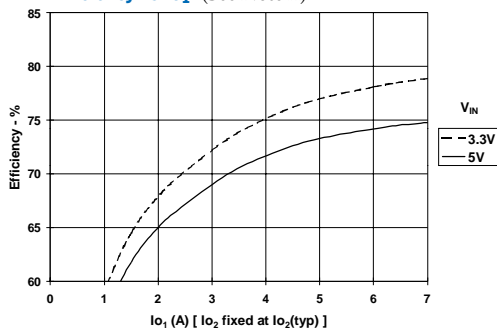

Power Dissipation vs I_{O1} (See Note A)

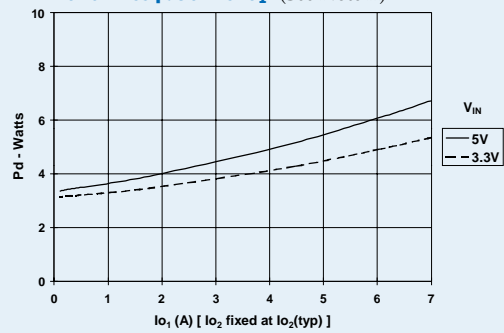

V_{O1} Output Ripple vs I_{O1} (See Note A)

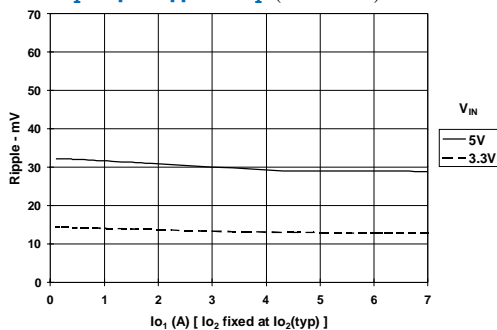

Safe Operating Area, $V_{in} = 5\text{V}$ (See Note B)

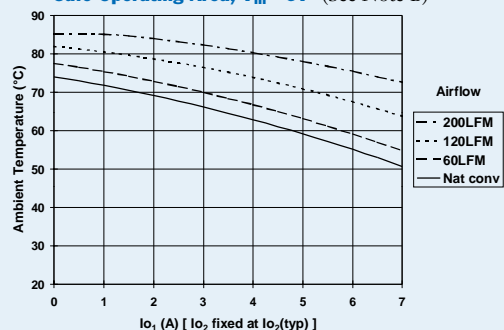

Note A: Characteristic data has been developed from actual products tested at 25°C . This data is considered typical data for the Converter.

Note B: SOA curves represent the conditions at which internal components are at or below the manufacturer's maximum operating temperatures

Capacitor Recommendations for the Dual-Output PT6935 Regulator Series

Input Capacitors:

The recommended input capacitance is determined by 1.0 ampere minimum ripple current rating and 330µF minimum capacitance (300µF for Oscon® or low ESR tantalum). Ripple current and <100mΩ equivalent series resistance (ESR) values are the major considerations, along with temperature, when designing with different types of capacitors. Tantalum capacitors have a recommended minimum voltage rating of 2 × the maximum DC voltage + AC ripple. This is necessary to insure reliability for input voltage bus applications

Output Capacitors: C₂(Required), C₃(Optional)

The ESR of the required capacitor (C₂) must not be greater than 150mΩ. Electrolytic capacitors have poor ripple performance at frequencies greater than 400kHz but excellent low frequency transient response. Above the ripple frequency, ceramic capacitors are necessary to improve the transient response and reduce any high frequency noise components apparent during higher current excursions. Preferred low ESR type capacitor part numbers are identified in Table 1. The optional 100µF capacitor (C₃) for V_{2out} can have an ESR of up to 200mΩ for optimum performance and ripple reduction. (Note: Vendor part numbers for the optional capacitor, C₃, are not identified in the table. Use the same series selected for C₂)

Tantalum Capacitors

Tantalum type capacitors can be used for the output but only the AVX TPS series, Sprague 593D/594/595 series or Kemet T495/T510 series. These capacitors are recommended over many other tantalum types due to their higher rated surge, power dissipation, and ripple current capability. As a caution the TAJ series by AVX is not recommended. This series has considerably higher ESR, reduced power dissipation, and lower ripple current capability. The TAJ series is less reliable than the AVX TPS series when determining power dissipation capability. Tantalum or Oscon® types are recommended for applications where ambient temperatures fall below 0°C.

Capacitor Table

Table 1 identifies the characteristics of capacitors from a number of vendors with acceptable ESR and ripple current (rms) ratings. The number of capacitors required at both the input and output buses is identified for each capacitor type.

This is not an extensive capacitor list. Capacitors from other vendors are available with comparable specifications. Those listed are for guidance. The RMS ripple current rating and ESR (Equivalent Series Resistance at 100kHz) are critical parameters necessary to insure both optimum regulator performance and long capacitor life.

Table 1: Input/Output Capacitors

Capacitor Vendor/ Component Series	Capacitor Characteristics					Quantity		Vendor Number
	Working Voltage	Value(µF)	(ESR) Equivalent Series Resistance	85°C Maximum Ripple Current(Irms)	Physical Size(mm)	Input Bus	Output Bus	
Panasonic FC	25V	560µF	0.0065Ω	1205mA	12.5x15	1	1	EEUFC1E561S
	35V	390µF	0.065Ω	1205mA	12.5x15	2	1	EEUFC1V391S
	35V	330µF	0.117Ω	555mA	8x11.5	N/R	1	EEUFC1C331
United Chemi-Con LXV/FS/LXZ	16V	330µF	0.120Ω	555mA	8x12	N/R	1	LXZ16VB331M8X12LL
	35V	470µF	0.052Ω	1220mA	10x20	1	1	LXZ35VB471M10X20LL
	10V	330µF	0.025Ω	3500mA	10x10.5	1	1	10FS330M
	20V	150µF	0.030+2 Ω	3200mA	10x10.5	2	2	20FS150M
Nichicon PL/ PM	35V	560µF	0.048Ω	1360mA	16x15	1	1	UPL1V561MHH6
	35V	330µF	0.065+2 Ω	1020mA	12.5x15	1	1	UPL1V331MHH6
	50V	470µF	0.046Ω	1470mA	18x15	1	1	UPM1H4711MHH6
Panasonic FC (Surface Mtg)	10V	1000µF	0.043Ω	1205mA	12x16.5	1	1	EEVFC1A102LQ
	35V	330µF	0.065Ω	1205mA	12.5x16	1	1	EEVFC1V331LQ
	16V	330µF	0.150Ω	670mA	10x10.2	N/R	1	EEVFC1C331P
Oscon- SS SV	10V	330µF	0.025Ω	>3500mA	10.0x10.5	1	1	10SS330M
	10V	330µF	0.025Ω	>3800mA	10.3x10.3	1	1	10SV300M
	20V	150µF	0.024+2 Ω	3600mA	10.3x10.3	2	2	20SV150M SV= Surface Mount
AVX Tantalum TPS	10V	330µF	0.100+2 Ω	>2500mA	7.3Lx	2	1	TPSV337M010R0100
	10V	330µF	0.100+2 Ω	>3000mA	4.3Wx	2	1	TPSV337M010R0060
	10V	220µF	0.095Ω	>2000mA	4.1H	2	2	TPSV227M0105R0100
Kemet T510/T495	10V	330µF	0.033Ω	1400mA	7.3Lx5.7W x 4.0H	2	1	T510X337M010AS
	10V	220µF	0.07Ω+2 =0.035Ω	>2000mA		2	2	T495X227M010AS
Sprague 594D	10V	330µF	0.045Ω	2350mA	7.3Lx 6.0Wx	2	1	4D337X0010R2T
	10V	220µF	0.065Ω	>2000mA	4.1H	2	2	594D227X0010D2T

N/R –Not recommended. The voltage rating does not meet the minimum operating limits.

Adjusting the Output Voltage of the PT6935 Dual Output Voltage ISRs

Each output voltage from the PT6935 series of ISRs can be independently adjusted higher or lower than the factory trimmed pre-set voltage. The voltages, V_{O1} and V_{O2} may each be adjusted either up or down using a single external resistor ¹. Table 1 gives the adjustment range for both V_{O1} and V_{O2} for each model in the series as $V_a(\text{min})$ and $V_a(\text{max})$. Note that V_{O2} must always be lower than V_{O1} ².

V_{O1} Adjust Up: To increase the output, add a resistor R4 between pin 16 (V_1 Adjust) and pins 7-11 (GND) ¹.

V_{O1} Adjust Down: Add a resistor (R3), between pin 16 (V_{O1} Adjust) and pin 1 (V_{O1} Sense) ¹.

V_{O2} Adjust Up: Add a resistor R2 between pin 23 (V_{O2} Adjust) and pins 7-11 (GND) ¹.

V_{O2} Adjust Down: Add a resistor (R1) between pin 23 (V_{O2} Adjust) and pin 22 (V_{O2} Sense) ¹.

Refer to Figure 1 and Table 2 for both the placement and value of the required resistor.

Notes:

1. Use only a single 1% resistor in either the (R3) or R4 location to adjust V_{O1} , and in the (R1) or R2 location to adjust V_{O2} . Place the resistor as close to the ISR as possible.
2. V_{O2} must always be at least 0.2V lower than V_{O1} .
3. Both the V_{O1} and V_{O2} may be adjusted down to an alternative bus voltage by making, (R3) or (R1) respectively, a zero ohm link. Refer to the Table 1 footnotes for guidance.

4. Adjusting the V_{O1} output voltage of either the PT6935 (2.5V/1.8V model) or PT6939 (2.5V/1.2V) higher than the factory pre-trimmed output voltage, may increase the minimum input voltage specified for the part. These models must comply with the following requirements.

PT6935/PT6939:

$$V_{in(\text{min})} = (V_a + 0.6)V \text{ or } 3.1V, \text{ whichever is greater.}$$

5. Never connect capacitors to either the V_{O1} Adjust or V_{O2} Adjust pins. Any capacitance added to these control pins will affect the stability of the respective regulated output.
6. Adjusting either voltage (V_{O1} or V_{O2}) may increase the power dissipation in the regulator, and change the maximum current available at either output. Consult the note on p.2 of the data sheet regarding V_{O1}/V_{O2} loading.

The adjust up and adjust down resistor values can also be calculated using the following formulas. Be sure to select the correct formula parameter from Table 1 for the output and model being adjusted.

$$(R1) \text{ or } (R3) = \frac{10(V_a - V_r)}{V_o - V_a} - R_s \quad \text{k}\Omega$$

$$(R2) \text{ or } (R4) = \frac{10 \cdot V_r}{V_a - V_o} - R_s \quad \text{k}\Omega$$

Where: V_o = Original output voltage, (V_{O1} or V_{O2})
 V_a = Adjusted output voltage
 V_r = The reference voltage from Table 1
 R_s = The series resistance from Table 1

Figure 1

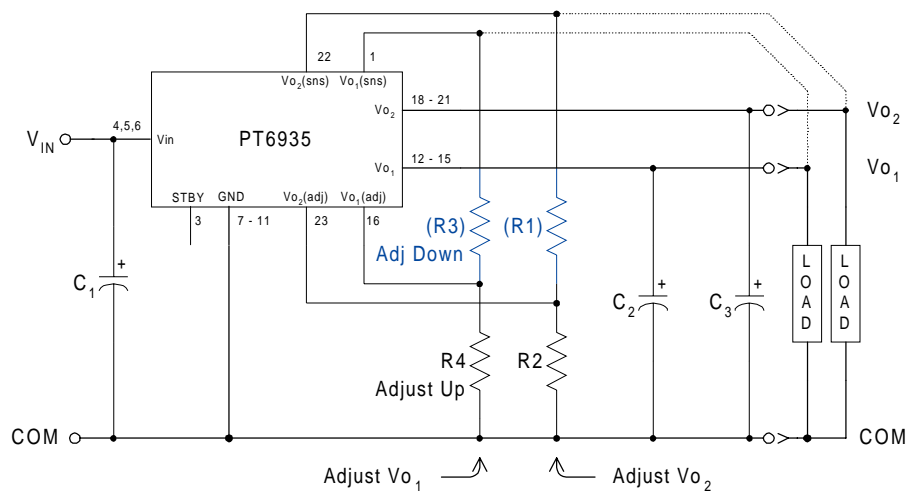

Table 1

ADJUSTMENT RANGE AND FORMULA PARAMETERS

Vo ₁ Bus			Vo ₂ Bus (2)		
Series Pt #	PT6935/39	PT6936/37/38	PT6938/39	PT6935/37	PT6936
Adj. Resistor	(R3)/R4	(R3)/R4	(R1)/R2	(R1)/R2	(R1)/R2
V _o (nom)	2.5V	3.3V	1.2V	1.8V	2.5V
V _a (min)	1.8V *	2.5V *	1.0V †	1.5V †	1.8V †
V _a (max)	3.6V (4)	3.6V	1.5V #	2.4V	3.0
V _r	1.27V	1.27V	0.6125V	1.0V	1.0V
R _s (kΩ)	7.5	15.4	20.0	16.9	11.5

Ref. Note 3: * (R3) = Zero-ohm link
 † (R1) = Zero-ohm link
 # (R2) = Zero-ohm link

Table 2

ADJUSTMENT RESISTOR VALUES

Vo ₁ Bus			Vo ₂ Bus			
Series Pt #	PT6935/39	PT6936/37/38	Series Pt #	PT6938/39	PT6935/37	PT6936
Adj. Resistor	(R3)/R4	(R3)/R4	Adj. Resistor	(R1)/R2	(R1)/R2	(R1)/R2
V _o (nom)	2.5V	3.3V	V _o (nom)	1.2V	1.8V	2.5V
V _a (req'd)			V _a (req'd)			
1.8	(0.0)		1.0	(0.0)kΩ		
1.85	(1.4)kΩ		1.05	(9.2)kΩ		
1.9	(3.0)kΩ		1.1	(28.8)kΩ		
1.95	(4.9)kΩ		1.15	(87.5)kΩ		
2.0	(7.1)kΩ		1.2			
2.05	(9.8)kΩ		1.25	101.5kΩ		
2.1	(13.3)kΩ		1.3	41.2kΩ		
2.2	(23.5)kΩ		1.35	20.8kΩ		
2.3	(44.0)kΩ		1.4	10.6kΩ		
2.4	(106.0)kΩ		1.45	4.5kΩ		
2.5		(0.0)kΩ	1.5	0.0kΩ	(0.0)kΩ	
2.6	120.0kΩ	(3.6)kΩ	1.55		(5.1)kΩ	
2.7	56.0kΩ	(8.4)kΩ	1.6		(13.1)kΩ	
2.8	34.8kΩ	(15.2)kΩ	1.65		(26.4)kΩ	
2.9	24.3kΩ	(25.4)kΩ	1.7		(53.1)kΩ	
3.0	17.9kΩ	(42.3)kΩ	1.75		(133.0)kΩ	
3.1	13.7kΩ	(76.1)kΩ	1.8			(0.0)kΩ
3.2	10.6kΩ	(178.0)kΩ	1.85		183.0kΩ	(1.6)kΩ
3.3	8.4kΩ		1.9		83.1kΩ	(3.5)kΩ
3.4	6.6kΩ	112.0k	1.95		49.8kΩ	(5.8)kΩ
3.5	5.2kΩ	48.1k	2.0		33.1kΩ	(8.5)kΩ
3.6	4.1kΩ	26.9k	2.05		23.1kΩ	(11.8)kΩ
			2.1		16.4kΩ	(16.0)kΩ
			2.2		8.1kΩ	(28.5)kΩ
			2.3		3.1kΩ	(53.5)kΩ
			2.4		0.0kΩ	(129.0)kΩ
			2.5			
			2.6			88.5kΩ
			2.7			38.5kΩ
			2.8			21.8kΩ
			2.9			13.5kΩ
			3.0			8.5kΩ

R₁/R₃ = (Blue), R₂/R₄ = Black

Using the Standby Function on the PT6935 Series of Dual-Output Voltage Regulators

Both output voltages of the 23-pin PT6935 dual-output converter may be disabled using the regulator's 'Standby' function. This function may be used in applications that require power-up/shutdown sequencing, or wherever there is a requirement to control the output voltage On/Off status with external circuitry.

The standby function is provided by the *STBY** control (pin 3). If pin 3 is left open-circuit the regulator operates normally, and provides a regulated output at both V_{O1} (pins 12–15) and V_{O2} (pins 18–21) whenever a valid supply voltage is applied to V_{in} (pins 4, 5, & 6) with respect to GND (pins 7–11). If a low voltage¹ is then applied to pin-3 both regulator outputs will be simultaneously disabled and the input current drawn by the ISR will drop to a typical value of 7mA. The standby control may also be used to hold-off both regulator outputs during the period that input power is applied.

The standby pin is ideally controlled using an open-collector (or open-drain) discrete transistor (See Figure 1). The open-circuit voltage is typically 12.6V. Table 1 gives the circuit parameters for this control input.

Table 1 Standby Control Parameters^{1, 2}

Parameter	Min	Max
Enable (V_{IH})	—	Open circuit
Disable (V_{IL})	-0.1V	0.4V ¹
V_{STBY} (open circuit)	12.6V ²	15V
I_{STBY} (I_{IL})	—	-0.5mA

Notes:

1. The standby control input is Not compatible with TTL or other devices that incorporate a totem-pole output drive. Use only a true open-collector device, preferably a discrete bipolar transistor (or MOSFET). To ensure the regulator output is disabled, the control pin must be pulled to less than 0.4Vdc with a low-level 0.5mA sink to ground.
2. The standby control input requires no external pull-up resistor. The open-circuit voltage of the *STBY** pin is typically 12.6V.
3. When the regulator output is disabled the current drawn from the input source is typically reduced to 7mA.

Figure 1

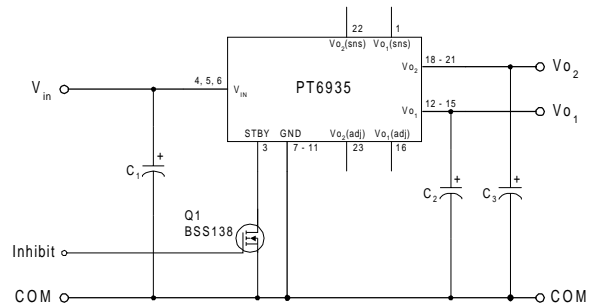

Turn-On Time: Turning Q_1 in Figure 1 off removes the low-voltage signal at pin 3 and enables the PT6935 regulator. Following a delay of about 15ms, V_{O1} and V_{O2} rise together until the lower voltage, V_{O2} , reaches its set output. V_{O1} continues to rise until both outputs reach full regulation voltage. The total power-up time is less than 30ms, and is relatively independent of load, temperature, and output capacitance. Figure 2 shows waveforms of the output voltages, V_{O1} and V_{O2} , for a PT6937 (3.3V/1.8V). The turn-off of Q_1 corresponds to the rise in V_{STBY} . The waveforms were measured with a 5V input voltage, and with resistive loads of 4.5A and 1.9A at the V_{O1} and V_{O2} outputs respectively.

Figure 2

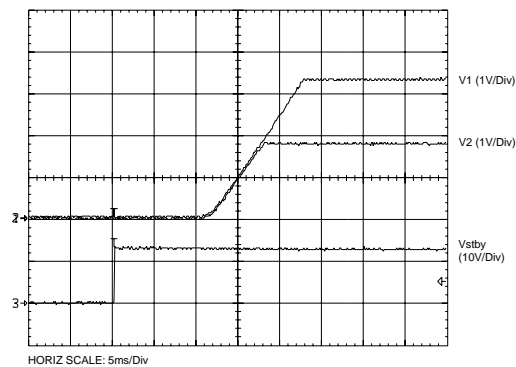

IMPORTANT NOTICE

Texas Instruments Incorporated and its subsidiaries (TI) reserve the right to make corrections, modifications, enhancements, improvements, and other changes to its products and services at any time and to discontinue any product or service without notice. Customers should obtain the latest relevant information before placing orders and should verify that such information is current and complete. All products are sold subject to TI's terms and conditions of sale supplied at the time of order acknowledgment.

TI warrants performance of its hardware products to the specifications applicable at the time of sale in accordance with TI's standard warranty. Testing and other quality control techniques are used to the extent TI deems necessary to support this warranty. Except where mandated by government requirements, testing of all parameters of each product is not necessarily performed.

TI assumes no liability for applications assistance or customer product design. Customers are responsible for their products and applications using TI components. To minimize the risks associated with customer products and applications, customers should provide adequate design and operating safeguards.

TI does not warrant or represent that any license, either express or implied, is granted under any TI patent right, copyright, mask work right, or other TI intellectual property right relating to any combination, machine, or process in which TI products or services are used. Information published by TI regarding third-party products or services does not constitute a license from TI to use such products or services or a warranty or endorsement thereof. Use of such information may require a license from a third party under the patents or other intellectual property of the third party, or a license from TI under the patents or other intellectual property of TI.

Reproduction of information in TI data books or data sheets is permissible only if reproduction is without alteration and is accompanied by all associated warranties, conditions, limitations, and notices. Reproduction of this information with alteration is an unfair and deceptive business practice. TI is not responsible or liable for such altered documentation.

Resale of TI products or services with statements different from or beyond the parameters stated by TI for that product or service voids all express and any implied warranties for the associated TI product or service and is an unfair and deceptive business practice. TI is not responsible or liable for any such statements.

Mailing Address:

Texas Instruments
Post Office Box 655303
Dallas, Texas 75265