

Table of Contents

Thick Film Chips

	Page	
RMC SERIES - General Purpose Thick Film Chip Resistors	1	
RHC SERIES - High Power Thick Film Chip Resistors	3	
RMCP SERIES - General Purpose High Power Thick Film Chip Resistors	5	NEW
RMCS SERIES - Sulfur Resistant Thick Film Chip Resistors	7	
HMC SERIES - High Value Thick Film Chip Resistors	9	
HVC SERIES - High Voltage Thick Film Chip Resistors	11	
RVC SERIES - Medium Voltage Thick Film Chip Resistors	13	
RPC SERIES - Pulse Withstanding Thick Film Chip Resistors	15	
FCR SERIES - Trimmable Thick Film Chip Resistors	17	
RGC SERIES - Semi-Precision Thick Film Chip Resistors	19	

Thin Film SMD Chips

RNC SERIES - Precision Thin Film Chip Resistors	21	
RNCS SERIES - Anti-Corrosive Tantalum Nitride Replacement	23	
RNCP SERIES - High Power Anti-Sulfur Thin Film Chip Resistors	25	NEW
MLF SERIES - Precision Thin Film MELF Resistors	27	

Chip Arrays & Networks

RAV SERIES - Convex Termination Chip Resistor Array	29
RAC SERIES - Concave Termination Chip Resistor Array	31
HVR SERIES - High Voltage Radial Leaded Plate Resistor	33
HVD SERIES - High Voltage Plate Resistor Divider	35

Current Sensing Resistors

CSR / CSRN SERIES - Thick Film Current Sensing Resistors	37	
CSS / CSSH SERIES - Ultra Precision Current Sensing Chip Resistors	39	NEW
CSNL SERIES - Metal Foil Current Sensing Resistors	41	
HLD SERIES - High Current Shunt / Sensing Resistors	43	
MR / TMR SERIES - Low Resistance Value - Molded 2 & 4 Leads	45	
MPR SERIES - Flameproof Metal Plate Resistors	47	
BR SERIES - Bare Element Current Sense Resistors	49	NEW

Axial Leaded Metal and Carbon Resistors

RN / RNM SERIES - General Purpose Metal Film Resistors	51
RS / RSM SERIES - General Purpose Metal Oxide Resistors	53
ASR / ASRM SERIES - Anti-Surge Resistors	55
SPR / SPRM SERIES - Discharge Path Resistors	57
RSPF / RSPL SERIES - Flameproof Power Resistors	59
FRN SERIES - Fusing Resistors	61
MG / MGM SEIRES - High Voltage Metal Glaze Resistors	63
CF / CFM SERIES - Carbon Film Resistors	65
HDM SERIES - Moisture Resistant Carbon Film Resistors	67
RC SERIES - Carbon Composition Resistors	69
JW SERIES - Tin Plated Jumper Wire	72
CD SERIES - Zero Ohm Resistors	73

Table of Contents

Wirewound / Power Resistors		Page
SM SERIES - Surface Mount Wirewound Resistors		75
WW / MWW SERIES - General Purpose and Precision Wirewound Resistors		77
WRF SERIES - Conformal Coated Wirewound Resistors		80
CB SERIES - Ceramic Housed Wirewound with Axial Leads Resistors		81
LCB SERIES - Ceramic Housed for Current Sensing - 2 Leads Resistors		84
TCB SERIES - Ceramic Housed for Current Sensing - 4 Leads Resistors		85
VM / MVM / LVM / WVM SERIES - Ceramic Housed Vertical Mount Resistors		87
RWT SERIES - Thermal Fusing Vertical Mount Wirewound Resistors		89
NSZ SERIES - Ceramic Housed Wirewound PCB Mount Resistors		91
KAL SERIES - Aluminum Housed Surface Mount Resistors		93
SWT / EWT SERIES - Non-Flammable Edgewound Tubular Wirewound Resistors		95
SHP SERIES - Thick Film on Metal Technology		97

NEW

NEW

Special Power Resistors	
HPC SERIES - High Power Surface Mount to 12W	101
TR SERIES - TO-220 Style Power Resistors	103

Packaging and Technical Information	
Dual Power Ratings for Resistors	105
Packaging - Radial Leaded Resistors	106
Packaging - Axial Leaded Resistors	107
Packaging - Arrays	109
Packaging - Chip Resistors	111
Packaging - HPC and SMD Resistors	112
Part Marking Instructions - Chip Resistors	113
General Product Information	114
Standard Color Codes	115
Resistors Glossary	116
EIA Standard Resistor Values	118

Table of Contents

Alphabetical Listing of Products		Page
ASR / ASRM SERIES - Anti-Surge Resistors		55
BR SERIES - Bare Element Current Sense Resistors		49
CB SERIES - Ceramic Housed Wirewound with Axial Leads Resistors		81
CD SERIES - Zero Ohm Resistors		73
CF / CFM SERIES - Carbon Film Resistors		65
CSNL SERIES - Metal Foil Current Sensing Resistors		41
CSR / CSRN SERIES - Thick Film Current Sensing Resistors		37
CSS / CSSH SERIES - Ultra Precision Current Sensing Chip Resistors		39
FCR SERIES - Trimmable Thick Film Chip Resistors		17
FRN SERIES - Fusing Resistors		61
HDM SERIES - Moisture Resistant Carbon Film Resistors		67
HLD SERIES - High Current Shunt / Sensing Resistors		43
HMC SERIES - High Value Thick Film Chip Resistors		9
HPC SERIES - High Power Surface Mount to 12W		101
HVC SERIES - High Voltage Thick Film Chip Resistors		11
HVD SERIES - High Voltage Plate Resistor Divider		35
HVR SERIES - High Voltage Radial Leaded Plate Resistor		33
JW SERIES - Tin Plated Jumper Wire		72
KAL SERIES - Aluminum Housed Surface Mount Resistors		93
LCB SERIES - Ceramic Housed for Current Sensing - 2 Leads Resistors		84
MG / MGM SEIRES - High Voltage Metal Glaze Resistors		63
MLF SERIES - Precision Thin Film MELF Resistors		27
MPR SERIES - Flameproof Metal Plate Resistors		47
MR / TMR SERIES - Low Resistance Value - Molded 2 & 4 Leads		45
NSZ SERIES - Ceramic Housed Wirewound PCB Mount Resistors		91
RAC SERIES - Concave Termination Chip Resistor Array		31
RAV SERIES - Convex Termination Chip Resistor Array		29
RC SERIES - Carbon Composition Resistors		69
RGC SERIES - Semi-Precision Thick Film Chip Resistors		19
RHC SERIES - High Power Thick Film Chip Resistors		3
RMC SERIES - General Purpose Thick Film Chip Resistors		1
RMCP SERIES - General Purpose High Power Thick Film Chip Resistors		5
RMCS SERIES - Sulfur Resistant Thick Film Chip Resistors		7
RN / RNM SERIES - General Purpose Metal Film Resistors		51
RNC SERIES - Precision Thin Film Chip Resistors		21
RNCP SERIES - High Power Anti-Sulfur Thin Film Chip Resistors		25
RNCS SERIES - Anti-Corrosive Tantalum Nitride Replacement		23
RPC SERIES - Pulse Withstanding Thick Film Chip Resistors		15
RS / RSM SERIES - General Purpose Metal Oxide Resistors		53
RSPF / RSPL SERIES - Flameproof Power Resistors		59
RVC SERIES - Medium Voltage Thick Film Chip Resistors		13
RWT SERIES - Thermal Fusing Vertical Mount Wirewound Resistors		89
SHP SERIES - Thick Film on Metal Technology		97
SM SERIES - Surface Mount Wirewound Resistors		75
SPR / SPRM SERIES - Discharge Path Resistors		57
SWT / EWT SERIES - Non-Flammable Edgewound Tubular Wirewound Resistors		95
TCB SERIES - Ceramic Housed for Current Sensing - 4 Leads Resistors		85
TR SERIES - TO-220 Style Power Resistors		103
VM / MVM / LVM / WVM SERIES - Ceramic Housed Vertical Mount Resistors		87
WRF SERIES - Conformal Coated Wirewound Resistors		80
WW / MWW SERIES - General Purpose and Precision Wirewound Resistors		77

NEW

NEW

NEW

NEW

NEW

NEW

- Features:
- ✓ Nickel Barrier terminations standard
 - ✓ Power derating from 100% at 70°C to zero at +155°C
 - ✓ Zero ohm available (max resistance 0.05Ω)
 - ✓ RoHS compliant / lead-free available (RMCF)

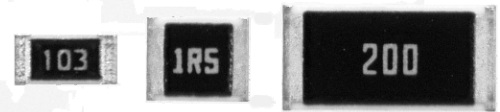

Electrical Specifications								
Type / Code	Package Type	Power Rating (Watts) @ 70°C	Maximum Working Voltage ①	Maximum Overload Voltage	Maximum Current	Resistance Temperature Coefficient	Ohmic Range and Tolerance	
							1%	5%
RMC 1/20	0201	0.050W	25V	50V	1 Amp	± 600 ppm/°C ± 300 ppm/°C ± 200 ppm/°C	1Ω - 9.76Ω 10Ω - 97.6Ω 100Ω - 1MΩ	1Ω - 9.1Ω 10Ω - 91Ω 100Ω - 10MΩ
RMC 1/16S	0402	0.063W	50V	100V	1 Amp	± 200 ppm/°C ± 100 ppm/°C	- 1Ω - 10MΩ	1Ω - 10MΩ -
RMC 1/16	0603	0.100W	50V	100V	1 Amp	± 350 ppm/°C ± 200 ppm/°C ± 100 ppm/°C ± 350 ppm/°C	- 0.1Ω - 9.76Ω 10Ω - 1MΩ 1.02MΩ - 10MΩ	0.1Ω - 9.1Ω 10Ω - 10MΩ - 11MΩ - 22MΩ
RMC 1/10	0805	0.125W	150V	300V	2 Amp	± 350 ppm/°C ± 200 ppm/°C ± 100 ppm/°C ± 350 ppm/°C	- 0.1Ω - 0.976Ω 1Ω - 10MΩ -	0.1Ω - 9.1Ω 10Ω - 10MΩ - 11MΩ - 22MΩ
RMC 1/8	1206	0.250W	200V	400V	2 Amp	± 350 ppm/°C ± 200 ppm/°C ± 100 ppm/°C ± 350 ppm/°C	- 0.1Ω - 0.976Ω 1Ω - 10MΩ -	0.1Ω - 9.1Ω 10Ω - 10MΩ - 11MΩ - 24MΩ
RMC 1/4	1210	0.330W [Ⓢ]	200V	400V	3 Amp	± 350 ppm/°C ± 200 ppm/°C ± 100 ppm/°C ± 350 ppm/°C	- 0.1Ω - 0.976Ω 1Ω - 10MΩ -	0.15Ω - 9.1Ω 10Ω - 10MΩ - 11MΩ - 22MΩ
RMC 1/2	2010	0.750W	200V	400V	3 Amp	± 350 ppm/°C ± 200 ppm/°C ± 100 ppm/°C ± 350 ppm/°C	- 0.1Ω - 0.976Ω 1Ω - 10MΩ -	0.1Ω - 9.1Ω 10Ω - 10MΩ - 11MΩ - 22MΩ
RMC 1	2512	1.000W	200V	400V	3 Amp	± 350 ppm/°C ± 200 ppm/°C ± 100 ppm/°C ± 350 ppm/°C	- 0.1Ω - 0.976Ω 1Ω - 1MΩ -	0.1Ω - 9.1Ω 10Ω - 10MΩ - 11MΩ - 22MΩ

① Lesser of \sqrt{PR} or maximum working voltage.
 ② Power rating is 0.500W for ohmic values below 1KΩ

How to Order

SEI Type		Code	Nominal Resistance	Tolerance	Packaging					
RMC		1/16	4.7K	5%	R					
Type	Description	Code	Wattage	Size	Tolerance	Values	SEI Types	Pkg Qty	Description	Code
RMC	Standard	1/20	0.050W	0201	1%	E96,E24	1/20	15,000	7" reel - Paper	R
RMCF	RoHS	1/16S	0.063W	0402	5%	E24	1/16S	10,000		
		1/16	0.100W	0603			10,000	10" reel - Paper	G	
		1/10	0.125W	0805			5,000	7" reel - Paper	R	
		1/8	0.250W	1206			1,000	Bulk	A	
		1/4	0.330W	1210			4,000	7" - Embossed	R	
		1/2	0.750W	2010						
		1	1.000W	2512						

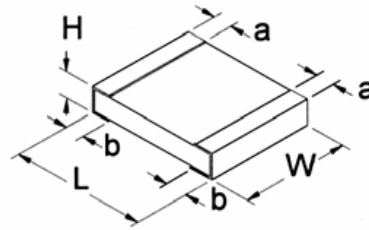

Mechanical Specifications						
Type / Code	L Body Length	W Body Width	H Body Height	a Top Termination	b Bottom Termination	Units
RMC 1/20	0.024 ± 0.001 0.60 ± 0.03	0.011 ± 0.001 0.30 ± 0.03	0.009 ± 0.001 0.23 ± 0.03	0.004 ± 0.002 0.10 ± 0.05	0.006 ± 0.002 0.15 ± 0.05	inches mm
RMC 1/16S	0.039 ± 0.002 1.00 ± 0.05	0.020 ± 0.002 0.50 ± 0.05	0.014 ± 0.002 0.35 ± 0.05	0.008 ± 0.004 0.20 ± 0.10	0.010 +0.002/-0.004 0.25 ± 0.05/-0.10	inches mm
RMC 1/16	0.063 ± 0.004 1.60 ± 0.10	0.031 ± 0.004 0.80 ± 0.10	0.018 ± 0.004 0.45 ± 0.10	0.012 ± 0.008 0.30 ± 0.20	0.012 ± 0.008 0.30 ± 0.20	inches mm
RMC 1/10	0.079 ± 0.008 2.00 ± 0.20	0.049 ± 0.004 1.25 ± 0.10	0.020 ± 0.006 0.50 ± 0.15	0.016 ± 0.008 0.40 ± 0.20	0.016 ± 0.008 0.40 ± 0.20	inches mm
RMC 1/8	0.126 ± 0.008 3.20 ± 0.20	0.063 ± 0.006 1.60 ± 0.15	0.021 ± 0.006 0.55 ± 0.15	0.020 ± 0.010 0.50 ± 0.25	0.020 ± 0.010 0.50 ± 0.25	inches mm
RMC 1/4	0.126 ± 0.008 3.20 ± 0.20	0.098 ± 0.008 2.50 ± 0.20	0.021 ± 0.006 0.55 ± 0.15	0.020 ± 0.010 0.50 ± 0.25	0.020 ± 0.010 0.50 ± 0.25	inches mm
RMC 1/2	0.197 ± 0.008 5.00 ± 0.20	0.098 ± 0.008 2.5 ± 0.20	0.021 ± 0.006 0.55 ± 0.15	0.024 ± 0.010 0.60 ± 0.25	0.024 ± 0.010 0.60 ± 0.25	inches mm
RMC 1	0.248 ± 0.008 6.30 ± 0.20	0.126 ± 0.008 3.20 ± 0.20	0.021 ± 0.006 0.55 ± 0.15	0.024 ± 0.010 0.60 ± 0.25	0.024 ± 0.010 0.60 ± 0.25	inches mm

Note: Lead free (RMCF) dimensions same as standard parts

Performance Characteristics		
Test	Test Conditions (JIS C 5202)	Test Results
Short Time Overload	2.5x rated voltage for 5 seconds	± (2% + 0.1Ω)
Dielectric Withstanding Voltage	100 VAC, 1 minute	± (1% + 0.05Ω)
Resistance to Soldering Heat	260°C ±5°C, for 10 sec. ±0.5 sec. (Solder Bath)	± (1% + 0.05Ω)
Solderability	235°C ±5°C, for 2 sec. ±0.5 sec. (Colophonium flux)	95% coverage, minimum
Temperature Cycle	-65°C: 30 min. 25°C: 2 to 3 min. 155°C: 30 min. 25°C: 2 to 3 min. (5 Cycles)	±(1% + 0.05Ω) Jumper (<0.05Ω)
Endurance (Damp load)	40°C ± 2°C, 90% RH, Rated Load 90 min. On, 30 min. Off for 1,000 hrs. -0hrs./+48hrs.	±(3% + 0.1Ω) Jumper (<0.05Ω)
Endurance (Rated load)	70°C ± 2°C, Rated Load 90 min. On, 30 min. Off for 1,000 hrs. -0hrs./+48hrs.	±(3% + 0.1Ω) Jumper (<0.05Ω)
Voltage Coefficient	1/10 rated voltage for 3 sec. max. then rated voltage for 3 sec. max.	±100 (ppm/V)
Robustness of Termination	Bend of 3mm for 5 ± 1 sec.	± (1% + 0.05 Ohm)

Operating Temperature Range: -65°C to +125°C (0201 size)
-65°C to +155°C (all others)

- Features:
- ✓ Handles 2W of power
 - ✓ Resistances from 0.1Ω to 1MΩ
 - ✓ RoHS compliant / lead-free
 - ✓ TCR of ± 100 ppm/°C
 - ✓ 1% and 5% tolerances
 - ✓ Runs significantly cooler than standard thick film 2512 chip

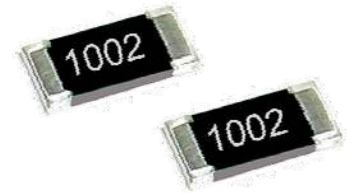

Electrical Specifications							
Type / Code	Package Type	Power Rating (Watts) @ 70°C	Maximum Working Voltage	Maximum Overload Voltage	Resistance Temperature Coefficient	Ohmic Range and Tolerance	
						1%	5%
RHC 2512	2512	2.0W	200V	400V	±100 ppm/°C	0.1Ω - 1MΩ	0.1Ω - 1MΩ

① Lesser of \sqrt{PR} or maximum working voltage.

Performance Characteristics	
Test	Typical
Moisture Resistance	±1%
Load Life	±1%
Resistance to Soldering	±1%
Temperature Cycling	±1%
Thermal Shock	±1%
Short Time Overload	±1%
Insulation Resistance	≥1MΩ

Operating Temperature Range: -55°C to +155°C

Power Derating Curve

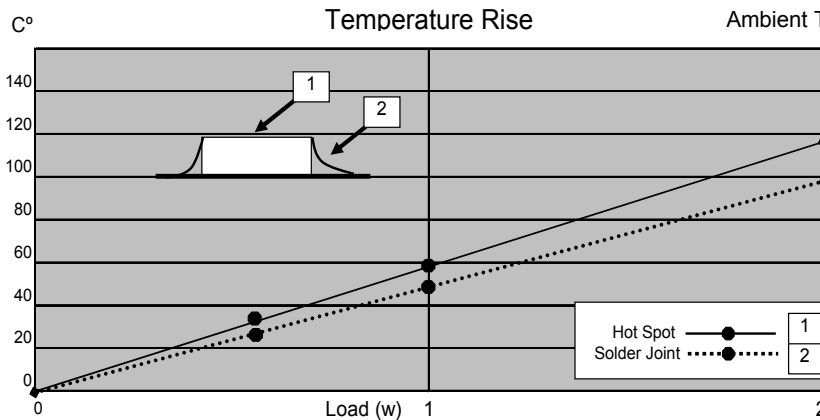
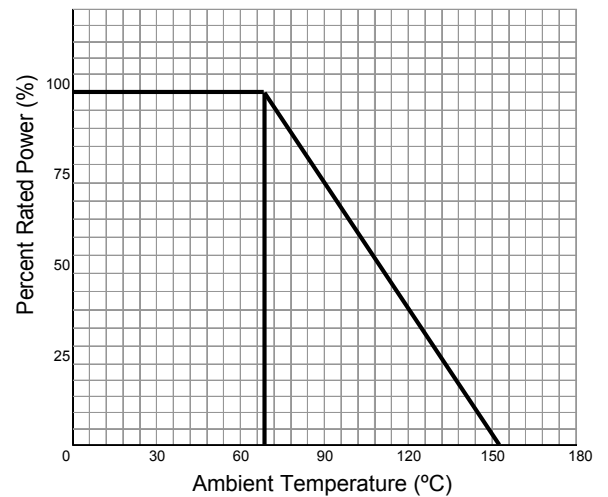

How to Order

SEI Type		Code			Nominal Resistance	Tolerance		Packaging			
RHC		2512			10K	1%		R			
Type	Description	Code	Wattage	Size	Tolerance		Values	SEI Types	Pkg Qty	Description	Code
RHC	High Power	2512	2W	2512	1%	5%	E24	RHC 2512	4,000	7" - Emboss	R

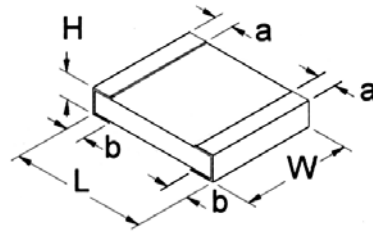

Mechanical Specifications						
Type / Code	L Body Length	W Body Width	H Body Height	a Top Termination	b Bottom Termination	Units
RHC 2512	0.248 ± 0.008	0.126 ± 0.008	0.024 ± 0.004	0.028 ± 0.008	0.087 ± 0.008	inches
	6.30 ± 0.20	3.20 ± 0.20	0.60 ± 0.10	0.70 ± 0.20	2.20 ± 0.20	mm

Solder Pad Dimensions				
Type / Code	L Total Length	W Total Width	D Pad Depth	Units
RHC 2512	0.315	0.138	0.118	inches
	8.00	3.50	3.00	mm

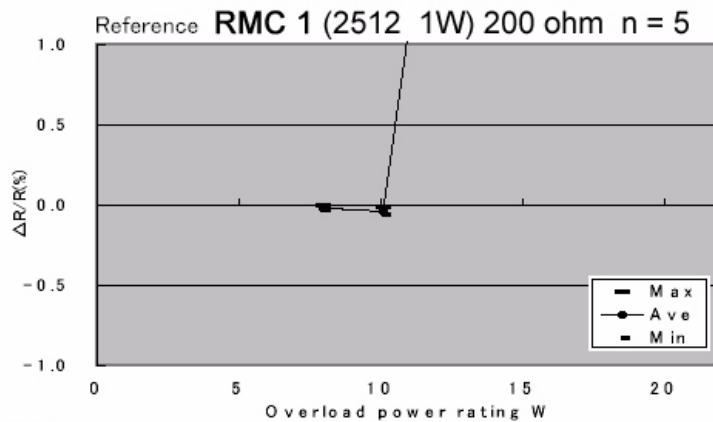
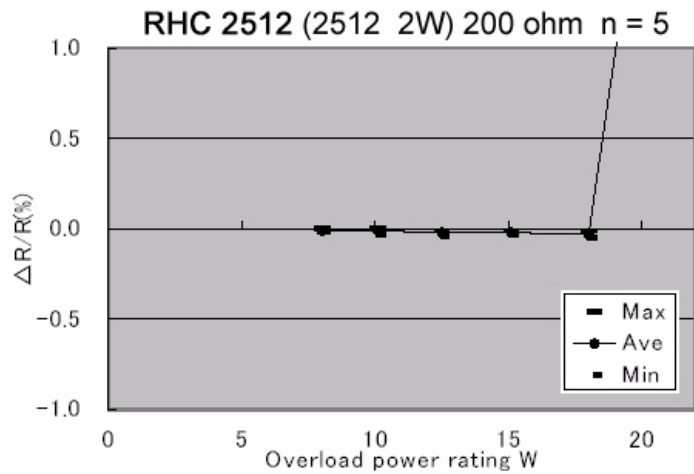
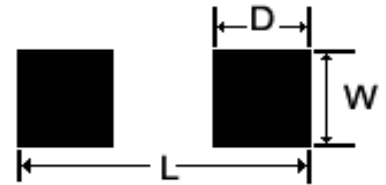

Test condition
Voltage(Power): 2.0, 2.25, 2.5, 2.75, 3.0, 3.25 times of rated voltage. (8W, 10.1W, 12.5W, 15.1W, 18W, 21.1W)
Applied time : Each voltage 5sec
As a reference test, the RMC was tested with the same rated voltage and testing substrate.

RMCP Series

General Purpose High Power Thick Film Chip Resistors

Stackpole Electronics, Inc.

Resistive Product Solutions

- Features:
- ✓ High Power Rating
 - ✓ Nickel Barrier terminations standard
 - ✓ Power derating from 100% at 70°C to zero at +155°C
 - ✓ Zero ohm available (max resistance 0.05Ω)
 - ✓ RoHS compliant

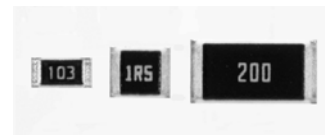

Electrical Specifications								
Type / Code	Package Type	Power Rating (Watts) @ 70°C	Maximum Working Voltage ①	Maximum Overload Voltage	Maximum Current	Resistance Temperature Coefficient	Ohmic Range and Tolerance	
							1%	5%
RMCP 0402	0402	0.100W	50V	100V	1 Amp	± 200 ppm/°C ± 100 ppm/°c ± 200 ppm/°C	1Ω - 9.76Ω 10Ω - 1MΩ 1.02MΩ - 10MΩ	1Ω - 9.76Ω 10Ω - 1MΩ 1.02MΩ - 10MΩ
RMCP 0603	0603	0.125W	50V	100V	1 Amp	± 200 ppm/°C ± 100 ppm/°c ± 200 ppm/°C	1Ω - 9.76Ω 10Ω - 1MΩ 1.02MΩ - 10MΩ	1Ω - 9.76Ω 10Ω - 1MΩ 1.02MΩ - 10MΩ
RMCP 0805	0805	0.250W	150V	300V	2 Amp	± 200 ppm/°C ± 100 ppm/°c ± 200 ppm/°C	1Ω - 9.76Ω 10Ω - 1MΩ 1.02MΩ - 10MΩ	1Ω - 9.76Ω 10Ω - 1MΩ 1.02MΩ - 10MΩ
RMCP 1206	1206	0.333W	200V	400V	2 Amp	± 200 ppm/°C ± 100 ppm/°c ± 200 ppm/°C	1Ω - 9.76Ω 10Ω - 1MΩ 1.02MΩ - 10MΩ	1Ω - 9.76Ω 10Ω - 1MΩ 1.02MΩ - 10MΩ
RMCP 1210	1210	0.500W	200V	400V	3 Amp	± 200 ppm/°C ± 100 ppm/°c ± 200 ppm/°C	1Ω - 9.76Ω 10Ω - 1MΩ 1.02MΩ - 10MΩ	1Ω - 9.76Ω 10Ω - 1MΩ 1.02MΩ - 10MΩ
RMCP 2010	2010	1.000W	200V	400V	3 Amp	± 200 ppm/°C ± 100 ppm/°c ± 200 ppm/°C	1Ω - 9.76Ω 10Ω - 1MΩ 1.02MΩ - 10MΩ	1Ω - 9.76Ω 10Ω - 1MΩ 1.02MΩ - 10MΩ
RMCP 2512	2512	2.000W	200V	400V	3 Amp	± 200 ppm/°C ± 100 ppm/°c ± 200 ppm/°C	1Ω - 9.76Ω 10Ω - 1MΩ 1.02MΩ - 10MΩ	1Ω - 9.76Ω 10Ω - 1MΩ 1.02MΩ - 10MΩ

① Lesser of \sqrt{PR} or maximum working voltage.

How to Order

SEI Type		Code			Nominal Resistance	Tolerance	Packaging			
RMCP		0603			4.7K	5%	R			
Type	Description	Code	Wattage	Size	Tolerance Values		SEI Types	Pkg Qty	Description	Code
RMCP	High Power	0402	0.100W	0402	1%	E96,E24	0402	10,000	7" reel - Paper	R
		0603	0.125W	0603	5%	E24	0603, 0805, 1206, 1210	10,000	10" reel - Paper	G
		0805	0.250W	0805				5,000	7" reel - Paper	R
		1206	0.330W	1206						
		1210	0.500W	1210						
		2010	1.000W	2010						
		2512	2.000W	2512			2010, 2512	4,000	7" reel - Paper	R

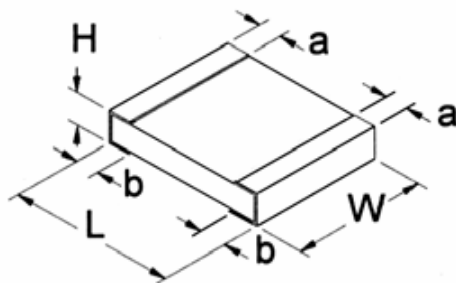

Mechanical Specifications						
Type / Code	L Body Length	W Body Width	H Body Height	a Top Termination	b Bottom Termination	Units
RMCP 0402	0.039 ± 0.002 1.00 ± 0.05	0.020 ± 0.002 0.50 ± 0.05	0.014 ± 0.002 0.35 ± 0.05	0.008 ± 0.004 0.20 ± 0.10	0.010 +0.002/-0.004 0.25 ± 0.05/-0.10	inches mm
RMCP 0603	0.063 ± 0.004 1.60 ± 0.10	0.031 ± 0.004 0.80 ± 0.10	0.018 ± 0.004 0.45 ± 0.10	0.012 ± 0.008 0.30 ± 0.20	0.012 ± 0.008 0.30 ± 0.20	inches mm
RMCP 0805	0.079 ± 0.008 2.00 ± 0.20	0.049 ± 0.004 1.25 ± 0.10	0.020 ± 0.006 0.50 ± 0.15	0.016 ± 0.008 0.40 ± 0.20	0.016 ± 0.008 0.40 ± 0.20	inches mm
RMCP 1206	0.126 ± 0.008 3.20 ± 0.20	0.063 ± 0.006 1.60 ± 0.15	0.021 ± 0.006 0.55 ± 0.15	0.020 ± 0.010 0.50 ± 0.25	0.020 ± 0.010 0.50 ± 0.25	inches mm
RMCP 1210	0.126 ± 0.008 3.20 ± 0.20	0.098 ± 0.008 2.50 ± 0.20	0.021 ± 0.006 0.55 ± 0.15	0.020 ± 0.010 0.50 ± 0.25	0.020 ± 0.010 0.50 ± 0.25	inches mm
RMCP 2010	0.197 ± 0.008 5.00 ± 0.20	0.098 ± 0.008 2.5 ± 0.20	0.021 ± 0.006 0.55 ± 0.15	0.024 ± 0.010 0.60 ± 0.25	0.024 ± 0.010 0.60 ± 0.25	inches mm
RMCP 2512	0.248 ± 0.008 6.30 ± 0.20	0.126 ± 0.008 3.20 ± 0.20	0.021 ± 0.006 0.55 ± 0.15	0.024 ± 0.010 0.60 ± 0.25	0.024 ± 0.010 0.60 ± 0.25	inches mm

Performance Characteristics		
Test	Test Conditions (JIS C 5202)	Test Results
Short Time Overload	2.5x rated voltage for 5 seconds	± (2% + 0.1Ω)
Dielectric Withstanding Voltage	100 VAC, 1 minute	± (1% + 0.05Ω)
Resistance to Soldering Heat	260°C ±5°C, for 10 sec. ±0.5 sec. (Solder Bath)	± (1% + 0.05Ω)
Solderability	235°C ±5°C, for 2 sec. ±0.5 sec. (Colophonium flux)	95% coverage, minimum
Temperature Cycle	-65°C: 30 min. 25°C: 2 to 3 min. 155°C: 30 min. 25°C: 2 to 3 min. (5 Cycles)	±(1% + 0.05Ω) Jumper (<0.05Ω)
Endurance (Damp load)	40°C ± 2°C, 90% RH, Rated Load 90 min. On, 30 min. Off for 1,000 hrs. -0hrs./+48hrs.	±(3% + 0.1Ω) Jumper (<0.05Ω)
Endurance (Rated load)	70°C ± 2°C, Rated Load 90 min. On, 30 min. Off for 1,000 hrs. -0hrs./+48hrs.	±(3% + 0.1Ω) Jumper (<0.05Ω)
Voltage Coefficient	1/10 rated voltage for 3 sec. max. then rated voltage for 3 sec. max.	±100 (ppm/V)
Robustness of Termination	Bend of 3mm for 5 ± 1 sec.	± (1% + 0.05 Ohm)

Operating Temperature Range: -65°C to +125°C (0402 size)
-65°C to +155°C (all others)

- Features:
- ✓ Barrier terminations engineered to deter sulfur contamination
 - ✓ Non-standard resistance values available
 - ✓ Operating temp range from -55°C to +155°C
 - ✓ Zero ohm available (max resistance 0.05Ω)
 - ✓ RoHS compliant / lead-free

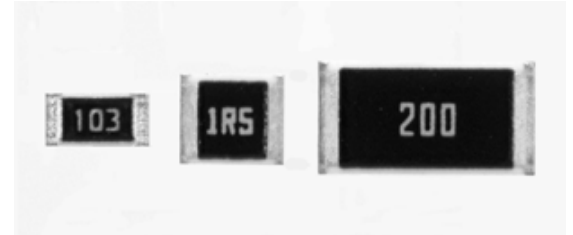

Electrical Specifications								
Type / Code	Package Size	Power Rating (Watts) @ 70°C	Maximum Working Voltage ①	Maximum Overload Voltage	Maximum Current Jumper	Resistance Temperature Coefficient	Ohmic Range and Tolerance	
							1%	5%
RMCS 1/20	0201	0.050W	25V	50V	1 Amp	± 300 ppm/°C ± 200 ppm/°C	10Ω - 97.6Ω 100Ω - 1MΩ	10Ω - 91Ω 100Ω - 10MΩ
RMCS 1/16S	0402	0.063W	50V	100V	1 Amp	± 200 ppm/°C ± 100 ppm/°C ± 200 ppm/°C	10Ω - 97.6Ω 100Ω - 1MΩ 1.02MΩ - 10MΩ	10Ω - 10MΩ - -
RMCS 1/16	0603	0.100W	50V	100V	1 Amp	± 100 ppm/°C ± 200 ppm/°C	10Ω - 1MΩ 1.02MΩ - 10MΩ	- 10Ω - 22MΩ
RMCS 1/10	0805	0.125W	150V	300V	2 Amp	± 100 ppm/°C ± 200 ppm/°C	10Ω - 2.2MΩ 2.21MΩ - 10MΩ	- 10Ω - 22MΩ
RMCS 1/8	1206	0.250W	200V	400V	2 Amp	± 100 ppm/°C ± 200 ppm/°C	10Ω - 1MΩ 1.02MΩ - 10MΩ	- 10Ω - 24MΩ
RMCS 1/4	1210	0.330W	200V	400V	2 Amp	± 100 ppm/°C ± 200 ppm/°C	10Ω - 1MΩ 1.02MΩ - 10MΩ	- 10Ω - 22MΩ
RMCS 1/2	2010	0.750W	200V	400V	2 Amp	± 100 ppm/°C ± 200 ppm/°C	10Ω - 1MΩ -	- 10Ω - 22MΩ
RMCS 1	2512	1.000W	200V	400V	2 Amp	± 100 ppm/°C ± 200 ppm/°C	10Ω - 1MΩ -	- 10Ω - 22MΩ

① Lesser of \sqrt{PR} or maximum working voltage.

How to Order

SEI Type		Code			Nominal Resistance	Tolerance	Packaging			
RMCS		1/16			4.7K	5%	R			
Type	Description	Code	Wattage	Size	Tolerance Values		SEI Types	Pkg Qty	Description	Code
RMCS	Sulfur Resistant	1/20	0.05W	0201	1% E96, E24		1/20	15,000	Tape - 2mm Pitch	R
		1/16S	0.063W	0402	5% E24		1/16S	10,000		
		1/16	0.1W	0603			1/16, 1/10, 1/8	5,000	Paper Tape	
		1/10	0.125W	0805			1/4, 1/2, 1	4,000	Embossed Tape	
		1/8	0.25W	1206			All	1,000	Bulk	A
		1/4	0.33W	1210						
		1/2	0.75W	2010						
		1	1W	2512						

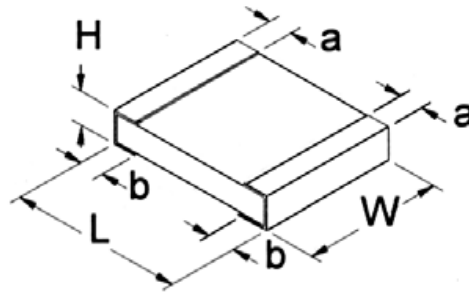

Mechanical Specifications						
Type / Code	L Body Length	W Body Width	H Body Height	a Top Termination	b Bottom Termination	Units
RMCS 1/20	0.024 ± 0.001 0.6 ± 0.03	0.011 ± 0.001 0.3 ± 0.03	0.009 ± 0.001 0.23 ± 0.03	0.004 ± 0.002 0.1 ± 0.05	0.006 ± 0.002 0.15 ± 0.05	inches mm
RMCS 1/16S	0.039 ± 0.002 1 ± 0.05	0.02 ± 0.002 0.5 ± 0.05	0.014 ± 0.002 0.35 ± 0.05	0.008 ± 0.004 0.2 ± 0.1	0.01 ± 0.002/-0.004 0.25 ± 0.05/-0.1	inches mm
RMCS 1/16	0.063 ± 0.004 1.6 ± 0.1	0.031 ± 0.004 0.8 ± 0.1	0.018 ± 0.004 0.45 ± 0.1	0.012 ± 0.008 0.3 ± 0.2	0.012 ± 0.008 0.3 ± 0.2	inches mm
RMCS 1/10	0.079 ± 0.008 2 ± 0.2	0.049 ± 0.004 1.25 ± 0.1	0.020 ± 0.006 0.5 ± 0.15	0.016 ± 0.008 0.4 ± 0.2	0.016 ± 0.008 0.4 ± 0.2	inches mm
RMCS 1/8	0.126 ± 0.008 3.2 ± 0.2	0.063 ± 0.006 1.6 ± 0.15	0.021 ± 0.006 0.55 ± 0.15	0.02 ± 0.01 0.5 ± 0.25	0.02 ± 0.01 0.5 ± 0.25	inches mm
RMCS 1/4	0.126 ± 0.008 3.2 ± 0.2	0.098 ± 0.008 2.5 ± 0.2	0.021 ± 0.006 0.55 ± 0.15	0.02 ± 0.01 0.5 ± 0.25	0.02 ± 0.01 0.5 ± 0.25	inches mm
RMCS 1/2	0.197 ± 0.008 5 ± 0.2	0.098 ± 0.008 2.5 ± 0.2	0.021 ± 0.006 0.55 ± 0.15	0.024 ± 0.01 0.6 ± 0.25	0.024 ± 0.01 0.6 ± 0.25	inches mm
RMCS 1	0.248 ± 0.008 6.3 ± 0.2	0.126 ± 0.008 3.2 ± 0.2	0.021 ± 0.006 0.55 ± 0.15	0.024 ± 0.01 0.6 ± 0.25	0.024 ± 0.01 0.6 ± 0.25	inches mm

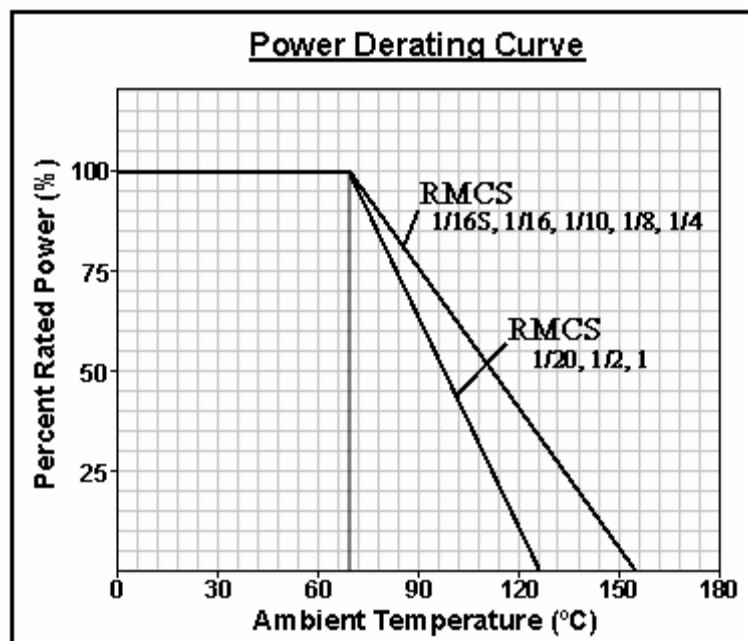

- Features:
- ✓ R Value extension of RMC product
 - ✓ Highly stable performance over time
 - ✓ Power derating from 100% at 70°C to zero at 125°C
 - ✓ E12 and E24 values
 - ✓ Nickel barrier terminations
 - ✓ RoHS compliant / lead-free



Electrical Specifications						
Type / Code	Package Type	Power Rating (Watts) @ 70°C	Maximum Working Voltage [Ⓢ]	Maximum Overload Voltage	Resistance Temperature Coefficient	Ohmic Range and Tolerance
						1%, 5%
HMC 1/20	0201	0.050W	25V	50V	±100 ppm/°C ±400 ppm/°C	1Ω - 10MΩ
HMC 1/16S	0402	0.063W	50V	100V	±100 ppm/°C ±400 ppm/°C	1Ω - 100MΩ
HMC 1/16	0603	0.100W	50V	100V	±100 ppm/°C ±400 ppm/°C	1Ω - 100MΩ
HMC 1/10	0805	0.125W	150V	300V	±100 ppm/°C ±400 ppm/°C	1Ω - 100MΩ
HMC 1/8	1206	0.250W	200V	400V	±100 ppm/°C ±400 ppm/°C	1Ω - 100MΩ
HMC 1/4	1210	0.330W	200V	400V	±100 ppm/°C ±400 ppm/°C	1Ω - 39MΩ
HMC 1/2	2010	0.750W	200V	400V	±100 ppm/°C ±400 ppm/°C	1Ω - 39MΩ
HMC 1	2512	1.000W	250V	500V	±100 ppm/°C ±400 ppm/°C	1Ω - 39MΩ

[Ⓢ] Lesser of \sqrt{PR} or maximum working voltage.

How to Order

SEI Type		Code			Nominal Resistance	Tolerance	Packaging				
HMC		1/10			47M	1%	R				
Type	Description	Code	Wattage	Size		Tolerance	Values	SEI Types	Pkg Qty	Description	Code
HMC	High Value Thick Film	1/20	0.050W	0201		1%	E12, E24	All	5,000	7" - Paper	R
		1/16S	0.063W	0402		5%					
		1/16	0.100W	0603							
		1/10	0.125W	0805							
		1/8	0.250W	1206							
		1/4	0.330W	1210							
		1/2	0.750W	2010							
		1	1.000W	2512							

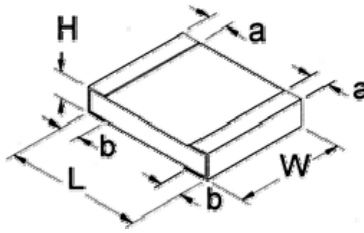

Mechanical Specifications						
Type / Code	L Body Length	W Body Width	H Body Height	a Top Termination	b Bottom Termination	Units
HMC 1/20	0.024 ± 0.001	0.012 ± 0.001	0.009 ± 0.001	0.006 ± 0.002	0.006 ± 0.002	inches
	0.6 ± 0.03	0.3 ± 0.03	0.23 ± 0.03	0.15 ± 0.05	0.15 ± 0.05	mm
HMC 1/16S	0.039 ± 0.002	0.02 ± 0.002	0.014 ± 0.002	0.008 ± 0.004	0.008 ± 0.004	inches
	1 ± 0.05	0.5 ± 0.05	0.35 ± 0.05	0.2 ± 0.1	0.2 ± 0.1	mm
HMC 1/16	0.063 ± 0.004	0.032 ± 0.004	0.018 ± 0.004	0.012 ± 0.008	0.012 ± 0.008	inches
	1.6 ± 0.1	0.8 ± 0.1	0.45 ± 0.1	0.3 ± 0.2	0.3 ± 0.2	mm
HMC 1/10	0.079 ± 0.004	0.049 ± 0.004	0.02 ± 0.004	0.014 ± 0.008	0.016 ± 0.008	inches
	2 ± 0.1	1.25 ± 0.1	0.5 ± 0.1	0.35 ± 0.2	0.4 ± 0.2	mm
HMC 1/8	0.122 ± 0.004	0.061 ± 0.004	0.022 ± 0.004	0.02 ± 0.008	0.02 ± 0.008	inches
	3.1 ± 0.1	1.55 ± 0.1	0.55 ± 0.1	0.5 ± 0.2	0.5 ± 0.2	mm
HMC 1/4	0.126 ± 0.008	0.102 ± 0.006	0.022 ± 0.004	0.02 ± 0.008	0.02 ± 0.008	inches
	3.2 ± 0.2	2.6 ± 0.15	0.55 ± 0.1	0.5 ± 0.2	0.5 ± 0.2	mm
HMC 1/20	0.197 ± 0.008	0.098 ± 0.006	0.022 ± 0.004	0.024 ± 0.01	0.02 ± 0.008	inches
	5 ± 0.2	2.5 ± 0.15	0.55 ± 0.1	0.6 ± 0.25	0.5 ± 0.2	mm
HMC 1	0.25 ± 0.008	0.126 ± 0.006	0.022 ± 0.004	0.024 ± 0.01	0.02 ± 0.008	inches
	6.35 ± 0.2	3.2 ± 0.15	0.55 ± 0.1	0.6 ± 0.25	0.5 ± 0.2	mm

Performance Characteristics		
Test	Test Conditions (JIS C 5202)	Test Results
Long Term Stability	Nominal temperature & humidity for 1,000 hrs.	± 0.5%
High Temperature Loading	15VDC, 1.5 hr. ON, 0.5 hr. OFF, 1,000 hrs. 70°C	± 3%
Resistance to Solder Heat	260°C ± 5°C, 10 seconds +1/-0	± 1%
Short Time Overload	5 seconds at maximum overload voltage	± 2%
Voltage Coefficient of Resistance	Per JIS C 5202	± 0.5%/V

Operating Temperature Range: -55°C to +125°C

- Features:**
- ✓ Absolute voltage ratings up to 25,000 volts
 - ✓ Ohmic values to 50G
 - ✓ Available with wire bondable terminations
 - ✓ Tight tolerances to 0.5%
 - ✓ Utilizes fine film resistor deposition technology
 - ✓ Superior pulse handling capabilities
 - ✓ Low TCR to 25 ppm/°C
 - ✓ Low VCR to 1 ppm/volt
 - ✓ Very low noise
 - ✓ Ultra high stability
 - ✓ Custom sizes available
 - ✓ RoHS compliant / lead-free

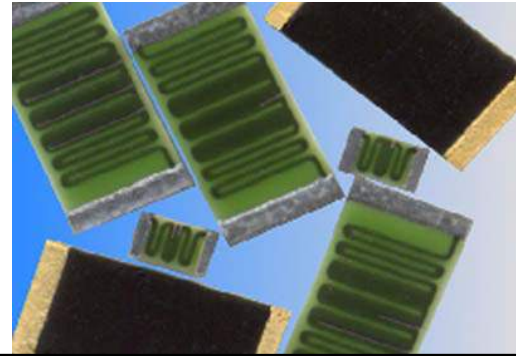

Electrical Specifications

Type	Package Type	Power Rating ³ (Watts) @ 70°C	Maximum Working Voltage ¹	Absolute Maximum Voltage ²	Resistive Temperature Coefficient	Ohmic Range and Tolerance				
						0.5%	1%	2%	5%	10%
HVC 0603	0603	0.100W	400V	5KV	± 50 ppm/°C	10K - 10M	10K - 10M	10K - 500M	10K - 500M	10K - 500M
					± 100 ppm/°C	10K - 10M	10K - 10M	10K - 1G	10K - 1G	10K - 10G
					± 200 ppm/°C	10K - 10M	10K - 10M	10K - 1G	10K - 1G	10K - 10G
					± 300 ppm/°C	10K - 10M	10K - 10M	10K - 1G	10K - 1G	10K - 10G
HVC 0805	0805	0.125W	600V	10KV	± 50 ppm/°C	10K - 10M	10K - 500M	10K - 500M	10K - 500M	10K - 500M
					± 100 ppm/°C	10K - 10M	10K - 1G	10K - 1G	10K - 1G	10K - 1G
					± 200 ppm/°C	10K - 10M	10K - 1G	10K - 1G	10K - 10G	10K - 10G
					± 300 ppm/°C	10K - 10M	10K - 1G	10K - 1G	10K - 10G	10K - 50G
HVC 1206	1206	0.250W	1000V	15KV	± 25 ppm/°C	1M - 100M	1M - 100M	1M - 100M	1M - 100M	1M - 100M
					± 50 ppm/°C	100K - 500M	100K - 500M	100K - 500M	100K - 500M	100K - 500M
					± 100 ppm/°C	100K - 500M	100K - 1G	100K - 1G	100K - 1AG	100K - 1G
					± 200 ppm/°C	100K - 500M	100K - 1G	100K - 10G	100K - 10G	100K - 10G
HVC 2010	2010	0.500W	1,700V	20KV	± 25 ppm/°C	10M - 100M	10M - 100M	10M - 100M	10M - 100M	10M - 100M
					± 50 ppm/°C	100K - 500M	100K - 500M	100K - 500M	100K - 500M	100K - 500M
					± 100 ppm/°C	100K - 500M	100K - 1G	100K - 1G	100K - 1G	100K - 1G
					± 200 ppm/°C	100K - 500M	100K - 1G	100K - 10G	100K - 10G	100K - 10G
HVC 2512	2512	1.000W	2,500V	25KV	± 25 ppm/°C	1M - 500M	1M - 500M	1M - 500M	1M - 500M	1M - 500M
					± 50 ppm/°C	100K - 1G	100K - 1G	100K - 1G	100K - 1G	100K - 1G
					± 100 ppm/°C	10K - 1G	10K - 10G	10K - 10G	10K - 10G	100K - 50G
					± 200 ppm/°C	10K - 1G	10K - 10G	10K - 10G	10K - 10G	100K - 50G
HVC 3512	3512	1.000W	3,500V	40KV	± 25 ppm/°C	1M - 500M	1M - 500M	1M - 500M	1M - 500M	1M - 500M
					± 50 ppm/°C	100K - 1G	100K - 1G	100K - 1G	100K - 1G	100K - 1G
					± 100 ppm/°C	10K - 1G	10K - 10G	10K - 10G	100K - 1G	100K - 50G
					± 200 ppm/°C	10K - 1G	10K - 10G	10K - 10G	10K - 10G	100K - 50G
					± 300 ppm/°C	10K - 1G	10K - 10G	10K - 10G	10K - 10G	100K - 50G
						10K - 1G	10K - 10G	10K - 10G	10K - 10G	100K - 50G
						10K - 1G	10K - 10G	10K - 10G	10K - 10G	100K - 50G
						10K - 1G	10K - 10G	10K - 10G	10K - 10G	100K - 50G

¹ The continuous maximum voltage applied cannot exceed the maximum power rating and is ohmic value dependent.

² To achieve, the terminals must be properly isolated from each other with appropriate potting material.

³ Contact factory for higher power ratings: 0805: 0.2W 1206:0.33W 2010: 1W 2512: 2W

Note: Other case sizes and tolerances are available.

How to Order

SEI Type & Termination		Size	TCR	Nominal Resistance	Tolerance	Packaging			
HVCB		1206	T2	100M	5%	R			
Code	Termination		TCR		Tolerance	SEI Types	Pkg Qty	Description	Code
HVCG	Wire bondable (gold)		T0 = 200ppm		± 0.5%	0603, 0805	5,000	7" reel - Paper	R
HVCS	Solderable single surface		T1 = 100ppm		± 1%		10,000	10" reel - Paper	G
HVCB	100% matte tin		T2 = 50ppm		± 2%		1,000	Bulk	A
HVCZ	Solderable single surface matte tin		T9 = 25ppm		± 5%	1206, 2010, 2512	4,000	7" reel - Emboss	R
					± 10%	2512	1,000	7" reel - Paper	I

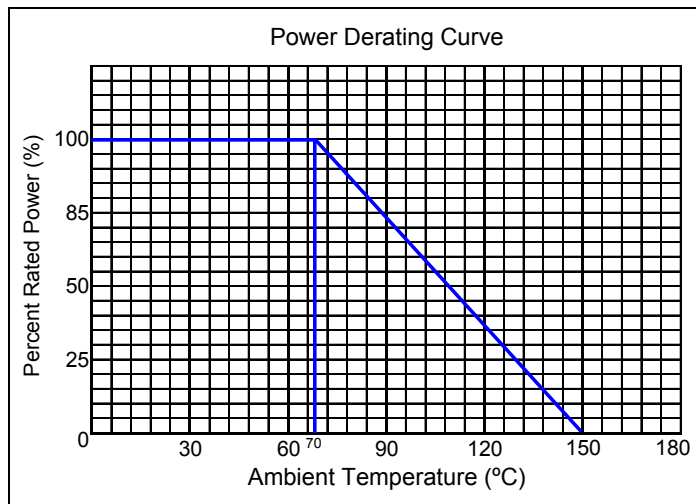
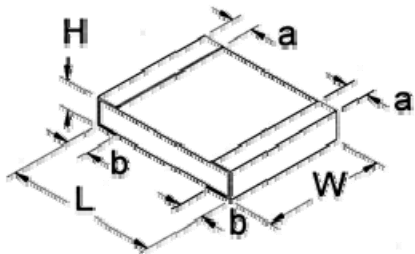

Mechanical Specifications						
Type / Code	L Body Length	W Body Width	H Body Height	a Top Termination	b Bottom Termination	Units
HVC 0603	0.063 ± 0.01/-0.005 1.6 ± 0.25/-0.13	0.031 ± 0.005 0.8 ± 0.13	0.02 0.5	0.01 ± 0.01/-0.005 0.25 ± 0.25/-0.13	0.01 ± 0.01/-0.005 0.25 ± 0.25/-0.13	inches mm
HVC 0805	0.079 ± 0.01/-0.005 2 ± 0.25/-0.13	0.05 ± 0.005 1.25 ± 0.13	0.025 0.64	0.01 ± 0.01/-0.005 0.25 ± 0.25/-0.13	0.01 ± 0.01/-0.005 0.25 ± 0.25/-0.13	inches mm
HVC 1206	0.126 ± 0.01/-0.005 3.2 ± 0.25/0.13	0.061 ± 0.007 1.5 ± 0.18	0.03 0.76	0.015 ± 0.01/-0.005 0.38 ± 0.25/-0.13	0.015 ± 0.01/-0.005 0.38 ± 0.25/-0.13	inches mm
HVC 2010	0.2 ± 0.01/-0.005 5.08 ± 0.25/-0.13	0.100 ± 0.005 2.54 ± 0.13	0.03 0.76	0.02 ± 0.01/-0.005 0.51 ± 0.25/-0.13	0.02 ± 0.01/-0.005 0.51 ± 0.25/-0.13	inches mm
HVC 2512	0.25 ± 0.01/-0.005 6.35 ± 0.25/-0.13	0.125 ± 0.005 3.18 ± 0.13	0.03 0.76	0.02 ± 0.01/-0.005 0.51 ± 0.25/-0.13	0.02 ± 0.01/-0.005 0.51 ± 0.25/-0.13	inches mm
HVC 3512	0.35 ± 0.01/-0.005 8.89 ± 0.25/-0.13	0.125 ± 0.005 3.18 ± 0.13	0.03 0.76	0.02 ± 0.01/-0.005 0.51 ± 0.25/-0.13	0.02 ± 0.01/-0.005 0.51 ± 0.25/-0.13	inches mm

Performance Characteristics		
Test	Test Method	Acceptable Parameter
Load Life	MIL-STD-202G Method 108A Test Condition D	ΔR = 2%
Temperature Cycle (Thermal Shock)	MIL-STD-202G Method 107G Test Condition A	ΔR = 0.02%
Resistance to Soldering Heat	IPC/EIA J-STD-002A Paragraph 4.2.4	IPC/EIA J-STD-002A Paragraph 4.2.4.4
Solderability	IPC/EIA J-STD-002A Paragraph 4.2.2	IPC/EIA J-STD-002A Paragraph 4.2.2.4.2
Short Time Overload	MIL-PRF-55342H Pg. 32, Paragraph 4.8.6	MIL-PRF-55342H Pg 11, Paragraph 3.12

Operating Temperature Range: -55°C to +150°C

- Features:
- ✓ Voltage ratings 2x or more compared to standard chip resistors
 - ✓ Values up to 51M
 - ✓ Proportionally higher pulse power capability
 - ✓ RoHS compliant / lead-free



Electrical Specifications					
Type / Code	Power Rating (Watts) @ 70°C	Limiting Element Voltage	Resistance Temperature Coefficient	Ohmic Range and Tolerance	
				1%	5%, 10%
RVC 0603	0.100W	200V	± 200 ppm/°C ± 100 ppm/°C	47Ω - 464Ω 470Ω - 10MΩ	47Ω - 464Ω 470Ω - 10MΩ
RVC 0805	0.125W	400V	± 200 ppm/°C ± 100 ppm/°C	47Ω - 97.6Ω 100Ω - 10MΩ	47Ω - 97.6Ω 100Ω - 51MΩ
RVC 1206	0.250W	500V	± 200 ppm/°C ± 100 ppm/°C	47Ω - 97.6Ω 100Ω - 10MΩ	47Ω - 97.6Ω 100Ω - 51MΩ
RVC 2010	0.500W	500V	± 200 ppm/°C ± 100 ppm/°C	47Ω - 464Ω 470Ω - 20MΩ	47Ω - 464Ω 470Ω - 51MΩ
RVC 2512	1.500W	800V	± 500 ppm/°C ~ ± 200 ppm/°C ± 200 ppm/°C ± 100 ppm/°C	47Ω - 97.6Ω 100Ω - 549Ω 560Ω - 20MΩ	47Ω - 97.6Ω 100Ω - 549Ω 560Ω - 51MΩ

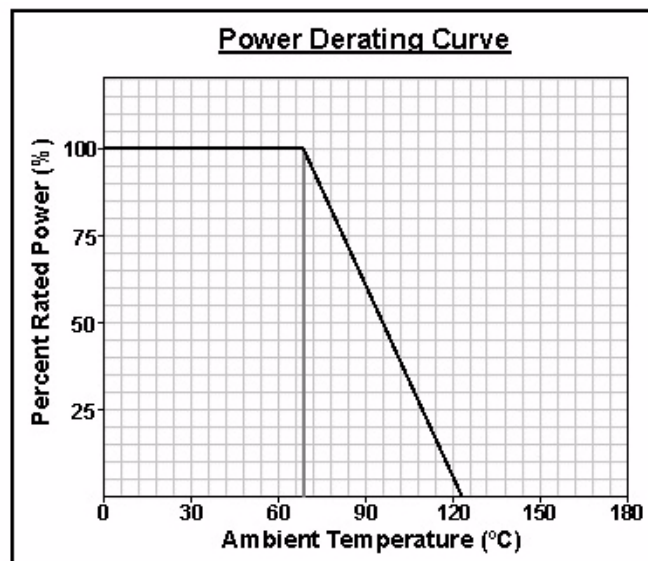

How to Order

SEI Type		Code		Nominal Resistance	Tolerance	Packaging			
RVC		0805		10M	5%	R			
Type	Description	Code	Wattage	Tolerance		SEI Types	Pkg Qty	Description	Code
RVC	Medium Voltage	0603	0.100W	1%		0603, 0805, 1206	5,000	Paper Tape	R
		0805	0.125W	5%					
		1206	0.250W	10%		2010, 2512	4,000	Embossed Tape	
		2010	0.500W						
		2512	1.500W						

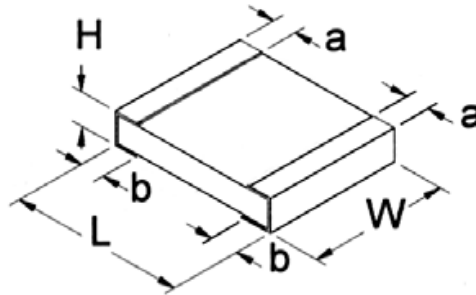

Mechanical Specifications						
Type / Code	L Body Length	W Body Width	H Body Height	a Top Termination	b Bottom Termination	Units
RVC 0603	0.063 ± 0.004 1.60 ± 0.10	0.031 + 0.006/-0.002 0.80 ± 0.15/-0.05	0.018 ± 0.004 0.45 ± 0.10	0.012 ± 0.004 0.30 ± 0.10	0.012 ± 0.004 0.30 ± 0.10	inches mm
RVC 0805	0.079 ± 0.004 2.00 ± 0.10	0.049 ± 0.004 1.25 ± 0.10	0.021 ± 0.004 0.55 ± 0.10	0.016 ± 0.008 0.40 ± 0.20	0.016 ± 0.008 0.40 ± 0.20	inches mm
RVC 1206	0.126 ± 0.006 3.20 ± 0.15	0.063 ± 0.006 1.60 ± 0.15	0.021 ± 0.004 0.55 ± 0.10	0.020 ± 0.010 0.50 ± 0.25	0.020 ± 0.010 0.50 ± 0.25	inches mm
RVC 2010	0.197 ± 0.006 5.00 ± 0.15	0.098 ± 0.006 2.50 ± 0.15	0.021 ± 0.006 0.55 ± 0.15	0.024 ± 0.008 0.60 ± 0.20	0.024 ± 0.008 0.60 ± 0.20	inches mm
RVC 2512	0.248 ± 0.006 6.30 ± 0.15	0.126 ± 0.006 3.20 ± 0.15	0.021 ± 0.006 0.55 ± 0.15	0.024 ± 0.008 0.60 ± 0.20	0.024 ± 0.008 0.60 ± 0.20	inches mm

Performance Characteristics		
Test	Test Conditions (JIS C 5201-1 : 1998)	Test Results
Voltage Proof	Clause 4.7 500Va.c., 60s: RVC 0805, RVC 1206, RVC 2010, RVC 2512 100Va.c., 60s: RVC 0603	No breakdown or flashover R ≥ 1G Ohm
Variation of Resistance with Temperature	Clause 4.8 Measuring temperature: +20°C/ -55°C/ +20°C/ +125°C/ +20°C	See ratings table
Overload	Clause 4.13 The applied voltage shall be 2.5 times of the rated voltage or twice of the limiting element voltage, whichever is the less severe, 2s.	ΔR ≤ ± 1% +0.05Ω No visible damage, legible markings
Solderability	Clause 4.17 235°C, 2s.	In accordance with Clause 4.17.4.5
Resistance to Soldering Heat	Clause 4.18 After immersion into the flux, the immersion into solder shall be carried out in solder bath at 260° for 5s.	ΔR ≤ ± 1% +0.05Ω
Rapid Change of Temperature	Clause 4.19 5 Cycles between -55°C and +125°C	ΔR ≤ ± 1% +0.05Ω No visible damage
Climatic Sequence	Clause 4.23 Dry/Damp heat (12+12h cycle), first cycle/ Cold/Damp heat (12+12h cycle), remaining cycle / D.C. Load	ΔR ≤ ± 5% +0.1Ω No visible damage
Damp Test, Steady State	Clause 4.24 40°C, 95% R.H., 56 days, test a) and b) of Clause 4.24.2.1	ΔR ≤ ± 5% +0.1Ω No visible damage, legible markings
Endurance @ 70°C	Clause 4.25.1 Rated voltage, 1.5h "ON", 0.5h "OFF", 70°C, 1,000h	ΔR ≤ ± 5% +0.1Ω No visible damage
Endurance at the Upper Category Temperature	Clause 4.25.3 125°C, no load, 1,000h	ΔR ≤ ± 5% +0.1Ω No visible damage
Adhesion	Clause 4.32 5N, 10s	No visible damage
Bend of Strength of the Face Plating	Clause 4.33 Amount of bend: 3mm RVC 0603, RVC 0805, RVC 1206 Amount of bend: 1mm RVC 2010, RVC 2512	ΔR ≤ ± 1% +0.05Ω

Operating Temperature Range: -55°C to +125°C

RPC Series

Pulse Withstanding Thick Film Chip Resistor

Stackpole Electronics, Inc.

Resistive Product Solutions

- Features:
- ✓ Excellent pulse withstanding performance
 - ✓ Broad resistance range
 - ✓ Higher anti-surge performance compared with RMC Series
 - ✓ Stability class: 5%
 - ✓ RoHS compliant / lead-free



Electrical Specifications				
Type / Code	Power Rating (Watts) @ 70°C	Maximum Working Voltage [Ⓞ]	Resistance Temperature Coefficient	Ohmic Range and Tolerance 5%, 10%, 20%
RPC 0603	0.100W	50V	±200 ppm/°C	10Ω - 1MΩ
RPC 0805	0.250W	150V	±200 ppm/°C	0.27Ω - 22MΩ
RPC 1206	0.330W	200V	±200 ppm/°C	
RPC 1210	0.500W	200V	±200 ppm/°C	
RPC 2010	0.750W	200V	±200 ppm/°C	
RPC 2512	1.000W	200V	±200 ppm/°C	

Ⓞ Lesser of \sqrt{PR} or maximum working voltage

Ⓜ Higher power rating for each package size is valid if ambient temp ≤ 80°C and terminal temp ≤ 105°C

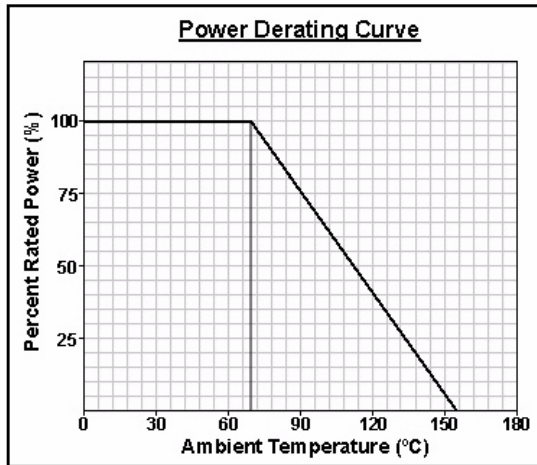

Pulse Limiting Power Curve (100Ω)

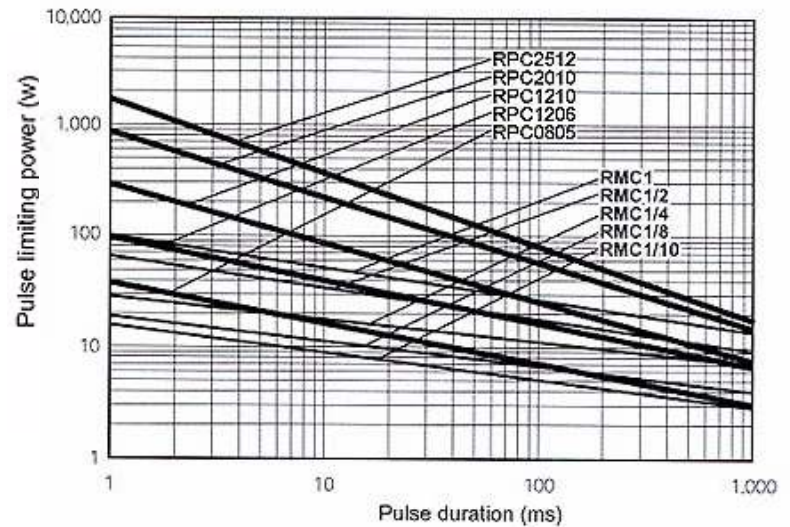

How to Order

SEI Type		Code		Nominal Resistance	Tolerance	Packaging				
RPC		0805		10M	5%	A				
Type	Description	Code	Wattage		Tolerance	Values	SEI Types	Pkg Qty	Description	Code
RPC	Pulse Withstanding	0603	0.100W		5%	E24	0603	5,000	7" Reel - Paper	R
		0805	0.250W		10%		0805, 1206	10,000	10" Reel - Paper	G
		1206	0.330W		20%		1210, 2010, 2512	5,000	7" Reel - Paper	R
		1210	0.500W					4,000		
		2010	0.750W							
		2512	1.000W							

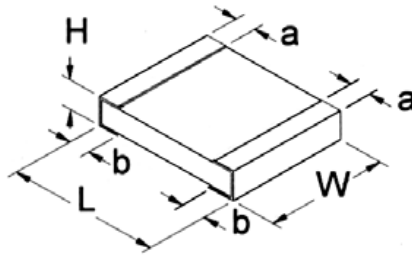

Mechanical Specifications						
Type / Code	L Body Length	W Body Width	H Body Height	a Top Termination	b Bottom Termination	Units
RPC 0603	0.063 ± 0.004 1.60 ± 0.10	0.032 ± 0.004 0.80 ± 0.10	0.018 ± 0.004 0.45 ± 0.10	0.012 ± 0.008 0.30 ± 0.20	0.012 ± 0.008 0.30 ± 0.20	inches mm
RPC 0805	0.079 ± 0.004 2.00 ± 0.10	0.049 ± 0.004 1.25 ± 0.10	0.021 ± 0.004 0.55 ± 0.10	0.012 ± 0.008 0.30 ± 0.20	0.016 ± 0.008 0.40 ± 0.20	inches mm
RPC 1206	0.126 ± 0.006 3.20 ± 0.15	0.063 ± 0.006 1.60 ± 0.15	0.021 ± 0.004 0.55 ± 0.10	0.012 ± 0.008 0.30 ± 0.20	0.020 ± 0.010 0.50 ± 0.25	inches mm
RPC 1210	0.126 ± 0.006 3.20 ± 0.15	0.098 ± 0.006 2.50 ± 0.15	0.021 ± 0.006 0.55 ± 0.15	0.012 ± 0.008 0.30 ± 0.20	0.020 ± 0.010 0.50 ± 0.25	inches mm
RPC 2010	0.197 ± 0.006 5.00 ± 0.15	0.098 ± 0.006 2.50 ± 0.15	0.021 ± 0.006 0.55 ± 0.15	0.012 ± 0.008 0.30 ± 0.20	0.024 ± 0.008 0.60 ± 0.20	inches mm
RPC 2512	0.248 ± 0.006 6.30 ± 0.15	0.126 ± 0.006 3.20 ± 0.15	0.021 ± 0.006 0.55 ± 0.15	0.012 ± 0.008 0.30 ± 0.20	0.024 ± 0.008 0.60 ± 0.20	inches mm

Performance Characteristics		
Test	Test Methods (JIS C 5201-1 : 1198)	Test Results
Voltage Proof	Clause 4.7 500Va.a., 60s	No breakdown or flashover R ≥ 1G Ohm
Variation of Resistance with Temperature	Clause 4.8 +20°C/ -55°C / +20°C/ +125°C/ +20°C: RPC 2010, 2512 +20°C/ -55°C/ +20°C/ +155°C/ +20°C: RPC 0603, 0805, 1206, 1210	See ratings table
Overload	Clause 4.13 The applied voltage shall be 2.5 times of the rated voltage or twice of the limiting element voltage, whichever is the less severe, 2s.	ΔR ≤ ± 1% +0.05Ω No visible damage, legible markings
Solderability	Clause 4.17 235°C, 2s.	In accordance with Clause 4.17.4.5
Resistance to Soldering Heat	Clause 4.18 After immersion into the flux, the immersion into solder shall be carried out in solder bath at 260° for 5s.	ΔR ≤ ± 1% +0.05Ω
Rapid Change of Temperature	Clause 4.19 Cycle: -55°C/ +125°C 5 times: RPC 2010, 2512 Cycle: -55°C/ +155°C 5 times: RPC 0603, 0805, 1206, 1210	ΔR ≤ ± 1% +0.05Ω No visible damage
Climatic Sequence	Clause 4.23 Dry/Damp heat (12+12h cycle), first cycle/ Cold/Damp heat (12+12h cycle), remaining cycle / D.C. Load	ΔR ≤ ± 5% +0.1Ω No visible damage
Damp Test, Steady State	Clause 4.24 40°C, 95% R.H., 56 days, test a) and b) of Clause 4.24.2.1	ΔR ≤ ± 5% +0.1Ω No visible damage, legible markings
Endurance @ 70°C	Clause 4.25.1 Rated voltage, 1.5h "ON", 0.5h "OFF", 70°C, 1,000h	ΔR ≤ ± 5% +0.1Ω No visible damage
Endurance at the Upper Category Temperature	Clause 4.25.3 125°C, no load, 1,000h: RPC 2010, 2512 155°C, no load, 1,000h: RPC 0603, 0805, 1206, 1210	ΔR ≤ ± 5% +0.1Ω No visible damage
Adhesion	Clause 4.32 5N, 10s	No visible damage
Bend of Strength of the Face Plating	Clause 4.33 Amount of bend: 3mm RPC 0603, 0805, 1206, 1210 Amount of bend: 1mm RPC 2010, 2512	ΔR ≤ ± 1% +0.05Ω

Operating Temperature Range: -55°C to +125°C

- Features:
- ✓ YAG laser user-trimmable in circuit
 - ✓ Available in a variety of pre-trim tolerance ranges
 - ✓ TCR of $\pm 200 \text{ ppm}/^\circ\text{C}$
 - ✓ RoHS compliant / lead-free

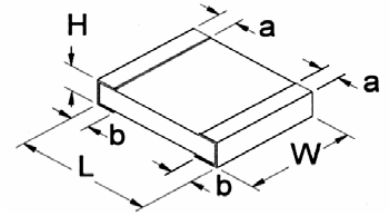

Electrical Specifications										
Type / Code	Package Type	Power Rating (Watts) @ 70°C	Maximum Working Voltage Φ	Maximum Overload Voltage	Resistance Temperature Coefficient	Ohmic Range and Tolerance				
						5%	10%	15%	0/-20%	0/-30%
FCR 1/16S	0402	0.063W	50V	100V	$\pm 200 \text{ ppm}/^\circ\text{C}$	10 Ω - 1M Ω	10 Ω - 1M Ω	10 Ω - 1M Ω	10 Ω - 1M Ω	10 Ω - 1M Ω
FCR 1/16	0603	0.100W	50V	100V	$\pm 200 \text{ ppm}/^\circ\text{C}$	10 Ω - 1M Ω	10 Ω - 1M Ω	10 Ω - 1M Ω	10 Ω - 1M Ω	10 Ω - 1M Ω
FCR 1/10	0805	0.125W	100V	200V	$\pm 200 \text{ ppm}/^\circ\text{C}$	10 Ω - 1M Ω	10 Ω - 1M Ω	10 Ω - 1M Ω	10 Ω - 1M Ω	10 Ω - 1M Ω
FCR 1/8	1206	0.250W	200V	400V	$\pm 200 \text{ ppm}/^\circ\text{C}$	10 Ω - 1M Ω	10 Ω - 1M Ω	10 Ω - 1M Ω	10 Ω - 1M Ω	10 Ω - 1M Ω
FCR 1/4	1210	0.330W	200V	400V	$\pm 200 \text{ ppm}/^\circ\text{C}$	10 Ω - 1M Ω	10 Ω - 1M Ω	10 Ω - 1M Ω	10 Ω - 1M Ω	10 Ω - 1M Ω
FCR 1/2	2010	0.750W	200V	400V	$\pm 200 \text{ ppm}/^\circ\text{C}$	10 Ω - 1M Ω	10 Ω - 1M Ω	10 Ω - 1M Ω	10 Ω - 1M Ω	10 Ω - 1M Ω
FCR 1	2512	1.000W	200V	400V	$\pm 200 \text{ ppm}/^\circ\text{C}$	10 Ω - 1M Ω	10 Ω - 1M Ω	10 Ω - 1M Ω	10 Ω - 1M Ω	10 Ω - 1M Ω

Φ Lesser of $\sqrt{\text{PR}}$ or maximum working voltage.

Mechanical Specifications						
Type / Code	L Body Length	W Body Width	H Body Height	a Top Termination	b Bottom Termination	Units
FCR 1/16S	0.039 \pm 0.002	0.020 \pm 0.002	0.014 \pm 0.002	0.008 \pm 0.004	0.010 + 0.002/ -0.004	inches mm
	1.00 \pm 0.05	0.50 \pm 0.05	0.35 \pm 0.05	0.20 \pm 0.10	0.25 + 0.05/ -0.10	
FCR 1/16	0.063 \pm 0.006	0.031 \pm 0.006	0.018 \pm 0.004	0.012 \pm 0.008	0.012 \pm 0.008	inches mm
	1.60 \pm 0.15	0.80 \pm 0.15	0.45 \pm 0.10	0.30 \pm 0.20	0.30 \pm 0.20	
FCR 1/10	0.079 \pm 0.008	0.050 \pm 0.004	0.020 \pm 0.004	0.016 \pm 0.008	0.016 \pm 0.008	inches mm
	2.00 \pm 0.20	1.25 \pm 0.10	0.50 \pm 0.10	0.40 \pm 0.20	0.40 \pm 0.20	
FCR 1/8	0.126 + 0.002/ -0.008	0.063 + 0.002/ -0.006	0.024 \pm 0.004	0.020 \pm 0.010	0.020 \pm 0.012	inches mm
	3.20 + 0.05/ -0.20	1.60 + 0.05/ -0.15	0.60 \pm 0.10	0.50 \pm 0.25	0.50 \pm 0.30	
FCR 1/4	0.126 \pm 0.008	0.098 + 0.008/ -0.004	0.024 \pm 0.004	0.020 \pm 0.010	0.0220 \pm 0.008	inches mm
	3.20 \pm 0.20	2.50 + 0.20/ -0.10	0.60 \pm 0.10	0.50 \pm 0.25	0.50 \pm 0.20	
FCR 1/2	0.197 \pm 0.006	0.098 \pm 0.006	0.024 \pm 0.004	0.024 \pm 0.010	0.024 \pm 0.010	inches mm
	5.00 \pm 0.15	2.50 \pm 0.15	0.60 \pm 0.10	0.60 \pm 0.25	0.60 \pm 0.25	
FCR 1	0.248 \pm 0.008	0.126 \pm 0.008	0.024 \pm 0.004	0.028 \pm 0.008	0.028 \pm 0.008	inches mm
	6.30 \pm 0.20	3.20 \pm 0.20	0.60 \pm 0.10	0.70 \pm 0.20	0.70 \pm 0.20	

How to Order

SEI Type		Code			Nominal Resistance	Tolerance		Packaging			
FCR		1/10			47K	10%		R			
Type	Description	Code	Wattage	Size	Tolerance		Values	SEI Types	Pkg Qty	Description	Code
FCR	Trimmable	1/16S	0.063W	0402	5%		E24	1/16S	10,000	7" - Paper	R
		1/16	0.100W	0603	10%		E24				
		1/10	0.125W	0805	20%		E24	1/16, 1/10, 1/8, 1/4	5,000	7" - Paper	I
		1/8	0.250W	1206	0/-20%		E24				
		1/4	0.330W	1210	0/-30%		E24	1/2, 1	4,000	7" - Emboss	R
		1/2	0.750W	2010							
		1	1.000W	2512							

Performance Characteristics	
Test	Test Results (JIS C 5202)
Load Life in Moisture	±3%
Temperature Cycle	±1%
Load Life	±3%
Resistance to Solder Heat	±1%
Terminal Adhesion	±1%
Short Time Overload	±2%

Operating Temperature Range: -55°C to +125°C

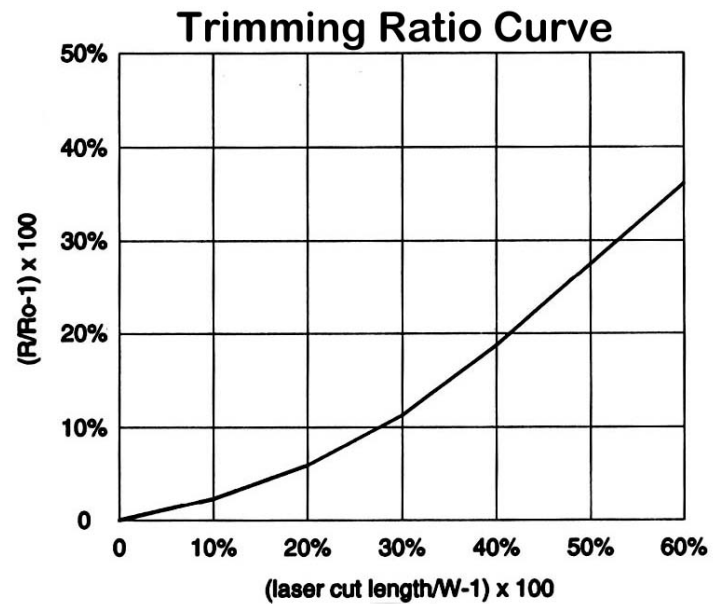
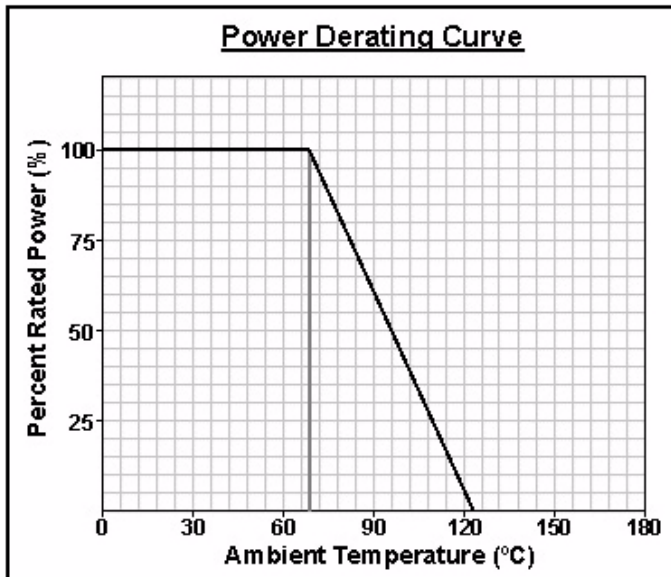

- Features:**
- ✓ Precision performance
 - ✓ Tolerances of +0.5% and ±1%
 - ✓ RoHS compliant / lead-free
 - ✓ Less sensitive to ESD discharges than comparable thin film devices
 - ✓ Highly stable performance over time
 - ✓ Power derating from 100% at 70°C to zero at 150°C
 - ✓ Temperature coefficient of resistance of ±50ppm/°C and ±100ppm/°C

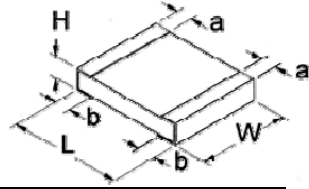

Electrical Specifications							
Type / Code	Package Type	Power Rating (Watts) @ 70°C	Maximum Working Voltage ①	Maximum Overload Voltage	Resistance Temperature Coefficient	Ohmic Range and Tolerance	
						0.5%	1%
RGC 1/16S	0402	0.063W	50V	100V	± 50 ppm/°C ± 100 ppm/°C	10Ω - 97.6Ω 100Ω - 1MΩ	10Ω - 97.6Ω 100Ω - 1MΩ
RGC 1/16	0603	0.100W	50V	100V	± 50 ppm/°C	100Ω - 1MΩ	100Ω - 1MΩ
RGC 1/10	0805	0.125W	150V	300V	± 50 ppm/°C	100Ω - 1MΩ	100Ω - 1MΩ
RGC 1/8	1206	0.250W	200V	400V	± 50 ppm/°C ± 350 ppm/°C	100Ω - 1MΩ	100Ω - 1MΩ

① Lesser of \sqrt{PR} or maximum working voltage.

Mechanical Specifications						
Type / Code	L Body Length	W Body Width	H Body Height	a Top Termination	b Bottom Termination	Units
RGC 1/16S	0.039 ± 0.002 1.00 ± 0.05	0.020 ± 0.002 0.50 ± 0.05	0.014 ± 0.002 0.35 ± 0.05	0.008 ± 0.004 0.20 ± 0.10	0.010 + 0.002/-0.004 0.25 + 0.05/-0.10	inches mm
RGC 1/16	0.063 ± 0.004 1.60 ± 0.10	0.031 ± 0.004 0.80 ± 0.10	0.018 ± 0.004 0.45 ± 0.10	0.012 ± 0.008 0.30 ± 0.20	0.012 ± 0.008 0.30 ± 0.20	inches mm
RGC 1/10	0.079 ± 0.004 2.00 ± 0.10	0.050 ± 0.004 1.25 ± 0.10	0.020 ± 0.004 0.50 ± 0.10	0.016 ± 0.008 0.40 ± 0.20	0.016 ± 0.008 0.40 ± 0.20	inches mm
RGC 1/8	0.126 + 0.002/-0.008 3.20 + 0.05/-0.20	0.063 + 0.002/-0.006 1.60 + 0.05/-0.15	0.024 ± 0.004 0.60 ± 0.10	0.020 ± 0.010 0.50 ± 0.25	0.020 ± 0.08 0.50 ± 0.20	inches mm

Performance Characteristics		
Test	Test Conditions	Test Results
Endurance @ 125°C	125°C, No load, 1,000 hrs.	± 5%
Endurance @ 70°C	Rated Voltage, 1.5 hr. ON, 0.5 hr. OFF, 1,000 hrs. 70°C	± 5%
Resistance to Soldering Heat	260°C ± 5°C, 5 seconds +1/-0	± 1%
Short Time Overload	2 seconds at 2.5 times rated or limiting voltage	± 1%
Voltage Proof	100 volts AC, 60 seconds	No breakdown or flashover R ≥ 1GΩ

Operating Temperature Range: -55°C to +150°C

How to Order

SEI Type	Code	TCR	Nominal Resistance	Tolerance	Packaging																																	
RGC	1/16	T1	4.7K	1%	R																																	
	<table border="1"> <thead> <tr> <th>Code</th> <th>Wattage</th> <th>Size</th> </tr> </thead> <tbody> <tr> <td>1/16S</td> <td>0.063W</td> <td>0402</td> </tr> <tr> <td>1/16</td> <td>0.100W</td> <td>0603</td> </tr> <tr> <td>1/10</td> <td>0.125W</td> <td>0805</td> </tr> <tr> <td>1/8</td> <td>0.250W</td> <td>1206</td> </tr> </tbody> </table>	Code	Wattage	Size	1/16S	0.063W	0402	1/16	0.100W	0603	1/10	0.125W	0805	1/8	0.250W	1206	<table border="1"> <thead> <tr> <th>TCR</th> </tr> </thead> <tbody> <tr> <td>T1 = 100ppm</td> </tr> <tr> <td>T2 = 50ppm</td> </tr> </tbody> </table>	TCR	T1 = 100ppm	T2 = 50ppm	<table border="1"> <thead> <tr> <th>Tolerance</th> <th>Values</th> </tr> </thead> <tbody> <tr> <td>0.5%</td> <td>E96</td> </tr> <tr> <td>1%</td> <td>E96</td> </tr> </tbody> </table>	Tolerance	Values	0.5%	E96	1%	E96	<table border="1"> <thead> <tr> <th>SEI Types</th> <th>Pkg Qty</th> <th>Description</th> <th>Code</th> </tr> </thead> <tbody> <tr> <td>1/16S</td> <td>10,000</td> <td rowspan="2">Paper</td> <td rowspan="2">R</td> </tr> <tr> <td>1/16, 1/10, 1/8</td> <td>5,000</td> </tr> </tbody> </table>	SEI Types	Pkg Qty	Description	Code	1/16S	10,000	Paper	R	1/16, 1/10, 1/8	5,000
Code	Wattage	Size																																				
1/16S	0.063W	0402																																				
1/16	0.100W	0603																																				
1/10	0.125W	0805																																				
1/8	0.250W	1206																																				
TCR																																						
T1 = 100ppm																																						
T2 = 50ppm																																						
Tolerance	Values																																					
0.5%	E96																																					
1%	E96																																					
SEI Types	Pkg Qty	Description	Code																																			
1/16S	10,000	Paper	R																																			
1/16, 1/10, 1/8	5,000																																					

- Features:
- ✓ Precision tolerances to $\pm 0.01\%$
 - ✓ TCR down to $\pm 5\text{ppm}/^\circ\text{C}$
 - ✓ RoHS compliant / lead-free available (RNCF)
 - ✓ E96 and E24 values are standard; E192 are built to order with no part marking
 - ✓ Wide R-value range
 - ✓ Consult factory for tighter tolerances
 - ✓ 2010 and 2512 sizes now available



Electrical Specifications										
Type / Code	Package Size	Power Rating (Watts) @ 70°C	Maximum Working Voltage [Ⓞ]	Maximum Overload Voltage	Resistance Temperature Coefficient	Ohmic Range and Tolerance				
						0.01%	0.05%	0.1%	0.5%	1%
RNC 05	0201	0.032W (0.050W [Ⓢ])	15V	30V	$\pm 25\text{ppm}/^\circ\text{C}$ $\pm 200\text{ppm}/^\circ\text{C}$	-	-	-	33Ω - 22KΩ	100Ω - 1MΩ
RNC 10	0402	0.063W	25V	50V	$\pm 5\text{ppm}/^\circ\text{C}$ $\pm 10\text{ppm}/^\circ\text{C}$ $\pm 25\text{ppm}/^\circ\text{C}$ $\pm 50\text{ppm}/^\circ\text{C}$	49.9Ω - 3K 49.9Ω - 12K - -	49.9Ω - 3K 49.9Ω - 12K - -	49.9Ω - 3K 49.9Ω - 12K 10Ω - 200K 10Ω - 200K	100Ω - 3K 47Ω - 100K 10Ω - 200K 10Ω - 200K	-
RNC 16	0603	0.063W (0.100W [Ⓢ])	75V	100V	$\pm 5\text{ppm}/^\circ\text{C}$ $\pm 10\text{ppm}/^\circ\text{C}$ $\pm 25\text{ppm}/^\circ\text{C}$ $\pm 50\text{ppm}/^\circ\text{C}$	25Ω - 15K 25Ω - 100K - -	25Ω - 15K 25Ω - 100K 4.7Ω - 150K 4.7Ω - 150K	25Ω - 15K 25Ω - 100K 4.7Ω - 1M 2Ω - 1M	- - 2Ω - 1M 2Ω - 1M	-
RNC 20	0805	0.100W (0.125W [Ⓢ])	100V	200V	$\pm 5\text{ppm}/^\circ\text{C}$ $\pm 10\text{ppm}/^\circ\text{C}$ $\pm 25\text{ppm}/^\circ\text{C}$ $\pm 50\text{ppm}/^\circ\text{C}$	25Ω - 30K 25Ω - 200K - -	25Ω - 30K 25Ω - 500K 4.7Ω - 500K 4.7Ω - 500K	25Ω - 30K 4.7Ω - 500K 4.7Ω - 2M 4.7Ω - 2M	- - 1Ω - 2M 1Ω - 2M	-
RNC 32	1206	0.125W (0.250W [Ⓢ])	150V	300V	$\pm 5\text{ppm}/^\circ\text{C}$ $\pm 10\text{ppm}/^\circ\text{C}$ $\pm 25\text{ppm}/^\circ\text{C}$ $\pm 50\text{ppm}/^\circ\text{C}$	25Ω - 50K 25Ω - 500K - -	25Ω - 50K 25Ω - 500K 4.7Ω - 1M 4.7Ω - 1M	25Ω - 50K 4.7Ω - 1M 4.7Ω - 2.5M 4.7Ω - 2.5M	- - 1Ω - 2.5M 1Ω - 2.5M	-
RNC 50	1210	0.200W (0.250W [Ⓢ])	150V	300V	$\pm 5\text{ppm}/^\circ\text{C}$ $\pm 10\text{ppm}/^\circ\text{C}$ $\pm 25\text{ppm}/^\circ\text{C}$ $\pm 50\text{ppm}/^\circ\text{C}$	25Ω - 50K 25Ω - 500K - -	25Ω - 50K 25Ω - 500K 4.7Ω - 1M 4.7Ω - 1M	25Ω - 50K 4.7Ω - 1M 4.7Ω - 2.5M 4.7Ω - 2.5M	- - 1Ω - 2.5M 1Ω - 2.5M	-
RNC 57	2010	0.250W (0.500W [Ⓢ])	150V	300V	$\pm 5\text{ppm}/^\circ\text{C}$ $\pm 10\text{ppm}/^\circ\text{C}$ $\pm 25\text{ppm}/^\circ\text{C}$ $\pm 50\text{ppm}/^\circ\text{C}$	25Ω - 100K 25Ω - 500K - -	25Ω - 100K 25Ω - 500K 4.7Ω - 1M 4.7Ω - 1M	25Ω - 100K 4.7Ω - 1M 4.7Ω - 3M 4.7Ω - 3M	- - 1Ω - 3M 1Ω - 3M	-
RNC 63	2512	0.500W (1.000W [Ⓢ])	150V	300V	$\pm 5\text{ppm}/^\circ\text{C}$ $\pm 10\text{ppm}/^\circ\text{C}$ $\pm 25\text{ppm}/^\circ\text{C}$ $\pm 50\text{ppm}/^\circ\text{C}$	25Ω - 100K 25Ω - 500K - -	25Ω - 100K 25Ω - 500K 4.7Ω - 1M 4.7Ω - 1M	25Ω - 100K 4.7Ω - 1M 4.7Ω - 3M 4.7Ω - 3M	- - 1Ω - 3M 1Ω - 3M	-

Ⓞ Lesser of $\sqrt{\text{PR}}$ or maximum working voltage.

Ⓢ Higher power rating for each package size is valid if ambient temp $\leq 80^\circ\text{C}$ and terminal temp $\leq 105^\circ\text{C}$

How to Order

SEI Type		Code			TCR		Nominal Resistance	Tolerance	Packaging					
RNC		20			T9		4.75K	0.5%	R					
Type	Description	Code	Wattage	Size	TCR			Tolerance	Values		SEI Types	Pkg Qty	Code	Description
RNC	Standard	05	0.050W	0201	T1	100ppm		0.01%	E192 [Ⓢ] , E96, E24		5, 10	10,000	R	7" reel
RNCF	RoHS	10	0.063W	0402	T2	50ppm		0.05%	E192 [Ⓢ] , E96, E24		16, 20, 30	5,000	R	
		16	0.100W	0603	T9	25ppm		0.10%	E192 [Ⓢ] , E96, E24		50	1,000	I	
		20	0.125W	0805	TB	10ppm		0.50%	E192 [Ⓢ] , E96, E24			5,000	R	
		32	0.250W	1206	TA	5ppm		1.00%	E96, E24		57, 63	4,000	R	
		50	0.250W	1210				5.00%	E24			1,000	I	
		57	0.500W	2010										
		63	1.000W	2512										

Ⓢ non-standard

Mechanical Specifications

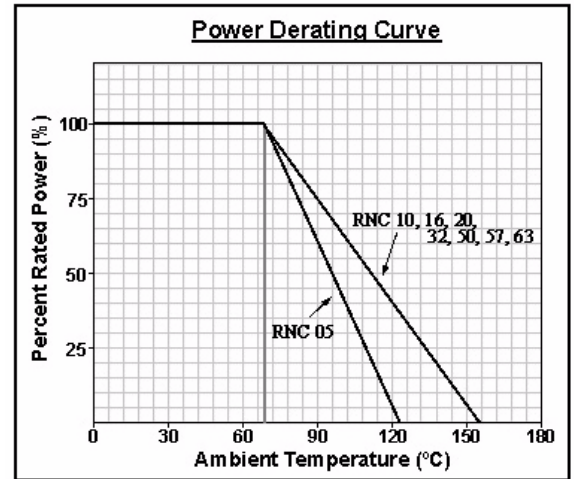
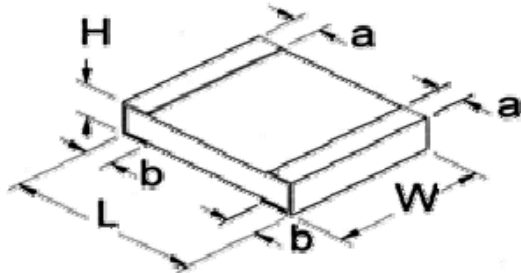

Mechanical Specifications						
Type / Code	L Body Length	W Body Width	H Body Height	a Top Termination	b Bottom Termination	Units
RNC 05	0.024 ± 0.002 0.60 ± 0.05	0.012 ± 0.002 0.30 ± 0.05	0.009 ± 0.001 0.23 ± 0.030	0.005 ± 0.002 0.12 ± 0.05	0.005 ± 0.002 0.12 ± 0.05	inches mm
RNC 10	0.039 ± 0.002 1.00 ± 0.05	0.020 ± 0.002 0.50 ± 0.05	0.014 ± 0.002 0.35 ± 0.05	0.008 ± 0.004 0.20 ± 0.10	0.010 ± 0.002 0.25 ± 0.10	inches mm
RNC 16	0.063 ± 0.008 1.60 ± 0.20	0.032 ± 0.008 0.80 ± 0.20	0.016 ± 0.004 0.40 ± 0.10	0.012 ± 0.008 0.30 ± 0.20	0.012 ± 0.008 0.30 ± 0.20	inches mm
RNC 20	0.079 ± 0.008 2.00 ± 0.20	0.049 ± 0.008 1.25 ± 0.20	0.016 ± 0.004 0.40 ± 0.10	0.016 ± 0.008 0.40 ± 0.20	0.016 ± 0.008 0.40 ± 0.20	inches mm
RNC 32	0.126 ± 0.008 3.20 ± 0.20	0.063 ± 0.008 1.60 ± 0.20	0.020 ± 0.004 0.50 ± 0.10	0.020 ± 0.012 0.50 ± 0.30	0.016 ± 0.008 0.40 ± 0.20	inches mm
RNC 50	0.122 ± 0.006 3.10 ± 0.20	0.090 ± 0.006 2.40 ± 0.15	0.024 ± 0.004 0.60 ± 0.10	0.020 ± 0.012 0.50 ± 0.30	0.016 ± 0.008 0.40 ± 0.20	inches mm
RNC 57	0.193 ± 0.006 4.90 ± 0.15	0.090 ± 0.006 2.40 ± 0.15	0.024 ± 0.004 0.60 ± 0.10	0.024 ± 0.012 0.60 ± 0.30	0.020 ± 0.010 0.50 ± 0.25	inches mm
RNC 63	0.246 ± 0.006 6.30 ± 0.15	0.122 ± 0.006 3.10 ± 0.15	0.024 ± 0.004 0.60 ± 0.10	0.024 ± 0.012 0.60 ± 0.30	0.020 ± 0.010 0.50 ± 0.25	inches mm

Performance Characteristics (JIS C 5202)		
Test	Specification	Typical
Moisture Resistance, Thermal Shock	±(0.25% + 0.05Ω)	≤0.1%
Load Life	±(0.5% + 0.05Ω)	≤0.2%
Load Life in Moisture	±(0.5% + 0.05Ω)	≤0.25%
Resistance to Soldering Heat	±(0.25% + 0.05Ω)	≤0.5%
Solderability	Min 95% coverage	≥0.95%
Terminal Strength	±(0.2% + 0.05Ω)	≤0.05%
Dielectric Withstanding Voltage	±(0.25% + 0.05Ω)	≤0.05%
Short Time Overload	±(0.25% + 0.05Ω)	≤0.05%
Insulation Resistance	1GΩ minimum	≥1GΩ

Operating Temperature Range: -55°C to +125°C (0201);
-55°C to +155°C (0402 to 2512)

RNCS Series

Anti-Corrosive Tantalum Nitride Replacement

Stackpole Electronics, Inc.

Resistive Product Solutions

- Features:
- ✓ Special Passivation for moisture sensitive applications
 - ✓ Absolute TCR's to ± 25 ppm/°C
 - ✓ Available in industry standard sizes from 0402 to 2512
 - ✓ E192 value is built to order with no part marking
 - ✓ Resistance range from 10 Ω to 1M Ω
 - ✓ Test proven immunity to humidity and moisture corrosion
 - ✓ Absolute tolerances to 0.1%
 - ✓ Ideal replacement for costly Tantalum Nitride resistors
 - ✓ RoHS compliant / lead-free



The RNCS series employs a special manufacturing process to ensure high precision, ultra stable performance, and long life in the harshest environments. In moisture comparison testing, the RNCS series outperformed Nichrome Chip Resistors and demonstrated the anti-corrosive claims characterized by Tantalum Nitride resistor products.

Electrical Specifications							
Type / Code	Package Size	Power Rating (Watts) @ 70°C	Maximum Working Voltage ^①	Maximum Overload Voltage	Resistance Temperature Coefficient	Resistance Range	Resistance Tolerance
RNCS 10	0402	0.063W	25V	50V	± 50 ppm/°C ± 25 ppm/°C	10 Ω - 25K Ω	$\pm 0.1\%$ $\pm 0.25\%$ $\pm 0.5\%$
RNCS 16	0603	0.063W (0.100W ^②)	50V	100V	± 50 ppm/°C ± 25 ppm/°C	25 Ω - 332K Ω	$\pm 0.1\%$ $\pm 0.25\%$ $\pm 0.5\%$
RNCS 20	0805	0.100W (0.125W ^②)	100V	200V	± 50 ppm/°C ± 25 ppm/°C	10 Ω - 800 Ω	$\pm 0.1\%$ $\pm 0.25\%$ $\pm 0.5\%$
RNCS 32	1206	0.125W (0.250W ^②)	150V	300V	± 50 ppm/°C ± 25 ppm/°C	10 Ω - 1M Ω	$\pm 0.1\%$ $\pm 0.25\%$ $\pm 0.5\%$
RNCS 57	2010	0.250W (0.500W ^②)	150V	300V	± 50 ppm/°C ± 25 ppm/°C	10 Ω - 1M Ω	$\pm 0.1\%$ $\pm 0.25\%$ $\pm 0.5\%$
RNCS 63	2512	0.500W (1.000W ^②)	150V	300V	± 50 ppm/°C ± 25 ppm/°C	10 Ω - 1M Ω	$\pm 0.1\%$ $\pm 0.25\%$ $\pm 0.5\%$

① Lesser of \sqrt{PR} or maximum working voltage.

② Higher power rating for each package size is valid if ambient temp $\leq 80^\circ\text{C}$ and terminal temp $\leq 105^\circ\text{C}$

How to Order

SEI Type		Code			TCR		Nominal Resistance	Tolerance		Packaging				
RNCS		20			T9		4.75K	0.5%		R				
Type	Description	Code	Wattage	Size	TCR		Tolerance		Values		SEI Types	Pkg Qty	Code	Description
RNCS	Anti-corrosive Titanium-Nitride Replacement	10	0.063W	0402	T2	50ppm		$\pm 0.1\%$	E96, E24, E192 ^①	10	10,000	R	7" reel	
		16	0.100W	0603	T9	25ppm		$\pm 0.25\%$	E96, E24, E192 ^①	16, 20, 32	5,000	R		
		20	0.125W	0805				$\pm 0.5\%$	E96, E24, E192 ^①		1,000	I		
		32	0.250W	1206							4,000	R		
		57	0.500W	2010							1,000	I		
		63	1.000W	2512										

① Non-standard

Mechanical Specifications

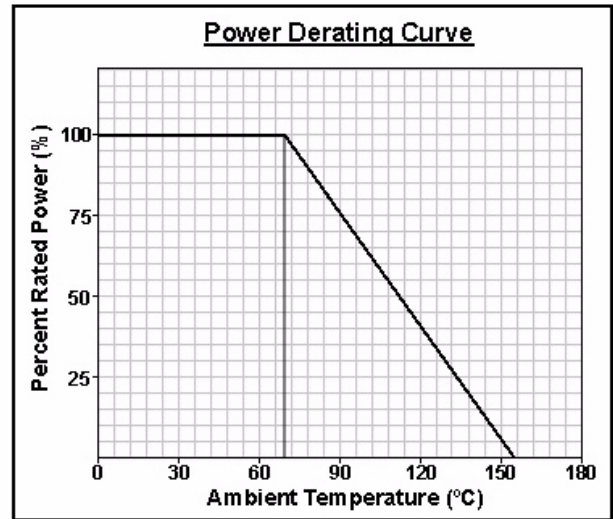
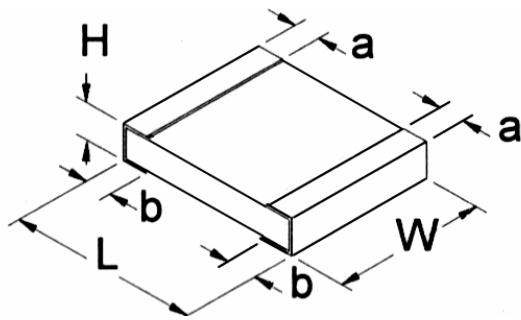

Mechanical Specifications						
Type / Code	L Body Length	W Body Width	H Body Height	a Top Termination	b Bottom Termination	Units
RNCS 10	0.039 ± 0.002	0.020 ± 0.002	0.012 ± 0.002	0.008 ± 0.004	0.008 ± 0.002	inches
	1.00 ± 0.05	0.50 ± 0.05	0.30 ± 0.05	0.20 ± 0.10	0.20 ± 0.10	mm
RNCS 16	0.061 ± 0.008	0.032 ± 0.008	0.018 ± 0.004	0.012 ± 0.008	0.012 ± 0.008	inches
	1.55 ± 0.20	0.80 ± 0.20	0.45 ± 0.10	0.30 ± 0.20	0.30 ± 0.20	mm
RNCS 20	0.079 ± 0.008	0.049 ± 0.008	0.022 ± 0.004	0.012 ± 0.008	0.016 ± 0.008	inches
	2.00 ± 0.20	1.25 ± 0.20	0.55 ± 0.10	0.30 ± 0.20	0.40 ± 0.20	mm
RNCS 32	0.120 ± 0.008	0.061 ± 0.008	0.022 ± 0.004	0.017 ± 0.012	0.014 ± 0.008	inches
	3.05 ± 0.20	1.55 ± 0.20	0.55 ± 0.10	0.42 ± 0.30	0.35 ± 0.20	mm
RNCS 57	0.193 ± 0.006	0.090 ± 0.006	0.022 ± 0.004	0.024 ± 0.012	0.020 ± 0.010	inches
	4.90 ± 0.15	2.40 ± 0.15	0.55 ± 0.10	0.60 ± 0.30	0.50 ± 0.25	mm
RNCS 63	0.246 ± 0.006	0.122 ± 0.006	0.022 ± 0.004	0.024 ± 0.012	0.020 ± 0.010	inches
	6.30 ± 0.15	3.10 ± 0.15	0.55 ± 0.10	0.60 ± 0.30	0.50 ± 0.25	mm

Performance Characteristics			
Test	Test Conditions	Test Results	
		Size 0603 / 0805 / 1206 2012 / 2512	Size 0402
Short Time Overload	RCWV @ 2.5 or Max Overloading Voltage, 2 seconds	≤±0.02%	≤±0.1%
Thermal Shock	MIL - STD - 202F Method 107G -55°C - 125°C, 100 Cycles	≤±0.02%	≤±0.1%
Load Life	MIL - STD - 202F Method 108A RCWV, 70°C, 1.5 hours ON, 0.5 hours OFF, total 1000 - 1048 hours	≤±0.05%	≤±0.25%
Humidity (Steady State)	MIL - STD - 202F Method 103B 40°C, 90-95% RH, RCWV 1.5 hours ON, 0.5 hours OFF, total 1000 - 1048 hours	≤±0.1%	≤±0.5%
Resistance to Dry Heat	JIS - C 5202 - 7.2 1000 hours @ +125°C without load	≤±0.05%	≤±0.5%
Resistance to Soldering Heat	MIL - STD - 202F Method 210E 260 ± 5°C, 10 ± 1 second	≤±0.02%	≤±0.1%

©Storage Temperature: 25 ± 3°C; Humidity <80% RH

RNCP Series

High Power Anti-Sulfur Thin Film Chip Resistor

Stackpole Electronics, Inc.

Resistive Product Solutions

- Features:
- ✓ Higher power ratings than standard thick film chips
 - ✓ Absolute TCRs to $\pm 100\text{ppm}/^\circ\text{C}$
 - ✓ Impervious to Sulfur contamination, no silver present in terminations
 - ✓ Absolute Tolerances to 1%
 - ✓ Completely lead free and RoHS compliant without exemptions – does not use lead containing glass
 - ✓ Comparable in cost to standard thick film chip resistors



Electrical Specifications						
Type / Code	Package Type	Power Rating ² (Watts) @ 70°C	Maximum Working Voltage ¹	Maximum Overload Voltage	Resistance Temperature Coefficient	Ohmic Range and Tolerance
						1% / 2% / 5%
RNCP 0402	0402	0.100W	50V	100V	$\pm 100\text{ ppm}/^\circ\text{C}$	1 Ω - 100K Ω
RNCP 0603	0603	0.125W	75V	150V	$\pm 100\text{ ppm}/^\circ\text{C}$	1 Ω - 360K Ω
RNCP 0805	0805	0.250W	100V	200V	$\pm 100\text{ ppm}/^\circ\text{C}$	1 Ω - 360K Ω
RNCP 1206	1206	0.500W	200V	400V	$\pm 100\text{ ppm}/^\circ\text{C}$	1 Ω - 360K Ω

¹ Lesser of $\sqrt{\text{PR}}$ or maximum working voltage.

² Power rating for each package size is valid if ambient temp $\leq 80^\circ\text{C}$ and terminal temp $\leq 105^\circ\text{C}$.

Performance Characteristics			
Test	Test Conditions	Typical	
		1%	2% / 5%
Short Time Overload	RCWV \odot 2.5 or Max Overload Voltage, 5 seconds	$\pm 1\%$	$\pm 2\%$
Thermal Shock	MIL-STD-202F Method 107G -55°C to +125°C, 1000 Cycles	$\pm 1\%$	$\pm 1\%$
Load Life	MIL-STD-202F Method 108A RCWV, 125°C, 1.5 Hrs ON, 0.5 Hrs OFF, Total 1000 Hrs	$\pm 2\%$	$\pm 3\%$
Humidity (steady state)	MIL-STD-202F Method 103B 85°C, 85% RH, RCWV 1.5Hrs ON, 0.5Hrs OFF, Total 1000Hrs	$\pm 3\%$	$\pm 3\%$
Resistance to Soldering Heat	MIL-STD-202F Method 210E 260 \pm 5°C, 10 \pm 1 second	$\pm 1\%$	$\pm 1\%$

\odot Storage Temperature : 25 \pm 3°C; Humidity < 80% RH

How to Order											
SEI Type		Code			TCR	Nominal Resistance	Tolerance	Packaging			
RNCP		0603			T1	4.75K	1%	R			
Type	Description	Code	Wattage	Size	Code	Tolerance		SEI Types	Pkg Qty	Description	Code
RNCP	High Power Anti-Corrosive	0402	0.100W	0402	T1 = 100ppm	1%		0402	10,000	7" reel - 2mm pitch	R
		0603	0.125W	0603		2%		0603, 0805, 1206	5,000	7" reel - 4mm pitch	R
		0805	0.250W	0805		5%					
		1206	0.500W	1206							

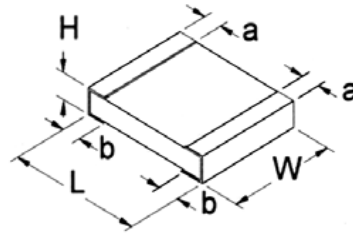

Mechanical Specifications						
Type / Code	L Body Length	W Body Width	H Body Height	a Top Termination	b Bottom Termination	Units
RNCP 0402	0.040 ± 0.004	0.02 ± 0.002	0.012 ± 0.002	0.01 ± 0.006	0.012 ± 0.006	inches
	1.00 ± 0.10	0.50 ± 0.05	0.30 ± 0.05	0.25 ± 0.15	0.30 ± 0.15	mm
RNCP 0603	0.059 ± 0.004	0.032 ± 0.004	0.016 ± 0.004	0.012 ± 0.006	0.016 ± 0.008	inches
	1.50 ± 0.20	0.80 ± 0.10	0.40 ± 0.10	0.30 ± 0.15	0.40 ± 0.20	mm
RNCP 0805	0.079 ± 0.006	0.049 ± 0.006	0.020 ± 0.004	0.018 ± 0.008	0.024 ± 0.008	inches
	2.00 ± 0.15	1.25 ± 0.15	0.50 ± 0.10	0.40 ± 0.20	0.60 ± 0.20	mm
RNCP 1206	0.122 ± 0.008	0.059 ± 0.008	0.020 ± 0.004	0.020 ± 0.012	0.028 ± 0.008	inches
	3.10 ± 0.20	1.50 ± 0.20	0.50 ± 0.10	0.50 ± 0.20	0.70 ± 0.20	mm

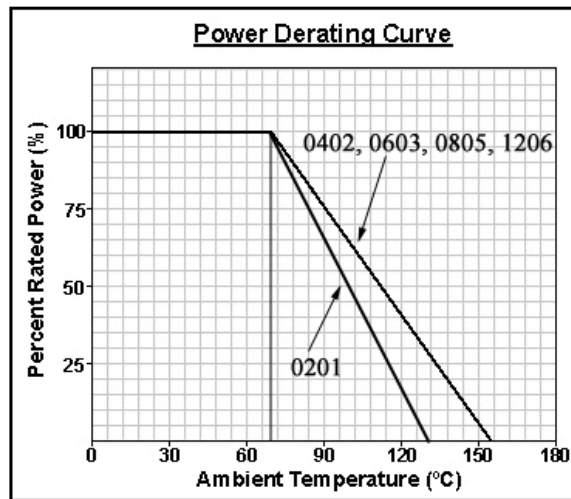

- Features:
- ✓ Thin Film Technology for precision and stability
 - ✓ Excellent power to size ratio
 - ✓ Exhibits good pulse power characteristics
 - ✓ RoHS compliant / lead-free



Electrical Specifications									
Type / Code	Package Size	Power Rating (Watts) @ 70°C	Maximum Working Voltage ^①	Maximum Overload Voltage ^①	Resistance Temperature Coefficient	Ohmic Range and Tolerance			
						0.1%	0.5%	1%	5%
MLF 1/4	0204	0.25W	200V	400V	±10 ppm/°C	100Ω - 20K	10Ω - 20K	-	-
					±15 ppm/°C	100Ω - 100K	10Ω - 100K	-	-
					±25 ppm/°C	100Ω - 270K	4.7Ω - 560K	4.7Ω - 1M	-
					±50 ppm/°C	100Ω - 270K	1Ω - 1M	1Ω - 10M	-
MLF 1/2	0207	0.5W	300V	500V	±10 ppm/°C	100Ω - 20K	100Ω - 20K	10Ω - 20K	-
					±15 ppm/°C	100Ω - 100K	10Ω - 100K	10Ω - 100K	-
					±25 ppm/°C	100Ω - 400K	10Ω - 560K	10Ω - 560K	-
					±50 ppm/°C	100Ω - 400K	1Ω - 1M	1Ω - 5.1M	1Ω - 5.1M
MLFM 1	0207	1W	350V	700V	±15 ppm/°C	100Ω - 100K	10Ω - 100K	10Ω - 100K	-
					±25 ppm/°C	100Ω - 100K	4.7Ω - 1M	4.7Ω - 560K	-
					±50 ppm/°C	100Ω - 100K	1Ω - 10M	1Ω - 2.2M	1Ω - 2.2M
					±50 ppm/°C	100Ω - 100K	1Ω - 10M	1Ω - 2.2M	1Ω - 2.2M

① Lesser of √PR or maximum working voltage.

② Higher power rating for each package size is valid if ambient temp ≤80°C and terminal temp ≤105°C

Mechanical Specifications					
Type / Code	L Body Length	D Body Diameter	L Inner Body	K Termination	Units
MLF 1/4	0.138 ± 0.008	0.055 ± 0.006	0.09	0.020 ± 0.004	inches
	3.50 ± 0.20	1.40 ± 0.15	2.3	0.5 ± 0.10	mm
MLF 1/2 / MLFM 1	0.232 ± 0.008	0.087 ± 0.008	0.185	0.020 ± 0.004	inches
	5.90 ± 0.20	2.20 ± 0.20	4.7	0.5 ± 0.10	mm

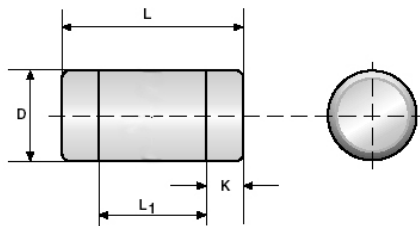

How to Order

SEI Type		Code		TCR		Nominal Resistance		Tolerance		Packaging			
MLF		1/2		T9		4.75K		0.5%		R			
Type	Description	Code	Wattage	TCR				Tolerance	Values	SEI Types	Pkg Qty	Code	Description
MLF	Standard	1/4	0.25W	T1	100ppm			0.1%	E96, E24	MLF 1/4	3,000	R	7" reel
MLFM	Mini	1/2	0.5W	T2	50ppm			0.5%	E96, E24				
		1	1W	T9	25ppm			1%	E96, E24				
				TB	10ppm			5%	E24				

Performance Characteristics	
Test	Specification
Load Life	±2%
Load Life in Moisture	±2%
Resistance to Soldering Heat	±0.5%
Solderability	Min 95% coverage
Short Time Overload	±0.5%
Insulation Resistance	1GΩ minimum

Operating Temperature Range: -55°C to +155°C

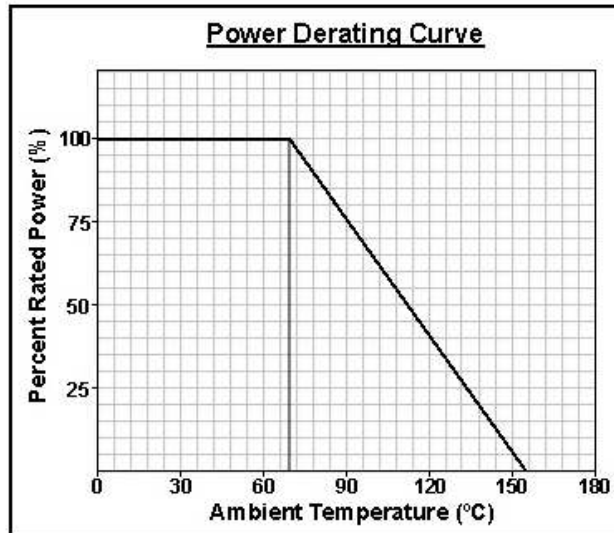

- Features:
- ✓ Thick film resistor element
 - ✓ Multiple circuit types available
 - ✓ Ideal SMD substitute for leaded networks
 - ✓ RoHS compliant / lead-free available (RAVF)
 - ✓ Auto-placement capability
 - ✓ Square corner construction standard
 - ✓ Zero ohm jumper available
 - ✓ RAV 324D is standard with scalloped corner



Electrical Specifications							
Type / Code / # of Elements / Circuit Type	Power Rating (per element) @ 70°C	Power Rating (Entire Array) @ 70°C	Maximum Working Voltage [ⓐ]	Maximum Overload Voltage	Resistance Temperature Coefficient	Ohmic Range and Tolerance	
						1%	2%, 5%
RAV 102D	0.063W	0.125W	25V	50V	±200 ppm/°C ±300 ppm/°C	10Ω - 1MΩ -	10Ω - 1MΩ 1Ω - 9.9Ω
RAV 104D	0.063W	0.250W	25V	50V	±200 ppm/°C ±300 ppm/°C	10Ω - 1MΩ -	10Ω - 1MΩ 1Ω - 9.9Ω
RAV 162D	0.063W	0.125W	50V	100V	±200 ppm/°C	10Ω - 1MΩ	1Ω - 10MΩ
RAV 164D	0.063W	0.250W	50V	100V	±200 ppm/°C	10Ω - 1MΩ	1Ω - 10MΩ
RAV 168D	0.063W	0.500W	25V	50V	±200 ppm/°C ±250 ppm/°C	10Ω - 1MΩ -	- 1Ω - 1MΩ
RAV 324D	0.125W	0.250W	200V	400V	±200 ppm/°C	22Ω - 1MΩ	10Ω - 1MΩ
RAV 328N	0.063W	0.500W	25V	50V	±200 ppm/°C	-	22Ω - 1MΩ
RAV 328R	0.063W	0.500W	25V	50V	±200 ppm/°C	-	22Ω - 1MΩ

[ⓐ] Lesser of \sqrt{PR} or maximum working voltage.

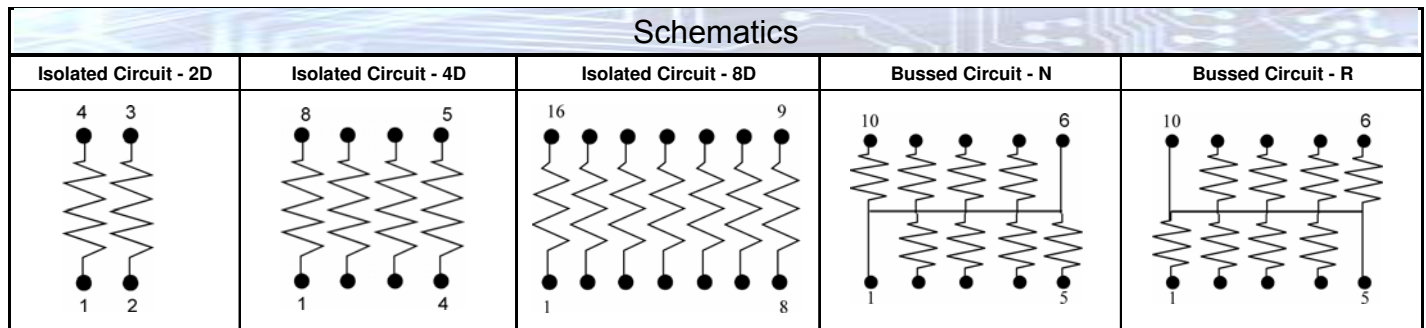

How to Order

SEI Type	Code	Number of Elements	Circuit Type	Nominal Resistance	Tolerance	Packaging				
RAV	16	4	D	10K	5%	R				
Type	Description	Code	Elements	Circuit Type	Tolerance	Values	SEI Types	Pkg Qty	Description	Code
RAV	Convex	10	2	D = Isolated	1%	E24	102D, 104D	10,000	Reel	R
RAVF	Convex RoHS	16	4	N = Bussed	2%	E24	162D, 164D, 168D, 328N, 328R	5,000		
		32	8	R = Bussed	5%	E24	324D	4,000		

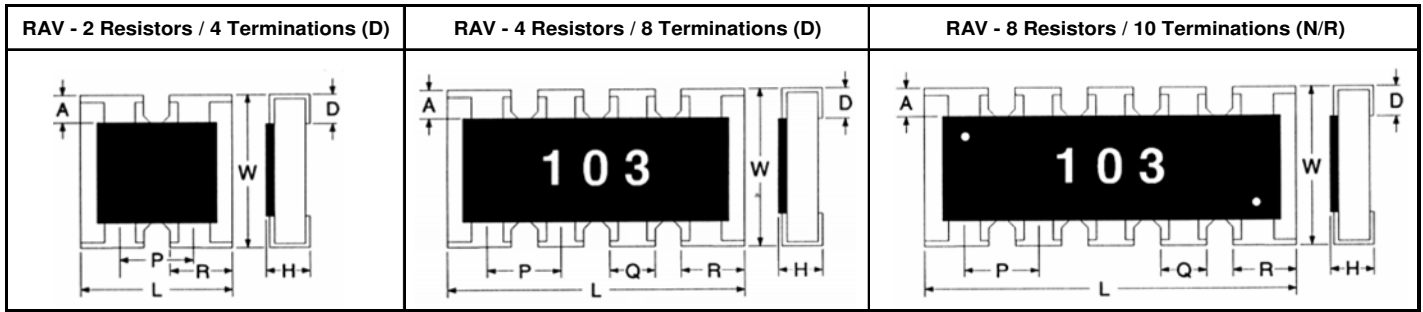

Mechanical Specifications

Type / Code / # of Elements / Circuit Type	L Body Length	W Body Width	H Body Height	P Element Spacing	Q Termination Width	R Termination Width	D Bottom Termination	A Top Termination	Inches mm
RAV 102D	0.039 ± 0.004 1 ± 0.1	0.039 ± 0.004 1 ± 0.1	0.014 ± 0.004 0.35 ± 0.1	0.026 ± 0.002 0.65 ± 0.05	-	0.013 ± 0.002 0.33 ± 0.05	0.01 ± 0.002 0.25 ± 0.05	0.006 ± 0.004 0.15 ± 0.1	Inches mm
RAV 104D	0.079 ± 0.008 2 ± 0.2	0.039 ± 0.006 1 ± 0.15	0.014 ± 0.006 0.35 ± 0.15	0.02 ± 0.006 0.5 ± 0.15	0.016 ± 0.008 0.4 ± 0.2	0.016 ± 0.006 0.4 ± 0.15	0.01 ± 0.004 0.25 ± 0.1	0.008 ± 0.004 0.2 ± 0.1	Inches mm
RAV 162D	0.063 ± 0.006 1.6 ± 0.15	0.063 ± 0.006 1.6 ± 0.15	0.02 ± 0.006 0.5 ± 0.15	0.031 ± 0.002 0.8 ± 0.05	-	0.024 ± 0.006 0.6 ± 0.15	0.012 ± 0.006 0.3 ± 0.15	0.012 ± 0.006 0.3 ± 0.15	Inches mm
RAV 164D	0.126 ± 0.004 3.2 ± 0.1	0.063 ± 0.004 1.6 ± 0.1	0.02 ± 0.004 0.5 ± 0.1	0.031 ± 0.002 0.8 ± 0.05	0.02 ± 0.004 0.5 ± 0.1	0.02 ± 0.004 0.5 ± 0.1	0.012 ± 0.006 0.3 ± 0.15	0.012 ± 0.008 0.3 ± 0.2	Inches mm
RAV 168D	0.158 ± 0.008 4.0 ± 0.2	0.063 ± 0.006 1.6 ± 0.15	0.016 ± 0.004 0.4 ± 0.1	0.02 ± 0.006 0.5 ± 0.15	0.012 ± 0.004 0.3 ± 0.1	0.016 ± 0.004 0.4 ± 0.1	0.012 ± 0.008 0.3 ± 0.2	0.012 ± 0.008 0.3 ± 0.2	Inches mm
RAV 324D	0.2 ± 0.008 5.08 ± 0.2	0.122 ± 0.008 3.1 ± 0.2	0.022 ± 0.004 0.55 ± 0.1	0.5 ± 0.004 1.27 ± 0.1	0.031 ± 0.008 0.8 ± 0.2	-	0.012 ± 0.008 0.3 ± 0.2	0.02 ± 0.008 0.5 ± 0.2	Inches mm
RAV 328N	0.126 ± 0.006 3.2 ± 0.15	0.063 ± 0.006 1.6 ± 0.15	0.02 ± 0.004 0.55 ± 0.1	0.025 ± 0.002 0.64 ± 0.05	0.013 ± 0.006 0.34 ± 0.15	0.019 ± 0.006 0.49 ± 0.15	0.01 ± 0.006 0.25 ± 0.15	0.012 ± 0.008 0.3 ± 0.2	Inches mm
RAV 328R	0.126 ± 0.006 3.2 ± 0.15	0.063 ± 0.006 1.6 ± 0.15	0.02 ± 0.004 0.55 ± 0.1	0.25 ± 0.002 0.64 ± 0.05	0.013 ± 0.006 0.34 ± 0.15	0.019 ± 0.006 0.49 ± 0.15	0.01 ± 0.006 0.25 ± 0.15	0.012 ± 0.008 0.3 ± 0.2	Inches mm

Performance Characteristics

Test	Test Results (JIS C 5202)
Load Life in Moisture	±3%
Temperature cycle	±1%
Load Life	±3%
Resistance to Soldering heat	±1%
Terminal Adhesion	±1%
Short Time Overload	±2%

Power Derating Curve:

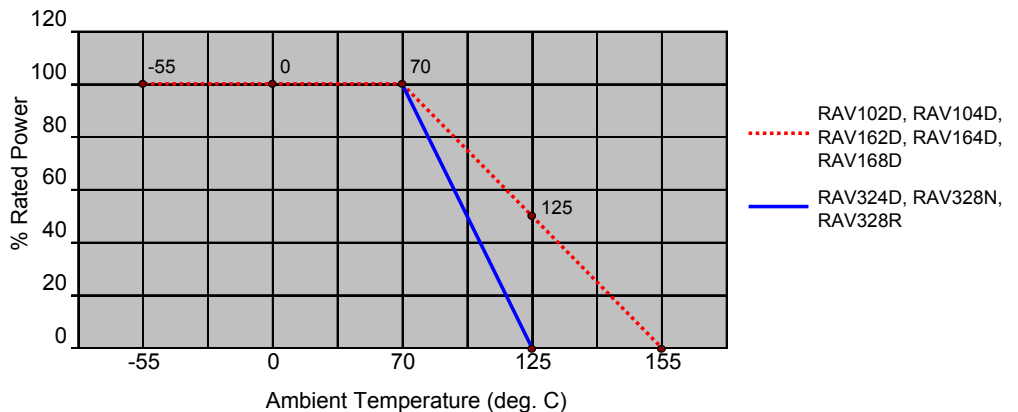

RAC Series

Concave Termination Chip Resistor Array

Stackpole Electronics, Inc.

Resistive Product Solutions

- Features:
- ✓ Thick film resistor element
 - ✓ Zero ohm available
 - ✓ Auto-placement capability
 - ✓ Multiple circuit types available
 - ✓ Ideal SMD substitute for leaded networks
 - ✓ RoHS compliant / lead-free available (RACF)

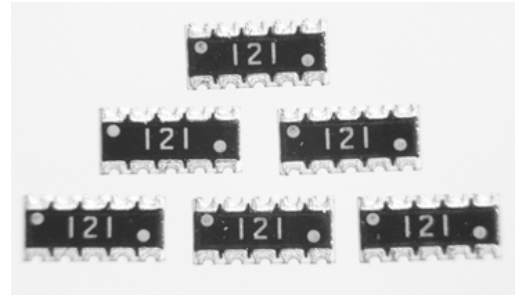

Electrical Specifications							
Type / Code / # of Elements / Circuit Type	Power Rating (per element) @ 70°C	Maximum Working Voltage [Ⓞ]	Maximum Overload Voltage	Resistance Temperature Coefficient	Ohmic Range and Tolerance		
					1%	2%	5%
RAC 16-4D	0.063W	50V	100V	±200 ppm/°C	1Ω - 1MΩ	1Ω - 10MΩ	1Ω - 10MΩ
RAC 32-4D	0.125W	200V	400V	±200 ppm/°C	22Ω - 1MΩ	-	10Ω - 1MΩ
RAC 40-8M	0.063W	25V	50V	±200 ppm/°C	-	-	22Ω - 1MΩ
RAC 64-8N	0.063W	50V	100V	±200 ppm/°C	-	-	22Ω - 1MΩ
RAC 64-8R	0.063W	50V	100V	±200 ppm/°C	-	-	22Ω - 1MΩ

Ⓞ Lesser of $\sqrt{\text{PR}}$ or maximum working voltage.

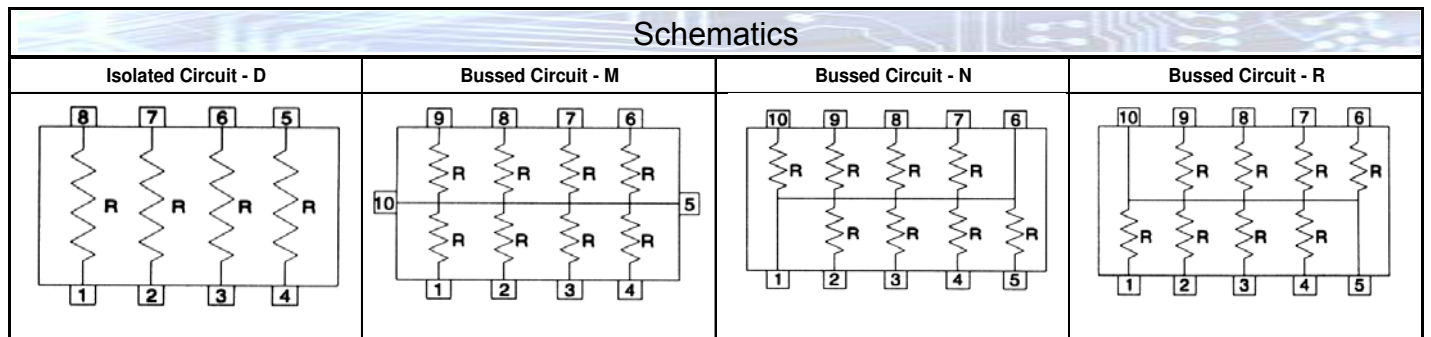

How to Order

SEI Type	Code	Number of Elements	Circuit Type	Nominal Resistance	Tolerance	Packaging				
RAC	16	4	D	10K	5%	R				
Type	Description	Code	Elements	Circuit Type	Tolerance	Values	SEI Types	Pkg Qty	Description	Code
RAC	Standard	16	4	D = Isolated	1%	E24	16	5,000	Paper	R
RACF	RoHS	32	8	M = Bussed	2%	E24	32, 40, 64	4,000	Emboss	R
		40		N = Bussed	5%	E24				
		64		R = Bussed						

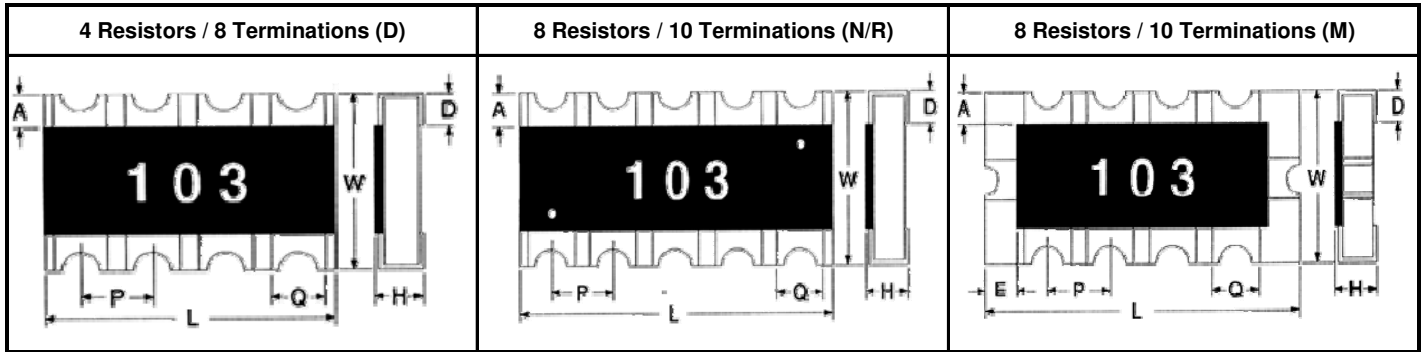

Mechanical Specifications

Type / Code / # of Elements / Circuit Type	L Body Length	W Body Width	H Body Height	P Element Spacing	Q Termination Width	D Bottom Termination	A Top Termination	E End Termination	Units
RAC 16-4D	0.126 ± 0.008 3.20 ± 0.20	0.063 ± 0.006 1.60 ± 0.15	0.024 ± 0.006 0.60 ± 0.15	0.031 0.80	0.016 ± 0.008 0.40 ± 0.2	0.016 ± 0.008 0.40 ± 0.20	0.012 ± 0.008 0.30 ± 0.20	-	inches mm
RAC 32-4D	0.200 ± 0.008 5.08 ± 0.20	0.118 ± 0.008 3.00 ± 0.20	0.024 ± 0.004 0.60 ± 0.10	0.050 1.27	0.031 ± 0.004 0.80 ± 0.10	0.020 ± 0.008 0.50 ± 0.20	0.022 ± 0.008 0.55 ± 0.20	-	inches mm
RAC 40-8M	0.157 ± 0.008 4.00 ± 0.20	0.083 ± 0.008 2.10 ± 0.20	0.024 ± 0.004 0.60 ± 0.10	0.031 0.80	0.020 ± 0.008 0.50 ± 0.20	0.016 ± 0.008 0.40 ± 0.20	0.010 ± 0.008 0.25 ± 0.20	0.012 ± 0.008 0.30 ± 0.20	inches mm
RAC 64-8N	0.252 ± 0.008 6.40 ± 0.20	0.122 ± 0.008 3.10 ± 0.20	0.024 ± 0.004 0.60 ± 0.10	0.050 1.27	0.028 ± 0.008 0.70 ± 0.20	0.020 ± 0.008 0.50 ± 0.20	0.014 ± 0.006 0.35 ± 0.15	-	inches mm
RAC 64-8R	0.252 ± 0.008 6.40 ± 0.20	0.122 ± 0.008 3.10 ± 0.20	0.024 ± 0.004 0.60 ± 0.10	0.050 1.27	0.028 ± 0.008 0.70 ± 0.20	0.020 ± 0.008 0.50 ± 0.20	0.014 ± 0.006 0.35 ± 0.15	-	inches mm

Performance Characteristics

Test	Test Results (JIS C 5202)
Load Life in Moisture	±3%
Temperature cycle	±1%
Load Life	±3%
Resistance to Soldering heat	±1%
Terminal Adhesion	±1%
Short Time Overload	±2%

Power Derating Curve

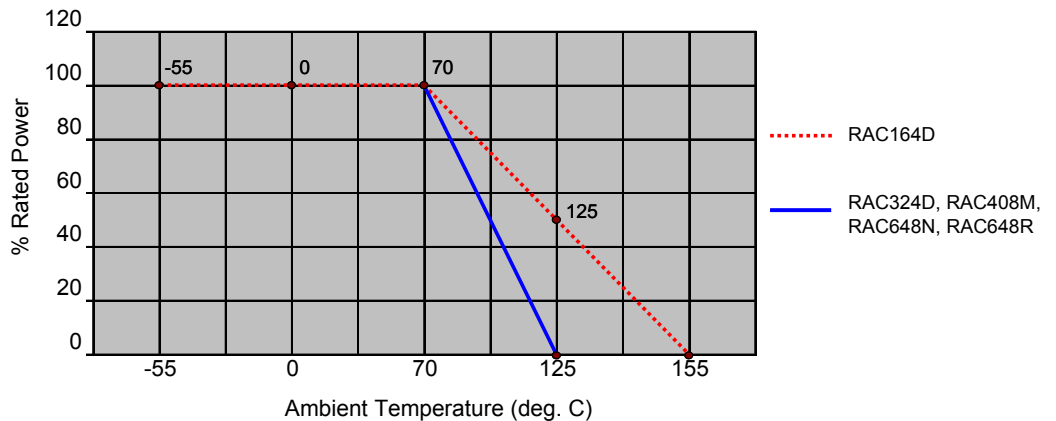

- Features:
- ✓ Ohmic values available up to 2,000G
 - ✓ Voltage ratings to 40,000 volts
 - ✓ Ultra-high stability
 - ✓ Tight tolerances to 0.1%
 - ✓ Low TCR to 10ppm/°C
 - ✓ Low VCR to 0.05ppm/volt
 - ✓ Very low noise
 - ✓ Custom solutions available

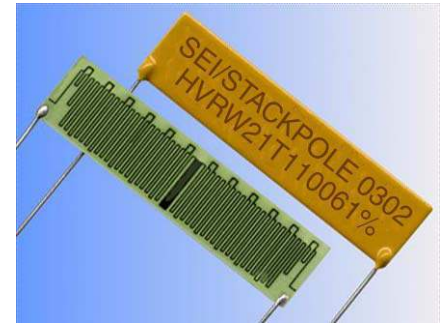

Electrical Specifications								
Case Size	Power Rating (Watts) @ 25°C	Maximum Voltage Rating (kv)	Resistance Temperature Coefficient	Ohmic Range and Tolerance				
				0.1%	0.25%, 0.5%	1%	2%	5%, 10%, 20%
39	0.5W	2KV	±25ppm/°C	<30M - 100M	<30M - 100M	<30M - 100M	<30M - 100M	<30M - 100M
			±50ppm/°C	-	>100M - 2G	>100M - 2G	>100M - 2G	>100M - 2G
			±100ppm/°C	-	-	>2G - 20G	>2G - 50G	>2G - 100G
29	0.5W	4KV	±25ppm/°C	<30M - 100M	<30M - 100M	<30M - 100M	<30M - 100M	<30M - 100M
			±50ppm/°C	-	>100M - 2G	>100M - 2G	>100M - 2G	>100M - 2G
			±100ppm/°C	-	-	>2G - 20G	>2G - 50G	>2G - 100G
21	1W	10KV	±25ppm/°C	<30M - 100M	<30M - 100M	<30M - 100M	<30M - 100M	<30M - 100M
			±50ppm/°C	-	>100M - 2G	>100M - 2G	>100M - 2G	>100M - 2G
			±100ppm/°C	-	-	>2G - 20G	>2G - 50G	>2G - 100G
42	2W	20KV	±25ppm/°C	<30M - 100M	<30M - 100M	<30M - 100M	<30M - 100M	<30M - 100M
			±50ppm/°C	-	>100M - 2G	>100M - 2G	>100M - 2G	>100M - 2G
			±100ppm/°C	-	-	>2G - 20G	>2G - 50G	>2G - 100G
43	3W	30KV	±25ppm/°C	<30M - 100M	<30M - 100M	<30M - 100M	<30M - 100M	<30M - 100M
			±50ppm/°C	-	>100M - 2G	>100M - 2G	>100M - 2G	>100M - 2G
			±100ppm/°C	-	-	>2G - 20G	>2G - 50G	>2G - 100G
56	6W	40KV	±25ppm/°C	<30M - 100M	<30M - 100M	<30M - 100M	<30M - 100M	<30M - 100M
			±50ppm/°C	-	>100M - 2G	>100M - 2G	>100M - 2G	>100M - 2G
			±100ppm/°C	-	-	>2G - 20G	>2G - 50G	>2G - 100G

How to Order

SEI Type	Lead Style	Case Size	TCR Rating ^①	Nominal Resistance	Tolerance ^②																									
HVR	W	42	T9	50M	1%																									
		<table border="1"> <thead> <tr><th>Case Size</th></tr> </thead> <tbody> <tr><td>39</td></tr> <tr><td>29</td></tr> <tr><td>21</td></tr> <tr><td>42</td></tr> <tr><td>43</td></tr> <tr><td>56</td></tr> </tbody> </table>	Case Size	39	29	21	42	43	56	<table border="1"> <thead> <tr><th>TCR Rating</th></tr> </thead> <tbody> <tr><td>T9</td><td>±25ppm/°C</td></tr> <tr><td>T2</td><td>±50ppm/°C</td></tr> <tr><td>T1</td><td>±100ppm/°C</td></tr> <tr><td>T0</td><td>±200ppm/°C</td></tr> </tbody> </table>	TCR Rating	T9	±25ppm/°C	T2	±50ppm/°C	T1	±100ppm/°C	T0	±200ppm/°C		<table border="1"> <thead> <tr><th>Ratio Tolerance</th></tr> </thead> <tbody> <tr><td>±0.1%</td></tr> <tr><td>±0.25%</td></tr> <tr><td>±0.5%</td></tr> <tr><td>±1%</td></tr> <tr><td>±2%</td></tr> <tr><td>±5%</td></tr> <tr><td>±10%</td></tr> <tr><td>±20%</td></tr> </tbody> </table>	Ratio Tolerance	±0.1%	±0.25%	±0.5%	±1%	±2%	±5%	±10%	±20%
Case Size																														
39																														
29																														
21																														
42																														
43																														
56																														
TCR Rating																														
T9	±25ppm/°C																													
T2	±50ppm/°C																													
T1	±100ppm/°C																													
T0	±200ppm/°C																													
Ratio Tolerance																														
±0.1%																														
±0.25%																														
±0.5%																														
±1%																														
±2%																														
±5%																														
±10%																														
±20%																														

Note ①: TCR is measured from 25°C to 75°C
 Note ②: Tolerance is dependent on case size and value

Low Noise Characteristic

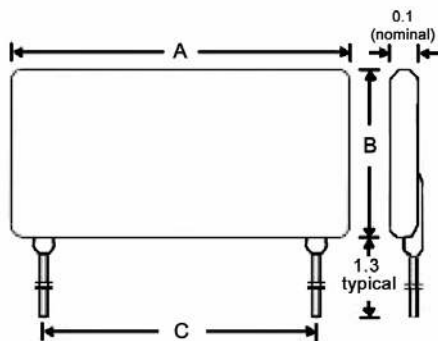
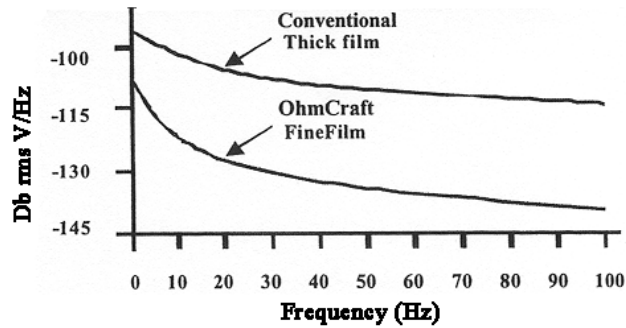

Mechanical Specifications				
HVR Case Size	A	B	C	Units
39	0.3 + 0.08/-0.03 7.62 + 2.032/-0.762	0.4 ± 0.03 10.16 ± 0.762	0.2 5.08	inches mm
29	0.5 + 0.08/-0.03 12.7 + 2.032/-0.762	0.375 ± 0.03 9.525 ± 0.762	0.4 10.16	inches mm
21	1 + 0.08/-0.03 25.4 + 2.032/-0.762	0.375 ± 0.03 9.525 ± 0.762	0.9 22.86	inches mm
42	2 + 0.08/-0.03 50.8 + 2.032/-0.762	0.5 ± 0.03 12.7 ± 0.762	1.9 48.26	inches mm
43	3 + 0.08/-0.03 76.2 + 2.032/-0.762	0.5 ± 0.03 12.7 ± 0.762	2.9 73.66	inches mm
56	4 + 0.08/-0.03 101.6 + 2.032/-0.762	0.75 ± 0.03 19.05 ± 0.762	3.9 99.06	inches mm

HVD Series

High Voltage Plate Resistor Divider

Stackpole Electronics, Inc.

Resistive Product Solutions

- Features:
- ✓ Ohmic values to 2,000G
 - ✓ Voltage ratings to 40,000 volts
 - ✓ Ultra-high stability
 - ✓ Tight tolerances to 0.1%
 - ✓ Very low noise
 - ✓ Low TCR to 10 ppm/°C
 - ✓ Low TCR tracking to 5 ppm/°C
 - ✓ Low VCR to 0.05 ppm/volt
 - ✓ Custom solutions available
 - ✓ RoHS compliant / lead-free

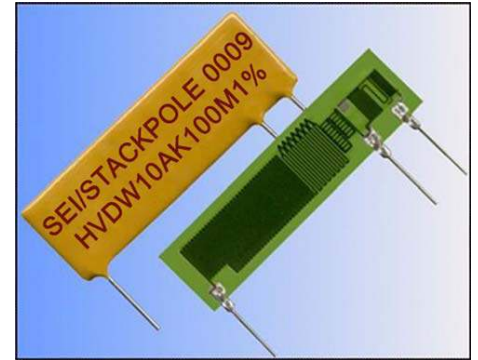

Utilizing fine film resistor deposition technology, SEI now offers a new level of stability and performance in leaded resistor dividers.

Competing product technologies have constraints due to their dependence on certain limiting composite materials. Traditional thick film products have restricted performance characteristics, while thin film offerings are confined within certain ohmic value ranges.

In addition to improving on these limitations, the fine film deposition demonstrates new characteristics, such as a longer high-aspect ratio trace of lower resistivity film.

These fine film resistor dividers provide unique design efficiency, versatility and linearity, through the combination of long line, high aspect ratio and higher conductivity film.

Electrical Specifications			
HVD Case Size	Power (watts) @ 25°C	Maximum Voltage Rating	Tolerance
04	0.5W	4KV	0.1% - 1%
05	1W	5KV	0.1% - 1%
10	1W	10KV	0.25% - 1%
20	2W	20KV	0.25% - 0.5%
30	3W	30KV	0.5% - 5%
40	6W	40KV	0.5% - 5%

How to Order

SEI Type	Lead Style	Case Size	Ratio	Absolute TCR ^①	Total R Value ^②	Ratio Tolerance																																													
HVD	W	04	A	E	2005	B																																													
	<table border="1"> <thead> <tr> <th colspan="2">Lead Style</th> </tr> </thead> <tbody> <tr> <td>S</td> <td>Spade</td> </tr> <tr> <td>W</td> <td>Wire</td> </tr> </tbody> </table>	Lead Style		S	Spade	W	Wire	<table border="1"> <thead> <tr> <th>Case Size</th> </tr> </thead> <tbody> <tr><td>04</td></tr> <tr><td>05</td></tr> <tr><td>10</td></tr> <tr><td>20</td></tr> <tr><td>30</td></tr> <tr><td>40</td></tr> </tbody> </table>	Case Size	04	05	10	20	30	40	<table border="1"> <thead> <tr> <th colspan="2">Ratio</th> </tr> </thead> <tbody> <tr> <td>A</td> <td>1,000:1</td> </tr> <tr> <td>B</td> <td>100:1</td> </tr> <tr> <td>C</td> <td>Other</td> </tr> </tbody> </table>	Ratio		A	1,000:1	B	100:1	C	Other	<table border="1"> <thead> <tr> <th colspan="2">Absolute TCR</th> </tr> </thead> <tbody> <tr> <td>E</td> <td>±25ppm/°C</td> </tr> <tr> <td>H</td> <td>±50ppm/°C</td> </tr> <tr> <td>K</td> <td>±100ppm/°C</td> </tr> <tr> <td>L</td> <td>±200ppm/°C</td> </tr> </tbody> </table>	Absolute TCR		E	±25ppm/°C	H	±50ppm/°C	K	±100ppm/°C	L	±200ppm/°C		<table border="1"> <thead> <tr> <th colspan="2">Ratio Tolerance</th> </tr> </thead> <tbody> <tr> <td>B</td> <td>±0.1%</td> </tr> <tr> <td>C</td> <td>±0.25%</td> </tr> <tr> <td>D</td> <td>±0.5%</td> </tr> <tr> <td>F</td> <td>±1%</td> </tr> <tr> <td>G</td> <td>±2%</td> </tr> <tr> <td>J</td> <td>±5%</td> </tr> </tbody> </table>	Ratio Tolerance		B	±0.1%	C	±0.25%	D	±0.5%	F	±1%	G	±2%	J	±5%
Lead Style																																																			
S	Spade																																																		
W	Wire																																																		
Case Size																																																			
04																																																			
05																																																			
10																																																			
20																																																			
30																																																			
40																																																			
Ratio																																																			
A	1,000:1																																																		
B	100:1																																																		
C	Other																																																		
Absolute TCR																																																			
E	±25ppm/°C																																																		
H	±50ppm/°C																																																		
K	±100ppm/°C																																																		
L	±200ppm/°C																																																		
Ratio Tolerance																																																			
B	±0.1%																																																		
C	±0.25%																																																		
D	±0.5%																																																		
F	±1%																																																		
G	±2%																																																		
J	±5%																																																		

Note ①: TCR tracking typically < 25% of the absolute TCR to a minimum of 10ppm/°C

Note ②: Express value as a four digit number, the first three numbers are the significant value and the fourth number is the number of zeros

Design Flexibility:

The HVD series can accommodate virtually any divider ratio due to the long serpentine pattern in the fine film manufacturing, combined with the utilization of low ohms/square thick film inks. Please contact SEI with custom design needs.

Divider Design

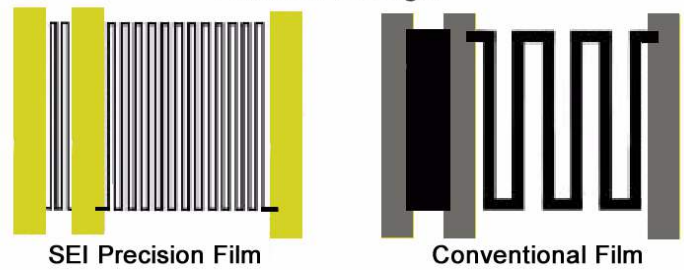

Excellent VCR Tracking:

The VCR is virtually flat over a wide range of values.

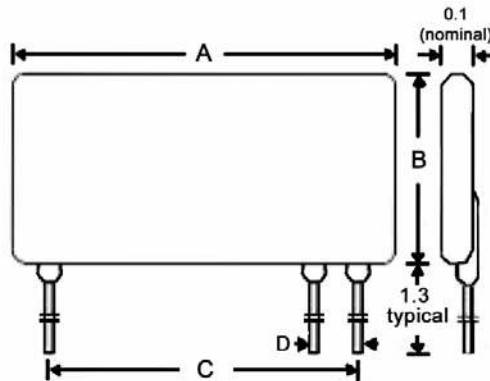
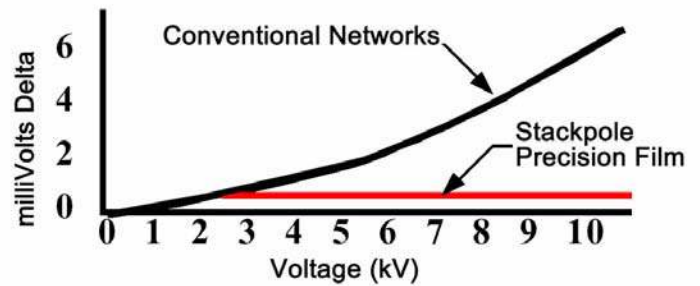

Mechanical Specifications					
Case Size	A	B	C	D	Units
04	0.5 +0.08/-0.03 12.7 + 2.032/-0.762	0.375 ± 0.03 9.525 ± 0.762	0.4 10.16	0.2 5.08	inches mm
05	1 + 0.08/-0.03 25.4 + 2.032/-0.762	0.375 ± 0.03 9.525 ± 0.762	0.9 22.86	0.2 5.08	inches mm
10	1.5 + 0.08/-0.03 38.1 + 2.032/-0.762	0.5 ± 0.03 12.7 ± 0.762	1.3 33.02	0.2 5.08	inches mm
20	2 + 0.08/-0.03 50.8 + 2.032/-0.762	0.75 ± 0.03 19.05 ± 0.762	1.9 48.26	0.2 5.08	inches mm
30	3 + 0.08/-0.03 76.2 + 2.032/-0.762	0.75 ± 0.03 19.05 ± 0.762	2.9 73.66	0.2 5.08	inches mm
40	4 + 0.08/-0.03 101.6 + 2.032/-0.762	0.75 ± 0.03 19.05 ± 0.762	3.9 99.06	0.2 5.08	inches mm

- Features:
- ✓ 0402 to 2512 & 1225 sizes available
 - ✓ Power ratings to 3W
 - ✓ Low inductance – less than 0.2nH typically
 - ✓ RoHS compliant
 - ✓ Non-standard resistance values available
 - ✓ 2010 and 2512 sizes available with narrow terminations (CSRN)



Electrical Specifications						
Type / Code	Package Type	Power Rating (Watts) @ 70°C	Dielectric Withstanding Voltage	Resistance Temperature Coefficient	Ohmic Range and Tolerance	
					1%	2%, 5%
CSR 1/8S	0402	0.125W	200V	±200 ppm/°C	0.051Ω - 1Ω	0.051Ω - 1Ω
CSR 1/8	0603	0.125W	200V	±300 ppm/°C	0.021Ω - 1Ω	0.021Ω - 1Ω
CSR 1/4	0805	0.250W	200V	±200 ppm/°C	0.01Ω - 1Ω	0.021Ω - 1Ω
CSR 1/2	1206	0.500W	200V	±100 ppm/°C *	0.01Ω - 1Ω	0.01Ω - 1Ω
CSRN 1S	0815	1.000W	200V	±300 ppm/°C ±150 ppm/°C	0.01Ω - 0.019Ω 0.02Ω - 0.5Ω	0.01Ω - 0.019Ω 0.02Ω - 0.5Ω
CSR 1	2010	1.000W	200V	±100 ppm/°C *	0.01Ω - 1Ω	0.01Ω - 1Ω
CSRN 1S	2010	1.000W	200V	±250 ppm/°C	0.01Ω - 1Ω	0.01Ω - 1Ω
CSR 2	2512	2.000W	200V	±200 ppm/°C	0.01Ω - 1Ω	0.01Ω - 1Ω
CSRN 2	2512	2.000W	200V	±200 ppm/°C	0.01Ω - 1Ω	0.01Ω - 1Ω
CSR 3	1225	3.000W	200V	±200 ppm/°C ±100 ppm/°C	0.003Ω - 0.02Ω 0.021Ω - 10Ω	0.003Ω - 0.02Ω 0.021Ω - 10Ω

Performance Characteristics		
Test	Test Specification	Typical
Moisture Resistance	± 0.5%	≤ 0.5%
Load Life	± 0.5%	≤ 0.5%
Leach Resistance	90 seconds minimum	> 90 seconds
Resistance to Soldering Heat	± 0.5%	≤ 0.25%
Solderability	minimum 95% coverage	≥ 95%
Temperature Cycling	± 0.5%	≤ 0.5%
Thermal Shock	± 0.5%	≤ 0.5%
Short Time Overload	± 0.5%	≤ 0.5%
Insulation Resistance	1MΩ minimum	≥ 1MΩ

Operating Temperature Range: -55°C to +155°C

How to Order

SEI Type		Code			Nominal Resistance	Tolerance	Packaging			
CSR		1/2			0.01	1%	R			
Type	Description	Code	Wattage	Size	Tolerance		SEI Types	Pkg Qty	Description	Code
CSR	Standard	1/8S	0.125W	0402	1%		1/8S	10,000	7" reel	R
CSF	Standard RoHS	1/8	0.125W	0603	2%		1/8, 1/4, 1/2	5,000		
CSRN	Narrow Terminations	1/4	0.250W	0805	5%		1, 2	4,000		
CSFN	Narrow Terminations RoHS	1/2	0.500W	1206			1S, 3	2,000		
		1S	1.000W	0815						
		1	1.000W	2010						
		2	2.000W	2512						
		3	3.000W	1225						

Mechanical Specifications						
Type / Code	L Body Length	W Body Width	H Body Height	a Top Termination	b Bottom Termination	Units
CSR 1/8 S	0.039 ± 0.002	0.020 ± 0.002	0.013 ± 0.004	0.010 ± 0.004	0.008 ± 0.004	inches
	1.000 ± 0.050	0.500 ± 0.050	0.320 ± 0.100	0.250 ± 0.100	0.200 ± 0.100	mm
CSR 1/8	0.063 ± 0.004	0.032 ± 0.004	0.018 ± 0.004	0.012 ± 0.008	0.012 ± 0.008	inches
	1.600 ± 0.100	0.800 ± 0.100	0.450 ± 0.100	0.300 ± 0.200	0.300 ± 0.200	mm
CSR 1/4	0.079 ± 0.006	0.049 ± 0.006	0.022 ± 0.004	0.012 ± 0.008	0.016 ± 0.010	inches
	2.000 ± 0.150	1.250 ± 0.150	0.550 ± 0.100	0.300 ± 0.200	0.400 ± 0.250	mm
CSR 1/2	0.120 ± 0.006	0.061 ± 0.006	0.022 ± 0.004	0.020 ± 0.012	0.016 ± 0.010	inches
	3.050 ± 0.150	1.550 ± 0.150	0.550 ± 0.100	0.500 ± 0.300	0.400 ± 0.250	mm
CSRN 1S	0.079 ± 0.008	0.148 ± 0.008	0.024 ± 0.004	0.016 ± 0.008	0.016 ± 0.008	inches
	2.000 ± 0.200	3.750 ± 0.200	0.600 ± 0.100	0.400 ± 0.200	0.400 ± 0.200	mm
CSR 1	0.197 ± 0.008	0.100 ± 0.008	0.020 ± 0.006	0.068 ± 0.006	0.067 ± 0.006	inches
	5.003 ± 0.200	2.540 ± 0.200	0.508 ± 0.150	1.720 ± 0.150	1.702 ± 0.150	mm
CSRN 1	0.197 ± 0.008	0.097 ± 0.006	0.024 ± 0.006	0.024 ± 0.012	0.020 ± 0.010	inches
	5.000 ± 0.200	2.450 ± 0.150	0.600 ± 0.150	0.600 ± 0.300	0.508 ± 0.250	mm
CSR 2	0.252 ± 0.008	0.126 ± 0.008	0.020 ± 0.006	0.075 ± 0.006	0.075 ± 0.006	inches
	6.401 ± 0.200	3.200 ± 0.200	0.508 ± 0.150	1.905 ± 0.150	1.905 ± 0.150	mm
CSRN 2 (10-99 milliohm)	0.250 ± 0.008	0.124 ± 0.006	0.029 ± 0.004	0.024 ± 0.012	0.022 ± 0.010	inches
	6.350 ± 0.200	3.150 ± 0.150	0.740 ± 0.100	0.600 ± 0.300	0.550 ± 0.250	mm
CSRN 2 (100-1000 milliohm)	0.250 ± 0.008	0.124 ± 0.006	0.029 ± 0.004	0.024 ± 0.012	0.107 ± 0.004	inches
	6.350 ± 0.200	3.150 ± 0.150	0.740 ± 0.100	0.600 ± 0.300	2.700 ± 0.100	mm
CSR 3	0.122 ± 0.006	0.248 ± 0.006	0.035 ± 0.006	0.024 ± 0.012	0.022 ± 0.010	inches
	3.100 ± 0.150	6.300 ± 0.150	0.900 ± 0.150	0.600 ± 0.300	0.550 ± 0.250	mm

Solder Pad Dimensions

Type / Code	L Total Length	W Total Width	D Pad Depth	Units
CSR 1/8 S	0.05	0.03	0.02	inches
	1.30	0.80	0.40	mm
CSR 1/8	0.08	0.04	0.03	inches
	2.10	1.10	0.70	mm
CSR 1/4	0.11	0.06	0.04	inches
	2.70	1.40	1.00	mm
CSR 1/2	0.16	0.07	0.06	inches
	4.00	1.80	1.40	mm
CSRN 1S	0.15	0.18	0.06	inches
	3.80	4.50	1.50	mm
CSR 1	0.25	0.11	0.07	inches
	6.40	2.70	1.80	mm
CSRN 1	0.25	0.14	0.06	inches
	6.40	3.60	1.40	mm
CSR 2	0.31	0.15	0.10	inches
	8.00	3.75	2.50	mm
CSRN 2	0.31	0.15	0.10	inches
	8.00	3.75	2.50	mm
CSR 3	0.20	0.30	0.08	inches
	5.08	7.60	2.00	mm

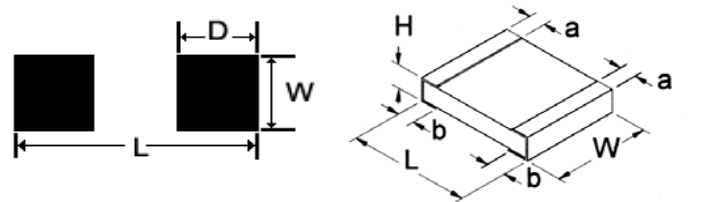

CSR3 (1225) 4 Terminal Bottom

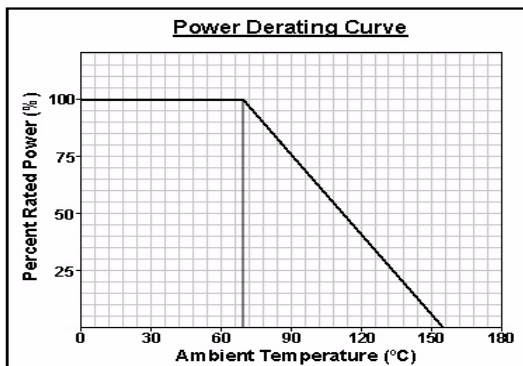
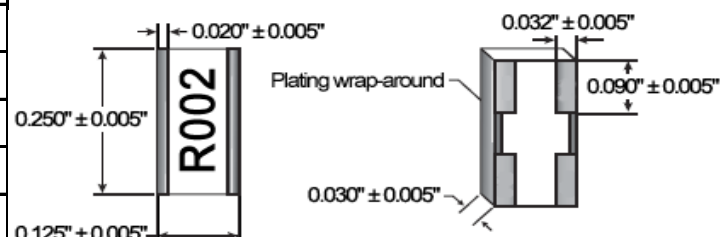

- Features:
- ✓ High power metal alloy current sense resistor
 - ✓ Very low inductance (0.5nH to 5nH)
 - ✓ High temperature performance: up to 275°C
 - ✓ Excellent frequency response
 - ✓ Low thermal EMF (<1μV/C)
 - ✓ Proprietary processing technique produces extremely low resistance values
 - ✓ RoHS compliant / lead-free



Electrical Specifications					
Type / Code	Package Type	Power Rating (Watts) @ 100°C	Resistance Temperature Coefficient	Ohmic Range and Tolerance	
				0.5%	1%, 5%
CSS 1206	1206	0.5W	±50 ppm/°C ±25 ppm/°C ±15 ppm/°C	- 0.007Ω - 0.05Ω -	0.002Ω - 0.004Ω 0.005Ω - 0.015Ω 0.016Ω - 0.05Ω
CSS 2010	2010	1W	±50 ppm/°C ±25 ppm/°C ±15 ppm/°C	- 0.003Ω - 0.0069Ω 0.007Ω - 0.1Ω	0.0005Ω - 0.003Ω 0.004Ω - 0.0069Ω 0.007Ω - 0.1Ω
CSS 2512	2512	2W	±50 ppm/°C ±25 ppm/°C ±15 ppm/°C	- - 0.007Ω - 0.075Ω	0.0005Ω - 0.003Ω 0.004Ω - 0.0069Ω 0.007Ω - 0.075Ω
CSSH 2512	2512	3W	±50 ppm/°C ±25 ppm/°C	0.007Ω - 0.01Ω	0.0005Ω - 0.01Ω
CSS 2725	2725	4W	±50 ppm/°C ±25 ppm/°C	- -	0.00025Ω - 0.0009Ω 0.001Ω - 0.003Ω
CSS 2728	2728	3W	±25 ppm/°C ±15 ppm/°C	0.004Ω - 0.007Ω 0.008Ω - 0.1Ω	0.004Ω - 0.007Ω 0.008Ω - 0.1Ω
CSSH 2728	2728	4W	±25 ppm/°C ±15 ppm/°C	0.004Ω - 0.007Ω 0.008Ω - 0.05Ω	0.004Ω - 0.007Ω 0.008Ω - 0.05Ω

How to Order

SEI Type		Code			Nominal Resistance	Tolerance	Packaging			
CSS		2725			0.003	1%	R			
Type	Description	Code	Wattage	Size	Tolerance		SEI Types	Quantity		Description
CSS	Metal Alloy	1206	0.5W	1206	0.5%	7" - Embossed Plastic	CSS 1206	2,000	R	
CSSH	High Power	2010	1W	2010	1%		CSS 2010			
		2512	2W	2512	5%		CSS 2512	1,000	R	
		(H) 2512	3W	2512			CSSH 2512			
		2725	4W	2725			CSS 2725			
		(H) 2728	4W	2728			CSS 2728			
						CSSH 2728				

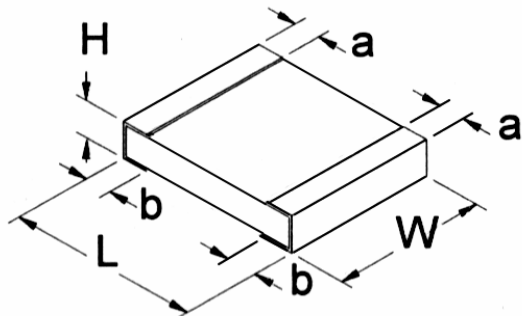

Power Derating Curve

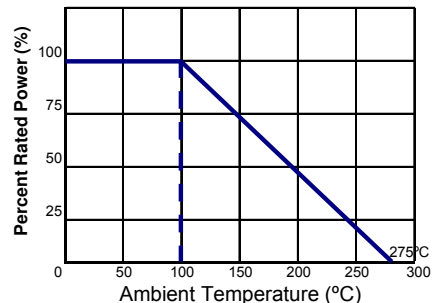

Mechanical Specifications

Type / Code	L Body Length	W Body Width	H Body Height	a Top Termination	b Bottom Termination	Units
CSS 1206	3.15 ± 0.254	1.60 ± 0.254	0.750 ± 0.254	0.50 ± 0.254	0.50 ± 0.254	mm
CSS 2010 (≤3mΩ)	5.10 ± 0.254	2.54 ± 0.254	0.800 ± 0.254	0.80 ± 0.254	0.80 ± 0.254	mm
CSS 2512 (≤4mΩ)	6.25 ± 0.254	3.30 ± 0.254	0.800 ± 0.254	1.88 ± 0.254	1.88 ± 0.254	mm
CSS 2512 (≥5mΩ)	6.25 ± 0.254	3.30 ± 0.254	0.800 ± 0.254	1.13 ± 0.254	1.13 ± 0.254	mm
CSSH 2512 (≤1.5mΩ)	6.25 ± 0.254	3.30 ± 0.254	0.800 ± 0.254	1.88 ± 0.254	1.88 ± 0.254	mm
CSSH 2512 (≥2mΩ)	6.25 ± 0.254	3.30 ± 0.254	0.800 ± 0.254	1.13 ± 0.254	1.13 ± 0.254	mm
CSS 2725 (0.25mΩ)	6.80 ± 0.254	6.70 ± 0.254	1.000 ± 0.254	2.15 ± 0.254	2.15 ± 0.254	mm
CSS 2725 (1mΩ)	6.80 ± 0.254	6.70 ± 0.254	1.010 ± 0.254	2.15 ± 0.254	2.15 ± 0.254	mm
CSS 2725 (1.5mΩ)	6.80 ± 0.254	6.70 ± 0.254	1.000 ± 0.254	2.15 ± 0.254	2.15 ± 0.254	mm
CSS 2725 (2mΩ)	6.80 ± 0.254	6.70 ± 0.254	0.900 ± 0.254	1.80 ± 0.254	1.80 ± 0.254	mm
CSS 2725 (2.5mΩ)	6.80 ± 0.254	6.70 ± 0.254	0.900 ± 0.254	1.65 ± 0.254	1.65 ± 0.254	mm
CSS 2725 (3mΩ)	6.80 ± 0.254	6.70 ± 0.254	0.900 ± 0.254	1.30 ± 0.254	1.30 ± 0.254	mm
CSS 2728	7.20 ± 0.254	6.70 ± 0.254	1.000 ± 0.254	1.15 ± 0.254	1.15 ± 0.254	mm
CSSH 2728	7.20 ± 0.254	6.70 ± 0.254	1.000 ± 0.254	1.15 ± 0.254	1.15 ± 0.254	mm

Performance Characteristics

Test	Test Method	Test Specification	Typical
Load Life	MIL-STD-502F-Method 108A RCWV at 70°C; 1.5hrs ON; 0.5hrs OFF Total 1024 ± 24hrs	± 0.5%	≤ 0.5%
Resistance to Soldering Heat	MIL-STD-202F-Method 210E 260 ± 5°C for 10 ± 1sec	± 0.5%	≤ 0.25%
Solderability	MIL-STD-202F-Method 208H 245 ± 5°C for 2 ± 0.5sec	minimum 95% coverage	> 95%
Thermal Shock	MIL-STD-202F-Method 107G -55°C to 150°C, 100 cycles	± 0.5%	≤ 0.5%
Short Time Overload	JIS-C-5202-5.5 5x rated power for 5 sec	± 0.5%	≤ 0.5%
Temperature Cycling	JIS-C-5202-7.4 -55°C: 30 min. 25°C: 2 to 3 min. 155°C: 30min. 25°C: 2 to 3 min.	± 0.5%	≤ 0.5%
Moisture Resistance	MIL-STD-202F-Method 106G	± 0.5%	≤ 0.5%
Insulation Resistance	MIL-STD-202F-Method 302 Apply 100Vdc for 1 minute	1MΩ minimum	≥ 1MΩ
Leach Resistance	-	90 seconds minimum	≥ 90 seconds

Operating Temperature Range: -65°C to +275°C

- Features:
- ✓ High power current sense resistor
 - ✓ TCR of ± 50 ppm/ $^{\circ}$ C
 - ✓ Resistances down to 0.0005 (1/2 m Ω)
 - ✓ Current handling up to 63 amps
 - ✓ Non-standard resistance values available
 - ✓ RoHS compliant / lead-free



Electrical Specifications					
Type / Code	Package Type	Power Rating (Watts) @ 70 $^{\circ}$ C	Dielectric Withstanding Voltage	Resistance Temperature Coefficient	Ohmic Range and Tolerance
					1%, 5%
CSNL 1/2	1206	1W	200V	± 50 ppm/ $^{\circ}$ C	0.001 Ω - 0.05 Ω
CSNL 1	2010	1.5W	200V	± 50 ppm/ $^{\circ}$ C	0.0005 Ω - 0.1 Ω
CSNL 2	2512	2W	200V	± 50 ppm/ $^{\circ}$ C	0.0005 Ω - 0.01 Ω
CSNL 3	2512	3W	200V	± 50 ppm/ $^{\circ}$ C	0.001 - 0.003
				± 100 ppm/ $^{\circ}$ C	0.0005 - 0.00075

Performance Characteristics			
Test	Test Method	Test Specification	Typical
Load Life	MIL-STD-502F-Method 108A RCWV at 70 $^{\circ}$ C; 1.5hrs ON; 0.5hrs OFF Total 1024 \pm 24hrs	$\pm 0.5\%$	$\leq 0.5\%$
Resistance to Soldering Heat	MIL-STD-202F-Method 210E 260 \pm 5 $^{\circ}$ C for 10 \pm 1sec	$\pm 0.5\%$	$\leq 0.25\%$
Solderability	MIL-STD-202F-Method 208H 245 \pm 5 $^{\circ}$ C for 2 \pm 0.5sec	minimum 95% coverage	> 95%
Thermal Shock	MIL-STD-202F-Method 107G -55 $^{\circ}$ C to 150 $^{\circ}$ C, 100 cycles	$\pm 0.5\%$	$\leq 0.5\%$
Short Time Overload	JIS-C-5202-5.5 5x rated power for 5 sec	$\pm 0.5\%$	$\leq 0.5\%$
Temperature Cycling	JIS-C-5202-7.4 -55 $^{\circ}$ C: 30 min. 25 $^{\circ}$ C: 2 to 3 min. 155 $^{\circ}$ C: 30min. 25 $^{\circ}$ C: 2 to 3 min.	$\pm 0.5\%$	$\leq 0.5\%$
Moisture Resistance	MIL-STD-202F-Method 106G	$\pm 0.5\%$	$\leq 0.5\%$
Insulation Resistance	MIL-STD-202F-Method 302 Apply 100Vdc for 1 minute	1M Ω minimum	$\geq 1M\Omega$
Leach Resistance	-	90 seconds minimum	≥ 90 seconds

Operating Temperature Range: -55 $^{\circ}$ C to +170 $^{\circ}$ C

How to Order

SEI Type		Code			Nominal Resistance	Tolerance	Packaging			
CSNL		1/2			0.01	1%	R			
Type	Description	Code	Wattage	Size	Tolerance		SEI Types	Pkg Qty	Description	Code
CSNL	Metal Foil	1/2	1W	1206	1%		ALL	2,000	7" reel	R
		1	1.5W	2010	5%					
		2	2W	2512						
		3	3W	2512						

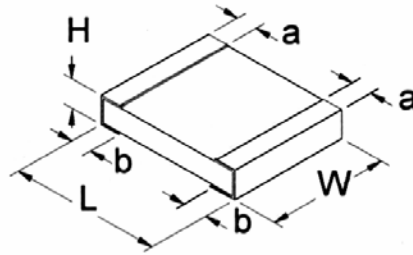

Mechanical Specifications

Type / Code	L Body Length	W Body Width	H Body Height	a Top Termination	b Bottom Termination	Units
CSNL 1/2	3.30 ± 0.254	1.80 ± 0.254	0.750 ± 0.254	0.50 ± 0.254	0.50 ± 0.254	mm
CSNL 1 (≤3mΩ)	5.10 ± 0.254	2.54 ± 0.254	0.80 ± 0.254	1.60 ± 0.254	1.60 ± 0.254	mm
CSNL 1 (≥4mΩ)	5.10 ± 0.254	2.54 ± 0.254	0.80 ± 0.254	0.80 ± 0.254	0.80 ± 0.254	mm
CSNL 2 (0.5mΩ)	6.35 ± 0.25	3.18 ± 0.25	1.40 ± 0.20	1.425 ± 0.377	1.425 ± 0.377	mm
CSNL 2 (0.75mΩ)	6.35 ± 0.25	3.18 ± 0.25	1.00 ± 0.20	1.425 ± 0.377	1.425 ± 0.377	mm
CSNL 2 (1.0mΩ)	6.35 ± 0.25	3.18 ± 0.25	0.80 ± 0.20	1.425 ± 0.377	1.425 ± 0.377	mm
CSNL 2 (1.5mΩ)	6.35 ± 0.25	3.18 ± 0.25	0.65 ± 0.20	1.425 ± 0.377	1.425 ± 0.377	mm
CSNL 2 (2.0mΩ)	6.35 ± 0.25	3.18 ± 0.25	0.50 ± 0.20	1.425 ± 0.377	1.425 ± 0.377	mm
CSNL 2 (2.5mΩ)	6.35 ± 0.25	3.18 ± 0.25	1.00 ± 0.20	1.425 ± 0.377	1.425 ± 0.377	mm
CSNL 2 (3mΩ)	6.35 ± 0.25	3.18 ± 0.25	0.70 ± 0.20	1.425 ± 0.377	1.425 ± 0.377	mm
CSNL 2 (3.5mΩ)	6.35 ± 0.25	3.18 ± 0.25	0.71 ± 0.20	1.425 ± 0.377	1.425 ± 0.377	mm
CSNL 2 (4mΩ)	6.35 ± 0.25	3.18 ± 0.25	0.60 ± 0.20	1.425 ± 0.377	1.425 ± 0.377	mm
CSNL 2 (4.5mΩ)	6.35 ± 0.25	3.18 ± 0.25	0.58 ± 0.20	1.425 ± 0.377	1.425 ± 0.377	mm
CSNL 2 (5mΩ)	6.35 ± 0.25	3.18 ± 0.25	0.50 ± 0.20	1.425 ± 0.377	1.425 ± 0.377	mm
CSNL 2 (5.5mΩ)	6.35 ± 0.25	3.18 ± 0.25	0.47 ± 0.20	1.425 ± 0.377	1.425 ± 0.377	mm
CSNL 2 (6mΩ)	6.35 ± 0.25	3.18 ± 0.25	0.50 ± 0.20	1.425 ± 0.377	1.425 ± 0.377	mm
CSNL 2 (6.5mΩ)	6.35 ± 0.25	3.18 ± 0.25	0.47 ± 0.20	1.425 ± 0.377	1.425 ± 0.377	mm
CSNL 2 (7mΩ)	6.35 ± 0.25	3.18 ± 0.25	0.45 ± 0.20	1.425 ± 0.377	1.425 ± 0.377	mm
CSNL 2 (10mΩ)	6.50 ± 0.35	3.20 ± 0.25	0.80 ± 0.15	1.900 ± 0.150	1.900 ± 0.150	mm
CSNL 3	6.35 ± 0.25	3.18 ± 0.25	0.70 ± 0.20	1.425 ± 0.377	1.425 ± 0.377	mm

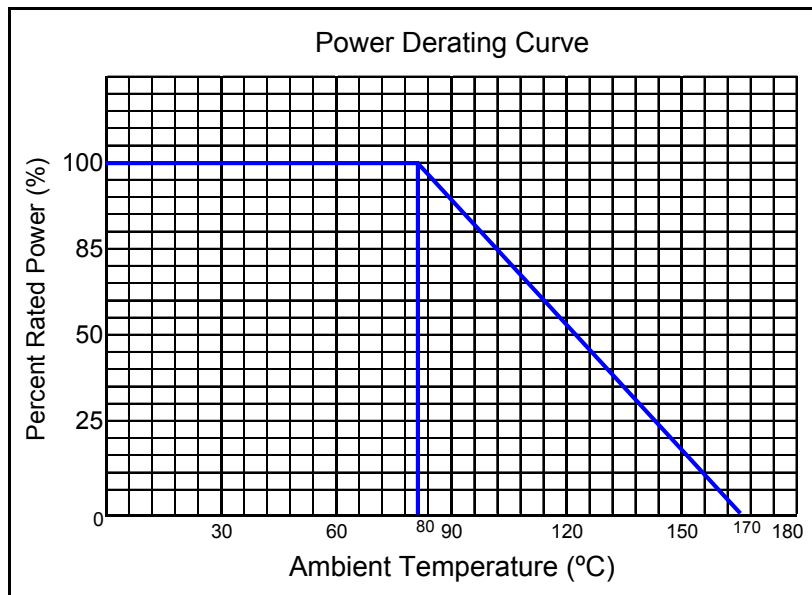

HLD Series

High Current Shunt / Sensing Resistor

Stackpole Electronics, Inc.

Resistive Product Solutions

- Features:
- ✓ Values from 0.003 to 0.1
 - ✓ Suitable for high current applications where standard current sense resistor will not survive
 - ✓ Current handling up to 100 amps
 - ✓ Handles 1W to 5W of power
 - ✓ Various wire alloys and sizes allow for value, tolerance, and TC flexibility; contact factory for specific combination of alloy and Temperature Coefficient of Resistance.



Electrical Specifications				
Type / Code	Power Rating (Watts) @ 25°C	Resistance Temperature Coefficient	Ohmic Range and Tolerance	
			2%	5%, 10%
HLD 1	1W	±100 ppm/°C - ±50 ppm/°C	0.03Ω - 0.1Ω	0.003Ω - 0.1Ω
HLD 3	3W	±100 ppm/°C - ±50 ppm/°C	0.03Ω - 0.1Ω	0.003Ω - 0.1Ω
HLD 5	5W	±100 ppm/°C - ±50 ppm/°C	0.03Ω - 0.1Ω	0.003Ω - 0.1Ω

Style A

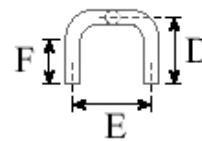
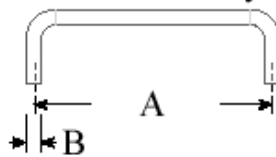

Style B

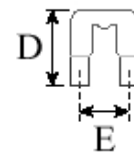
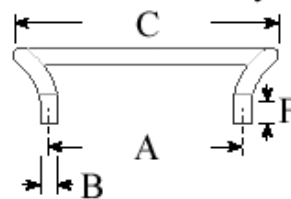

Mechanical Specifications								
Type / Code	Style	A Lead Spacing	B Lead Diameter	C Total Length	D Height	E Lead Width	F Type to Bend	Units
HLD 1	A	1.10 ± 0.10	0.04	-	0.20 ± 0.15	0.20 ± 0.01	0.1	inches
		27.94 ± 2.54	1.02	-	5.08 ± 3.81	5.08 ± 0.254	2.54	mm
HLD 3	B	1.00 ± 0.10	0.081	1.40 max	0.45 ± 0.10	0.25 ± 0.01	0.1	inches
		25.40 ± 2.54	2.06	25.56 max	11.43 ± 2.54	6.35 ± 0.254	2.54	mm
HLD 5	B	1.00 ± 0.10	0.081	1.40 max	0.45 ± 0.10	0.25 ± 0.01	0.1	inches
		25.40 ± 2.54	2.06	25.56 max	11.43 ± 2.54	6.35 ± 0.254	2.54	mm

How to Order

SEI Type		Code		Nominal Resistance	Tolerance	Packaging			
HLD		1		0.1	2%	A			
Type	Description	Code	Wattage	Tolerance		SEI Types	Pkg Qty	Description	Code
HLD	Current Shunt	1	1W	2%		ALL	100	Bulk	A
		3	3W	5%					
		5	5W	10%					

Performance Characteristics			
Test	Test Method	Test Specification	Typical
Load Life	MIL-STD-502F-Method 108A RCWW at 70°C; 1.5hr ON, 0.5hr OFF Total 1024 ± 24hrs	± 5%	≤ 5%
Short Time Overload	JIS-C-5202-5.5 5x rated power for 5 sec	± 2%	≤ 2%
Thermal EMF ¹	-	± 40 μV/°C	-

Operating Temperature Range: -55°C to +275°C

¹ Thermal EMF dependant on Alloy selection; Contact Factory

MR/TMR Series

Low Resistance Value – Molded 2 and 4 Leads

Stackpole Electronics, Inc.

Resistive Product Solutions

- Features:
- ✓ Metal element resistors
 - ✓ Excellent load life stability
 - ✓ Inherently non-inductive
 - ✓ Tinned copper leads – 10 lbs. pull
 - ✓ Low temperature coefficient
 - ✓ RoHS compliant / lead-free
 - ✓ High power to size ratio
 - ✓ Molded bodies
 - ✓ Two or four terminals
 - ✓ TMR – Kelvin Bridge Test
 - ✓ Cut and formed product is available on selected sizes
- Contact factory for details



Electrical Specifications					
Type / Code	Power Rating (Watts) @ 70°C	Short Time Overload	Dielectric Strength	Resistance Temperature Coefficient	Ohmic Range and Tolerance
					1%, 5%
MR 1	1W	5 sec. at 5x rated power	500 VAC	±50 to ±400 ppm/°C [ⓐ]	0.01Ω - 0.1Ω
MR 3	3W	5 sec. at 5x rated power	500 VAC	±50 to ±400 ppm/°C [ⓐ]	0.005Ω - 0.2Ω
MR 5	5W	5 sec. at 5x rated power	500 VAC	±50 to ±400 ppm/°C [ⓐ]	0.005Ω - 0.3Ω
MR 10	10W	5 sec. at 5x rated power	500 VAC	±50 to ±400 ppm/°C [ⓐ]	0.01Ω - 0.5Ω
TMR 3	3W	5 sec. at 5x rated power	500 VAC	±40 ppm/°C	0.005Ω - 0.2Ω
TMR 5	5W	5 sec. at 5x rated power	500 VAC	±40 ppm/°C	0.005Ω - 0.3Ω

[ⓐ]TCR is value dependent. Contact factory for specific data.

Performance Characteristics	
Test	Test Results
Moisture Resistance	±5%
Thermal Shock	±2%
Load Life @ 70°C - 1,000 hrs.	±5%
Resistance to Soldering Heat	±2%
Short Time Overload	±2%
Dielectric Withstanding Voltage	±2%

Operating Temperature Range: -55°C to +275°C

How to Order

SEI Type		Code	Nominal Resistance	Tolerance	Packaging			
MR		3	0.1	1%	R			
Type	Description	Code		Tolerance	Type	Pkg Qty	Description	Code
MR	2Leads	1		1%	MR 1	2,000	Reel	R
TMR	4 Leads	3		5%	MR 3	750		
		5			MR 5	500		
		10			MR 10	250		
					MR 1, MR 3, MR 5	1,000	Bulk	B
					MR 10	500		
					TMR 3, TMR 5	100		

MR

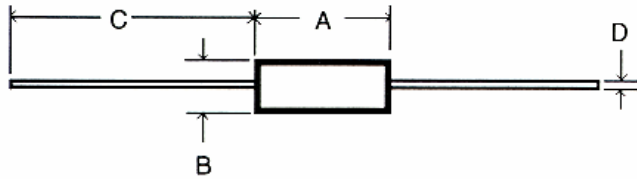

TMR

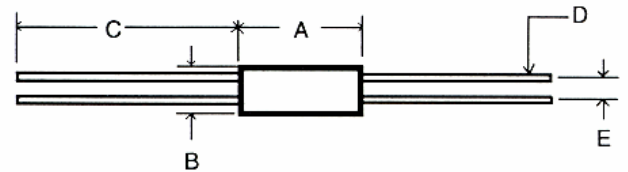

Mechanical Specifications

Type / Code	A Body Length	B Body Diameter	C Lead Length	D Lead Diameter	E Lead Spacing	Units
Tolerance	±0.015 ±0.4	±0.015 ±0.4	±0.125 ±3.4	±0.002 ±0.05	-	inches mm
MR 1	0.385 9.8	0.135 3.4	1.375 34.9	0.032 0.81	-	inches mm
MR 3	0.56 14.2	0.205 5.2	1.375 34.9	0.032 0.81	-	inches mm
MR 5	0.925 23.5	0.33 8.4	1.375 34.9	0.036 0.91	-	inches mm
MR 10	1.925 46.4	0.475 10	1.375 34.9	0.036 0.91	-	inches mm
TMR 3	0.625 15.9	0.205 5.2	1.375 34.9	0.032 0.81	0.125 3.2	inches mm
TMR 5	0.94 23.9	0.33 8.4	1.375 34.9	0.036 0.91	0.2 5.1	inches mm

Power Derating Curve

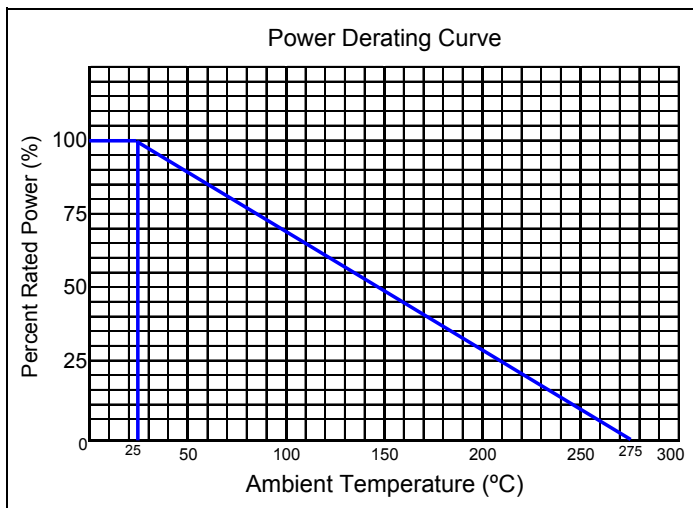

TCR vs Resistance

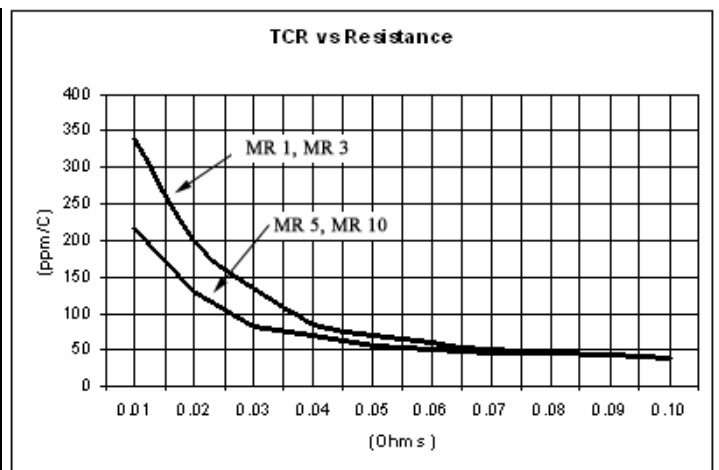

- Features:
- ✓ Small size with high power ratio
 - ✓ Low resistance values and low inductance
 - ✓ Crimped leads keep circuit board temperatures cooler
 - ✓ RoHS compliant / lead-free

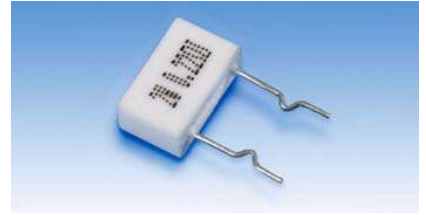

Electrical Specifications						
Type / Code	Power Rating (Watts) @ 70°C	Maximum Working Voltage	Maximum Overload Voltage	TCR	Ohmic Range and Tolerance	
					5%	10%
MPR 3	3W	350V	700V	350 ppm/°C	0.01Ω - 1Ω	0.01Ω - 1Ω
MPR 5	5W					
MPRT 2	2W + 2W				0.22Ω - 0.56Ω	0.03Ω - 0.56Ω
MPRT 3	3W + 3W					
MPRT 5	5W + 5W					
MPRT 7	7W + 7W					

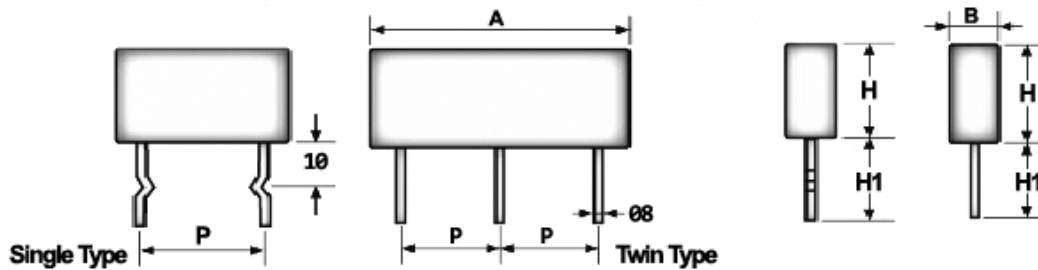

Mechanical Specifications						
Type / Code	A	B	H	H1	P	Units
Tolerance	±0.0394 ±1	0.0394 1	0.0394 1	0.0394 1	0.0394 1	inches mm
MPR 3	0.5512 14	0.1969 5	0.5118 13	0.5118 13	0.3937 10	inches mm
MPR 5	0.5512 14	0.1969 5	0.7087 18	0.5118 13	0.3937 10	inches mm
MPRT 2	1.0236 26	0.1969 5	0.3346 8.5	0.5118 13	0.3937 10	inches mm
MPRT 3	1.0236 26	0.1969 5	0.5118 13	0.5118 13	0.3937 10	inches mm
MPRT 5	1.0236 26	0.1969 5	0.7087 18	0.5118 13	0.3937 10	inches mm
MPRT 7	1.0236 26	0.1969 5	0.7874 20	0.5118 13	0.3937 10	inches mm

How to Order

SEI Type		Code		Resistance		Tolerance		Packaging			
MPR		3		0.47		5%		B			
Type	Description	Code	Wattage			Tolerance		Type	Qty	Description	Code
MPR	Single	2	2W			5%		All	1,000	Bulk	B
MPRT	Twin	3	3W			10%					
		5	5W								
		7	7W								

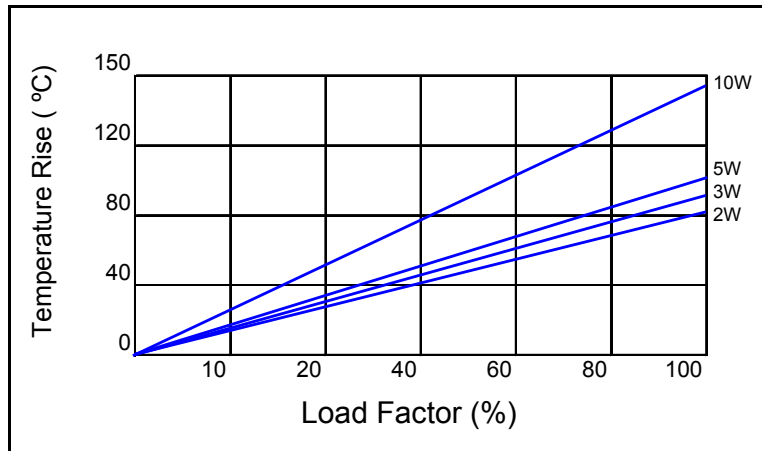
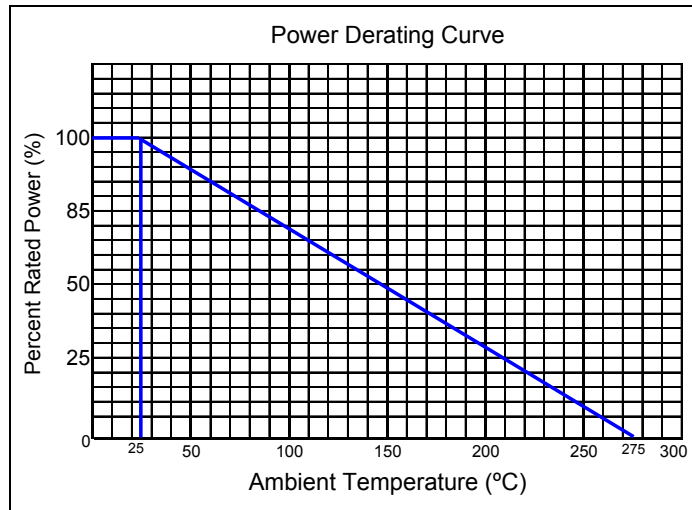

Performance Characteristics	
Test	Test Results
Short Time Overload	2% ± 0.05
Humidity Load Life	3% ± 0.05
Temp Cycling	2% ± 0.05
Resistance to Soldering Heat	2% ± 0.05
Load Life @ 70°C - 1,000 hours	3% ± 0.05

BR Series

Bare Element Current Sense Resistors

Stackpole Electronics, Inc.

Resistive Product Solutions

Features:

- ✓ 1, 3 and 5 watts
- ✓ ±1%, ±2% or ±5% tolerance
- ✓ Resistance wire TCR ±20ppm/°C
- ✓ Low inductance versions available for high frequency applications
- ✓ All welded construction
- ✓ Flameproof
- ✓ Non-inductive (10 nH max)
- ✓ Solderable copper leads (60/40)
- ✓ High current handling to 70 amps
- ✓ RoHS compliant / lead-free



Applications:

- ✓ Current sensing
- ✓ Feedback
- ✓ Low inductance
- ✓ Surge and pulse

Electrical Specifications				
Type / Code	Power Rating (Watts) at 85°C	Resistance Temperature Coefficient ^①	Ohmic Range and Tolerance	
			1%	2%, 5%
BR 1	1 W	±100ppm/°C - ±20ppm/°C	0.003Ω - 0.1Ω	0.003Ω - 0.1Ω
BR 3	3 W	±100ppm/°C - ±20ppm/°C	0.0025Ω - 0.1Ω	0.0025Ω - 0.1Ω
BR 5	5 W	±100ppm/°C - ±20ppm/°C	0.003Ω - 0.05Ω	0.003Ω - 0.05Ω

① Contact factory for resistance values below 0.005Ω

Performance Characteristics	
Test	Test Results
Moisture Resistance	± 1%
Load Life @ 25°C - 1,000 hrs.	± 1%
Short Time Overload	± 0.5%
Temperature Cycle @ -40°C & +125°C (1,000 cyc)	± 1%

How to Order

SEI Type		Code		Nominal Resistance	Tolerance	Packaging		
BR		1		0.1	5%	B		
Type	Description	Code	Wattage	Tolerance		Code	Description	Pkg Qty
BR	Current Sense	1	1 W	1%		B	Bulk	1,000
		3	3 W	2%				
		5	5 W	5%				

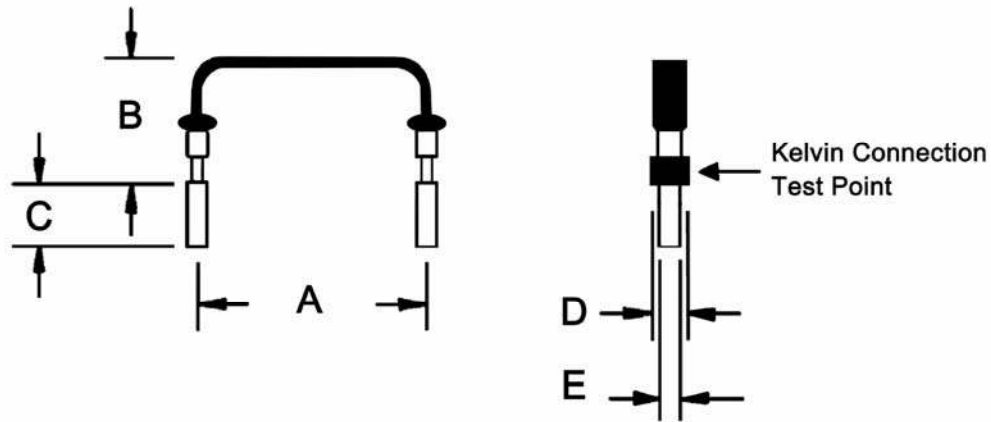

Mechanical Specifications						
Type / Code	A	B	C	D	E	Units
BR 1	0.45 + 0.04/-0.02 11.43 + 1.02/-0.508	0.2 ± 0.1 5.08 ± 2.54	0.125 ± 0.03 3.18 ± 0.762	0.065 ± 0.01/-0.005 1.65 ± 0.254/-0.127	0.04 ± 0.002 1.02 ± 0.051	inches mm
BR 3	0.6 + 0.04/-0.02 15.3 + 1.02/-0.508	0.6 Typ - 1 Max 15.3 Typ - 25.4 Max	0.125 ± 0.03 3.18 ± 0.762	0.065 ± 0.01/-0.005 1.65 ± 0.254/-0.127	0.04 ± 0.002 1.02 ± 0.051	inches mm
BR 5	0.8 + 0.04/-0.02 20.32 + 1.02/-0.508	0.6 Typ - 1 Max 15.3 Typ - 25.4 Max	0.125 ± 0.03 3.18 ± 0.762	0.065 ± 0.01/-0.005 1.65 ± 0.254/-0.127	0.04 ± 0.002 1.02 ± 0.051	inches mm

- Features:
- ✓ Precision metal film
 - ✓ Superior electrical, TCR performances
 - ✓ Flame-retardant coatings are standard
 - ✓ Panasert available (selected sizes: contact factory)
 - ✓ RNM (mini) an ideal choice where size constraints apply
 - ✓ RN 5% replaces MP series
 - ✓ RoHS compliant / lead-free available (RNF/RNMF)
 - ✓ Lower or higher resistance values may be possible (contact factory)



Electrical Specifications											
Type / Code	Mil Ref	Power Rating (Watts) @ 70°C	Maximum Working Voltage Φ	Maximum Overload Voltage	Resistance Temperature Coefficient	Ohmic Range and Tolerance					
						0.1%	0.25%	0.5%	1%	2%	5%
RN 1/8	RN 50	0.125W	200V	400V	± 25 ppm/°C	100 Ω - 100K	100 Ω - 100K	49.9 Ω - 499K	49.9 Ω - 499K	-	-
					± 50 ppm/°C	100 Ω - 100K	100 Ω - 100K	10 Ω - 499K	10 Ω - 1M	-	-
					± 100 ppm/°C	100 Ω - 100K	100 Ω - 100K	10 Ω - 511K	1 Ω - 22M	1 Ω - 22M	1 Ω - 22M
RN 1/4	RN 55	0.250W	250V	500V	± 10 ppm/°C	100 Ω - 100K	-	-	-	-	-
					± 25 ppm/°C	10 Ω - 2.2M	10 Ω - 2.2M	10 Ω - 2.2M	10 Ω - 1M	-	-
					± 50 ppm/°C	10 Ω - 2.2M	10 Ω - 2.2M	10 Ω - 2.2M	10 Ω - 1M	-	-
					± 100 ppm/°C	10 Ω - 2.2M	10 Ω - 2.2M	10 Ω - 2.2M	10 Ω - 1M	1 Ω - 10M	1 Ω - 10M
RN 1/2	RN 60	0.500W	350V	700V	± 25 ppm/°C	100 Ω - 100K	100 Ω - 100K	49.9 Ω - 499K	49.9 Ω - 499K	-	-
					± 50 ppm/°C	100 Ω - 100K	100 Ω - 100K	10 Ω - 511M	10 Ω - 1M	-	-
					± 100 ppm/°C	100 Ω - 100K	100 Ω - 100K	10 Ω - 511M	1 Ω - 5.1M	1 Ω - 10M	1 Ω - 10M
RN 1	RN 65	1.000W	350V	700V	± 25 ppm/°C	-	-	10 Ω - 511K	10 Ω - 1M	-	-
					± 50 ppm/°C	-	-	10 Ω - 511K	10 Ω - 1M	-	-
					± 100 ppm/°C	-	-	10 Ω - 511K	10 Ω - 1M	-	-
RN 2	-	2.000W	350V	800V	± 25 ppm/°C	-	-	10 Ω - 511K	10 Ω - 1M	-	-
					± 50 ppm/°C	-	-	10 Ω - 511K	10 Ω - 1M	-	-
					± 100 ppm/°C	-	-	10 Ω - 511K	10 Ω - 1M	-	10 Ω - 1M
RNM 1/4	-	0.250W	200V	400V	± 25 ppm/°C	100 Ω - 100K	100 Ω - 100K	49.9 Ω - 499K	49.9 Ω - 499K	-	-
					± 50 ppm/°C	100 Ω - 100K	100 Ω - 100K	10 Ω - 511K	10 Ω - 1M	-	-
					± 100 ppm/°C	100 Ω - 100K	100 Ω - 100K	10 Ω - 511K	10 Ω - 1M	1 Ω - 1M	1 Ω - 1M
RNM 1/2	RL 07	0.500W	350V	600V	± 25 ppm/°C	100 Ω - 100K	100 Ω - 100K	49.9 Ω - 499K	49.9 Ω - 499K	-	-
					± 50 ppm/°C	49.9 Ω - 1M	49.9 Ω - 1M	10 Ω - 1M	1 Ω - 1M	-	-
					± 100 ppm/°C	49.9 Ω - 1M	49.9 Ω - 1M	10 Ω - 1M	1 Ω - 1M	1 Ω - 1M	1 Ω - 1M

① Lesser of \sqrt{PR} or maximum working voltage.

How to Order

SEI Type		Code	TCR	Nominal Resistance	Tolerance	Packaging				
RN		1/4	T1	4.75K	1%	R				
Type	Description	Code	TCR		Tolerance	Values	SEI Types	Pkg Qty	Code	Description
RN	EIA standard	1/8	T1	100ppm	0.1%	E96	1/8, 1/4, RNM 1/2	5,000	R	Reel
RNM	Mini	1/4	T2	50ppm	0.25%	E96	1/2, 1	2,500	T	Ammo
RNF	Standard RoHS	1/2	T9	25ppm	0.5%	E96	1/8, RNM 1/2	5,000		
RNMF	Mini RoHS	1	TB	10ppm	1%	E96, E24	1/4	2,500		
PRN	Panasert	2			5%	E24	1/2	2,000		
PRNF	Pana - RoHS						1	1,000		
							1/8, 1/4, 1/2	1,000	A	Bulk
									R	Reel
							2	1,000	T	Ammo
									A	Bulk

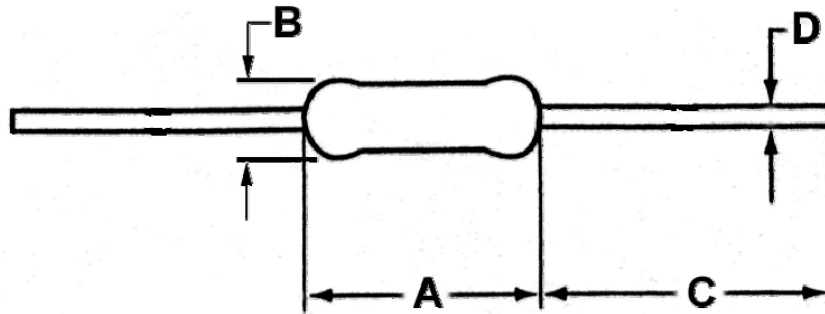

Mechanical Specifications					
Type / Code	A Body Length	B Body Diameter	C Lead Length (Bulk)	D Lead Diameter	Units
RN 1/8	0.13 ± 0.012	0.070 ± 0.012	1.10 ± 0.12	0.018 ± 0.003	inches
	3.3 ± 0.3	1.8 ± 0.3	28 ± 3	0.45 ± 0.07	mm
RN 1/4	0.25 ± 0.026	0.093 ± 0.010	1.10 ± 0.12	0.022 ± 0.003	inches
	6.35 ± 0.65	2.35 ± 0.25	28 ± 3	0.56 ± 0.08	mm
RN 1/2	0.34 ± 0.030	0.108 ± 0.039	1.10 ± 0.197	0.26 ± 0.004	inches
	8.75 ± 0.75	2.75 ± 1.0	28 ± 5	0.65 ± 0.1	mm
RN 1	0.433 ± 0.04	0.177 ± 0.02	1.18 ± 0.12	0.030 ± 0.002	inches
	11 ± 1	4.50 ± 0.5	30 ± 3	0.75 ± 0.05	mm
RN 2	0.59 x 0.04	0.2 x 0.02	1.18 ± 0.12	0.027 x 0.004	inches
	15 x 1	5 x 0.5	30 ± 3	0.7 x 0.1	mm
RNM 1/4	0.13 ± 0.011	0.070 ± 0.003	1.10 ± 0.12	0.017 ± 0.002	inches
	3.3 ± 0.3	1.78 ± 0.08	28 ± 3	0.44 ± 0.05	mm
RNM 1/2	0.25 ± 0.026	0.093 ± 0.010	1.10 ± 0.12	0.022 ± 0.003	inches
	6.35 ± 0.65	2.35 ± 0.25	28 ± 3	0.56 ± 0.08	mm

Performance Characteristics		
Test	Standard / Method	Requirement
Biased Humidity	MIL-STD 202, Method 103	± 1.5%
Resistance to Solder Heat	MIL-STD 202, Method 210	± 0.5%
Insulation Resistance	JIS C 5202 5.6	± 0.5%
Load Life	MIL-STD 202, Method 208	± 1%
Terminal Strength	MIL-STD 202, Method 211	± 0.2%
Temperature Cycling	JESD22 Method JA-104	± 1%
Moisture Resistance	MIL-STD 202, Method 106	± 0.5%

Operating Temperature Range: -55°C to +155°C

- Features:
- ✓ Lower-cost alternative to carbon comps and wirewounds
 - ✓ Coating meets UL 94V-0
 - ✓ Meets solvent test of Mil Standard 202, Method 215
 - ✓ Cut and formed product is available on select sizes; contact factory for details
 - ✓ Higher or lower resistance values may be possible; contact factory
 - ✓ RoHS compliant / lead-free available (RSF, RSMF)



Electrical Specifications							
Type / Code	Power Rating (Watts) @ 70°C	Maximum Working Voltage [Ⓞ]	Maximum Overload Voltage	Dielectric Withstanding Voltage	Resistance Temperature Coefficient	Ohmic Range and Tolerance	
						1%	2%, 5%
RS 1/2	0.5W	250V	400V	600V	±200 ppm/°C	0.1Ω - 75KΩ	0.1Ω - 1MΩ
RS 1	1W	350V	600V	600V	±200 ppm/°C	0.1Ω - 100KΩ	0.1Ω - 1MΩ
RS 2	2W	350V	600V	600V	±200 ppm/°C	0.1Ω - 120KΩ	0.1Ω - 1MΩ
RS 3	3W	400V	700V	600V	±200 ppm/°C	10Ω - 510KΩ	10Ω - 510KΩ
RS 5	5W	750V	1,000V	1,000V	±200 ppm/°C	10Ω - 510KΩ	10Ω - 510KΩ
RSM 1/2	0.5W	250V	400V	350V	±200 ppm/°C	0.1Ω - 47KΩ	0.1Ω - 1MΩ
RSM 1	1W	350V	600V	500V	±200 ppm/°C	0.1Ω - 75KΩ	0.1Ω - 1MΩ
RSM 2	2W	350V	600V	500V	±200 ppm/°C	0.1Ω - 100KΩ	0.1Ω - 1MΩ
RSM 3	3W	500V	800V	500V	±200 ppm/°C	0.1Ω - 118KΩ	0.1Ω - 1MΩ
RSM 5	5W	750V	1,000V	750V	±200 ppm/°C	1Ω - 510KΩ	1Ω - 510KΩ

Ⓞ Lesser of \sqrt{PR} or maximum working voltage

How to Order

SEI Type		Code		Nominal Resistance	Tolerance	Packaging			
RS		1/2		0.47	5%	R			
Type	Description	Code	Wattage	Tolerance Values		Types	Qty	Description	Code
RS	EIA Standard	1/2	0.5W	1%	E96	RSM 1/2	5,000	Tape	R
RSM	Mini	1	1W	2%	E24	RS 1/2, RSM 1, RS 1, RSM 2	2,500		
RSF	Standard RoHS	2	2W	5%	E24	RS 2, RSM 3	1,000		
RSMF	Mini RoHS	3	3W			RS 3, RSM 5	500	Ammo	T
PRSF [Ⓞ]	Panasert	5	5W			RSM 1/2	5,000		
PRSF [Ⓞ]	Panasert RoHS					RS 1/2, RSM 1	2,000		
						RS 1, RS 2, RSM 2, RSM 3	1,000		
						RS 3, RSM 5	500	Bulk	A
						All	1,000		

Ⓞ For packaging information see Radial Leaded Packaging Spec page

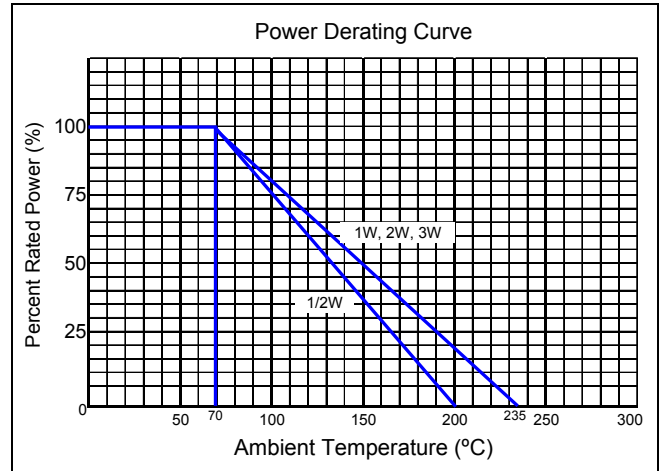
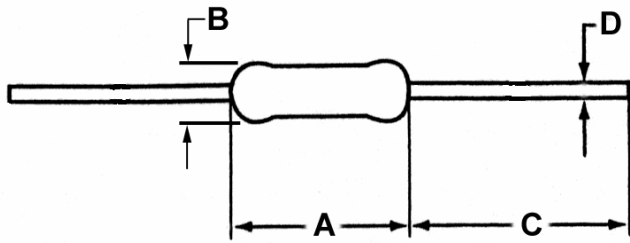

Mechanical Specifications

Type / Code	A Body Length	B Body Diameter	C Lead Length (Bulk)	D Lead Diameter	Units
RS 1/2	0.35 ± 0.04	0.14 ± 0.02	1.1 ± 0.12	0.024 ± 0.003	inches
	9 ± 1	3.5 ± 0.5	28 ± 3	0.6 ± 0.01	mm
RS 1	0.43 ± 0.04	0.18 ± 0.02	1.1 ± 0.20	0.028 ± 0.004	inches
	11 ± 1	4.5 ± 0.5	28 ± 5	0.7 ± 0.1	mm
RS 2	0.59 ± 0.04	0.2 ± 0.04	1.26 ± 0.24	0.029 ± 0.004	inches
	15 ± 1	5 ± 1	32 ± 6	0.75 ± 0.1	mm
RS 3	0.71 ± 0.08	0.26 ± 0.02	1.38 ± 0.12	0.031 ± 0.002	inches
	17.5 ± 2	6.5 ± 0.5	35 ± 3	0.8 ± 0.05	mm
RS 5	0.96 ± 0.08	0.34 ± 0.02	1.38 ± 0.12	0.031 ± 0.002	inches
	24.5 ± 2	8.5 ± 0.5	35 ± 3	0.8 ± 0.05	mm
RSM 1/2	0.26 ± 0.02	0.09 ± 0.01	1.1 ± 0.12	0.02 ± 0.003	inches
	6.5 ± 0.5	2.3 ± 0.2	28 ± 3	0.55 ± 0.07	mm
RSM 1	0.35 ± 0.04	0.13 ± 0.02	1.1 ± 0.12	0.026 ± 0.003	inches
	9 ± 1	3.2 ± 0.6	28 ± 3	0.65 ± 0.01	mm
RSM 2	0.43 ± 0.04	0.17 ± 0.03	1.18 ± 0.20	0.029 ± 0.004	inches
	11 ± 1	4.2 ± 0.8	30 ± 5	0.75 ± 0.1	mm
RSM 3	0.59 ± 0.04	0.2 ± 0.04	1.26 ± 0.24	0.029 ± 0.004	inches
	15 ± 1	5 ± 1	32 ± 6	0.75 ± 0.1	mm
RSM 5	0.71 ± 0.08	0.26 ± 0.02	1.38 ± 0.08	0.031 ± 0.002	inches
	17.5 ± 2	6.5 ± 0.5	35 ± 2	0.8 ± 0.05	mm

Performance Characteristics

Test	Standard / Method	Requirement	
		RSM Series	RS Series
Short Time Over Load	JISC 5202 5.5	± 2%	±1%
Biased Humidity	MIL-STD 202, Method 103	± 1.5%	
Dielectric Withstanding Voltage	MIL-STD 202, Method 103	± 0.5%	
Load Life	MIL-STD 202, Method 103	± 2%	
Load Life in Humidity	JISC 5202 7.9	± 2%	
Temperature Cycling	JESD22 Method JA-104	± 1%	
Low Temperature Operation	MIL-STD 202, Method 103	± 0.5%	
Moisture Resistance	MIL-STD 202, Method 103	± 0.5%	
Resistance to Solder Heat	MIL-STD 202, Method 210F	± 1%	
Terminal Strength	MIL-STD 202, Method 103	± 0.2%	
Vibration	MIL-STD 202, Method 103	± 0.5%	

Operating Temperature Range: -55°C to +200°C (RS 1/2, RSM 1)
-55°C to +235°C (All others)

- Features:
- ✓ Excellent anti-surge characteristics
 - ✓ Stable characteristics through the resistance range
 - ✓ Good alternative to carbon composition resistors
 - ✓ Applications include power supplies, CRT's, and anti-surge circuits
 - ✓ Cut and formed product is available on select sizes; contact factory for details
 - ✓ RoHS compliant / lead-free



Electrical Specifications						
Type / Code	Power Rating (Watts) @ 70°C	Maximum Working Voltage ①	Maximum Overload Voltage	Surge Withstanding	Ohmic Range and Tolerance	
					5%	10%
ASRM 1/4	0.25W	500V	1,000V	2KV	100KΩ - 10MΩ	-
ASR 1/4	0.25W	500V	1,000V	1KV	100Ω - 510KΩ	20MΩ - 33MΩ
				3KV	510KΩ - 18MΩ	-
ASRM 1/2	0.50W	700V	1,000V	5KV	100Ω - 510KΩ	-
				10KV	560KΩ - 910KΩ	22MΩ - 33MΩ
ASR 1	1.00W	1,000V	1,500V	5KV	100Ω - 510KΩ	-
				10KV	560KΩ - 910KΩ	22MΩ - 33MΩ
					13MΩ - 20MΩ	

① Lesser of \sqrt{PR} or maximum working voltage.

How to Order

SEI Type		Code		Nominal Resistance	Tolerance	Packaging			
ASR		1/2		100K	5%	R			
Code	Description	Code	Wattage		Tolerance	SEI Types	Pkg Qty	Description	Code
ASR	Standard	1/4	0.25W		5%	ASRM 1/4	2,000	Bulk	A
ASRM	Mini	1/2	0.5W		10%	ASR 1/4, ASRM 1/2, ASR 1	1,000		
		1	1W			ASRM 1/4	5,000	Ammo	T
						ASR 1/4, ASRM 1/2	2,000		
						ASR 1	500		

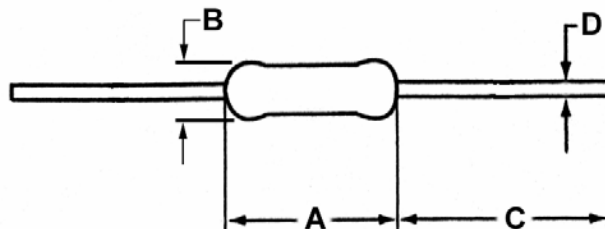

Mechanical Specifications					
Type / Code	A Body Length	B Body Diameter	C Lead Length(Bulk)	D Lead Diameter	Units
ASRM 1/4	0.13 ± 0.01	0.07 ± 0.01	1.10 ± 0.08	0.018 ± 0.002	inches
	3.2 ± 0.2	1.85 ± 0.02	28.0 ± 2.0	0.45 ± 0.05	mm
ASR 1/4	0.24 ± 0.01	0.09 ± 0.01	1.10 ± 0.08	0.022 ± 0.002	inches
	6.0 ± 0.2	2.30 ± 0.02	28.0 ± 2.0	0.55 ± 0.05	mm
ASRM 1/2	0.35 ± 0.01	0.12 ± 0.02	1.10 ± 0.08	0.027 ± 0.002	inches
	9.0 ± 0.2	3.00 ± 0.50	28.0 ± 2.0	0.70 ± 0.05	mm
ASR 1	0.59 ± 0.01	0.20 ± 0.02	1.10 ± 0.08	0.031 ± 0.002	inches
	15.0 ± 0.2	5.00 ± 0.50	28.0 ± 2.0	0.80 ± 0.05	mm

Performance Characteristics	
Test	Test Results
Moisture Resistance	± 5%
Temperature Cycling	± 1%
Load Life	± 5%
Resistance to Soldering Heat	± 1%
Overload (short time)	± (2%+0.05Ω)
Discharge	± (10%+0.05Ω)

Operating Temperature Range: -55°C to +155°C

- Features:
- ✓ UL 1676 recognized
 - ✓ Excellent anti-surge characteristics
 - ✓ Stable characteristics through the resistance range
 - ✓ Applications include power supplies, CRT's and anti-surge circuits
 - ✓ Good alternative to carbon composition resistors
 - ✓ Cut and formed product is available on select sizes; contact factory for details
 - ✓ RoHS compliant / lead-free

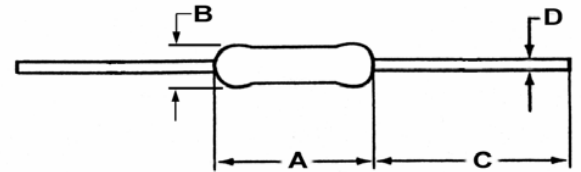

Electrical Specifications					
Type / Code	Power Rating (Watts) @ 70°C	Maximum Working Voltage [ⓐ]	Maximum Overload Voltage	Surge Withstanding Voltage	Ohmic Range and Tolerance
					5%, 10%
SPRM 1/2	0.5W	2,000V	3,000V	10KV	1MΩ - 12MΩ
SPR 1	1W				

[ⓐ]Lesser of \sqrt{PR} or maximum working voltage

Mechanical Specification					
Type / Code	A Body Length	B Body Diameter	C Lead Length (Bulk)	D Lead Diameter	Units
SPRM 1/2	0.35 ± 0.03 9 ± 1	0.12 ± 0.02 3 ± 0.5	1.1 ± 0.08 28 ± 2	0.027 ± 0.002 0.7 ± 0.05	inches mm
SPR 1	0.59 ± 0.04 15 ± 1	0.2 ± 0.02 5 ± 0.5	1.38 ± 0.12 35 ± 3	0.031 ± 0.002 0.8 ± 0.05	inches mm

Performance Characteristics (JIS C 5201-1)	
Test	Test Results
Moisture Resistance	±5%
Temperature Cycling	±1%
Load Life	±5%
Resistance to Soldering Heat	±1%
Short Time Overload	±2%
Discharge	±10%

Operating Temperature Range: -55°C to +155°C

How to Order

SEI Type		Code		Nominal Resistance		Tolerance		Packaging			
SPR		1		10M		5%		A			
Type	Description	Code	Wattage	Tolerance	Values	Type	Qty	Description	Code		
SPR	EIA Standard	1/2	0.5W	5%	E24	SPRM 1/2, SPR 1	1,000	Bulk	A		
SPRM	Mini	1	1W	10%	E12	SPRM 1/2	2,000	Ammo	T		
						SPR 1	500				

- Features:
- ✓ Flameproof design
 - ✓ Compact Size
 - ✓ Useful in circuits where duty cycles require power resistors
 - ✓ Tin-plated copper leads
 - ✓ Cut and formed product is available on select sizes; contact factory for details
 - ✓ RoHS compliant / lead-free



Electrical Specifications						
Type / Code	Power Rating (Watts) @ 70°C	Maximum Working Voltage [Ⓞ]	Maximum Pulse Voltage	Resistance Temperature Coefficient	Ohmic Range and Tolerance	
					1%	5%
RSPF 1/2	0.5W	400V	800V	-200 ppm/°C ~ +350 ppm/°C	10Ω - 100KΩ	2.2Ω - 1MΩ
RSPF 1	1W	500V	1,000V	-200 ppm/°C ~ +350 ppm/°C	10Ω - 100KΩ	2.2Ω - 1MΩ
RSPF 2	2W	500V	1,000V	-200 ppm/°C ~ +350 ppm/°C	10Ω - 100KΩ	2.2Ω - 1MΩ
RSPF 3	3W	500V	1,000V	-200 ppm/°C ~ +350 ppm/°C	10Ω - 100KΩ	2.2Ω - 1MΩ
RSPL 1/2	0.5W	√PR	√PR x 2.5	-200 ppm/°C ~ +350 ppm/°C	-	0.1Ω - 2Ω
RSPL 1	1W	√PR	√PR x 2.5	-200 ppm/°C ~ +350 ppm/°C	-	0.1Ω - 2Ω
RSPL 2	2W	√PR	√PR x 2.5	-200 ppm/°C ~ +350 ppm/°C	-	0.1Ω - 2Ω
RSPL 3	3W	√PR	√PR x 2.5	-200 ppm/°C ~ +350 ppm/°C	-	0.1Ω - 2Ω

Ⓞ Lesser of √PR or maximum working voltage

How to Order

SEI Type		Code		Nominal Resistance	Tolerance	Packaging			
RSPF		1/2		10	5%	A			
Type	Description	Code	Wattage	Tolerance		Types	Qty	Description	Code
RSPF	Flameproof	1/2	0.5W	1%		RSPF 1/2, RSPF 1, RSPL 1/2, RSPL 1	2,500	Reel	R
RSPL	Low values	1	1W	5%		RSPF 2, RSPL 2	1,000		
		2	2W			RSPF 3, RSPL 3	500		
		3	3W			RSPF 1/2, RSPF 1, RSPL 1/2, RSPL 1	2,000	Ammo	T
						RSPF 2, RSPL 2	1,000		
						RSPF 3, RSPL 3	500		
						All	1,000	Bulk	A

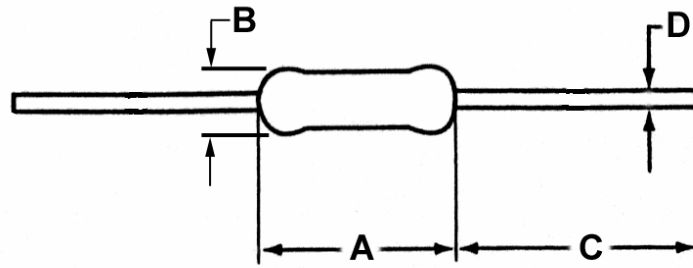

Mechanical Specifications					
Type / Code	A Body Length	B Body Diameter	C Lead Length (Bulk)	D Lead Diameter	Units
RSPF / RSPL 1/2	0.24 x 0.04 6 x 0.3	0.09 x 0.01 2.3 x 0.2	1.1 x 0.08 28 x 2	0.024 x 0.002 0.6 x 0.05	inches mm
RSPF / RSPL 1	0.35 x 0.02 9 x 0.5	0.12 x 0.02 3 x 0.5	1.1 x 0.08 28 x 2	0.028 x 0.002 0.7 x 0.05	inches mm
RSPF / RSPL 2	0.43 x 0.02 11 x 0.5	0.16 x 0.02 4 x 0.5	1.38 x 0.12 35 x 3	0.031 x 0.002 0.8 x 0.05	inches mm
RSPF / RSPL 3	0.59 x 0.02 15 x 0.5	0.22 x 0.02 5.5 x 0.5	1.38 x 0.12 35 x 3	0.031 x 0.002 0.8 x 0.05	inches mm

Performance Characteristics (JIS C 5202)	
Test	Test Results
Short Time Overload	±(0.75% + 0.05Ω)
Moisture Resistance	±(5% + 0.05Ω)
Load Life @ 70°C - 1,000 hours	±(5% + 0.05Ω)
Dielectric Withstanding Voltage	±(5% + 0.05Ω)
Resistance to Solvent	Permanent marking no physical damage or deterioration
Non-combustibility	Does not burn continuously for more than 5 seconds

Operating Temperature Range: -55°C to +155°C

- Features:
- ✓ Coating meets UL 94V-0
 - ✓ Flameproof – meets overload test of UL #1412
 - ✓ Designed for constant current to provide overload protection
 - ✓ Consistent performance and reliability
 - ✓ Cut and formed product is available on select sizes, contact factory for details
 - ✓ RoHS compliant / lead-free



Electrical Specifications					
Type / Code	Power Rating (Watts) @ 70°C	Maximum Working Voltage [ⓐ]	Maximum Working Voltage	Resistance Temperature Coefficient	Ohmic Range and Tolerance
					5%
FRN 1/4	0.25W	200V	300V	±350 ppm/°C	0.22Ω - 10KΩ
FRN 1/2	0.5W	250V	400V	±350 ppm/°C	0.47Ω - 10KΩ
FRN 1	1W	300V	600V	±350 ppm/°C	0.47Ω - 10KΩ
FRN 2	2W	300V	600V	±350 ppm/°C	1Ω - 3KΩ

ⓐ Lesser of √PR or maximum working voltage

Fusing Characteristics Magnification of Power Rating				
Type / Code	X25	X15	X12	Fusing Time
FRN 1/4	0.22Ω - 0.91Ω	1Ω - 4.7KΩ 2.4KΩ - 10KΩ	5.1Ω - 2.2KΩ	30 Sec. Maximum
FRN 1/2	-	0.47Ω - 2Ω 1.1KΩ - 10KΩ	2.2Ω - 1KΩ	
FRN 1	-	0.47Ω - 2Ω 1.1KΩ - 10KΩ	2.2Ω - 1KΩ	
FRN 2	-	1Ω - 3.6Ω 1.1KΩ - 3KΩ	3.9Ω - 1KΩ	

How to Order

SEI Type		Code		Nominal Resistance	Tolerance	Packaging				
FRN		1/2		4.7	5%	R				
Type	Description	Code	Wattage		Tolerance	Values	SEI Types	Pkg Qty	Description	Code
FRN	Fusing Metal Film	1/4	0.25W		5%	E24	FRN 1/4	5,000	Tape	R
		1/2	0.5W				FRN 1/2, 1	2,500		
		1	1W				FRN 2	1,000		
		2	2W				ALL	1,000	Ammo	T
							ALL	1000	Bulk	A

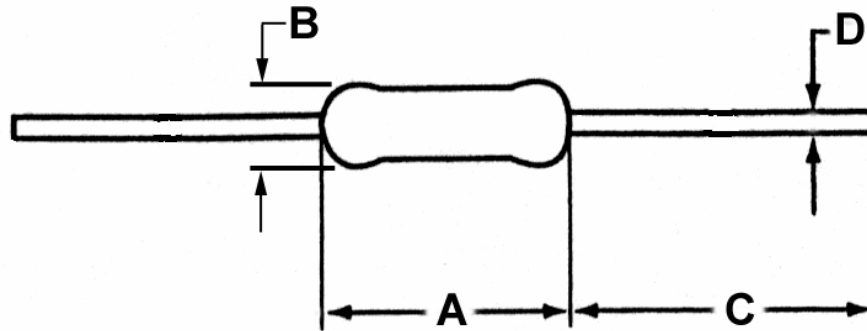

Mechanical Specifications					
Type / Code	A Body Length	B Body Diameter	C Lead Length (Bulk)	D Lead Diameter	Units
FRN 1/4	0.024 ± 0.01 6 ± 0.2	0.09 ± 0.01 2.3 ± 0.2	1.1 ± 0.08 28 ± 2	0.022 ± 0.002 0.55 ± 0.05	inches mm
FRN 1/2	0.35 ± 0.02 9 ± 0.5	0.11 ± 0.02 2.8 ± 0.5	1.1 ± 0.08 28 ± 2	0.028 ± 0.002 0.7 ± 0.05	inches mm
FRN 1	0.43 ± 0.02 11 ± 0.5	0.16 ± 0.02 4 ± 0.5	1.1 ± 0.08 28 ± 2	0.028 ± 0.002 0.7 ± 0.05	inches mm
FRN 2	0.59 ± 0.04 15 ± 1	0.22 ± 0.02 5.5 ± 0.5	1.38 ± 0.12 35 ± 3	0.031 ± 0.002 0.8 ± 0.05	inches mm

Performance Characteristics	
Test	Test Results
Moisture Resistance	±5%
Thermal Shock	±1%
Load Life @ 70°C - 1,000hrs	±5%
Resistance to Soldering Heat	±1%
Short Time Overload	±2%

Operating Temperature Range: -40°C to +155°C

- Features:
- ✓ High voltage capability from 1600 to 4000 volts
 - ✓ Inexpensive high voltage leaded resistor solution
 - ✓ High resistance values up to 200M
 - ✓ Tolerances as low as 1%, TC's as low as 100ppm/°C



Electrical Specifications						
Type / Code	Power Rating (Watts) @ 70°C	Maximum Working Voltage	Dielectric Withstanding Voltage	Resistance Range	Resistance Tolerance	Resistance Temperature Coefficient
MG 1/4	0.25W	1600V	700V	100KΩ - 200MΩ	±5% ±1%	±200 ppm/°C ±100 ppm/°C
MG 1/2	0.5W	2000V	700V			
MG 1	1W	3500V	700V			
MG 2	2W	3500V	700V			
MGM 1/2	0.5W	1800V	700V			
MGM 1	1W	2200V	700V			
MGM 2	2W	3700V	700V			
MGM 3	3W	4000V	700V			

Performance Characteristics	
Test	Requirement
Short Time Overload	± (1% + 0.05Ω)
Moisture Resistance	± (5% + 0.05Ω)
Load Life	± (3% + 0.05Ω)
Insulation Resistance	> 10,000 MΩ
Resistance to Soldering Heat	± (1% + 0.05Ω)
Temperature Cycling	± (1% + 0.05Ω)
Terminal Strength	± (1% + 0.05Ω)
Low Temperature Operation	± (1% + 0.05Ω)

How to Order

SEI Type		Code	Nominal Resistance	Tolerance	Packaging			
MG		1/2	100K	5%	R			
Type	Description	Code	Tolerance	Values	Type	Qty	Description	Code
MG	EIA Std	1/4	1%	E24	MG 1/4, MGM 1/2	5,000	Ammo	T
MGM	Mini	1/2	5%	E24	All Others	1,000		
		1			MG 1/4, MGM 1/2	5,000	Reel	R
		2			All Others	1,000		
		3						

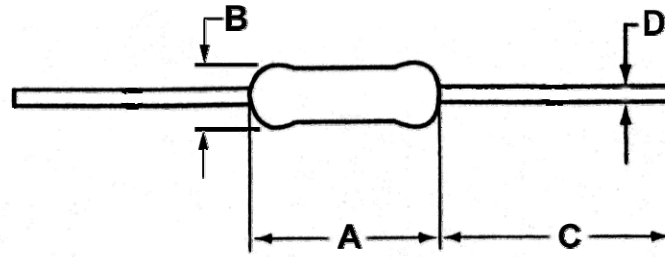

Mechanical Specifications					
Type / Code	A Body Length	B Body Diameter	C Lead Length (Bulk)	D Lead Diameter	Units
MG 1/4	0.248 ± 0.02	0.091 ± 0.012	1.102 ± 0.079	0.022 ± 0.012	inches
	6.3 ± 0.5	2.3 ± 0.3	28 ± 2	0.55 ± 0.03	mm
MG 1/2	0.354 ± 0.02	0.126 ± 0.02	1.02 ± 0.079	0.026 ± 0.012	inches
	9 ± 0.5	3.2 ± 0.5	26 ± 2	0.65 ± 0.03	mm
MG 1	0.453 ± 0.039	0.177 ± 0.02	1.378 ± 0.079	0.031 ± 0.012	inches
	11.05 ± 1	4.5 ± 0.5	35 ± 2	0.78 ± 0.03	mm
MG 2	0.61 ± 0.039	0.197 ± 0.2	1.26 ± 0.079	0.031 ± 0.012	inches
	15.5 ± 1	5 ± 0.5	32 ± 2	0.78 ± 0.03	mm
MGM 1/2	0.248 ± 0.02	0.091 ± 0.012	1.102 ± 0.079	0.022 ± 0.012	inches
	6.3 ± 0.5	2.3 ± 0.3	28 ± 2	0.55 ± 0.03	mm
MGM 1	0.354 ± 0.02	0.126 ± 0.02	1.02 ± 0.079	0.026 ± 0.012	inches
	9 ± 0.5	3.2 ± 0.5	26 ± 2	0.65 ± 0.03	mm
MGM 2	0.453 ± 0.039	0.177 ± 0.02	1.378 ± 0.079	0.031 ± 0.012	inches
	11.5 ± 1	4.5 ± 0.5	35 ± 2	0.78 ± 0.03	mm
MGM 3	0.61 ± 0.039	0.197 ± 0.02	1.260 ± 0.079	0.031 ± 0.012	inches
	15.5 ± 1	5 ± 0.5	32 ± 2	0.78 ± 0.03	mm

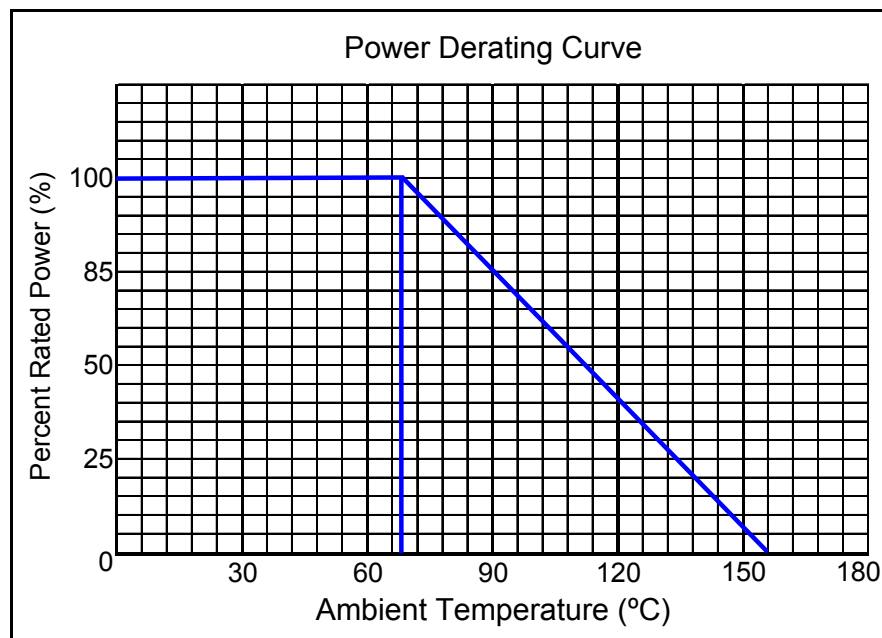

- Features:
- ✓ General purpose resistor ideal for commercial/industrial applications
 - ✓ Flame retardant coatings standard
 - ✓ Flameproof version available as CFF
 - ✓ Panasert available on selected sizes; contact factory
 - ✓ Auto sequencing/insertion compatible
 - ✓ CFM (mini) ideal choice when size constraints apply
 - ✓ Cut and formed product is available on select sizes; contact factory
 - ✓ Standard lead wire for CF/CFM is copper plated steel, with 100% tin over plate
 - ✓ 100% tin plate on copper wire is available as type CFQ/CFQM
 - ✓ RoHS compliant / lead-free



Electrical Specifications						
Type / Code	Power Rating (Watts) @ 70°C	Maximum Working Voltage ①	Maximum Overload Voltage	Dielectric Withstanding Voltage	Ohmic Range and Tolerance	
					2%	5%
CF 1/8	0.125W	250V	500V	350V	10Ω - 1MΩ	1Ω - 22MΩ
CF 1/4	0.250W	350V	600V	350V	1Ω - 1MΩ	1Ω - 22MΩ
CF 1/2	0.500W	350V	700V	600V	10Ω - 1MΩ	1Ω - 10MΩ
CF 1	1.000W	500V	1,000V	600V	1Ω - 1MΩ	1Ω - 10MΩ
CF 2	2.000W	500V	1,000V	600V	10Ω - 1MΩ	1Ω - 10MΩ
CFM 1/4	0.250W	250V	500V	350V	10Ω - 1MΩ	1Ω - 10MΩ
CFM 1/2	0.500W	350V	600V	350V	10Ω - 1MΩ	1Ω - 10MΩ

① Lesser of \sqrt{PR} or maximum working voltage.

How to Order

SEI Type		Code		Nominal Resistance	Tolerance	Packaging					
CF		1/2		100K	5%	R					
Code	Description	Code	Wattage		Tolerance	SEI Types	R Tape & Reel	A Bulk	T Tape & Box (Ammo Box)	P Panasert & Reel	Q Panasert & Box (Ammo Box)
CF	Standard	1/8	0.125W		2%	CF 1/8			5,000		
CFF	Flameproof	1/4	0.250W		5%	CF 1/4	5,000		2,000		
CFM	Mini	1/2	0.500W			CF 1/2		1,000			
PCF	Panasert CF 1/4	1	1.000W			CF 1	2,000		1,000	N/A	N/A
PCFM	Panasert CF 1/2	2	2.000W			CF 2	1,000				
CFQ	Tin plating on copper wire					CFM 1/4			5,000		
CFQM	Tin plating (mini)					CFM 1/2	5,000				
						PCF 1/4				5,000	2,000
						PCFM 1/2		N/A			

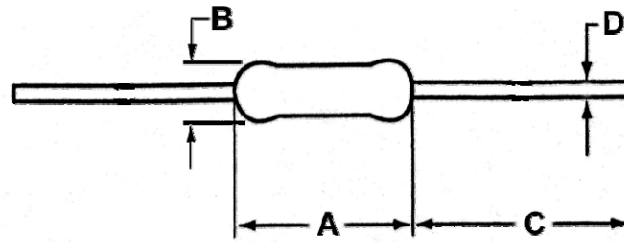

Mechanical Specifications					
Type / Code	A Body Length	B Body Diameter	C Lead Length(Bulk)	D Lead Diameter	Units
CF 1/8	0.13 ± 0.01	0.07 ± 0.01	1.10 ± 0.12	0.018 ± 0.003	inches
	3.3 ± 0.3	1.7 ± 0.3	28 ± 3	0.45 ± 0.08	mm
CF 1/4	0.26 ± 0.02	0.09 ± 0.01	1.10 ± 0.12	0.022 ± 0.003	inches
	6.5 ± 0.05	2.3 ± 0.3	28 ± 3	0.55 ± 0.08	mm
CF 1/2	0.33 ± 0.04	0.11 ± 0.02	1.18 ± 0.12	0.022 ± 0.002	inches
	8.5 ± 1	2.7 ± 0.5	30.0 ± 3	0.56 ± 0.05	mm
CF 1	0.43 ± 0.04	0.18 ± 0.02	1.18 ± 0.12	0.028 ± 0.004	inches
	11.0 ± 1	4.5 ± 0.5	30.0 ± 3	0.70 ± 0.1	inches
CFM 1/4	0.13 ± 0.01	0.07 ± 0.01	1.10 ± 0.12	0.018 ± 0.003	inches
	3.3 ± 0.3	1.7 ± 0.3	28 ± 3	0.45 ± 0.08	mm
CFM 1/2	0.26 ± 0.04	0.09 ± 0.01	1.10 ± 0.12	0.022 ± 0.003	inches
	6.5 ± 1	2.3 ± 0.3	28 ± 3	0.55 ± 0.08	mm

Performance Characteristics		
Test	Standard / Method	Test Results
Short Time Overload	EIA-RS-172-B 3.2.6	± 0.5%
Resistance to Solder Heat	MIL-STD 202 Method 210	± 0.5%
Dielectric Withstanding Voltage	JIS C 5202 5.6	± 0.5%
Load Life	MIL-STD 202 Method 108	± 1%
Terminal Strength	MIL-STD 202 Method 211	± 0.2%
Moisture Resistance	MIL-STD 202 Method 106	± 0.5%

Operating Temperature Range: -55°C to +155°C

- Features:**
- ✓ Specialized materials, processes and controls ensure a part that is impervious to moisture
 - ✓ Small size with high power density
 - ✓ Auto sequencing / insertion capable
 - ✓ Low cost replacement in many applications using metal glaze resistors
 - ✓ RoHS compliant / lead-free



Electrical Specifications				
Type / Code	Power Rating (Watts) @ 70°C	Maximum Working Voltage ^①	Maximum Pulse Voltage	Ohmic Range and Tolerance
				1%, 2%, 5%
HDM 1/4	0.25W	300V	600V	1Ω - 2.2MΩ
HDM 1/2	0.5W	350V	700V	1Ω - 2.2MΩ

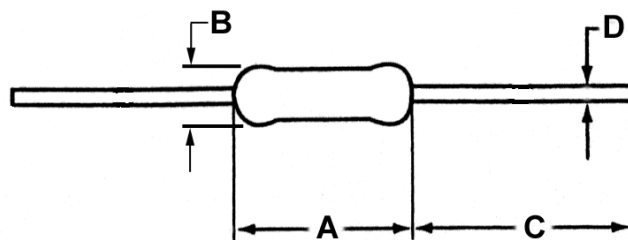

Mechanical Specifications					
Type / Code	A Body Length	B Body Diameter	C Lead Length (Bulk)	D Lead Diameter	Units
HDM 1/4	0.13 ± 0.01/-0	0.07 ± 0.01	1.1 ± 0.12	0.018 ± 0.002	inches
	3.2 ± 0.2/-0	1.8 ± 0.2	28 ± 3	0.45 ± 0.05	mm
HDM 1/2	0.24 ± 0.02	0.09 ± 0.01	1.1 ± 0.12	0.024 ± 0.002	inches
	6 ± 0.3	2.4 ± 0.2	28 ± 3	0.6 ± 0.02	mm

How to Order

SEI Type		Code		Nominal Resistance	Tolerance		Packaging			
HDM		1/2		4.7K	5%		R			
Type	Description	Code	Wattage	Tolerance		Values	Types	Qty	Description	Code
HDM	Moisture Resistant Carbon Film	1/4	0.25W	1% 2% 5%		E24	All	5,000	Tape	R
		1/2	0.5W						Ammo	T
									Bulk	A
							All	1,000	Bulk	A

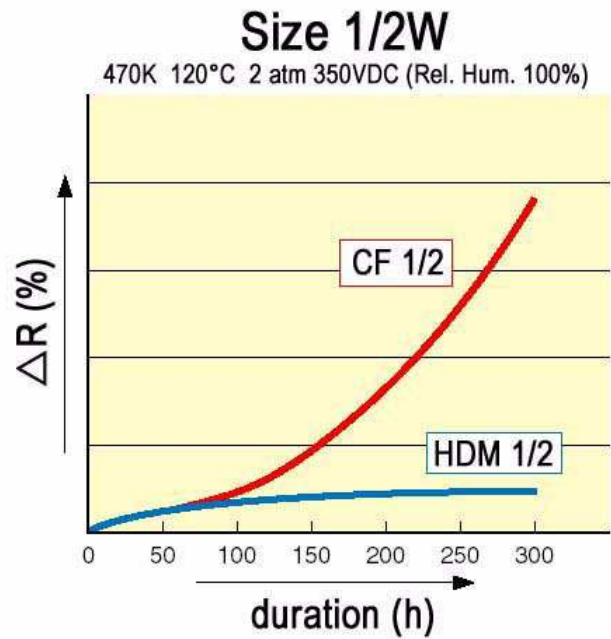
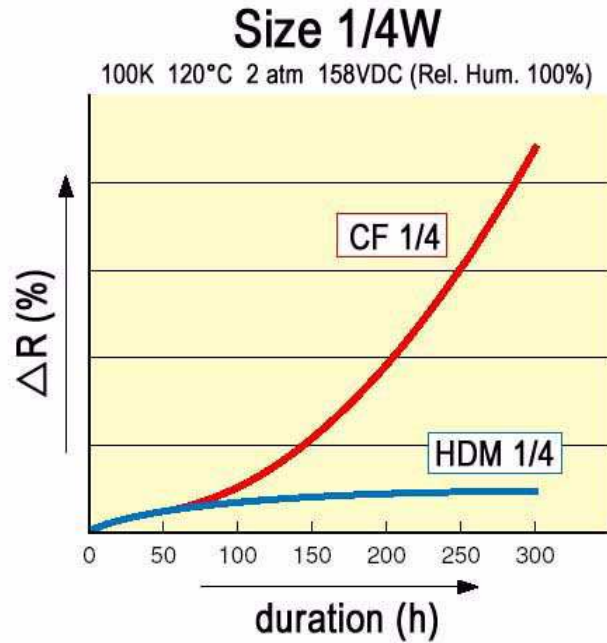

Performance Characteristics		
Test	Standard / Method	Requirement
High temperature, humidity, pressure bias test	120°C, 2atm., >98% R.H., rated DC voltage for 100 hours	±10%
Short time overload	EIA-RS-172-B 3.2.6	±0.75%
Resistance to solder heat	MIL-STD 202, Method 210	±0.5%
Dielectric withstanding voltage	JIS C 5202 5.6	±0.5%
Load life	MIL-STD 202, Method 108	±1%
Temperature cycle	JIS C 5202 7.4	±1%

- Features:
- ✓ Non-inductive design
 - ✓ Molded body for package uniformity
 - ✓ Ideal for pulse-load handling characteristics
 - ✓ Cut and formed product is available on select sizes.
Contact factory for details.
 - ✓ 1W now available
 - ✓ RoHS compliant / lead-free



Electrical Specifications						
Type / Code	Power Rating (Watts) @ 70°C	Maximum Continuous Working Voltage [Ⓞ]	Maximum Pulse Voltage	Dielectric Withstanding Voltage	Ohmic Range and Tolerance	
					10%	5%
RC 1/4	0.25W	250V	400V	500V	1Ω - 5.6MΩ	2.2Ω - 5.6MΩ
RC 1/2	0.5W	350V	700V	700V	1Ω - 22MΩ	1Ω - 22MΩ
RC 1	1W	500V	1,000V	1,000V	2.2Ω - 1MΩ	-

Ⓞ Lesser of \sqrt{PR} or maximum working voltage.

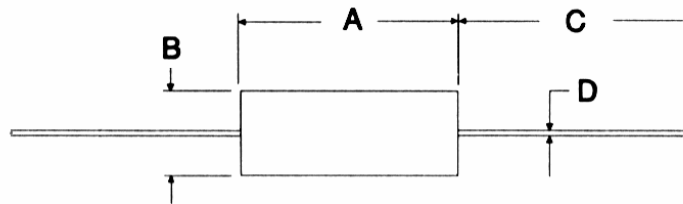

Mechanical Specifications					
Type / Code	A Body Length	B Body Diameter	C Lead Length (Bulk)	D Lead Diameter	Units
RC 1/4	0.248 ± 0.028	0.094 ± 0.004	1.18 ± 0.12	0.0236 ± 0.002	inches
	6.3 ± 0.7	2.4 ± 0.1	30 ± 3	0.6 ± 0.05	mm
RC 1/2	0.374 + 0.031/-0.028	0.142 ± 0.008	1.1 ± 0.12	0.0275 + 0.0028/-0.002	inches
	9.5 + 0.8/-0.7	3.6 ± 0.2	28 ± 3	0.7 + 0.07/-0.05	mm
RC 1	0.56 ± 0.03	0.22 ± 0.01	1.02 ± 0.12	0.04 ± 0.002	inches
	14.3 ± 0.7	5.7 ± 0.3	26 ± 3	0.9 ± 0.05	mm

How to Order

SEI Type		Code		Nominal Resistance		Tolerance		Packaging			
RC		1/2		5.6M		5%		R			
Type	Description	Code	Wattage	Tolerance	Values	Type	Qty	Description	Code		
RC	Carbon Comp	1/4	0.25W	5%	E24	1/4, 1/2	5,000	Tape	R		
		1/2	0.5W	10%		All	1,000	Bulk	A		
		1	1W			All	2,000	Ammo	T		

Resistance Temperature Characteristics			
	Resistance Range	-55°C	+105°C
Maximum % resistance change from room temperature (+25°C) value	Under 1K	+2 to +5	-4 to -2
	1K to 9.1K	+5 to +9	-5 to -3
	10K to 91K	+8 to +11	-7 to -5
	100K to 910K	+10 to +14	-9 to -7
	1M to 10M	+13 to +20	-14 to -9

Performance Characteristics (JISC 5201 – 1:1998)		
Test	Test Results	Test Method
Voltage Proof	No breakdown or flashover	V-block method RC 1/4 100 VAC, 60 seconds RC 1/2 500 VAC, 60 seconds
Overload	±2% +0.05Ω No visible damage, legible markings	2.5 times the rated voltage or twice the limiting element voltage, whichever is less. Severe, 5 seconds.
Termination Strength	Tensile: ±2% +0.05Ω. No visible damage Bending: ±2% +0.05Ω. No visible damage Torsion: ±2% +0.05Ω. No visible damage	10N for 5 - 10 seconds 5N, twice 180°C, two rotations
Solderability	In accordance with Clause 4.17.4.5	235°C, 5 seconds
Resistance to Soldering Heat	±3% +0.05Ω No visible damage, legible markings	After immersion into flux, the immersion into solder shall be carried out 4mm from the body at 350°C for 3.5 seconds
Temperature Shock	±2% +0.05Ω No visible damage.	5 cycles between -55°C to 125°C
Climatic Sequence	±10% +0.5Ω	Dry/Damp heat: 12 + 12 hour cycle, first cycle Cold/Damp heat: 12 + 12 hour cycle, remaining cycle D.C. load
Damp Test, Steady State	±10% +0.5Ω Insulation resistance: R ≥100M ohm. No visible damage, legible markings	40°C 95% relative humidity for 56 days, test a, b and c of Clause 4.24.2.1
Endurance @ 70°C	±10% +0.5Ω Insulation resistance: R ≥1G ohm. No visible damage.	Rated voltage, 1.5 hours ON, 0.5 hours OFF at 70°C, 1,000 hours
Endurance @ 125°C	±10% +0.5Ω Insulation resistance: R ≥1G ohm. No visible damage.	125°C, no load, 1,000 hours

Operating Temperature Range: -55°C to +125°C

Reliability Test – Load Life in Moisture							
Criteria (%)	Load Ratio P/Pn (%)	Total Testing Time (Hrs)	Number of Fractures (pcs)	Failure Ratio		Average Lifetime (60% reliability level) (Hrs)	
				λ	λCL (60%)		
Δ R/R	±5	0	2.984 x 10 ⁶	6	0.201	0.244	4.098 x 10 ⁵
		20	2.990 x 10 ⁶	4	0.134	0.176	5.682 x 10 ⁵
		60	2.997 x 10 ⁶	2	0.067	0.104	9.615 x 10 ⁵
		100	2.992 x 10 ⁶	3	0.1	0.139	7.194 x 10 ⁵
		Total	1.196 x 10 ⁷	15	0.125	0.138	7.209 x 10 ⁵
	±10	Total	1.2 x 10 ⁷	0	0.0055	0.0077	1.299 x 10 ⁷

Technical Guide:

1. Storage Conditions:
 - Temperature: 5 to 35°C (40 to 95°F)
 - Humidity: 25 – 60% relative humidity
 - Term: 2 years in factory poly-bag package (with desiccant)
 - Environment: clean, dry environment, free of corrosive gases
2. Application precautions:
 - Lead forming: forming is recommended at least 2mm of farther from the base of the lead
 - Soldering: soldering is recommended at least 4mm or farther from the base of the lead
3. Washing:

Carbon composition resistors are highly hygroscopic and changes in resistance value can occur if too much moisture is absorbed. For this reason it is recommended not to use water or water-soluble solvents to clean these components. Alcohol or hydrocarbon solvents are recommended for rinsing.

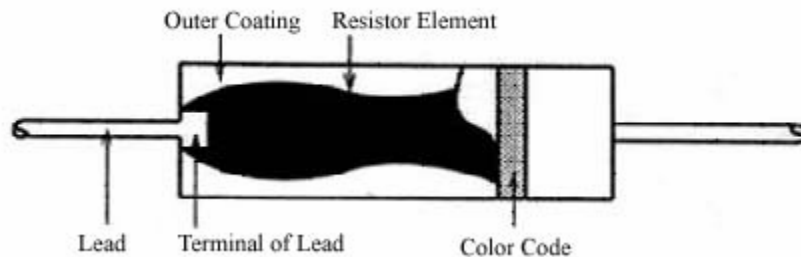

4. Soldering Recommendations:
 - Note: The conditions shown below are for reference. Please perform a mounting evaluation to assure compatibility.
 - a. Flow soldering (recommended profile for Sn and Sn/Pb solders)

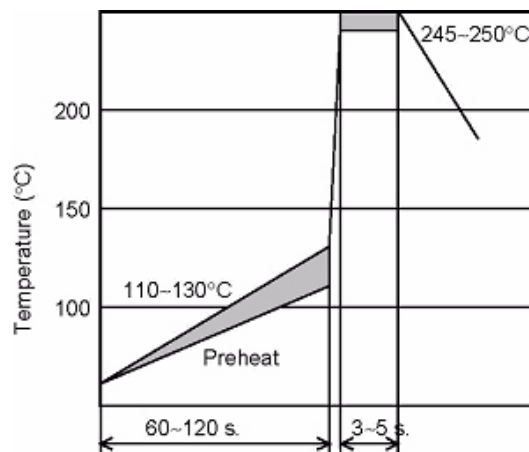

- b. Soldering iron (recommended for Sn and Sn/Pb solders)
 - Temperature of soldering tip: 300°C, duration: 10 sec. max.
 - Temperature of soldering tip: 350°C, duration: 3 sec. max.

Other:

1. Evaluate and confirm the compatibility of your assembly process with this product.
2. Refer to the catalog, the product news, and the specifications for details on the RC series resistors.
3. If you have any questions, please contact our sales staff.

- Features:
- ✓ Ideal for crossovers or jumpers on circuit boards
 - ✓ High current ratings
 - ✓ Standard JW is copper plated steel, with 100% tin overplate
 - ✓ 100% tin plate on copper wire is available as type JWQ
 - ✓ RoHS compliant / lead free

Electrical & Mechanical Specification				
Type	Gauge References	Maximum Current	Diameter	Units
JW 50 R	24	3 Amp	0.02 ± 0.001 0.5 ± 0.02	inches mm
JW 55 R	23	3 Amp	0.022 ± 0.001 0.55 ± 0.03	inches mm
JW 60 R	22	3 Amp	0.024 ± 0.001 0.6 ± 0.03	inches mm
JW 80 R	20	4 Amp	0.031 ± 0.001 0.8 ± 0.05	inches mm

Performance Characteristics	
Coating Thickness	5u ± 2u
Bending	7.1 0.4mm - below 0.6mm - 250g 7.2 0.6mm - below 1 - 500g
Heat Reliability	8.1 Sn 100%: Heat 195°C ± 5°C / 1 hour
Humidity	40°C / 90 - 95RH / 72 hours
Solderability	235°C ± 5°C / 3 seconds

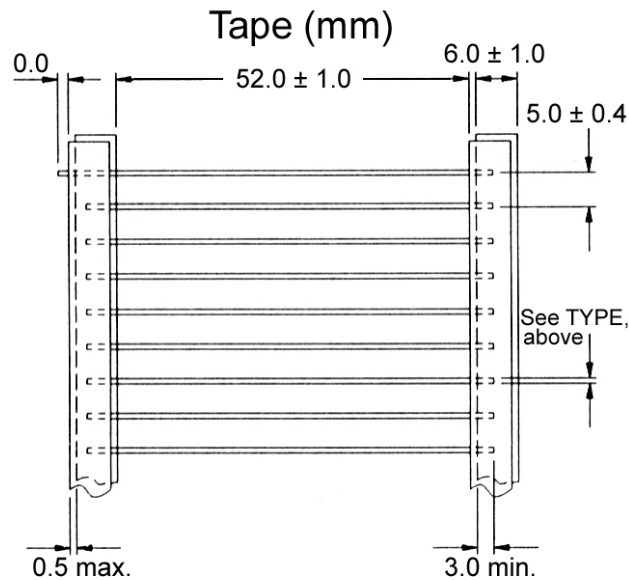

How to Order

SEI Type		Code		Nominal Resistance	Packaging			
JW		50		0	R			
Type	Description	Code	Diameter					
JW	Jumper Wire	50	0.5 mm					
		55	0.55 mm					
		60	0.6 mm					
		80	0.8 mm					
		Types	Qty	Description	Code			
		50, 55, 60	10,000	Reel	R			
		80	8,000					
		50, 55, 60	10,000	Ammo	T			
		80	8,000					

- Features:
- ✓ Ideal for crossovers or jumpers on circuit boards with auto-insertion capability
 - ✓ High current rating
 - ✓ Cut and formed product is available on select sizes, contact factory for details
 - ✓ RoHS compliant / lead-free

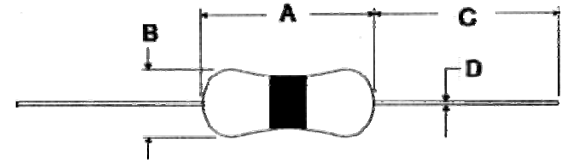

Electrical Specifications				
Part Number	Current Rating (Amps) @ 70°C	Dielectric Withstanding Voltage	Marking	Resistance
CD 1/8 0 R	2A	300V	Single black band	0.01Ω or less
CD 1/4 0 R	3A	500V	Single black band	0.01Ω or less
CD 1/2 0 R	4A	600V	Single black band	0.01Ω or less

Mechanical Specifications					
Type / Code	A Body Length	B Body Diameter	C Lead Length (Bulk)	D Lead Diameter	Units
CD 1/8	0.12 + 0.01/-0.00	0.07 ± 0.01	1.1 ± 0.08	0.018 ± 0.001	inches
	3.2 ± 0.2/-0.0	1.8 ± 0.2	28 ± 2	0.45 ± 0.02	mm
CD 1/4	0.24 ± 0.01	0.09 ± 0.001	1.1 ± 0.08	0.022 ± 0.001	inches
	6 ± 0.3	2.3 ± 0.2	28 ± 2	0.55 ± 0.03	mm
CD 1/2	0.33 + 0.02/-0.00	0.11 ± 0.02	1.1 ± 0.08	0.03 ± 0.001	inches
	8.5 ± 0.5/-0.0	2.7 ± 0.5	28 ± 2	0.7 ± 0.05	mm

How to Order

SEI Type		Code	Nominal Resistance	Packaging			
CD		1/4	0	R			
Type	Description	Code		SEI Type	Qty	Description	Code
CD	CP Wire	1/8		All	5,000	Tape	R
CDQ	Tin Plated Copper	1/4			1,000	Bulk	A
		1/2					

- Features:
- ✓ High temperature molded encapsulation
 - ✓ Flex termination for absorbing thermal expansion
 - ✓ All welded construction
 - ✓ Non-inductive types available as NSM
 - ✓ RoHS compliant / lead-free



Electrical Specifications				
Type / Code	Power Rating (Watts) @ 70°C	Maximum Working Voltage	Resistance Temperature Coefficient	Ohmic Range and Tolerance
				0.1%, 0.5% 1%, 5%
SM 1	1W	25V	±100 ppm/°C ± 20 ppm/°C	0.01Ω - 10Ω ^① 10.2Ω - 1KΩ
SM 2	2W	50V	±100 ppm/°C ± 20 ppm/°C	0.01Ω - 10Ω ^① 10.2Ω - 2KΩ
SM 2A	2W	60V	±75 ppm/°C	0.01Ω - 0.06Ω ^①
SM 3A	3W	60V	±75 ppm/°C	0.01Ω - 0.06Ω ^①
SM 3	3W	100V	±100 ppm/°C ± 20 ppm/°C	0.01Ω - 10Ω ^① 10.2Ω - 3.01KΩ
SM 4	4W	100V	±100 ppm/°C ± 20 ppm/°C	0.01Ω - 10Ω ^① 10.2Ω - 5KΩ

① Zero ohm available on all sizes

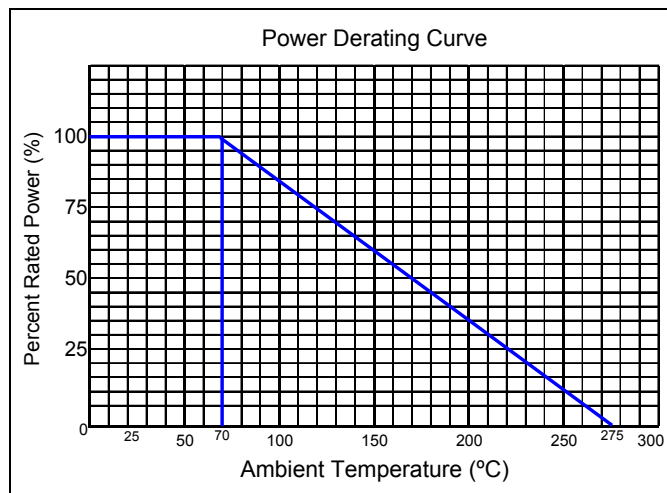

How to Order

SEI Type		Code		Nominal Resistance	Tolerance	Packaging			
SM		2		1K	1%	R			
Type	Description	Code	Size	Tolerance		Types	Qty	Description	Code
SM	Standard	1	2815	0.1%	13" Reel	SM 1	1,500	R	
NSM	Non-inductive	2	4324	0.5%		SM 2	800		
		2A	4827	1%		SM 2A	1,200		
		3A	4827	5%		SM 3, 3A	750		
		3	6528		SM 4	350			
		4	8035						

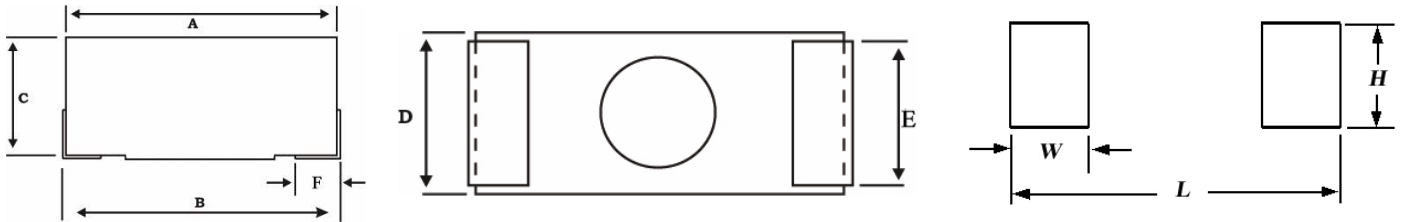

Mechanical Specifications										
Type / Code	A Body Length	B Total Length	C Body Height	D Body Width	E Termination Width	F Termination Length	W	H	L	Units
SM 1	0.26 ± 0.015 6.6 ± 0.4	0.28 ± 0.032 7.1 ± 0.81	0.14 ± 0.015 3.6 ± 0.4	0.15 ± 0.015 3.8 ± 0.4	0.1 ± 0.015 2.5 ± 0.4	0.09 ± 0.015 2.3 ± 0.4	0.138 3.5	0.13 3.3	0.35 8.9	inches mm
SM 2	0.41 ± 0.015 10.4 ± 0.4	0.43 ± 0.032 10.9 ± 0.81	0.18 ± 0.015 4.6 ± 0.4	0.24 ± 0.015 6.1 ± 0.4	0.122 ± 0.015 3.1 ± 0.4	0.09 ± 0.015 2.3 ± 0.4	0.181 4.6	0.157 4	0.583 14.8	inches mm
SM 2A	0.455 ± 0.015 11.6 ± 0.4	0.475 ± 0.032 12.1 ± 0.81	0.15 ± 0.015 3.8 ± 0.4	0.27 ± 0.015 6.9 ± 0.4	0.122 ± 0.015 3.1 ± 0.4	0.105 ± 0.015 2.7 ± 0.4	0.169 4.3	0.157 4	0.587 14.9	inches mm
SM 3A	0.455 ± 0.015 11.6 ± 0.4	0.475 ± 0.032 12.1 ± 0.81	0.15 ± 0.015 3.8 ± 0.4	0.27 ± 0.015 6.9 ± 0.4	0.122 ± 0.015 3.1 ± 0.4	0.105 ± 0.015 2.7 ± 0.4	0.169 4.3	0.157 4	0.587 14.9	inches mm
SM 3	0.625 ± 0.015 15.9 ± 0.4	0.645 ± 0.032 16.4 ± 0.81	0.25 ± 0.015 6.4 ± 0.4	0.275 ± 0.015 7 ± 0.4	0.122 ± 0.015 3.1 ± 0.4	0.13 ± 0.015 3.3 ± 0.4	0.236 6.2	0.165 4.2	0.85 21.6	inches mm
SM 4	0.8 ± 0.015 20.3 ± 0.4	0.825 ± 0.032 21 ± 0.81	0.362 ± 0.015 9.2 ± 0.4	0.35 ± 0.015 8.9 ± 0.4	0.24 ± 0.015 6.1 ± 0.4	0.123 ± 0.015 3.1 ± 0.4	0.34 8.6	0.19 4.8	0.95 24.1	inches mm

Performance Characteristics	
Test	Results
Moisture Resistance	±1%
Thermal Shock	±0.5%
Load Life @ 70°C - 1,000 hrs.	±1%
Shock and Vibration	±1%
Resistance to Soldering Heat	±1
Terminal Strength	±0.5%
Dielectric Withstanding Voltage	±0.001% / V
Short Time Overload	±0.2%
Low Temperature Operation	±0.5%

Operating Temperature Range: -55°C to +275°C

- Features:**
- ✓ WWS offers miniature size at higher power rating
 - ✓ High performance for low cost
 - ✓ High power to size ratio
 - ✓ MWW – Completely molded construction with welded terminations tested to MIL-R-39007
 - ✓ Complete welded terminations
 - ✓ Tinned copper leads
 - ✓ Available in non-inductive styles
 - ✓ High temperature silicone coating
 - ✓ RoHS compliant / lead-free



Electrical Specifications						
Type / Code	MIL-R-26 Ref.	Dielectric Strength (V)	Power Rating (Watts)		Ohmic Range and Tolerance [ⓐ]	
			@ 125°C (U)	@ 25°C (V)	0.1%, 0.5%, 1% & 5%	
					Standard	Non-Inductive
WW H	-	500V	0.4W	0.6W	0.1Ω - 2KΩ	0.1Ω - 1KΩ
WW 1 / WWS 2	-	500V	1W	1.2W	0.1Ω - 3KΩ	0.1Ω - 1.5KΩ
WW 1A	RW-70	500V	1W	1.5W	0.1Ω - 7KΩ	0.1Ω - 3.5KΩ
WW 2 / WWS 3	RW-69	1,000V	1.5W	2.5W	0.1Ω - 10KΩ	0.1Ω - 5KΩ
WW 2A	-	1,000V	2.5W	3W	0.1Ω - 15KΩ	0.1Ω - 7.5KΩ
WW 3 / WWS 4	RW-79	1,000V	3W	3.7W	0.1Ω - 22KΩ	0.1Ω - 11KΩ
WW 3A	-	1,000V	3W	4W	0.1Ω - 30KΩ	0.1Ω - 15KΩ
WW 4 / WWS 5	-	1,000V	4W	5W	0.1Ω - 40KΩ	0.1Ω - 20KΩ
WW 5 / WWS 7	RW-67, RW-74	1,000V	5W	6W	0.1Ω - 50KΩ	0.1Ω - 25KΩ
WW 7	-	1,000V	6.5W	8.5W	0.1Ω - 70KΩ	0.1Ω - 35KΩ
WW 7B / WWS 10	-	1,000V	7W	9W	0.1Ω - 100KΩ	0.1Ω - 50KΩ
WW 10	RW-78	1,000V	10W	13W	0.1Ω - 150KΩ	0.1Ω - 75KΩ
MWW 1	RW-70	1,000V	1W	1.5W	0.1Ω - 2KΩ	-
MWW 3	RW-79	1,000V	3W	3.75W	0.1Ω - 20KΩ	-
MWW 5	RW-67, RW-74	1,000V	5W	6.5W	0.1Ω - 40KΩ	-
MWW 10	RW-68, RW-74	1,000V	10W	13W	0.1Ω - 150KΩ	-

[ⓐ]Lesser of √PR or maximum working voltage

How to Order

SEI Type		Code	Nominal Resistance	Tolerance	Packaging			
WW		1	10K	1%	R			
Type	Description	Code		Tolerance	Types	Qty	Description	Code
WW	Standard	1	4	0.1%	WW H, WW 1, WW 1A, MWW 1	2,500	11" Flange	R
WWS	Mini	1A	5	0.5%	WW 2, WW 2A, WW 3, WW 4, MWW 3	2,000		
MWW	Molded	2	7	1%	WW 3A	5,000		
NWW	Non-Inductive	2A	7B	5%	WW 5, WW 7, WW 7B, WW 10, MWW 5	500		
		3	10		WW 10, MWW 10	250		
		3A	H					

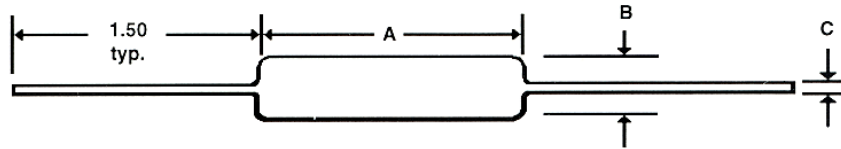

Mechanical Specifications				
Type / Code	A	B	C	Units
WW H	0.312 ± 0.062 7.9 ± 1.6	0.11 ± 0.031 2.8 ± 0.8	0.0245 ± 0.002 0.64 ± 0.05	inches mm
WW 1 / WWS 2	0.375 ± 0.062 9.5 ± 1.6	0.11 ± 0.031 2.8 ± 0.8	0.025 ± 0.002 0.64 ± 0.05	inches mm
WW 1 A	0.42 ± 0.062 10.7 ± 1.6	0.11 ± 0.031 2.8 ± 0.8	0.025 ± 0.002 0.64 ± 0.05	inches mm
WW 2 / WWS 3	0.37 ± 0.062 9.4 ± 1.6	0.156 ± 0.031 4 ± 0.8	0.032 ± 0.002 0.81 ± 0.05	inches mm
WW 2A	0.55 ± 0.062 14 ± 1.6	0.156 ± 0.031 4 ± 0.8	0.032 ± 0.002 0.81 ± 0.05	inches mm
WW 3 / WWS 4	0.56 ± 0.062 14.2 ± 1.6	0.187 ± 0.031 4.8 ± 0.8	0.032 ± 0.002 0.81 ± 0.05	inches mm
WW 3A	0.5 ± 0.062 12.7 ± 1.6	0.218 ± 0.031 5.5 ± 0.8	0.032 ± 0.002 0.81 ± 0.05	inches mm
WW 4 / WWS 5	0.7 ± 0.062 17.8 ± 1.6	0.27 ± 0.031 6.9 ± 0.8	0.036 ± 0.002 0.91 ± 0.05	inches mm
WW 5 / WWS 7	0.875 ± 0.062 22.2 ± 1.6	0.312 ± 0.031 7.9 ± 0.8	0.036 ± 0.002 0.91 ± 0.05	inches mm
WW 7	1 ± 0.062 25.4 ± 1.6	0.312 ± 0.031 7.9 ± 0.8	0.036 ± 0.002 0.91 ± 0.05	inches mm
WW 7B / WWS 10	1.2 ± 0.062 30.5 ± 1.6	0.312 ± 0.031 7.9 ± 0.8	0.036 ± 0.002 0.91 ± 0.05	inches mm
WW 10	1.78 ± 0.062 45.2 ± 1.6	0.375 ± 0.031 9.5 ± 0.8	0.036 ± 0.002 [ⓐ] 0.91 ± 0.05j	inches mm
MWW 1	0.385 ± 0.062 9.8 ± 1.6	0.135 ± 0.031 3.4 ± 0.8	0.032 ± 0.002 0.81 ± 0.05	inches mm
MWW 3	0.56 ± 0.062 14.2 ± 1.6	0.205 ± 0.031 5.2 ± 0.8	0.032 ± 0.002 0.81 ± 0.05	inches mm
MWW 5	0.925 ± 0.062 23.5 ± 1.6	0.33 ± 0.031 8.4 ± 0.8	0.036 ± 0.002 0.91 ± 0.05	inches mm
MWW 10	1.965 ± 0.062 49.9 ± 1.6	0.48 ± 0.031 12.2 ± 0.8	0.04 ± 0.002 1.02 ± 0.05	inches mm

ⓐ Available in 0.04

Performance Characteristics	
Test	Results
Moisture Resistance	1% max
Load Life	1%
Temperature Cycling	0.5%
Short Time Overload	1%

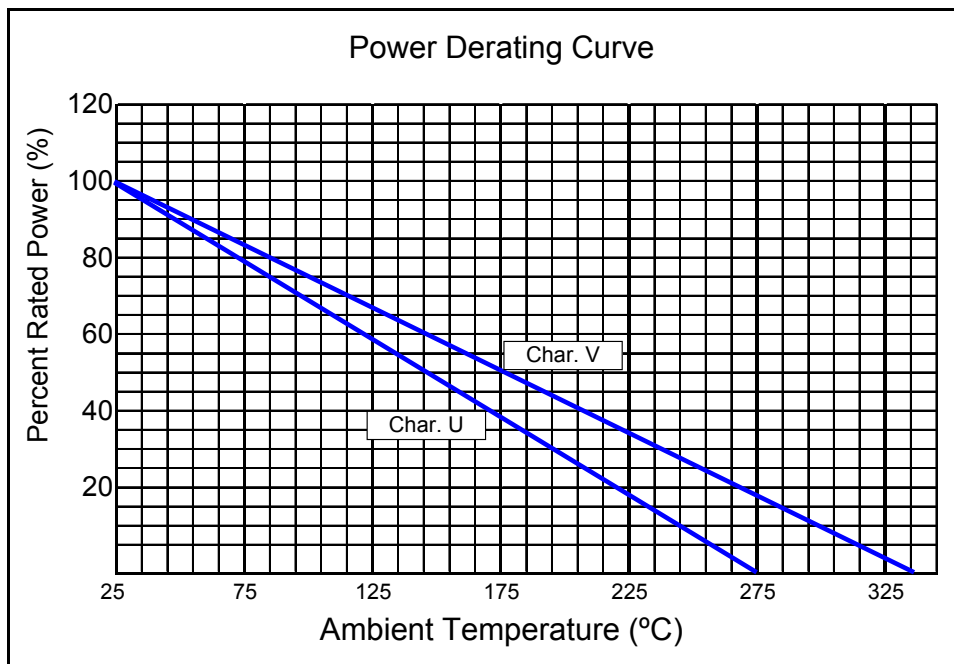

Characteristic "U" -55°C to +275°C
Characteristic "V" -55°C to +350°C

- Features:**
- ✓ Conformal coating
 - ✓ Flameproof construction
 - ✓ Cut and formed product is available on select sizes
Contact factory for details
 - ✓ RoHS compliant / lead-free

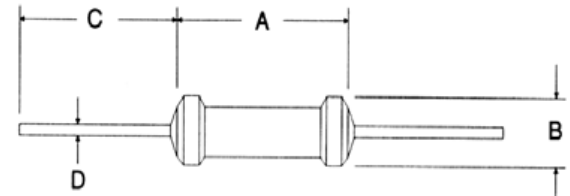

Electrical Specifications					
Type / Code	Power Rating (Watts) @ 25°C	Maximum Working Voltage	Dielectric Withstanding Voltage (RMS)	Resistance Temperature Coefficient	Ohmic Range and Tolerance
					5%
WRF 1	1W	\sqrt{PR}	700V	-80 ppm/°C ~ +900 ppm/°C	0.1Ω - 33Ω
WRF 2	2W	\sqrt{PR}	700V	-80 ppm/°C ~ +900 ppm/°C	0.1Ω - 220Ω
WRF 3	3W	\sqrt{PR}	700V	-80 ppm/°C ~ +900 ppm/°C	0.1Ω - 220Ω

Mechanical Specifications					
Type / Code	A Body Length	B Body Width	C Lead Length (Bulk)	D Lead Diameter	Units
WRF 1	0.433 max 11 max	0.197 max 5 max	1.1 ± 0.08 28 ± 3	0.031 ± 0.002 0.78 ± 0.05	inches mm
WRF 2	0.630 max 16 max	0.197 max 5 max	1.1 ± 0.08 28 ± 3	0.031 ± 0.002 0.78 ± 0.05	inches mm
WRF 3	0.630 max 16 max	0.197 max 5 max	1.1 ± 0.12 28 ± 3	0.031 ± 0.002 0.78 ± 0.05	inches mm

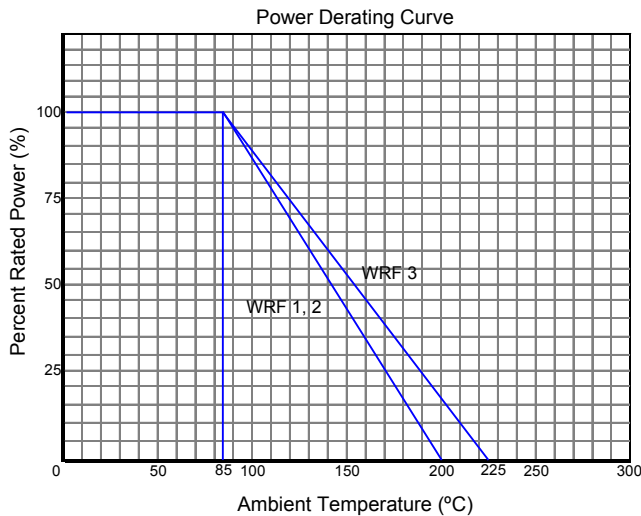

Performance Characteristics	
Test	Test Results
Rated Ambient Temperature	85°C
Overload 15 Times the Rated Wattage	Open circuit within 2 minutes
Short Time Overload	± 3% + 0.05Ω
Effective Soldering	± 2% + 0.05Ω
Insulation Resistance	>10 ⁴ MΩ
Dielectric Withstanding Volt	± 2% + 0.05Ω
Load Life @ 70°C - 1,000 hrs.	± 5% + 0.05Ω
Moisture Resistance	± 5% + 0.05Ω
Shock and Vibration	± 1% + 0.05Ω
Solderability	90% tin covered min.
Temperature Coefficient	-80 ± 900 ppm/°C

Operating Temperature Range: -55°C to +200°C (WRF 1, 2)
-55°C to +220°C (WRF 3)

How to Order

SEI Type		Code	Nominal Resistance	Tolerance	Packaging				
WRF		2	1.1K	5%	A				
Type	Description	Code		Tolerance	Values	Type	Pkg Qty	Description	Code
WRF	Conformal Coated WW	1		5%	E24	All	1,000	Bulk	A
		2				All	2,000	Tape	R
		3							

CB Series

Ceramic Housed Wirewound with Axial Leads

Stackpole Electronics, Inc.

Resistive Product Solutions

- Features:
- ✓ Fireproof power wirewound
 - ✓ High thermal conductivity
 - ✓ Different element(resistor) available: precision / ceramic & metal oxide
 - ✓ Non-inductive styles available
 - ✓ Body standoffs available; add "F" after CB
 - ✓ RoHS compliant / lead-free

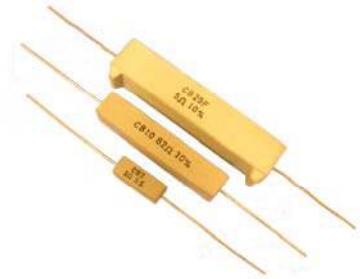

Electrical Specifications					
Type / Code	Power Rating (Watts) @ 70°C	Ohmic Range and Tolerance			
		0.5%	1%	5%	10%
CB 2	2W	-	-	0.1Ω - 300Ω	0.1Ω - 300Ω
CB 3	3W	-	-	0.1Ω - 680Ω	0.1Ω - 680Ω
CB 5	5W	-	-	0.1Ω - 680Ω	0.1Ω - 680Ω
CB 7	7W	-	-	0.1Ω - 1.5KΩ	0.1Ω - 1.5KΩ
CB 10	10W	-	-	0.1Ω - 2KΩ	0.1Ω - 2KΩ
CB 15	15W	-	-	0.15Ω - 2KΩ	0.15Ω - 2KΩ
CB 20	20W	-	-	0.2Ω - 2KΩ	0.2Ω - 2KΩ
CB 22	22W	-	-	1Ω - 250Ω	1Ω - 250Ω
CB 25	25W	-	-	0.2Ω - 2KΩ	0.2Ω - 2KΩ
CB 30	30W	-	-	1Ω - 250Ω	1Ω - 250Ω
WCB 2	2W	1Ω - 5KΩ	1Ω - 5KΩ	1Ω - 5KΩ	-
WCB 3	3W	1Ω - 10KΩ	1Ω - 10KΩ	1Ω - 10KΩ	-
WCB 5	5W	1Ω - 10KΩ	1Ω - 10KΩ	1Ω - 10KΩ	-
WCB 7	7W	1Ω - 15KΩ	1Ω - 15KΩ	1Ω - 15KΩ	-
WCB 10	10W	1Ω - 20KΩ	1Ω - 20KΩ	1Ω - 20KΩ	-
WCB 15	15W	1Ω - 20KΩ	1Ω - 20KΩ	1Ω - 20KΩ	-
MCB 3	3W	-	-	1Ω - 500KΩ	-
MCB 5	5W	-	-	1Ω - 500KΩ	-
MCB 7	7W	-	-	1Ω - 500KΩ	-

Resistance Temperature Coefficient Standard:

CB series: ±800ppm below 1Ω & ±300ppm for 1Ω and above;

WCB series: ±50ppm from 1Ω to 10Ω & ±20ppm above 10Ω;

MCB series: ±200ppm

How to Order

SEI Type		Code	Nominal Resistance	Tolerance	Packaging			
CB		1/2	100	5%	R			
Code	Description	Code		Tolerance	SEI Types	Pkg Qty	Description	Code
CB	Standard	2	3	1%	CB 2, CB 3, CB 5, MCB 3, MCB 5	750	Bulk	B
WCB		5	7	1%	WCB 2, WCB 3, WCB 5	500		
MCB		10	15	5%	CB 7, CB 10, CB 15, WCB 7, WCB 10, WCB 15, MCB 7	250		
CBF	20	22	10%	CB 20, CB 22, CB 25, CB 30	100			
WCBF	With standoff	25	30					
MCBF								
NWCB	Non inductive							
NWCBF	Non inductive with standoff							

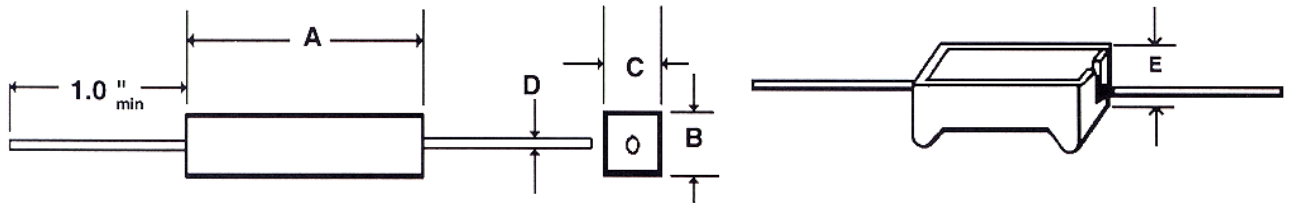

Mechanical Specifications						
Type / Code	A	B	C	D	E	Units
Tolerance	±0.039	±0.039	±0.039	±0.002	±0.031	inches
	±1	±1	±1	±0.05	±0.8	mm
CB 2	0.709	0.276	0.276	0.025	0.300	inches
	18.0	7.0	7.0	0.7	7.6	mm
CB 3	0.866	0.312	0.312	0.032	0.375	inches
	22.0	8.0	8.0	0.8	9.5	mm
CB 5	0.866	0.394	0.394	0.032	0.437	inches
	22.0	10.0	10.0	0.8	11.1	mm
CB 7	1.378	0.394	0.394	0.032	0.500	inches
	35.0	10.0	10.0	0.8	12.7	mm
CB 10	1.890	0.394	0.394	0.032	0.500	inches
	48.0	10.0	10.0	0.8	12.7	mm
CB 15	1.890	0.492	0.492	0.032	0.625	inches
	48.0	12.5	12.5	0.8	15.9	mm
CB 20	2.362	0.571	0.531	0.032	0.625	inches
	60.0	14.5	13.5	0.8	15.9	mm
CB 22	2.500	0.500	0.500	0.036	0.625	inches
	63.5	12.7	12.7	0.9	15.9	mm
CB 25	2.362	0.571	0.531	0.032	0.625	inches
	60.0	14.5	13.5	0.8	15.9	mm
CB 30	2.500	0.625	0.625	0.036	-	inches
	63.5	15.9	15.9	0.9		mm
WCB 2	0.700	0.245	0.255	0.032	0.300	inches
	17.8	6.2	6.5	0.8	7.6	mm
WCB 3 / MCB 3	0.875	0.312	0.312	0.032	0.375	inches
	22.2	7.9	7.9	0.8	9.5	mm
WCB 5 / MCB 5	0.875	0.375	0.375	0.032	0.437	inches
	22.2	9.5	9.5	0.8	11.1	mm
WCB 7 / MCB 7	1.400	0.375	0.375	0.036	0.500	inches
	35.6	9.5	9.5	0.9	12.7	mm
WCB 10	1.875	0.375	0.375	0.036	0.500	inches
	47.6	9.5	9.5	0.9	12.7	mm
WCB 15	1.875	0.500	0.500	0.036	0.625	inches
	47.6	12.7	12.7	0.9	15.9	mm

Performance Characteristics	
Test	Test Results
Moisture Resistance	± 5%
Thermal Shock	± 2%
Load Life @ 70°C - 1,000 hrs.	± 5%
Resistance to Soldering Heat	± 2%
Short Time Overload - 5xPn for 5sec	± 2%
Dielectric Withstanding Voltage	± 2%

Operating Temperature Range: -55°C to +275°C

LCB Series

Ceramic Housed for Current Sensing – 2 Leads

Stackpole Electronics, Inc.

Resistive Product Solutions

- Features:
- ✓ Fireproof construction
 - ✓ Low temperature coefficient
 - ✓ Low resistance value ceramic encased resistor
 - ✓ All welded termination
 - ✓ RoHS compliant / lead-free



See CB datasheet for performance and environmental specifications

Electrical Specifications			
Type / Code	Power Rating (Watts) @ 70°C	Resistance Temperature Coefficient ^①	Ohmic Range and Tolerance
			1%, 5%, 10%
LCB 3	3W	±50 to ±400 ppm/°C	0.005Ω - 0.1Ω
LCB 5	5W	±50 to ±400 ppm/°C	0.005Ω - 0.1Ω
LCB 7	7W	±50 to ±400 ppm/°C	0.01Ω - 0.15Ω
LCB 10	10W	±50 to ±400 ppm/°C	0.01Ω - 0.2Ω
LCB 15	15W	±50 to ±400 ppm/°C	0.01Ω - 0.2Ω

① TCR is value dependent. Please contact factory for specific data.

Alternate Configuration Series LCBF

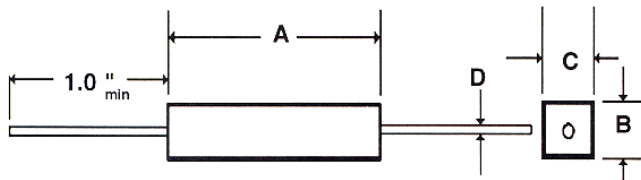

Resistance measured 3/8" from the body

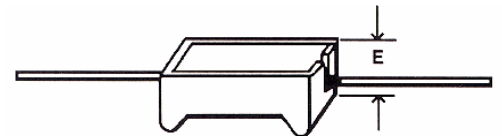

Mechanical Specifications						
Type / Code	A	B	C	D	E	Units
LCB 3	0.875 ± 0.031 22.2 ± 0.8	0.312 ± 0.031 7.9 ± 0.8	0.312 ± 0.031 7.9 ± 0.8	0.032 ± 0.031 0.81 ± 0.8	0.375 ± 0.031 9.5 ± 0.8	inches mm
LCB 5	0.875 ± 0.031 22.2 ± 0.8	0.375 ± 0.031 9.5 ± 0.8	0.375 ± 0.031 9.5 ± 0.8	0.032 ± 0.031 0.81 ± 0.8	0.437 ± 0.031 11.1 ± 0.8	inches mm
LCB 7	1.4 ± 0.031 35.6 ± 0.8	0.375 ± 0.031 9.5 ± 0.8	0.375 ± 0.031 9.5 ± 0.8	0.036 ± 0.031 0.91 ± 0.8	0.5 ± 0.031 12.7 ± 0.8	inches mm
LCB 10	1.875 ± 0.031 47.6 ± 0.8	0.375 ± 0.031 9.5 ± 0.8	0.375 ± 0.031 9.5 ± 0.8	0.036 ± 0.031 0.91 ± 0.8	0.5 ± 0.031 12.7 ± 0.8	inches mm
LCB 15	1.875 ± 0.031 47.6 ± 0.8	0.5 ± 0.031 12.7 ± 0.8	0.5 ± 0.031 12.7 ± 0.8	0.036 ± 0.031 0.91 ± 0.8	0.625 ± 0.031 15.9 ± 0.8	inches mm

How to Order

SEI Type		Code		Nominal Resistance	Tolerance	Packaging								
LCB		3		0.1	5%	B								
Type	Description	Code	Wattage	<table border="1"> <thead> <tr> <th>Tolerance</th> </tr> </thead> <tbody> <tr> <td>1%</td> </tr> <tr> <td>5%</td> </tr> <tr> <td>10%</td> </tr> </tbody> </table>		Tolerance	1%	5%	10%	Types		Qty	Description	Code
Tolerance														
1%														
5%														
10%														
LCB	Standard	3	3W	LCB 3, LCB 5		750	Bulk	B						
LCBF	With Standoff	5	5W	LCB 7, LCB 10, LCB 15		250								
		7	7W											
		10	10W											
		15	15W											

TCB Series

Ceramic Housed for Current Sensing – 4 Leads

Stackpole Electronics, Inc.

Resistive Product Solutions

- Features:
- ✓ Four terminal construction
 - ✓ Low inductance
 - ✓ Low temperature coefficient
 - ✓ RoHS compliant / lead-free
 - ✓ Fireproof construction
 - ✓ All welded termination
 - ✓ Low resistance value ceramic encased resistor
- See CB data sheet for performance and environmental specifications

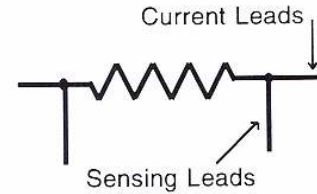
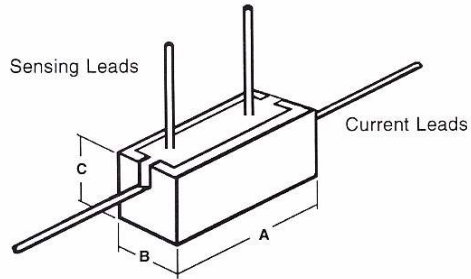
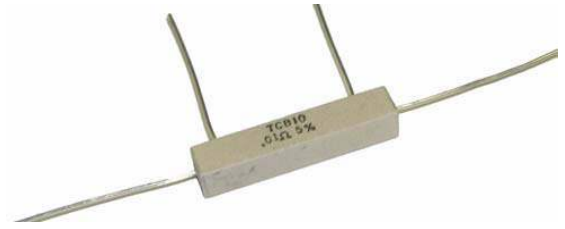

Lead Diameter .036 Length 1" minimum

Electrical Specifications

Type / Code	Power Rating (Watts) @ 70°C	Resistance Temperature Coefficient	Ohmic Range and Tolerance	
			1%	5%
TCB 3	3W	±40 ppm/°C	0.005Ω - 0.1Ω	0.005Ω - 0.1Ω
TCB 5	5W	±40 ppm/°C	0.005Ω - 0.1Ω	0.005Ω - 0.1Ω
TCB 7	7W	±40 ppm/°C	0.01Ω - 0.15Ω	0.01Ω - 0.15Ω
TCB 10	10W	±40 ppm/°C	0.01Ω - 0.2Ω	0.01Ω - 0.2Ω
TCB 15	15W	±40 ppm/°C	0.01Ω - 0.2Ω	0.01Ω - 0.2Ω

Mechanical Specifications

Type / Code	A Body Length (max)	B Body Width	C Body Height (Bulk)	Sensing Lead Spacing	Units
TCB 3	0.875 ± 0.031	0.312 ± 0.031	0.312 ± 0.031	0.563 ± 0.062	inches
	22.2 ± 0.8	7.9 ± 0.8	7.9 ± 0.8	14.3 ± 1.6	mm
TCB 5	0.875 ± 0.031	0.375 ± 0.031	0.375 ± 0.031	0.563 ± 0.062	inches
	22.2 ± 0.8	9.5 ± 0.8	9.5 ± 0.8	14.3 ± 1.6	mm
TCB 7	1.4 ± 0.031	0.375 ± 0.031	0.375 ± 0.031	1 ± 0.062	inches
	35.6 ± 0.8	9.5 ± 0.8	9.5 ± 0.8	25.4 ± 1.6	mm
TCB 10	1.875 ± 0.031	0.375 ± 0.031	0.375 ± 0.031	1.375 ± 0.062	inches
	47.6 ± 0.8	9.5 ± 0.8	9.5 ± 0.8	34.9 ± 1.6	mm
TCB 15	1.875 ± 0.031	0.5 ± 0.031	0.5 ± 0.031	1.375 ± 0.062	inches
	47.6 ± 0.8	12.7 ± 0.8	12.7 ± 0.8	34.9 ± 1.6	mm

How to Order

SEI Type		Code		Nominal Resistance	Tolerance	Packaging			
TCB		3		0.1	5%	B			
Type	Description	Code	Wattage			Types	Qty	Description	Code
TCB	4 - Leads	3	3W			All	50	Bulk	B
		5	5W						
		7	7W						
		10	10W						
		15	15W						
				Tolerance					
				1%					
				5%					

- Features:**
- ✓ Flameproof inorganic construction
 - ✓ High temperature potting compound
 - ✓ VM – Wirewound on fiberglass element
 - ✓ MVM – Metal oxide element for higher values
 - ✓ LVM – Low resistance wire or ribbon element
 - ✓ WVM – Precision wirewound element
 - ✓ RoHS compliant / lead-free
 - ✓ See CB Series for Performance Characteristics



Electrical Specifications						
Type / Code	Power Rating (Watts) @ 70°C	Ohmic Range and Tolerance				
		Voltage Rating	0.5%	1%	5%	10%
VM 2	2W	-	-	-	0.1Ω - 100Ω	0.1Ω - 100Ω
VM 3	3W	-	-	-	0.1Ω - 125Ω	0.1Ω - 125Ω
VM 5	5W	-	-	-	0.1Ω - 150Ω	0.1Ω - 150Ω
VM 7	7W	-	-	-	0.2Ω - 300Ω	0.2Ω - 300Ω
VM 10	10W	-	-	-	0.2Ω - 300Ω	0.2Ω - 300Ω
MVM 3	3W	250V	-	-	100Ω - 1KΩ	100Ω - 100KΩ
MVM 5	5W	350V	-	-	100Ω - 1KΩ	100Ω - 100KΩ
LVM 2	2W	-	-	0.01Ω - 0.1Ω	0.01Ω - 0.1Ω	0.01Ω - 0.1Ω
LVM 3	3W	-	-	0.01Ω - 0.1Ω	0.01Ω - 0.1Ω	0.01Ω - 0.1Ω
LVM 5	5W	-	-	0.01Ω - 0.1Ω	0.01Ω - 0.1Ω	0.01Ω - 0.1Ω
LVM 7	7W	-	-	0.02Ω - 0.15Ω	0.02Ω - 0.15Ω	0.02Ω - 0.15Ω
LVM 10	10W	-	-	0.02Ω - 0.15Ω	0.02Ω - 0.15Ω	0.02Ω - 0.15Ω
WVM 2	2W	-	0.1Ω - 2KΩ	0.1Ω - 2KΩ	0.1Ω - 2KΩ	-
WVM 3	3W	-	0.1Ω - 5KΩ	0.1Ω - 5KΩ	0.1Ω - 5KΩ	-
WVM 5	5W	-	0.1Ω - 5KΩ	0.1Ω - 5KΩ	0.1Ω - 5KΩ	-
WVM 7	7W	-	0.1Ω - 8KΩ	0.1Ω - 8KΩ	0.1Ω - 8KΩ	-
WVM 10	10W	-	0.1Ω - 8KΩ	0.1Ω - 8KΩ	0.1Ω - 8KΩ	-

Maximum Working Voltage is limited by \sqrt{PR}
Resistance Temperature Coefficient Standard

VM Series: ±800ppm below 1Ω & ±300ppm at 1Ω and above
MVM Series: ±200ppm
LVM Series: ±50 to ±400ppm depending on value
WVM Series: ±90ppm below 1Ω, ±50ppm from 1Ω to 10Ω & ±20ppm above 10Ω

How to Order

SEI Type		Code	Nominal Resistance	Tolerance	Packaging			
VM		3	2.2	5%	B			
Type	Description	Code			Types	Qty	Description	Code
VM	Standard WW	2			VM 2, VM 3, VM 5 MVM	750	Bulk	B
MVM	Metal Oxide	3			VM 7, VM 10	250		
LVM	Ribbon Element	5			LVM, WVM	500		
WVM	Precision WW	7						
NWVM	Non-inductive WW	10						
				Tolerance				
				0.5%				
				1%				
				5%				
				10%				

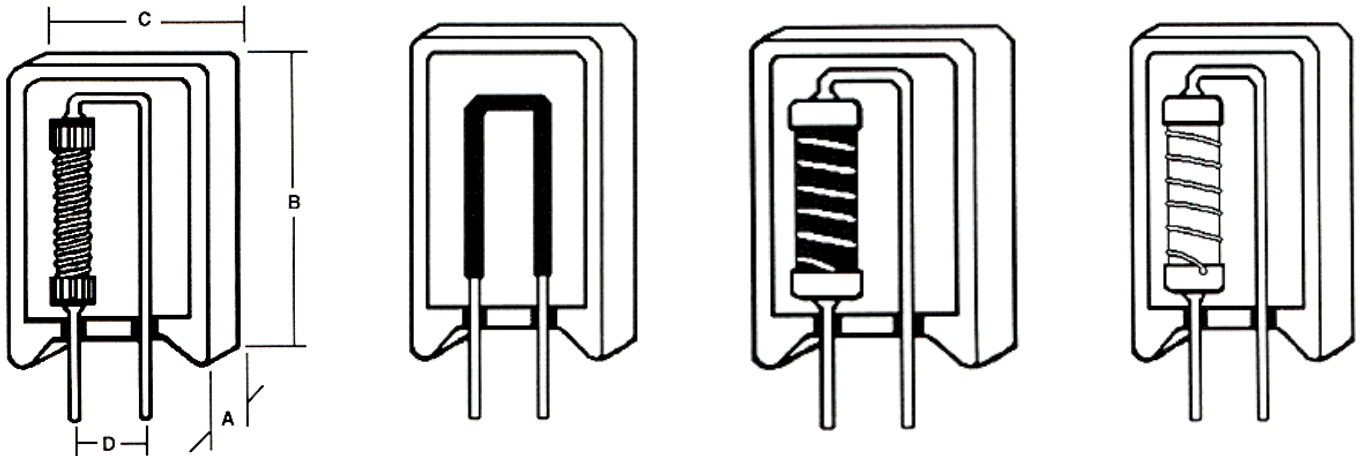

VM 2 lead diameter is 0.032 and MVM, LVM & WVM lead diameter is 0.036.
Series VM, MVM, LVM & WVM have the same dimensions.

Mechanical Specification					
Type / Code	A	B	C	D	Units
VM 2	0.28 ± 0.039 7.1 ± 1	0.82 ± 0.059 20.8 ± 1.5	0.435 ± 0.039 11 ± 1	0.2 ± 0.059 5.1 ± 1.5	inches mm
VM 3	0.38 ± 0.039 9.7 ± 1	0.975 ± 0.059 24.8 ± 1.5	0.475 ± 0.039 12.1 ± 1	0.2 ± 0.059 5.1 ± 1.5	inches mm
VM 5	0.38 ± 0.039 9.7 ± 1	0.99 ± 0.059 25.1 ± 1.5	0.52 ± 0.039 13.2 ± 1	0.2 ± 0.059 5.1 ± 1.5	inches mm
VM 7	0.38 ± 0.039 9.7 ± 1	1.52 ± 0.059 38.6 ± 1.5	0.52 ± 0.039 13.2 ± 1	0.2 ± 0.059 5.1 ± 1.5	inches mm
VM 10	0.48 ± 0.039 12.2 ± 1	1.375 ± 0.059 34.9 ± 1.5	0.635 ± 0.039 16.1 ± 1	0.3 ± 0.059 7.6 ± 1.5	inches mm

VM lead length 0.175 ± 0.032 and lead diameter 0.032

MVM lead length 0.175 ± 0.032 and lead diameter 0.032

LVM lead length 0.175 ± 0.032 and LVM 2 to LVM 5 lead diameter 0.032 & LVM 7 to LVM 10 lead diameter 0.036

WVM lead length 0.175 ± 0.032 and WVM 2 to WVM 5 lead diameter 0.032 & WVM 7 to WVM 10 lead diameter 0.036

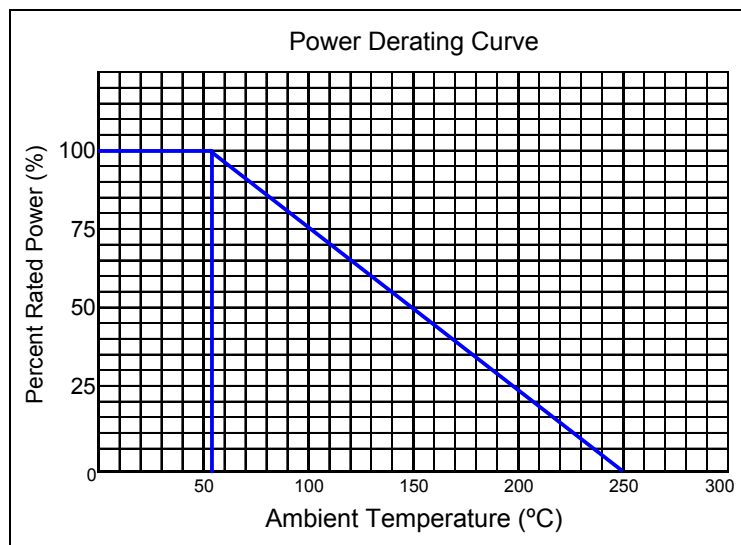

- Features:
- ✓ Good anti-surge capability
 - ✓ Wirewound on ceramic element
 - ✓ RoHS compliant / lead-free
 - ✓ RWT 5 meets Akahaneohm UL file no. E255350



Electrical Specifications						
Type / Code	Element Power Rating (Watts) @ 70°C	Element + Fuse Power Rating (Watts) @ 70°C	Rated Functioning Temperature	Fusing Current	Resistance Temperature Coefficient	Ohmic Range and Tolerance
RWT 2	2 W	1.5 W	142°C	2A	±200 ppm/°C	1Ω - 100Ω
RWT 5	5 W	1.6 W	142°C	2A	±200 ppm/°C	1Ω - 100Ω
RWT 7	7 W	2 W	142°C	2A	±200 ppm/°C	1Ω - 470Ω

Performance Specifications		
Test	Test Method	Test Results
Short Time Overload	Apply DV voltage of 2.5 times the rated voltage for 5 sec.	±2%
Load Life	Apply rated DC voltage for 1.5 hr. ON and 0.5 hr. OFF. Total time of 1000 hrs.	±3%
Humidity Test (no load)	Temperature of 40°C. Humidity of 90-95% RH. Total time of 1000 hrs.	±2%
Humidity Test (rated load)	Temperature of 40°C. Humidity of 90-95% RH. Apply 1/10 rated power for 1.5 hr. ON and 0.5 hr. OFF. Total time of 1000 hrs.	±2%
Resistance to Soldering Heat	Dip lead into solder bath at temperature of 260°C x 10°C up to 1.5mm from the body of the resistor. Leave in solder bath for 10 secs. Test after 24 hrs. in room temperature	±1%
Solderability	> 95% coverage	
Insulation Resistance	R < 1GΩ	

Operating Temperature Range : -25°C to +100°C

How to Order

SEI Type		Code	Fuse Type	Nominal Value	Tolerance	Packaging			
RWT		2	A	100	5%	B			
Type	Description	Code	Fuse Type		Tolerance	Types	Qty	Description	Code
RWT	Thermal Fuse	2	A	250V 2A 142°C	5%	RWT 2	1,500	Bulk	B
		5				RWT 5	1,000		
		7				RWT 7	880		

Mechanical Specifications								
Type / Code	W	H	S	L	P	d1	d2	Unit
RWT 2	0.433 ± 0.02 11 ± 0.5	0.807 ± 0.06 20.5 ± 1.5	0.276 ± 0.04 7 ± 1	0.197 ± 0.02 5 ± 0.5	0.197 ± 0.04 5 ± 1	0.024 ± 0.002 0.6 ± 0.05	0.032 ± 0.002 0.8 ± 0.05	inches mm
RWT 5	0.512 ± 0.04 13 ± 1	0.984 ± 0.06 25 ± 1.5	0.374 ± 0.04 9.5 ± 1	0.197 ± 0.02 5 ± 0.5	0.197 ± 0.04 5 ± 1	0.024 ± 0.002 0.6 ± 0.05	0.032 ± 0.002 0.8 ± 0.05	inches mm
RWT 7	0.512 ± 0.04 13 ± 1	1.535 ± 0.06 39 ± 1.5	0.374 ± 0.04 9.5 ± 1	0.197 ± 0.02 5 ± 0.5	0.197 ± 0.04 5 ± 1	0.024 ± 0.002 0.6 ± 0.05	0.032 ± 0.002 0.8 ± 0.05	inches mm

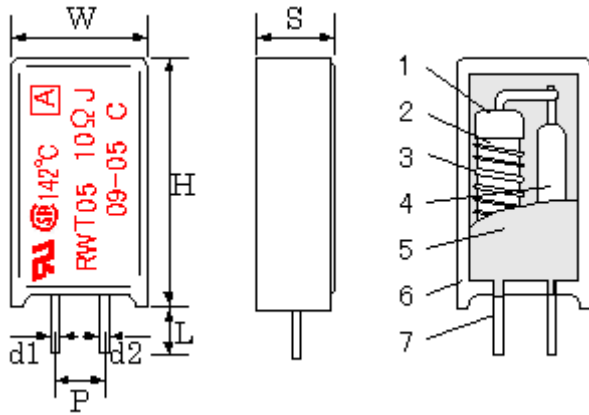

No.	Part Name
1	Cap
2	Element core
3	Resistive Wire
4	Thermal fuse
5	Enclosed cement
6	Ceramic case
7	Lead wire

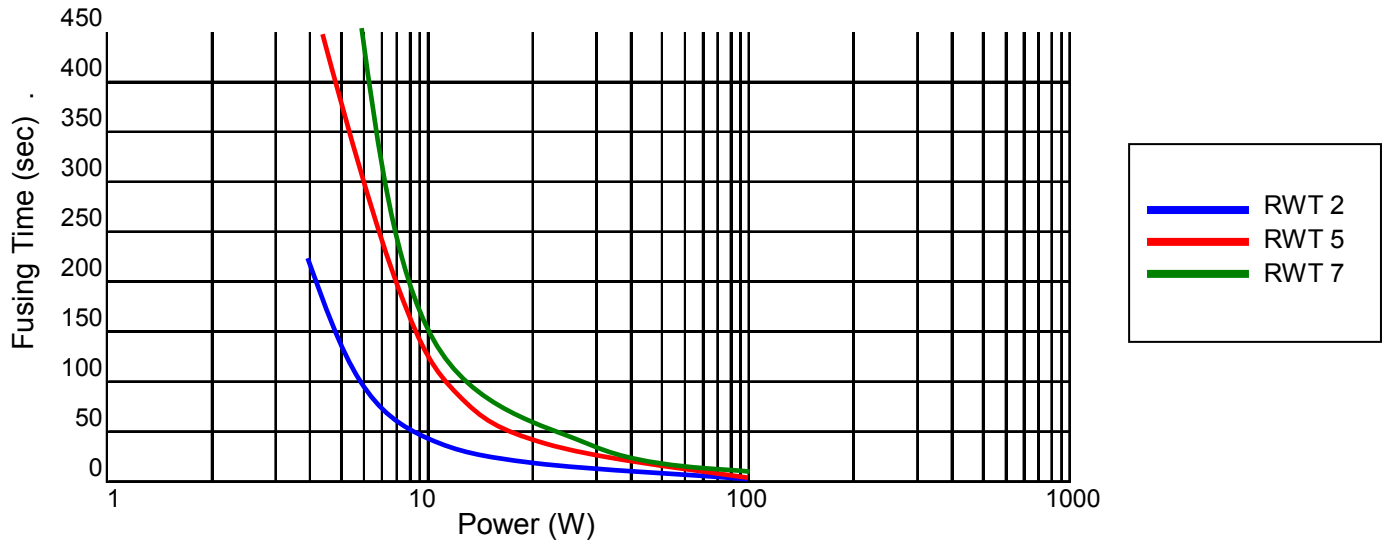

- Features:
- ✓ Special lead configurations
 - ✓ RoHS compliant / lead-free

See CB data sheet for performance and environmental specifications.

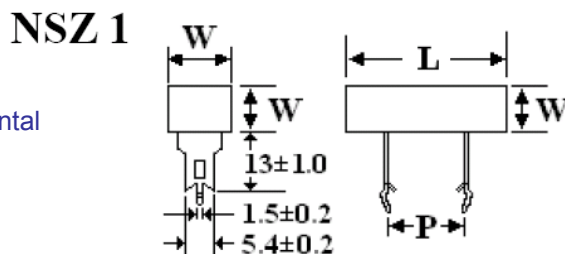

Type / Code	Power Rating (Watts) @ 25°C	Maximum Working Voltage	Resistance Range Wirewound	Resistance Range Metal Oxide	L ± 0.039 ± 1	W ± 0.039 ± 1	P ± 0.039 ± 1	Units
NSZ 1	5W	300V	1Ω - 680Ω	680Ω - 50KΩ	1.06 27	0.39 10	0.59 15	inches mm
NSZ 1	7W	350V	1Ω - 1KΩ	1K - 50KΩ	1.38 35	0.39 10	0.89 22.5	inches mm
NSZ 1	10W	500V	1Ω - 1KΩ	1K - 50KΩ	1.89 48	0.39 10	1.38 35	inches mm

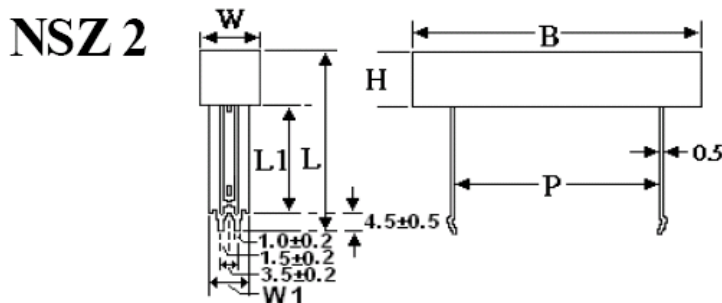

Type / Code	Power Rating (Watts) @ 25°C	Maximum Working Voltage	Resistance Range Wirewound	Resistance Range Metal Oxide	B ± 0.039 ± 1	H ± 0.02 ± 0.5	W ± 0.02 ± 0.5	W1 ± 0.004 ± 1	P ± 0.039 ± 1	L ± 0.039 ± 1	L1 +0.08/-0.04 +2/-1	Units
NSZ 2	3W	200V	0.1Ω - 470Ω	470Ω - 50KΩ	0.98 25	0.39 9.8	0.39 9.8	0.29 7.3	0.49 12.5	1.15 29.3	0.59 15	inches mm
NSZ 2	5W	300V	0.1Ω - 680Ω	680Ω - 50KΩ	1.1 28	0.39 9.8	0.39 9.8	0.29 7.3	0.59 15	1.15 29.3	0.59 15	inches mm
NSZ 2	7W	350V	0.1Ω - 1KΩ	1KΩ - 50KΩ	1.4 35.5	0.39 9.8	0.39 9.8	0.29 7.3	0.89 22.5	1.15 29.3	0.59 15	inches mm
NSZ 2	10W	500V	0.1Ω - 1.2KΩ	1.2KΩ - 50KΩ	1.89 48	0.39 9.8	0.39 9.8	0.29 7.3	1.38 35	1.15 29.3	0.59 15	inches mm
NSZ 2	15W	600V	0.1Ω - 2KΩ	2KΩ - 50KΩ	1.89 48	0.47 12	0.47 12	0.29 7.3	1.28 32.5	1.24 31.5	0.59 15	inches mm

How to Order

SEI Type		Code	Power Ratings		Nominal Resistance	Tolerance		Packaging			
NSZ		1	7		1K	5%		A			
Type	Description	Code	Code	Watts	Tolerance		Values	Types	Qty	Description	Code
NSZ	Ceramic Housed Wirewound with Specialty Leads	1	3	3W	5%		E24	All	1,000	Bulk	A
		2	5	5W							
		3	7	7W							
		4	10	10W							
			15	15W							
			20	20W							

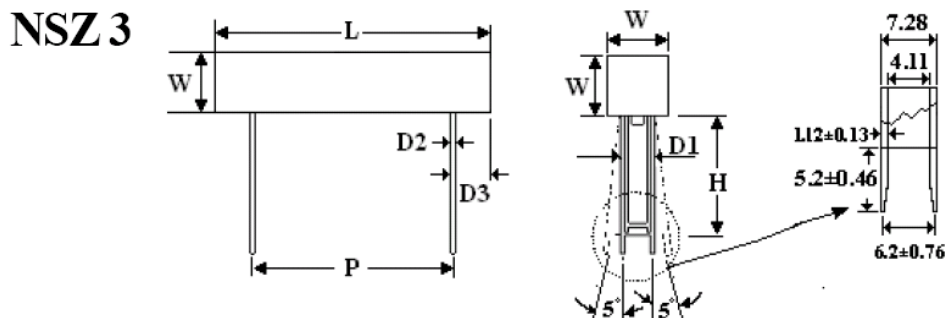

NSZ 3 Specifications

Type / Code	Power Rating (Watts) @ 25°C	Maximum Working Voltage	Resistance Range Wirewound	Resistance Range Metal Oxide	L +0.04/-0.08 +1.02/-2.03	W ±0.05 ±1.27	P ±0.06 ±1.52	H ±0.085 ±2.085	D1 ±0.012 ±0.31	D2 ±0.04 ±0.1	D3 MIN	Units
NSZ 3	5W	300V	0.1Ω - 680Ω	680Ω - 50KΩ	1.06 27	0.39 10	0.59 15	0.39 10	0.29 7.3	0.02 0.46	0.24 6.2	inches mm
NSZ 3	7W	350V	0.1Ω - 1KΩ	1KΩ - 50KΩ	1.43 36.4	0.39 10	0.89 22.49	0.98 24.93	0.29 7.28	0.02 0.46	0.15 3.81	inches mm
NSZ 3	10W	500V	0.1Ω - 1.2KΩ	1.2KΩ - 50KΩ	1.89 47.97	0.39 9.82	1.38 35.03	0.98 24.93	0.29 7.28	0.02 0.46	0.15 3.81	inches mm
NSZ 3	15W	600V	0.1Ω - 2KΩ	2KΩ - 50KΩ	1.89 47.9	0.49 12.49	1.28 32.49	0.98 24.93	0.29 7.28	0.02 0.46	0.15 3.81	inches mm

NSZ 4

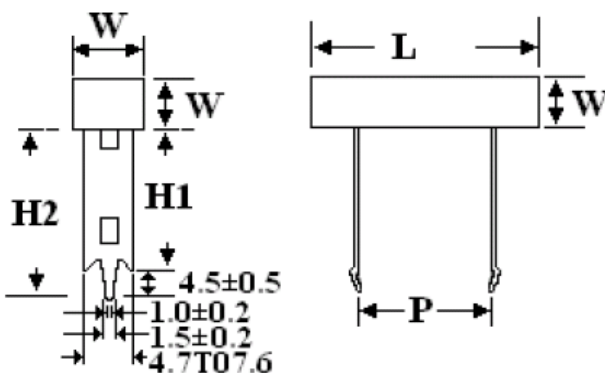

NSZ 4 Specifications

Type / Code	Power Rating (Watts) @ 25°C	Maximum Working Voltage	Resistance Range Wirewound	Resistance Range Metal Oxide	H1 ±0.039 ±1	H2 ±0.039 ±1	L MAX	P ±0.039 ±1	W MAX	Units
NSZ 4	5W	300V	0.1Ω - 680Ω	680Ω - 50KΩ	0.98 25	1.18 30	1.06 27	0.59 15	0.39 10	inches mm
NSZ 4	7W	350V	0.1Ω - 1KΩ	1KΩ - 50KΩ	0.8 25	1.26 32	1.38 35	0.94 24	0.39 10	inches mm
NSZ 4	10W	500V	0.1Ω - 2KΩ	2KΩ - 50KΩ	0.98 25	1.26 32	1.89 48	1.38 35	0.39 10	inches mm
NSZ 4	15W	600V	0.1Ω - 2KΩ	2KΩ - 50KΩ	0.98 25	1.26 32	1.89 48	1.26 32	0.47 12	inches mm
NSZ 4	20W	700V	0.1Ω - 2KΩ	2KΩ - 50KΩ	1.18 30	1.38 35	2.56 65	1.77 45	0.53 13.5	inches mm

- Features:
- ✓ Aluminum housing for maximum heat dissipation
 - ✓ Complete welded construction
 - ✓ 5 - 50W tinned copper terminals
 - ✓ Centerless ground steatite or alumina cores
 - ✓ Molded epoxy body for heat transfer
 - ✓ Non-inductive winding available
 - ✓ 100 - 250W threaded terminals
 - ✓ RoHS compliant / lead-free



Electrical Specifications								
Type / Code	MIL-R-26 Ref.	Power Rating (Watts @ 70°C)		Dielectric Withstanding Voltage	Ohmic Range and Tolerance			
		Commercial	MIL		0.1%	0.5%	1%	5%
KAL 5	RE-60	7.5W	5W	1,000 VAC	-	-	-	1Ω - 50KΩ
KAL 10	RE-65	12.5W	10W		2,500 VAC	1Ω - 1KΩ	1Ω - 1KΩ	0.05Ω - 30KΩ
KAL 25	RE-70	25W	20W	0.05Ω - 50KΩ				
KAL 50	RE-75	50W	30W	0.05Ω - 150KΩ				
KAL 100	RE-77	100W	75W	-		0.4Ω - 50KΩ		0.4Ω - 50KΩ
KAL 250	RE-80	250W	120W	-	0.6Ω - 80KΩ		0.6Ω - 80KΩ	

Temperature Coefficient Standard: ±100ppm below 0.1Ω, ±50ppm from 0.1Ω - 9.9Ω, ±30ppm from 10Ω - 49Ω, & ±20ppm above 50Ω

Performance Characteristics		
Test	Test Conditions	Results
Short time Overload	5x wattage rating - 5 seconds	$\Delta R \pm (0.5\% + 0.05\Omega)$ MAX
Moisture resistance	Temp 40°C moisture 95% CDC 100V for 500 hours	$\Delta R \pm (0.5\% + 0.05\Omega)$ MAX
Load life	Load rating (chassis is mounted) 1.5 hours ON, 0.5 hours OFF. Repeated for 1000 hours	$\Delta R \pm (1.5\% + 0.05\Omega)$ MAX

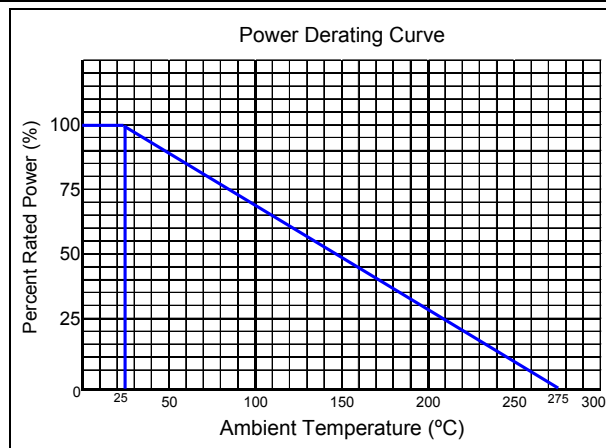

How to Order

SEI Type		Code		Nominal Resistance	Tolerance	Packaging			
KAL		10		10K	1%	B			
Type	Description	Code	Wattage	Tolerance		Types	Qty	Description	Code
KAL	Standard	5	5W	0.1%		KAL 5	50	Bulk	B
NKAL	Non-Inductive	10	10W	0.5%		KAL 10	20		
		25	25W	1%		KAL 25	10		
		50	50W	5%		KAL 50	5		
		100	100W			KAL 100	10		
		250	250W			KAL 250	5		

Mechanical Specifications																	
Type	A	B	C	D	E	F	G	H	J	K	L	M	N	P	R	S	Units
Tolerance	±0.005 ±0.1	±0.005 ±0.1	±0.031 ±0.8	±0.062 ±1.6	±0.015 ±0.4	±0.015 ±0.4	±0.031 ±0.8	±0.01 ±0.3	±0.015 ±0.4	±0.01 ±0.3	±0.005 ±0.1	±0.015 ±0.4	±0.005 ±0.1	±0.062 ±1.6	±0.01 ±0.25	±0.01 ±0.25	inches mm
KAL 5	0.394 10	0.492 12.5	0.591 15	0.984 25	0.335 8.5	0.65 16.5	0.315 8	0.063 1.6	0.157 4	0.099 2.5	0.079 2	0.079 2	0.051 1.3	0.197 5	-	-	inches mm
KAL 10	0.562 14.3	0.625 15.9	0.75 19	1.375 34.9	0.42 10.7	0.8 20.3	0.39 9.9	0.075 1.9	0.19 4.8	0.093 2.4	0.093 2.4	0.102 2.6	0.086 2.2	0.312 7.9	-	-	inches mm
KAL 25	0.719 18.3	0.781 19.8	1.062 27	1.938 49.2	0.55 14	1.08 27.4	0.546 13.9	0.088 2.2	0.26 6.6	0.172 4.4	0.125 3.2	0.115 2.9	0.086 2.2	0.438 11.1	-	-	inches mm
KAL 50	1.563 39.7	0.844 21.4	1.968 50	2.781 70.6	0.63 16	1.14 29	0.61 15.5	0.088 2.2	0.3 7.6	0.196 5	0.125 3.2	0.107 2.7	0.086 2.2	0.41 10.4	-	-	inches mm
KAL 100	2.75 69.9	2.25 57.2	3.5 88.9	5.48 139.2	1.89 48	2.81 71.4	2.18 55.6	0.19 4.8	0.96 24.3	0.37 9.5	0.19 4.8	0.29 7.1	-	0.99 25.12	-	-	inches mm
KAL 250	3.87 98.4	2.5 63.5	4.5 114.3	7 177.8	2.13 54	3 76.2	2.19 55.6	0.25 6.4	0.96 24.3	0.31 7.9	0.19 4.8	0.25 6.4	-	1.25 31.8	0.87 22.2	3 76.2	inches mm

KAL 5 - 50

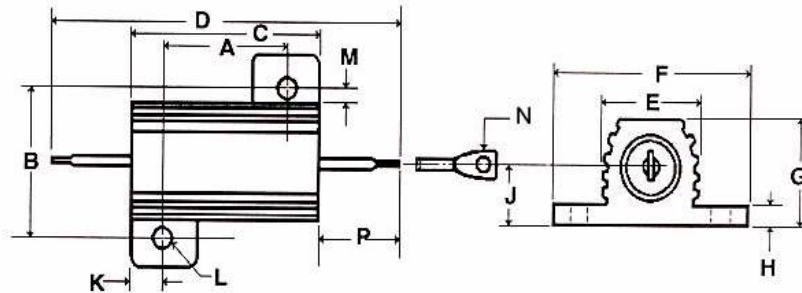

KAL 100

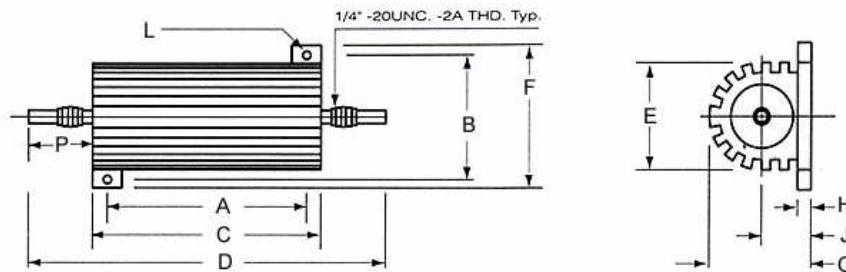

KAL 250

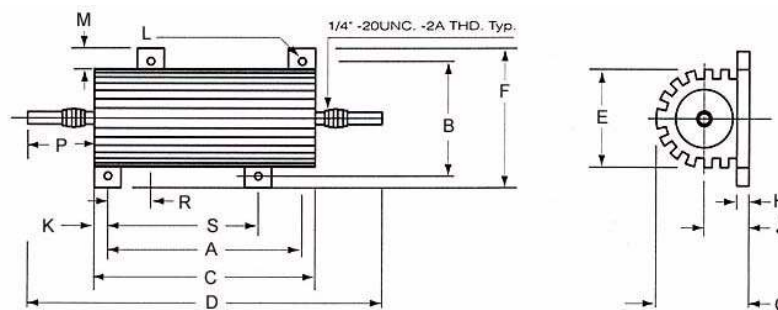

- Features:**
- ✓ High current capability
 - ✓ RoHS compliant / lead-free
 - ✓ Non-inductive style only available with silicone coating (NSWT)
 - ✓ Suitable for soldering or thru bolt connections
 - ✓ Wirewound ribbon on ceramic substrate
 - ✓ SWT – Silicone coating provides temperature handling up to 350°C
 - ✓ EWT – Vitreous enamel coating provides temperature handling up to 500°C



Electrical Specifications						
Type / Code	Power Rating (Watts) @ 70°C	Dielectric Strength VAC	Ohmic Range and Tolerance 5% and 10%			
			SWT	NSWT	EWT	
SWT 12 / EWT 12	12W	1,000	0.1Ω - 51KΩ	0.1Ω - 53Ω	0.1Ω - 5KΩ	
SWT 25 / EWT 25	25W	2,500	1Ω - 30KΩ	0.1Ω - 100Ω	0.1Ω - 10KΩ	
SWT 50 / EWT 50	50W	2,500	0.1Ω - 50KΩ	0.1Ω - 275Ω	0.1Ω - 20KΩ	
SWT 100 / EWT 100	100W	2,500	0.1Ω - 100KΩ	0.12Ω - 680Ω	0.1Ω - 50KΩ	
SWT 150 / EWT 150	150W	2,500	0.1Ω - 150KΩ	0.22Ω - 1.5KΩ	0.1Ω - 80KΩ	
SWT 175 / EWT 175	175W	2,500	0.15Ω - 100KΩ	0.24Ω - 1.3KΩ	0.1Ω - 100KΩ	
SWT 200 / EWT 200	200W	2,500	0.1Ω - 200KΩ	0.25Ω - 1.35KΩ	0.1Ω - 120KΩ	
SWT 225 / EWT 225	225W	2,500	0.2Ω - 130KΩ	0.3Ω - 1.7KΩ	0.12Ω - 130KΩ	
SWT 250 / EWT 250	250W	2,500	0.5Ω - 250KΩ	0.33Ω - 1.8KΩ	0.5Ω - 200KΩ	
SWT 300 / EWT 300	300W	2,500	0.5Ω - 300KΩ	0.42Ω - 2.25KΩ	0.5Ω - 240KΩ	
SWT 400 / EWT 400	400W	2,500	0.5Ω - 400KΩ	0.54Ω - 3KΩ	0.5Ω - 300KΩ	
SWT 500 / EWT 500	500W	2,500	0.5Ω - 500KΩ	0.77Ω - 4.2KΩ	0.5Ω - 400KΩ	
SWT 700 / EWT 700	700W	2,500	1Ω - 600KΩ	1Ω - 5.3KΩ	1Ω - 500KΩ	
SWT 1000 / EWT 1000	1000W	2,500	1Ω - 1MΩ	1.4Ω - 7.6KΩ	1Ω - 750KΩ	
SWT 1300 / EWT 1300	1300W	2,500	1Ω - 1.3MΩ	2Ω - 10KΩ	1Ω - 1MΩ	

How to Order

SEI Type		Termination		Code		Nominal Resistance	Tolerance	Packaging	
EWT		M		50		200	5%	B	
Type	Description	Code	Description	Power Rating		Tolerance		Code	Description
SWT	Silicone Coating (std)	-	Std Tab Connection	12	225	5%		B	Bulk
EWT	Vitreous Enamel	M	Mounting Hardware	25	250	10%			
NSWT	Non-Inductive Silicone Coating	S	Spring Clips	50	300				
		L	Welded Straight Leads	100	400				
				150	500				
				175	700				
				200	1000				
				1300					

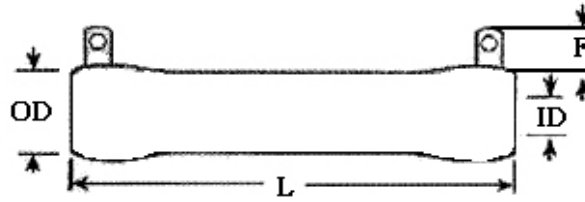

Mechanical Specifications					
Type / Code [Ⓞ]	OD	ID	F	L	Units
SWT 12 / EWT 12	0.31 ± 0.04 7.94 ± 1	0.188 ± 0.04 4.76 ± 1	0.47 ± 0.04 12 ± 1	1.75 ± 0.08 44.5 ± 2	inches mm
SWT 25 / EWT 25	0.56 ± 0.04 14.3 ± 1	0.31 ± 0.04 7.94 ± 1	0.47 ± 0.04 12 ± 1	2 ± 0.08 51 ± 2	inches mm
SWT 50 / EWT 50	0.56 ± 0.04 14.3 ± 1	0.31 ± 0.04 7.94 ± 1	0.75 ± 0.04 19 ± 1	4 ± 0.08 102 ± 2	inches mm
SWT 100 / EWT 100	0.75 ± 0.04 19.1 ± 1	0.5 ± 0.04 12.7 ± 1	0.67 ± 0.04 17 ± 1	6.5 ± 0.08 165 ± 2	inches mm
SWT 150 / EWT 150	1.1 ± 0.04 28 ± 1	0.75 ± 0.04 19.1 ± 1	0.67 ± 0.04 17 ± 1	7.11 ± 0.08 206 ± 2	inches mm
SWT 175 / EWT 175	1.13 ± 0.04 28.6 ± 1	0.75 ± 0.04 19.1 ± 1	0.67 ± 0.04 17 ± 1	8.5 ± 0.08 216 ± 2	inches mm
SWT 200 / EWT 200	1.38 ± 0.04 35 ± 1	0.75 ± 0.04 19.1 ± 1	0.67 ± 0.04 17 ± 1	8.74 ± 0.08 222 ± 2	inches mm
SWT 225 / EWT 225	1.125 ± 0.04 28.6 ± 1	0.75 ± 0.04 19.1 ± 1	0.71 ± 0.04 18 ± 1	10.5 ± 0.08 267 ± 2	inches mm
SWT 250 / EWT 250	1.57 ± 0.04 40 ± 1	1.125 ± 0.04 28.6 ± 1	0.71 ± 0.04 18 ± 1	8.74 ± 0.08 222 ± 2	inches mm
SWT 300 / EWT 300	1.57 ± 0.04 40 ± 1	1.125 ± 0.04 28.6 ± 1	0.71 ± 0.04 18 ± 1	10.71 ± 0.08 272 ± 2	inches mm
SWT 400 / EWT 400	1.57 ± 0.04 40 ± 1	1.125 ± 0.04 28.6 ± 1	0.71 ± 0.04 18 ± 1	13.46 ± 0.08 342 ± 2	inches mm
SWT 500 / EWT 500	2.5 ± 0.04 63.5 ± 1	1.75 ± 0.04 44.5 ± 1	1.1 ± 0.04 28 ± 1	12 ± 0.08 305 ± 2	inches mm
SWT 700 / EWT 700	1.97 ± 0.04 50 ± 1	1.41 ± 0.04 35.7 ± 1	1.1 ± 0.04 28 ± 1	18.18 ± 0.08 462 ± 2	inches mm
SWT 1000 / EWT 1000	2.50 ± 0.04 63.5 ± 1	1.75 ± 0.04 44.5 ± 1	1.18 ± 0.04 30 ± 1	20 ± 0.08 508 ± 2	inches mm
SWT 1300 / EWT 1300	2.56 ± 0.04 65 ± 1	1.75 ± 0.04 44.5 ± 1	1.18 ± 0.04 30 ± 1	26.26 ± 0.08 667 ± 2	inches mm

Ⓞ EWT and NSWT series will have the same Mechanical Specifications as SWT series

Power Derating Curve:

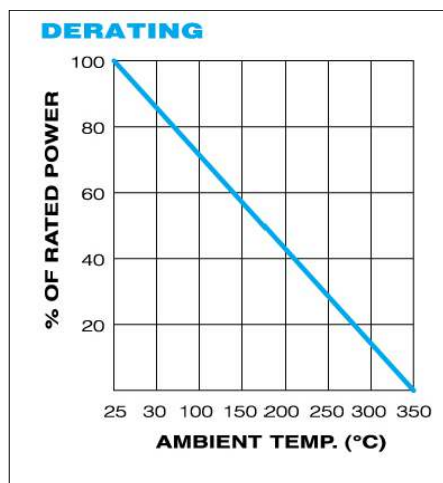

The SHP series of resistors is a thick film on steel technology uniquely suited for wide-scale usage in resistor and heating applications where high power density, surge handling, and low inductance are required in a defined space.

The SHP series differentiates itself from other thick film on metal products through the manner in which the resistive film is deposited. Other manufacturers utilize crude screen-printing processes, while the SHP series employs a precision fine film dispensing system, capable of writing quality resistive traces on a non-corrosive stainless steel substrate.



- Features:**
- ✓ Superior thermal transfer
 - ✓ Superior shock and vibration strength
 - ✓ Integrated fusing for failsafe circuit protection
 - ✓ Design provides low inductance
 - ✓ RoHS compliant / lead-free
 - ✓ Reduced size compared to power wirewounds
 - ✓ Flameproof package
 - ✓ Current and temperature sense options available
 - ✓ Custom mounting and lead attachment

Electrical Specifications						
Category	SHP 1/2	SHP 1	SHP 2	SHP 3	SHP 5	SHP 7
Maximum Pulse Power ①④	0.5KW	1.5KW	2KW	3.5KW	5KW	7KW
Maximum Continuous Load without Cooling ②	160W	180W	200W	260W	270W	280W③
Maximum Continuous Load with Cooling ①	300W	700W	780W	900W	1,000W	1,490W③
Resistance Values	22Ω, 47Ω, 100Ω	12Ω, 22Ω, 47Ω, 100Ω, 150Ω				47Ω, 100Ω, 150Ω
Minimum Dielectric Withstanding Voltage	2,500V DC					
Maximum Resistor "hotspot" Temperature	365°C					
Stability (nominal load) after 50K cycles	ΔR < ±5%					
Inductance (Typical)	<3μH	<3μH	<3μH	<4μH	<5μH	<6μH

① Testing carried out on a heatsink (thermal resistance 0.53°C/W), force cooled at 5m/s air velocity for 50K cycles.

② Testing carried out on a heatsink (thermal resistance 0.53°C/W), with no air-cooling, Rt = 25°C.

③ Limited by the solder type, the maximum continuous load can be improved with HMP solder.

④ Maximum Pulse Power is determined using a duty cycle of 1:5

Application Notes

It is important to select a heatsink with low thermal resistance (typically ≤0.53°C/W) to enable the component to operate at its continuous power rating. Data for heatsinks with higher thermal resistance can be found in additional performance specification. The SHP resistor series will “failsafe” (open circuit) under overload (fault) conditions while maintaining a dielectric withstanding voltage of 1KV min.

- Appropriately apply thermal grease between the heatsink and the resistor
- The resistor should be mounted using the appropriate screw and torquing to a maximum of 2.5±10%Nm.
 - * M5 screw head bolt for SHP 2, 3, 5 & 7;
 - * M3 screw head bolt for SHP 1;
 - * M2 screw head bolt for SHP 1/2.
- The mounting area of the heatsink must have a surface finish of ≤6.3m with a flatness of ≤0.05mm.
- Forced air cooling is required.

How to Order

SEI Type	Termination	Power Rating	Nominal Resistance	Tolerance	Packaging																														
SHP	I	3	47	10%	A																														
	<table border="1"> <thead> <tr> <th>Code</th> <th>Termination</th> </tr> </thead> <tbody> <tr> <td>I</td> <td>Solder Coated Conductors</td> </tr> <tr> <td>L</td> <td>Flying Leads</td> </tr> <tr> <td>T</td> <td>Push-On Connections</td> </tr> </tbody> </table>	Code	Termination	I	Solder Coated Conductors	L	Flying Leads	T	Push-On Connections	<table border="1"> <thead> <tr> <th>Code</th> <th>Wattage</th> </tr> </thead> <tbody> <tr> <td>1/2</td> <td>0.5KW</td> </tr> <tr> <td>1</td> <td>1.5KW</td> </tr> <tr> <td>2</td> <td>2KW</td> </tr> <tr> <td>3</td> <td>3.5KW</td> </tr> <tr> <td>5</td> <td>5KW</td> </tr> <tr> <td>7</td> <td>7KW</td> </tr> </tbody> </table>	Code	Wattage	1/2	0.5KW	1	1.5KW	2	2KW	3	3.5KW	5	5KW	7	7KW		<table border="1"> <thead> <tr> <th>Tolerance</th> </tr> </thead> <tbody> <tr> <td>± 10%</td> </tr> </tbody> </table>	Tolerance	± 10%	<table border="1"> <thead> <tr> <th>SEI Types</th> <th>Description</th> <th>Code</th> </tr> </thead> <tbody> <tr> <td>All</td> <td>Bulk</td> <td>A</td> </tr> </tbody> </table>	SEI Types	Description	Code	All	Bulk	A
Code	Termination																																		
I	Solder Coated Conductors																																		
L	Flying Leads																																		
T	Push-On Connections																																		
Code	Wattage																																		
1/2	0.5KW																																		
1	1.5KW																																		
2	2KW																																		
3	3.5KW																																		
5	5KW																																		
7	7KW																																		
Tolerance																																			
± 10%																																			
SEI Types	Description	Code																																	
All	Bulk	A																																	

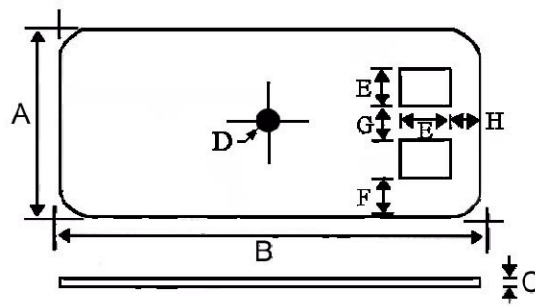

Mechanical Specifications									
Type / Code	A	B	C	D	E	F	G	H	Units
Tolerance	±0.004	±0.004	±0.004	±0.004	±0.004	±0.004	±0.004	±0.004	inches
	±0.1	±0.1	±0.1	±0.1	±0.1	±0.1	±0.1	±0.1	mm
SHP 1/2	1.11 28.08	1.25 31.85	0.04 0.90	0.09 2.20	0.35 9.00	0.30 7.50	0.12 3.10	0.17 4.30	inches mm
SHP 1	1.41 35.85	1.94 49.30	0.04 0.90	0.13 3.20	0.35 9.00	0.13 3.20	0.44 11.20	0.24 6.20	inches mm
SHP 2	1.60 40.64	2.40 60.96	0.04 0.90	0.21 5.30	0.35 9.00	0.19 4.70	0.51 13.00	0.22 5.80	inches mm
SHP 3	2.76 70.00	4.00 101.60	0.04 0.90	0.21 5.30	0.35 9.00	0.53 13.50	0.87 22.00	0.40 10.20	inches mm
SHP 5	2.76 70.00	4.80 122.00	0.04 0.90	0.21 5.30	0.35 9.00	0.55 14.00	0.94 23.80	0.29 7.40	inches mm
SHP 7	4.00 101.60	6.00 152.40	0.06 1.50	0.21 5.30	0.35 9.00	0.59 15.00	2.02 51.30	0.36 9.20	inches mm

Termination Style

SHP Series are available with solder coated conductors (I), flying leads (L), or push-on connections (T):

Style I, standard solder coated conductors;

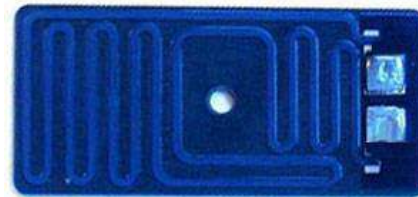

Style L, flying leads, a 250mm long cable, rated up to 40A, are attached to the resistor. Cables conform to UL3134.



Style T, standard push on connections.

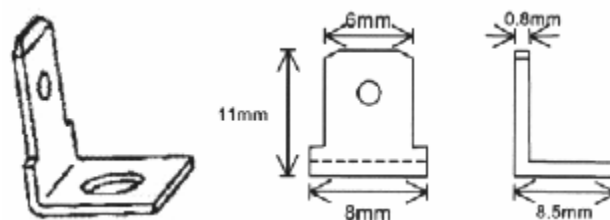

Terminations

The following Termination options are available:

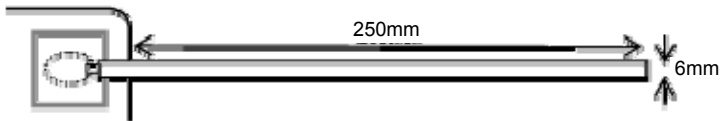
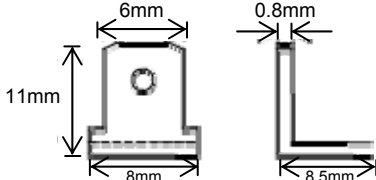
Option	Code	Nominal Dimensions
Solder pad only SnAg (96S)	I	
Flying leads UL3134 40A, 600V	L	
Push-on connectors (SHP 1,2,3,5 & 7)	T	

Performance Data

	Maximum
Pulsed load at full pulse power rating 50,000 cycles (see Fig. 1)	
Mounted on a 0.53°C/W heatsink with 5m/s forced air cooling, air temperature 25°C	ΔR% 5
Derating at heatsink temperatures > 160°C	See Fig. 2

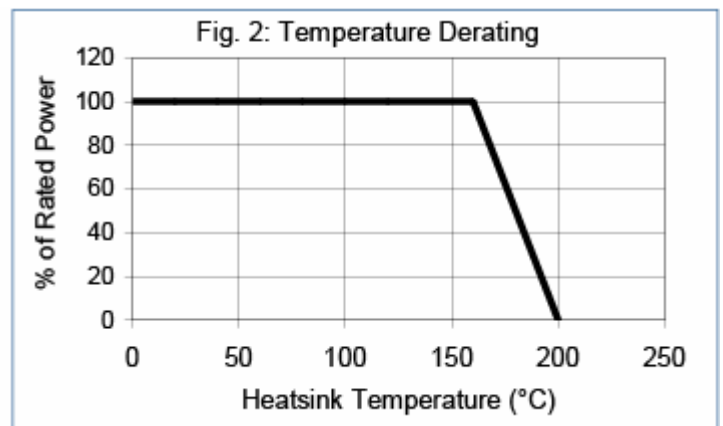
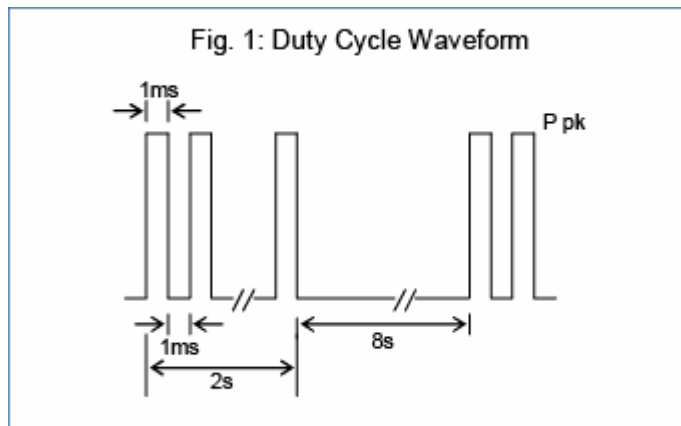

Application Notes

A heatsink with thermal resistance $\leq 0.53^\circ\text{C/W}$ will enable the component to operate at its continuous power rating. Thermal grease (e.g. Dow Corning DC340) should be used and the heatsink should have a surface finish of $<6.3\mu\text{m}$ with flatness of $<0.05\text{mm}$. The resistor should be mounted using a screw head bolt of size M5 for SHP 2, 3, 5 & 7, M3 for SHP1 and M2 for SHP1/2. This should be torqued to $2.5\text{Nm} \pm 10\%$.

SHP resistors will fail safe (open circuit) under overload fault conditions and still maintain a 1KV dielectric withstand.

Overload conditions

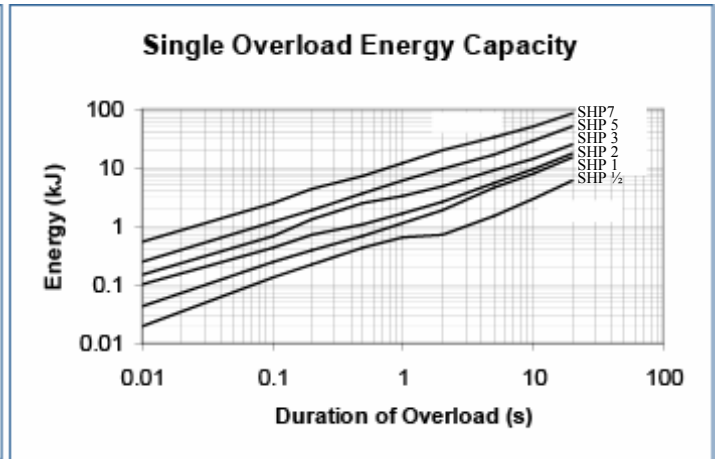
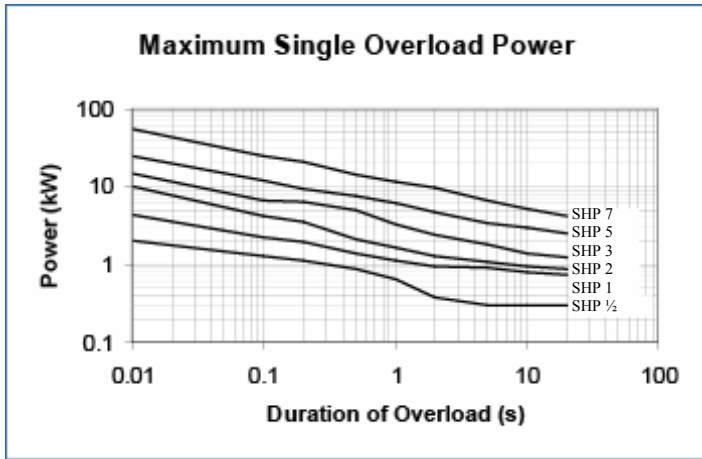

The HPC series represents a breakthrough in functional design, thermal management and end-user benefits. Borrowing from long-proven techniques used in power semiconductors, the HPC series provides up to eight times more useful power than SMD power resistors currently available.

The HPC series, through superior characterization, is intended to remove the mystery of managing board level power by combining established techniques in new ways. The result is superior technology in design options, in a cost effective package.



- Features:**
- ✓ Up to 12W with no external heat sinks
 - ✓ Compatible with conventional pick and place
 - ✓ Only 0.5 x 0.5 PCB footprint
 - ✓ Non-inductive resistive element
 - ✓ Anodized heat sink top provides 800V voltage withstanding
 - ✓ Up to 50W for short duration
 - ✓ Stackpole patent no. US 7,286,358 B2
 - ✓ Available in 1% and 5% tolerance
 - ✓ RoHS compliant / lead-free

Electrical Specifications								
Type / Code	Power Rating (Watts) @ 40°C w/400 LFM air flow	Power Rating (Watts) @ 40°C no air flow	Maximum Working Voltage	Maximum Overload Voltage	Dielectric Strength	Inductance	Resistance Temperature Coefficient	Ohmic Range and Tolerance
HPC 12	12W	5W	200V	400V	1,500V	<2nH	±150 ppm/°C	0.025Ω - 250KΩ 1%, 5%

Dimensions
+/- 0.010

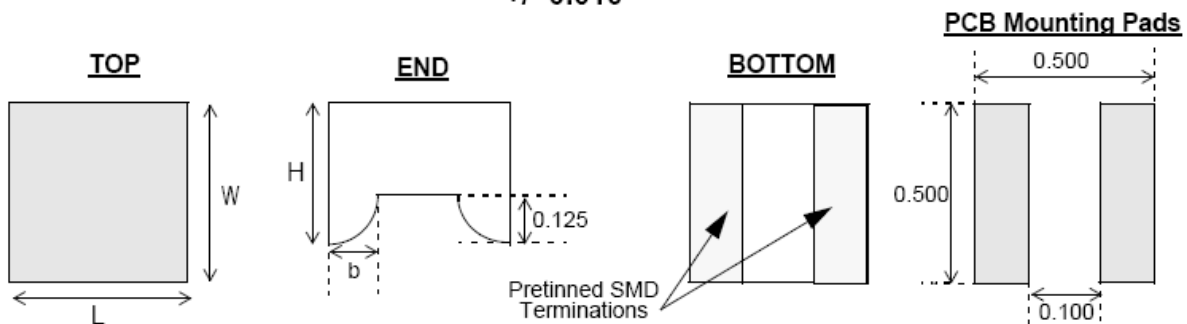

Mechanical Specifications					
Type / Code	L Body Length	W Body Width	H Body Height	b Bottom Termination	Units
HPC 12	0.48 12.18	0.5 12.69	0.4 10.15	0.11 2.79	inches mm

How to Order

SEI Type	Code	Nominal Resistance	Tolerance	Packaging
HPC	12	1K	5%	R

Type	Description	Code	Tolerance	Types	Qty	Description	Code
HPC	High Power SMD	1/2	1%	HPC 12	200	Standard Reel	R
			5%		100	Bulk	B

Performance Characteristics		
Test	Test Conditions (JIS C 5202)	Test Results
Short Time Overload	2.5x rated voltage for 5 seconds	$\pm(2\% + 0.1\Omega)$
Dielectric Withstanding Voltage	100VAC, 1 minute	$\pm(1\% + 0.05\Omega)$
Resistance to Soldering Heat	260°C $\pm 5^\circ\text{C}$ for 10 sec; ± 0.5 sec (Solder Bath)	$\pm(1\% + 0.05\Omega)$
Solderability	235°C $\pm 5^\circ\text{C}$ for 2 sec.; ± 0.5 sec (Colophonium flux)	95% coverage, minimum
Temperature Cycle	-65°C: 30 min.; 25°C: 2 to 3 min. 150°C: 30 min.; 25°C: 2 to 3 min. (5 cycles)	$\pm(1\% + 0.05\Omega)$ Jumper ($<0.05\Omega$)
Endurance (Damp load)	40°C $\pm 2^\circ\text{C}$, 90% to RH, rated load 90 min. ON, 30 min. OFF for 1,000 hrs. -0 hrs. / +48 hrs.	$\pm(3\% + 0.1\Omega)$ Jumper ($<0.05\Omega$)
Endurance (Rated load)	70°C $\pm 2^\circ\text{C}$, 90% to RH, rated load 90 min. ON, 30 min OFF for 1,000 hrs. -0 hrs. / +48 hrs.	$\pm(3\% + 0.1\Omega)$ Jumper ($<0.05\Omega$)
Voltage Coefficient	1/10 rated voltage for 3 sec. max. then rated voltage for 3 sec. max.	± 100 (ppm/V)
Robustness of Termination	Bend of 3mm for 5 \pm 1 sec.	$\pm(1\% + 0.05\Omega)$

HPC 12 Power Derating Curve

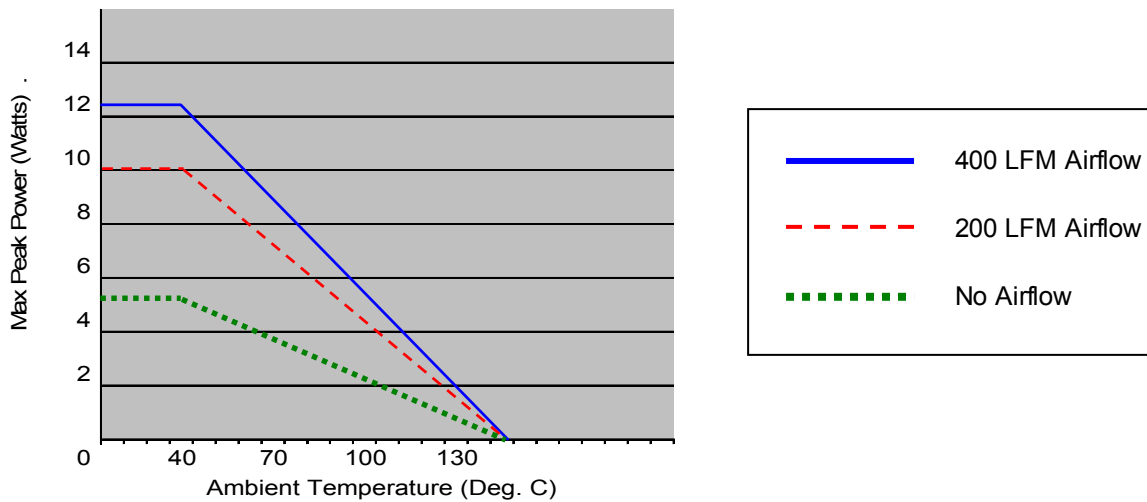

HPC 12 Power vs. Duration

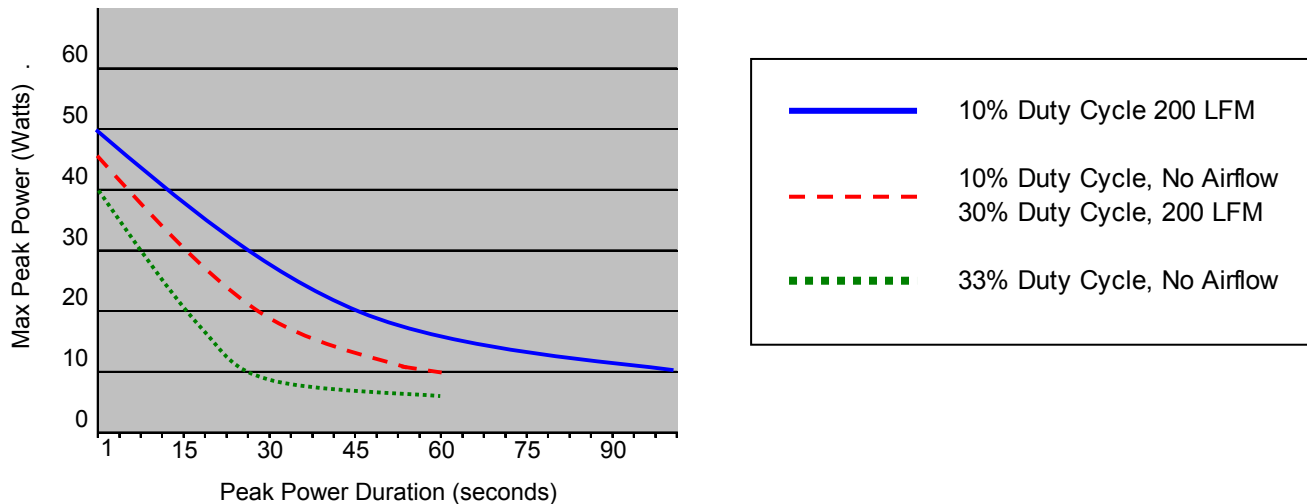

TR Series

TO-220 and TO-247 Style Power Resistors

Stackpole Electronics, Inc.

Resistive Product Solutions

- Features:
- ✓ TR20/30/35/50 comes in TO-220 style power package
 - ✓ TR100 available in TO-247 style power package
 - ✓ TR30/35/100 has single screw mounting to heat sink
 - ✓ Molded case for environmental protection
 - ✓ Electrically isolated case
 - ✓ Non-inductive package



Electrical Specifications								
Type / Code	Power Rating (Watts) @ 25°C with Heat Sink	Package Style	Maximum Working Voltage ^①	Resistance Temperature Coefficient	Ohmic Range and Tolerance			
					0.5%	1%	5%	10%
TR 20	20W	TO-220	350V	±50 ppm/°C	11Ω - 10KΩ	11Ω - 10KΩ	11Ω - 10KΩ	11Ω - 10KΩ
TR 30	30W	TO-220		±100 ppm/°C	11Ω - 10KΩ	5Ω - 10KΩ	5Ω - 10KΩ	5Ω - 10KΩ
TR 35	35W	TO-220		±200 ppm/°C	11Ω - 10KΩ	1.1Ω - 10KΩ	1.1Ω - 10KΩ	1.1Ω - 10KΩ
TR 50	50W	TO-220		-	-	0.05Ω - 10KΩ	0.05Ω - 10KΩ	0.05Ω - 10KΩ
TR 100	100W	TO-247	±50 ppm/°C	-	10Ω - 10KΩ	10Ω - 10KΩ	10Ω - 10KΩ	
			±100 ppm/°C	-	3.1Ω - 10KΩ	3.1Ω - 10KΩ	3.1Ω - 10KΩ	
			-	-	1Ω - 30KΩ	1Ω - 30KΩ	1Ω - 30KΩ	

① Lesser of \sqrt{PR} or maximum working voltage

② Unspecified TCR. Contact Factory

Environmental Characteristics			
Test Item	Specification		Test Method
	TR20/30/35/50	TR100	
Short Time Overload	$\Delta R \pm (0.3\% + 0.001\Omega)$	$\Delta R \pm (0.5\% + 0.001\Omega)$	2 times rated power with applied voltage not to exceed 1.5 times maximum continuous operating voltage for 5 seconds
Load Life	$\Delta R \pm (1\% + 0.001\Omega)$	$\Delta R \pm (1\% + 0.001\Omega)$	MIL-R-39009, 2000 hours at rated power
Moisture Resistance	$\Delta R \pm (0.5\% + 0.001\Omega)$	$\Delta R \pm (0.5\% + 0.001\Omega)$	MIL-STD-202, Method 103B
Thermal Shock	$\Delta R \pm (0.3\% + 0.001\Omega)$	$\Delta R \pm (0.5\% + 0.001\Omega)$	MIL-STD-202, Method 107G
Terminal Strength	$\Delta R \pm (0.2\% + 0.001\Omega)$	$\Delta R \pm (0.2\% + 0.001\Omega)$	MIL-STD-202, Method 211, Condition A (Pull Test) 2.4N
Vibration, High Frequency	$\Delta R \pm (0.2\% + 0.001\Omega)$	$\Delta R \pm (0.4\% + 0.001\Omega)$	MIL-STD-202, Method 204, Condition D
Dielectric Strength			1800VAC
Insulation Resistance			10GΩ min.

Operating Temperature Range: -65°C to + 150°C (TR20/30/35/50)

-65°C to + 175°C (TR100)

How to Order

SEI Type		Code		TCR		Nominal Resistance	Tolerance	Packaging ^③			
TR		20		T1		1K	1%	B			
Type	Description	Code	Wattage	Code	TCR	Tolerance		Style	Qty	Description	Code
TR	Standard	20	20W	-	Unspecified	±0.5%		TR 30, 35	700	Box	B
		30	30W	T2	50 ppm	±1%		TR 20, 50, 100	1,000		
		35	35W	T1	100 ppm	±5%					
		50	50W	T0	200 ppm	±10%					
		100	100W								

③ Tube Packaging may be available for large volumes. Please contact factory for details.

Mechanical Specifications						
Type / Code	TR20	TR30	TR35	TR50	TR100	Units
A	0.41 x 0.01 10.41 x 0.26	0.41 x 0.01 10.41 x 0.26	0.4 x 0.01 10.16 x 0.25	0.41 x 0.01 10.41 x 0.26	0.62 x 0.01 15.75 x 0.26	inches mm
B	0.64 x 0.01 16.26 x 0.26	0.64 x 0.01 16.26 x 0.26	0.58 x 0.01 14.75 x 0.25	0.64 x 0.01 16.26 x 0.26	0.815 x 0.01 20.7 x 0.26	inches mm
C	0.125 x 0.01 3.18 x 0.26	0.125 x 0.01 3.18 x 0.26	0.17 x 0.015 4.44 x 0.38	0.125 x 0.01 3.18 x 0.26	0.195 x 0.01 4.95 x 0.26	inches mm
D	0.05 x 0.005 1.27 x 0.13	0.05 x 0.005 1.27 x 0.13	0.05 x 0.005 1.27 x 0.13	0.05 x 0.005 1.27 x 0.13	0.143 x 0.007 3.63 x 0.18	inches mm
E	0.03 x 0.004 0.76 x 0.1	0.03 x 0.004 0.76 x 0.1	0.031 x 0.003 0.78 x 0.08	0.03 x 0.004 0.76 x 0.1	0.06 x 0.004 1.52 x 0.1	inches mm
F	0.2 x 0.01 5.08 x 0.26	0.2 x 0.01 5.08 x 0.26	0.2 x 0.01 5.08 x 0.26	0.2 x 0.01 5.08 x 0.26	0.4 x 0.01 10.16 x 0.26	inches mm
G	0.13 x 0.03 3.3 x 0.76	0.13 x 0.03 3.3 x 0.76	0.13 x 0.03 3.3 x 0.76	0.13 x 0.03 3.3 x 0.76	0.11 x 0.03 2.79 x 0.76	inches mm
H	0.5 x 0.05 12.7 x 1.27	0.5 x 0.05 12.7 x 1.27	0.539 x 0.04 13.7 x 1	0.5 x 0.05 12.7 x 1.27	0.57 x 0.05 14.48 x 1.27	inches mm
J	0.019 x 0.004 0.5 x 0.1	0.019 x 0.004 0.5 x 0.1	0.024 x 0.003 0.62 x 0.08	0.019 x 0.004 0.5 x 0.1	0.032 x 0.01 0.81 x 0.26	inches mm
K	0.07 x 0.01 1.78 x 0.26	0.07 x 0.01 1.78 x 0.26	0.09 x 0.01 2.28 x 0.25	0.07 x 0.01 1.78 x 0.26	0.095 x 0.01 2.41 x 0.26	inches mm
M	-	-	0.144 x 0.004 3.65 x 0.1	-	0.143 x 0.004 3.63 x 0.18	inches mm
N	-	-	0.116 x 0.004 2.95 x 0.1	-	0.21 x 0.01 5.33 x 0.26	inches mm
O	-	-	0.051 x 0.004 1.3 x 0.1	-	-	inches mm
P	-	-	0.24 x 0.004 6.1 x 0.1	-	-	inches mm

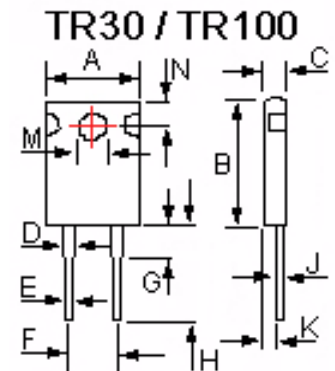
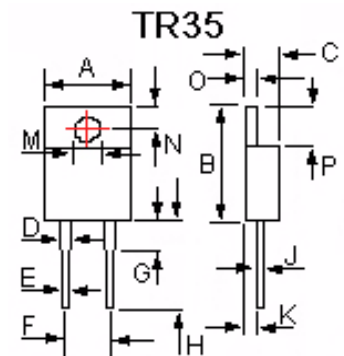
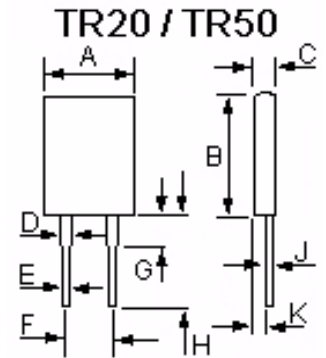

Mounting Note: When mounting ensure entire ceramic portion of case is mounted on a clean, flat heat sink with an appropriate thermal interface, such as thermal grease. For screw mounting use of a compression washer at a force of 150 to 300lbs (665 to 1330N) is recommended without exceeding mounting torque of 8 in-lbs (0.9 N-m) to avoid package damage. For clip mounting use of a round or smooth clip in contact area is recommended to avoid a concentrated hot spot on package.

Electrical Thermal Characteristics					
	TR20	TR30	TR35	TR50	TR100
Free Air Power Rating	3W in free air at 25°C	2.25W in free air at 25°C	2.5W in free air at 25°C	3W in free air at 25°C	3.5W in free air at 25°C
The case temperature is to be used for the definition of the applied power limit					
The case temperature measurement must be made with a thermocouple contacting the center of the component mounted on the designed heat sink					
TR50/100 must be mounted to heat sink using proper mounting clip for efficient heat dissipation					

This one definitely tops the FAQ list. Chip resistors and axial leaded resistors all seem to have various different wattage ratings depending on the manufacturer and even within the same manufacturer. This is completely illogical because intuition of the physics involved says that parts that are the same size, and are made of similar materials, will be able to handle the same power in a given application. So, why all the confusion?

Chip Resistors

First in the surface mount world, let's choose the 1206 size chip resistor as our example. For many years (and still today, for EIA power ratings), this size resistor was considered an 1/8 watt part. These ratings were based on older design rules, and on a mindset influenced by the military. The military has traditionally been conservative in how they rate electrical components and this case is no different. A 1206 used in an application where it will only need to handle 1/8 watt, will typically shift around 0.2% from its original value over the life of the part, per 1000 hours.

More recently, the CECC (a committee similar to EIA in Europe) has chosen to rate the 1206 size resistor at 1/4 watt. Similarly the 0603 size rating was increased to 1/10 from 1/16, the 0805 increased to 1/8 from 1/10, and so on. These ratings were based on the fact that certain guidelines have been established in the circuit board industry, so that the worst-case scenario is now not nearly so bad. The same 1206 from our previous example, but now used in a 1/4 watt application, will experience a typical shift of around 0.25% per 1000 hours. This is clearly not much greater than the shift at the lower 1/8 watt power level, so the resistor industry has, for the most part, adopted the higher power rating as the standard.

What is confusing is that there are many designs that have originated some years ago and thus still use the lower power rating. This should not pose a problem, since a higher power rating than required is almost always acceptable. The key to surface mount resistors and their substitutions is to compare size vs. size as long as the rated power of the part utilized is greater than or equal to that required in the application. After all, it is the physical size of the part that determines whether it will retrofit into a particular board, not the power rating.

Axial Leaded Resistors

A similar argument can be made for axial leaded resistors. If physics says that parts of the same size, and relatively the same material should handle the same amount of power, then why are there 1/4 watt and 1/2 watt parts with the same dimensions?

Our surface mount discussion still holds true here. An 1/8 watt part can usually handle more power, but it is at the expense of higher ambient and board temperatures, and a more extreme resistance shift over the life of the part. Again, the rule of thumb should be to try to match parts of the same dimension rather than of the same wattage.

If the application can withstand a little more heat generated and a little more resistance shift over the life of the product, then there should not be any issues with using the parts at their higher power rating.

**Radial Lead Taping Specification – Pana-Sert
Carbon Film & Metal Film Resistors (1/4W Body Size)**

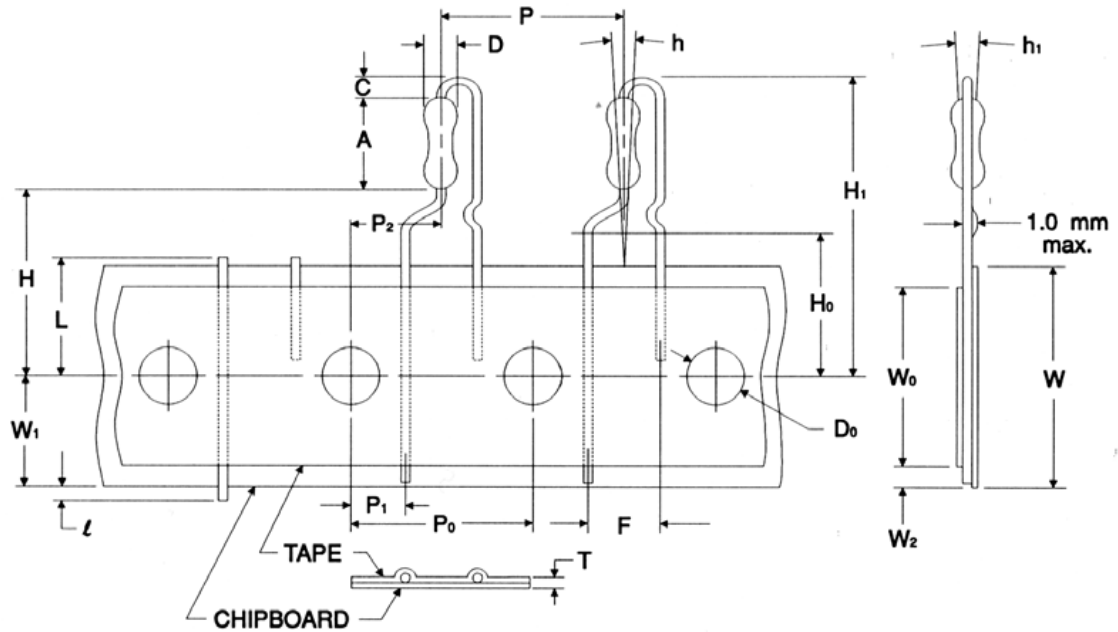

Description	Symbol	PANA-SERT	Units
Resistor body diameter	D	0.09 ± 0.008 2.3 ± 0.2	inches mm
Resistor body length	A	0.256 ± 0.02 6.5 ± 0.5	inches mm
Resistor pitch ¹	P	0.5 ± 0.039 12.7 ± 1	inches mm
Sprocket-hole pitch ¹	P ₀	0.5 ± 0.012 12.7 ± 0.3	inches mm
Sprocket-hole center to lead center	P ₁	0.152 ± 0.028 3.85 ± 0.7	inches mm
Sprocket-hole center to resistor center ¹	P ₂	0.25 ± 0.051 6.35 ± 1.3	inches mm
Resistor lead spacing	F	0.197 ± 0.039 5 ± 1	inches mm
Resistor alignment	h	0 ± 0.079 (0 ± 5°) 0 ± 2 (0 ± 5°)	inches mm
Chipboard width ¹	W	0.709 ± 0.039 / -0.02 18 ± 1 / -0.5	inches mm
Hold-down tape width	W ₀	0.492 12.5 min.	inches mm
Sprocket-hole position	W ₁	0.354 ± 0.03 / -0.02 9 ± 0.75 / 0.05	inches mm

Description	Symbol	PANA-SERT	Units
Hold-down tape position	W ₂	0.118 3 max	inches mm
Height to bottom of resistor	H	0.748 ± 0.039 19 ± 0.21	inches mm
Height to lead clinch	H ₀	0.63 ± 0.02 16 ± 0.5	inches mm
Lead protrusion	l	0.079 2 max.	inches mm
Sprocket-hole diameter	D ₀	0.157 ± 0.012 4 ± 0.3	inches mm
Thickness (chipboard and tape)	T	0.028 ± 0.008 0.7 ± 0.2	inches mm
Cutout Length ¹	L	0.433 11 max.	inches mm
Height of resistor	H ₁	1.122 28.5 max.	inches mm
Height of bending	C	0.098 ± 0.02 2.5 ± 0.5	inches mm
Resistor alignment	h ₁	0 ± 0.079 (0 ± 5°) 0 ± 2 (0 ± 5°)	inches mm

Note 1: Cumulative pitch tolerances not to exceed ±0.039 (±1) over 20 consecutive pitches. 2,500 pieces per reel
 Note 2: Product only available from 10Ω to 1MΩ in 5% or 1% tolerances.

Packaging & Identification Variations

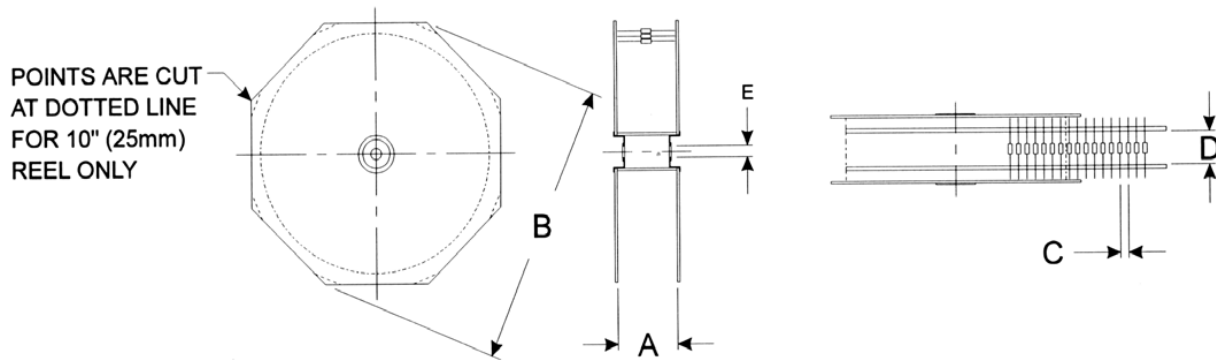

Lead Tape Specifications: Reeled in accordance with EIA-296-F

Series	Code	A max.		B max		C		D***		Tape		Class
		mm	inches	mm	inches	mm	inches	mm	inches	mm	inches	
ASR	1	99.5	3.92	343	13.5	10 ± 0.5	0.4 ± 0.02	53 +2 -1	2.08 +0.079 - 0.039	6.35	0.25	I
ASRM	1/4	63.7	2.51	343	13.5	5 ± 0.5	0.2 ± 0.02	53 +2 -1	2.08 +0.079 - 0.039	6.35	0.25	I
	1/2	66.5	2.62	343	13.5	5 ± 0.5	0.2 ± 0.02	53 +2 -1	2.08 +0.079 - 0.039	6.35	0.25	I
CD	1/8	63.7	2.51	343	13.5	5 ± 0.5	0.2 ± 0.02	53 +2 -1	2.08 +0.079 - 0.039	6.35	0.25	I
	1/4	66.5	2.62	343	13.5	5 ± 0.5	0.2 ± 0.02	53 +2 -1	2.08 +0.079 - 0.039	6.35	0.25	I
CF	1/2	69.5	2.74	343	13.5	5 ± 0.5	0.2 ± 0.02	53 +2 -1	2.08 +0.079 - 0.039	6.35	0.25	I
	1/8	63.7	2.51	343	13.5	5 ± 0.5	0.2 ± 0.02	53 +2 -1	2.08 +0.079 - 0.039	6.35	0.25	I
	1/4	67	2.64	343	13.5	5 ± 0.5	0.2 ± 0.02	53 +2 -1	2.08 +0.079 - 0.039	6.35	0.25	I
	1/2	69.5	2.74	343	13.5	5 ± 0.5	0.2 ± 0.02	53 +2 -1	2.08 +0.079 - 0.039	6.35	0.25	I
CFM	1	75.5	2.97	343	13.5	5 ± 0.5	0.2 ± 0.02	53 +2 -1	2.08 +0.079 - 0.039	6.35	0.25	I
	2	79.5	3.13	343	13.5	10 ± 0.5	0.4 ± 0.02	53 +2 -1	2.08 +0.079 - 0.039	6.35	0.25	I
FRN	1/4	63.7	2.51	343	13.5	5 ± 0.5	0.2 ± 0.02	53 +2 -1	2.08 +0.079 - 0.039	6.35	0.25	I
	1/2	67	2.64	343	13.5	5 ± 0.5	0.2 ± 0.02	53 +2 -1	2.08 +0.079 - 0.039	6.35	0.25	I
MR	1	84.1	3.31	343	13.5	5 ± 0.5	0.2 ± 0.02	53 +2 -1	2.08 +0.079 - 0.039	14.3	0.56	I
	3	88.5	3.49	343	13.5	10 ± 0.5	0.4 ± 0.02	53 +2 -1	2.08 +0.079 - 0.039	14.3	0.56	I
	5	97.8	3.85	343	13.5	10 ± 0.5	0.4 ± 0.02	53 +2 -1	2.08 +0.079 - 0.039	14.3	0.56	I
	10	121	4.76	343	13.5	10 ± 0.5	0.4 ± 0.02	53 +2 -1	2.08 +0.079 - 0.039	14.3	0.56	I
MWW	1	90.5	3.56	343	13.5	5 ± 0.5	0.2 ± 0.02	53 +2 -1	2.08 +0.079 - 0.039	14.3	0.56	I
	3	94.9	3.74	343	13.5	10 ± 0.5	0.4 ± 0.02	53 +2 -1	2.08 +0.079 - 0.039	14.3	0.56	I
	5	104	4.1	343	13.5	10 ± 0.5	0.4 ± 0.02	53 +2 -1	2.08 +0.079 - 0.039	14.3	0.56	I
	10	130	5.12	343	13.5	10 ± 0.5	0.4 ± 0.02	53 +2 -1	2.08 +0.079 - 0.039	14.3	0.56	I
RC	1/4	70.8	2.79	343	13.5	5 ± 0.5	0.2 ± 0.02	53 +2 -1	2.08 +0.079 - 0.039	14.3	0.56	I
	1/2	70	2.76	343	13.5	5 ± 0.5	0.2 ± 0.02	53 +2 -1	2.08 +0.079 - 0.039	14.3	0.56	I
	1	69.3	2.73	343	13.5	10 ± 0.5	0.4 ± 0.02	53 +2 -1	2.08 +0.079 - 0.039	14.3	0.56	I
RN	1/8	63.7	2.51	343	13.5	5 ± 0.5	0.2 ± 0.02	53 +2 -1	2.08 +0.079 - 0.039	14.3	0.56	I
	1/4	66.5	2.62	343	13.5	5 ± 0.5	0.2 ± 0.02	53 +2 -1	2.08 +0.079 - 0.039	14.3	0.56	I
	1/2	69.5	2.74	343	13.5	5 ± 0.5	0.2 ± 0.02	53 +2 -1	2.08 +0.079 - 0.039	14.3	0.56	I
	1	75.5	2.97	343	13.5	5 ± 0.5	0.2 ± 0.02	53 +2 -1	2.08 +0.079 - 0.039	14.3	0.56	I
RNM	1/4	63.7	2.51	343	13.5	5 ± 0.5	0.2 ± 0.02	53 +2 -1	2.08 +0.079 - 0.039	14.3	0.56	I
	1/2	66.5	2.62	343	13.5	5 ± 0.5	0.2 ± 0.02	53 +2 -1	2.08 +0.079 - 0.039	14.3	0.56	I

Dimension "E": This is a non-critical dimension that does not have a tolerance in the standard.
Range of diameters is from 13.9mm (0.55") to 38.1mm (1.5").

Lead Tape Specifications: Reeled in accordance with EIA-296-F

Series	Code	A max.		B max		C		D***		Tape		Class
		mm	inches	mm	inches	mm	inches	mm	inches	mm	inches	
RS	1/2	69.5	2.74	343	13.5	5 ± 0.5	0.2 ± 0.02	53 +2 -1	2.08 +0.079 - 0.039	14.3	0.56	I
	1	71.5	2.82	343	13.5	5 ± 0.5	0.2 ± 0.02	53 +2 -1	2.08 +0.079 - 0.039	14.3	0.56	I
	2**	89.5	3.53	343	13.5	10 ± 0.5	0.4 ± 0.02	63 ± 2	2.48 ± 0.079	14.3	0.56	II
	3	99.5	3.92	343	13.5	10 ± 0.5	0.4 ± 0.02	63 ± 2	2.48 ± 0.079	14.3	0.56	II
RSM	1/2	66.5	2.62	343	13.5	5 ± 0.5	0.2 ± 0.02	53 +2 -1	2.08 +0.079 - 0.039	14.3	0.56	I
	1	69.5	2.74	343	13.5	5 ± 0.5	0.2 ± 0.02	53 +2 -1	2.08 +0.079 - 0.039	14.3	0.56	I
	2	71.5	2.82	343	13.5	5 ± 0.5	0.2 ± 0.02	53 +2 -1	2.08 +0.079 - 0.039	14.3	0.56	I
	3	89.5	3.53	343	13.5	10 ± 0.5	0.4 ± 0.02	63 ± 2	2.48 ± 0.079	14.3	0.56	II
RSPF	5**	99.5	3.92	343	13.5	10 ± 0.5	0.4 ± 0.02	63 ± 2	2.48 ± 0.079	14.3	0.56	III
	1/2	66.5	2.62	343	13.5	5 ± 0.5	0.2 ± 0.02	53 +2 -1	2.08 +0.079 - 0.039	14.3	0.56	I
	1	69.5	2.74	343	13.5	5 ± 0.5	0.2 ± 0.02	53 +2 -1	2.08 +0.079 - 0.039	14.3	0.56	I
	2	71.5	2.82	343	13.5	5 ± 0.5	0.2 ± 0.02	53 +2 -1	2.08 +0.079 - 0.039	14.3	0.56	I
RSPL	3	89.5	3.53	343	13.5	10 ± 0.5	0.4 ± 0.02	53 +2 -1	2.08 +0.079 - 0.039	14.3	0.56	I
	1/2	66.5	2.62	343	13.5	5 ± 0.5	0.2 ± 0.02	53 +2 -1	2.08 +0.079 - 0.039	14.3	0.56	I
	1	69.5	2.74	343	13.5	5 ± 0.5	0.2 ± 0.02	53 +2 -1	2.08 +0.079 - 0.039	14.3	0.56	I
	2	85.5	3.37	343	13.5	5 ± 0.5	0.2 ± 0.02	53 +2 -1	2.08 +0.079 - 0.039	14.3	0.56	I
SPR	3	89.5	3.53	343	13.5	10 ± 0.5	0.4 ± 0.02	53 +2 -1	2.08 +0.079 - 0.039	14.3	0.56	I
	1/2	69.5	2.74	343	13.5	5 ± 0.5	0.2 ± 0.02	53 +2 -1	2.08 +0.079 - 0.039	14.3	0.56	I
TMR	1	99.5	3.92	343	13.5	10 ± 0.5	0.4 ± 0.02	53 +2 -1	2.08 +0.079 - 0.039	14.3	0.56	I
	3	160	6.3	343	13.5	10 ± 0.5	0.4 ± 0.02	53 +2 -1	2.08 +0.079 - 0.039	14.3	0.56	I
WRF	5	168	6.62	343	13.5	10 ± 0.5	0.4 ± 0.02	53 +2 -1	2.08 +0.079 - 0.039	14.3	0.56	I
	1	71.5	2.82	343	13.5	10 ± 0.5	0.4 ± 0.02	53 +2 -1	2.08 +0.079 - 0.039	14.3	0.56	I
	2	76.5	3.01	343	13.5	10 ± 0.5	0.4 ± 0.02	53 +2 -1	2.08 +0.079 - 0.039	14.3	0.56	II
WW	3	76.5	3.01	343	13.5	10 ± 0.5	0.4 ± 0.02	63 ± 2	2.48 ± 0.079	14.3	0.56	II
	H	88.6	3.49	343	13.5	5 ± 0.5	0.2 ± 0.02	53 +2 -1	2.08 +0.079 - 0.039	14.3	0.56	I
	1	90.2	3.55	343	13.5	5 ± 0.5	0.2 ± 0.02	53 +2 -1	2.08 +0.079 - 0.039	14.3	0.56	I
	1A	91.4	3.6	343	13.5	5 ± 0.5	0.2 ± 0.02	53 +2 -1	2.08 +0.079 - 0.039	14.3	0.56	I
	2	90.2	3.55	343	13.5	5 ± 0.5	0.2 ± 0.02	53 +2 -1	2.08 +0.079 - 0.039	14.3	0.56	I
	2A	94.7	3.73	343	13.5	5 ± 0.5	0.2 ± 0.02	53 +2 -1	2.08 +0.079 - 0.039	14.3	0.56	I
	3	94.7	3.73	343	13.5	5 ± 0.5	0.2 ± 0.02	53 +2 -1	2.08 +0.079 - 0.039	14.3	0.56	I
	3A	93.4	3.68	343	13.5	10 ± 0.5	0.4 ± 0.02	53 +2 -1	2.08 +0.079 - 0.039	14.3	0.56	I
	4	98.5	3.88	343	13.5	10 ± 0.5	0.4 ± 0.02	53 +2 -1	2.08 +0.079 - 0.039	14.3	0.56	I
	5	103	4.06	343	13.5	10 ± 0.5	0.4 ± 0.02	53 +2 -1	2.08 +0.079 - 0.039	14.3	0.56	I
	7	107	4.21	343	13.5	10 ± 0.5	0.4 ± 0.02	53 +2 -1	2.08 +0.079 - 0.039	14.3	0.56	I
	7B	111	4.37	343	13.5	10 ± 0.5	0.4 ± 0.02	53 +2 -1	2.08 +0.079 - 0.039	14.3	0.56	I
10	126	4.96	343	13.5	10 ± 0.5	0.4 ± 0.02	53 +2 -1	2.08 +0.079 - 0.039	14.3	0.56	I	

* Reference value only. The "A" dimension shall be governed by the overall length of the taped component.

The distance between flanges shall be 0.059 inches (1.5 mm) to 0.315 (8 mm) greater than the overall component.

** Class II capable.

*** The given dimension "D" expresses the standard width spacing. A 26mm narrow spacing is available as option "N" packaging code.

Packaging Specifications

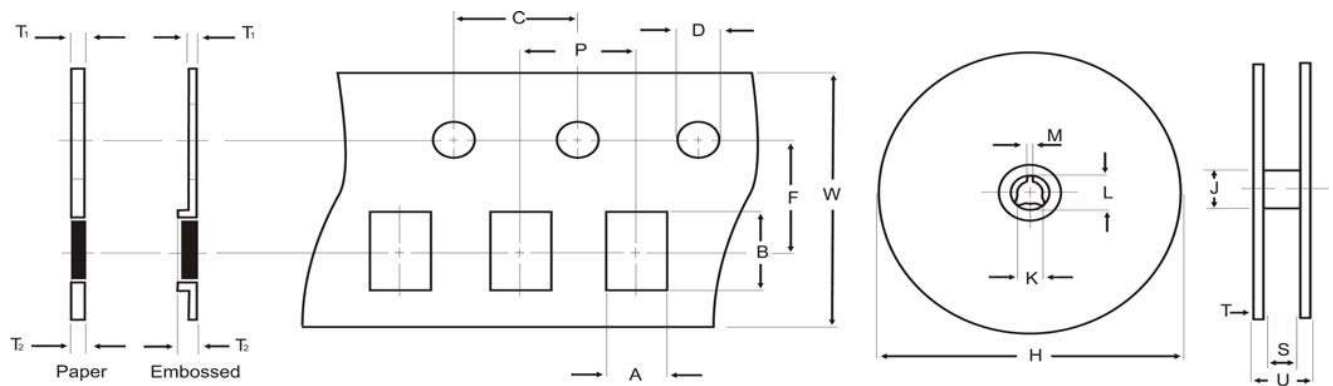

FEATURES	RAV 10-2D		RAV 10-4D		RAV 16-2D		RAV 16-4D & 32-8		RAV 32-4D	
	mm	inches	mm	inches	mm	inches	mm	inches	mm	inches
A - Pocket Width	0.046 ± 0.004	1.17 ± 0.1	0.051 ± 0.008	1.3 ± 0.2	0.071 ± 0.004	1.8 ± 0.1	0.079 ± 0.008	2 ± 0.2	0.134 ± 0.004	3.4 ± 0.1
B - Pocket Length	0.046 ± 0.004	1.17 ± 0.1	0.091 ± 0.008	2.3 ± 0.2	0.071 ± 0.004	1.8 ± 0.1	0.142 ± 0.008	3.6 ± 0.2	0.22 ± 0.004	5.6 ± 0.1
P - Pocket Spacing	0.079 ± 0.002	2 ± 0.05	0.079 ± 0.002	2 ± 0.05	0.157 ± 0.004	4 ± 0.1	0.157 ± 0.004	4 ± 0.1	0.157 ± 0.004	4 ± 0.1
C - Pin Spacing	0.157 ± 0.004	4 ± 0.1	0.157 ± 0.004	4 ± 0.1	0.157 ± 0.004	4 ± 0.1	0.157 ± 0.004	4 ± 0.1	0.157 ± 0.004	4 ± 0.1
D - Pin Diameter	0.06+0.004/-0	1.5 ± 0.1/-0	0.06 ± 0.004/-0	1.5+0.1/-0	0.06+0.004/-0	1.5+0.1/-0	0.06+0.004/-0	1.5+0.1/-0	0.06+0.004/-0	1+0.1/-0
F - Pin-Pocket C/L	0.138 ± 0.002	3.5 ± 0.05	0.138 ± 0.002	3.5 ± 0.05	0.138 ± 0.002	3.5 ± 0.05	0.138 ± 0.002	3.5 ± 0.05	0.217 ± 0.002	5.5 ± 0.05
W - Strip Width	0.315 ± 0.008	8 ± 0.2	0.315 ± 0.008	8 ± 0.2	0.315 ± 0.008	8 ± 0.2	0.315 ± 0.008	8 ± 0.2	0.472 ± 0.008	12 ± 0.2
T1 - Strip Thickness	0.04 max	1 max	0.04 max	1 max	0.02 max	0.5 max	0.04 max	1 max	0.01 ± 0.002	0.25 ± 0.05
T2 - Total Thickness	0.06 max	1.4 max	0.06 max	1.4 max	0.04 max	1 max	0.06 max	1.4 max	0.043 max	1.1 max
Material Pieces/Reel	Paper - 10,000		Paper - 10,000		Paper - 5,000		Paper - 5,000		Embossed - 4,000	
H - Reel Diameter	7 ± 0.08	178 ± 2	7 ± 0.08	178 ± 2	7 ± 0.08	178 ± 2	7 ± 0.08	178 ± 2	7.1+0/-0.12	180+0/-3
J - Hub Diameter	2	50	2	50	2	50	2	50	2.4 ± 0.04/-0	60 ± 1/-0
K - Hole Diameter	0.51 ± 0.04	13 ± 1	0.51 ± 0.04	13 ± 1	0.51 ± 0.04	13 ± 1	0.51 ± 0.04	13 ± 1	0.51 ± 0.01	13 ± 0.2
L - Key Diameter	0.83 ± 0.04	21 ± 1	0.83 ± 0.04	21 ± 1	0.83 ± 0.04	21 ± 1	0.83 ± 0.04	21 ± 1	0.83 ± 0.03	21 ± 0.8
M - Key Width	0.08 ± 0.04	2 ± 1	0.08 ± 0.04	2 ± 1	0.08 ± 0.04	2 ± 1	0.08 ± 0.04	2 ± 1	0.08 ± 0.02	2 ± 0.5
S - Reel Inside Width	0.53 ± 0.08	13.5 ± 2	0.53 ± 0.08	13.5 ± 2	0.53 ± 0.08	13.5 ± 2	0.53 ± 0.08	13.5 ± 2	0.35 ± 0.01	9 ± 0.3
T - Side Thickness	0.03 ± 0.01	0.8 ± 0.2	0.03 ± 0.01	0.8 ± 0.2	0.03 ± 0.01	0.8 ± 0.2	0.03 ± 0.01	0.8 ± 0.2	-	-
U - Reel Outside Width	-	-	-	-	-	-	-	-	0.45 ± 0.04	11.4 ± 1

Chip Resistor Reel

Nominal Dimensions
Inches (mm)

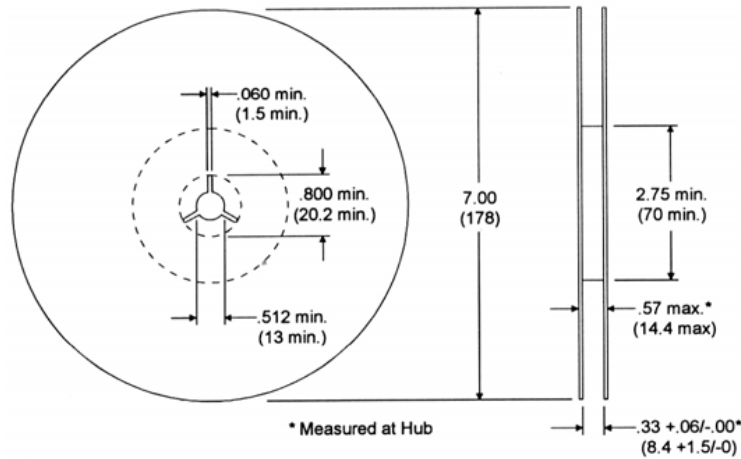

Packaging: Chips per EIA Standard RS-481

A	B	C	D	E	F	G	H	J ¹	inches mm
0.16 ± 0.01 4 ± 0.1	0.08 ± 0.01 2 ± 0.1	0.16 ± 0.01 4 ± 0.1	0.06 + 0.01/-0 1.5 + 0.1/-0	0.04 1	0.069 1.75	0.2 5	0.138 ± 0.002 3.5 ± 0.05	0.32 ± 0.01 8 ± 0.1	inches mm
			RGC 1/16, RMC 1/16, RNC 16, TTF 16, CSR 1/8		K1 0.04 max 1.1 max	K2 -	L 0.04 ± 0.01 1.1 ± 0.2	M 0.08 ± 0.01 1.9 ± 0.2	inches mm
			RGC 1/10, RMC 1/10, HMC 1/10, FCR 1/10, TTF 20, RNC 20, CSR 1/4		0.04 max 1.1 max	-	0.65 ± 0.008 1.65 ± 0.2	0.09 ± 0.01 2.4 ± 0.2	inches mm
			RGC 1/8, RMC 1/8, HMC 1/8, FCR 1/8, TTF 32, RNC 32, CSR 1/2		0.04 max 1.1 max	0.09 max 2.4 max	0.08 ± 0.01 2 ± 0.1	0.138 ± 0.002 3.5 ± 0.05	inches mm
			RMC 1/4, FCR 1/4		-	0.09 max 2.4 max	0.11 ± 0.01 2.8 ± 0.2	0.14 ± 0.01 3.6 ± 0.2	inches mm
			RMC 1/2, CSR 1		-	0.09 max 2.4 max	0.11 ± 0.01 2.8 ± 0.2	0.21 ± 0.01 5.3 ± 0.2	inches mm
			RMC 1, CSR 2		-	0.09 max 2.4 max	0.15 ± 0.01 3.8 ± 0.2	0.26 ± 0.01 6.6 ± 0.2	inches mm
			Notes:	1. Dimensions are 0.47 ± 0.01 (12 ± 0.1) for 2010 and 2512 size. 2. 5,000 per 7" reel - 0603, 0805 & 1206 size; 4,000 per 7" reel - 1210, 2010 & 2512 size. Available options - 10,000 piece 13" reels. 3. Embossed taping standard 4,000 per 7" reel on 1210, 2010 & 2512 size.					

Packaging: 0201 and 0402 Chip Size (2mm Pitch)

A	B	C	D	E	F	G	J	K	L	inches mm
0.026 + 0.004/-0.002 0.65 + 0.1/-0.05	0.045 + 0.004/-0.002 1.15 + 0.1/-0.05	0.315 ± 0.008 8 ± 0.2	0.138 ± 0.002 3.5 ± 0.05	0.69 ± 0.004 1.75 ± 0.1	0.079 ± 0.002 2 ± 0.05	0.39 ± 0.002 1 ± 0.05	0.059 + 0.004/-0 1.5 + 0.1/-0	0.016 + 0.002/-0 0.4 + 0.05/0	0.02 max 0.5 max	inches mm

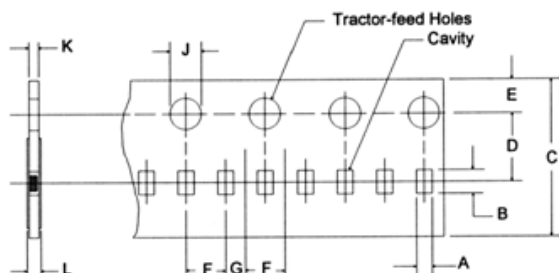

Standard Tape Packaging
2mm Pitch - 10,000 per reel
Reel diameter - 7 inches (178 mm)
Reel width - 0.315 inches (8 mm)

Packaging Specifications

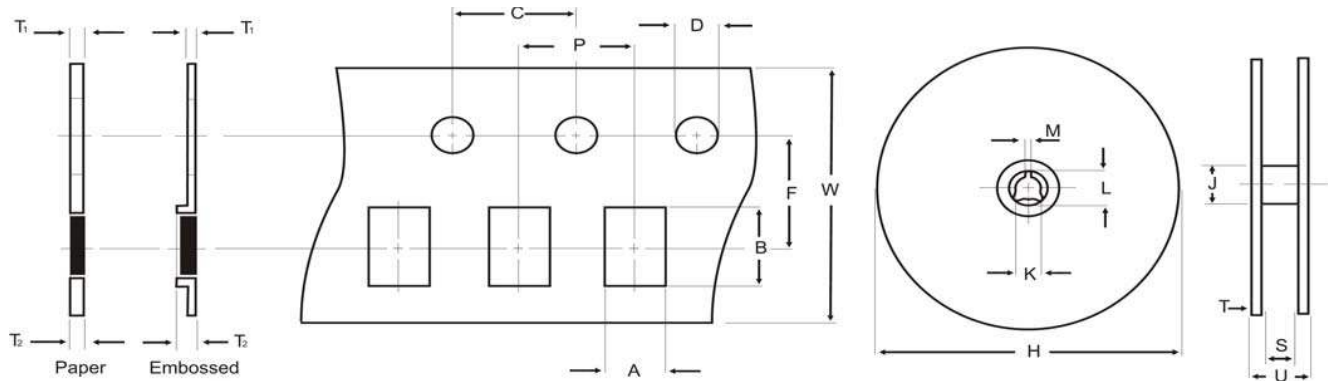

FEATURES	RAC 16-4D		RAC 32-4D		RAC40-8M		RAC64/8N/R	
	mm	inches	mm	inches	mm	inches	mm	inches
A - Pocket Width	0.079 ± 0.008	2 ± 0.2	0.138 ± 0.004	3.5 ± 0.1	0.098 ± 0.004	2.5 ± 0.1	0.138 ± 0.004	3.5 ± 0.1
B - Pocket Length	0.142 ± 0.008	3.6 ± 0.2	0.224 ± 0.004	5.7 ± 0.1	0.173 ± 0.004	4.4 ± 0.1	0.266 ± 0.004	6.75 ± 0.1
P - Pocket Spacing	0.157 ± 0.004	4 ± 0.01	0.157 ± 0.004	4 ± 0.1	0.157 ± 0.004	4 ± 0.1	0.157 ± 0.004	4 ± 0.1
C - Pin Spacing	0.157 ± 0.004	4 ± 0.1	0.157 ± 0.004	4 ± 0.1	0.157 ± 0.004	4 ± 0.1	0.157 ± 0.004	4 ± 0.1
D - Pin Diameter	0.06+0.004/-0	1.5+0.1/-0	0.06+0.004/-0	1+0.1/-0	0.06+0.004/-0	1.5+0.1/-0	0.06+0.004/-0	1.5+0.1/-0
F - Pin-to-Pocket Center	0.138 ± 0.002	3.5 ± 0.05	0.217 ± 0.002	5.5 ± 0.05	0.217 ± 0.002	5.5 ± 0.5	0.217 ± 0.002	5.5 ± 0.05
W - Strip Width	0.315 ± 0.008	8 ± 0.2	0.472 ± 0.008	12 ± 0.2	0.472 ± 0.008	12 ± 0.2	0.472 ± 0.008	12 ± 0.2
T1 - Strip Thickness	0.02 max	0.5 max	0.01 ± 0.002	0.25 ± 0.05	0.01 ± 0.002	0.25 ± 0.05	0.01 ± 0.002	0.25 ± 0.05
T2 - Total Thickness	0.04 max	1 max	0.043 max	1.1 max	0.043 max	1.1 max	0.043 max	1.1 max
Material Pieces/Reel	Paper - 5,000		Embossed - 4,000		Embossed - 4,000		Embossed - 4,000	
H - Reel Diameter	7 ± 0.08	178 ± 2	7.09+0/-0.12	180+0/-3	7.09+0/-0.12	180+0/-3	7.09+0/-0.12	180+0/-3
J - Hub Diameter	2	50	2.4+0.04/-0	60+1/-0	2.4+0.04/-0	60+1/-0	2.4+0.04/-0	60+1/-0
K - Hole Diameter	0.51 ± 0.04	13 ± 1	0.51 ± 0.01	13 ± 0.2	0.51 ± 0.01	13 ± 0.2	0.51 ± 0.01	13 ± 0.2
L - Key Diameter	0.83 ± 0.04	21 ± 1	0.83 ± 0.03	21 ± 0.8	0.83 ± 0.03	21 ± 0.8	0.83 ± 0.03	21 ± 0.8
M - Key Width	0.08 ± 0.04	2 ± 1	0.08 ± 0.02	2 ± 0.5	0.08 ± 0.02	2 ± 0.5	0.08 ± 0.02	2 ± 0.5
S - Reel Inside Width	0.53 ± 0.08	13.5 ± 2	0.35 ± 0.01	9 ± 0.3	0.35 ± 0.01	9 ± 0.3	0.35 ± 0.01	9 ± 0.3
T - Reel Side Thickness	0.03 ± 0.01	0.8 ± 0.2	-	-	-	-	-	-
U - Reel Outside Width	-	-	0.45 ± 0.04	11.4 ± 1	0.45 ± 0.04	11.4 ± 1	0.45 ± 0.04	11.4 ± 1

Packaging Specifications

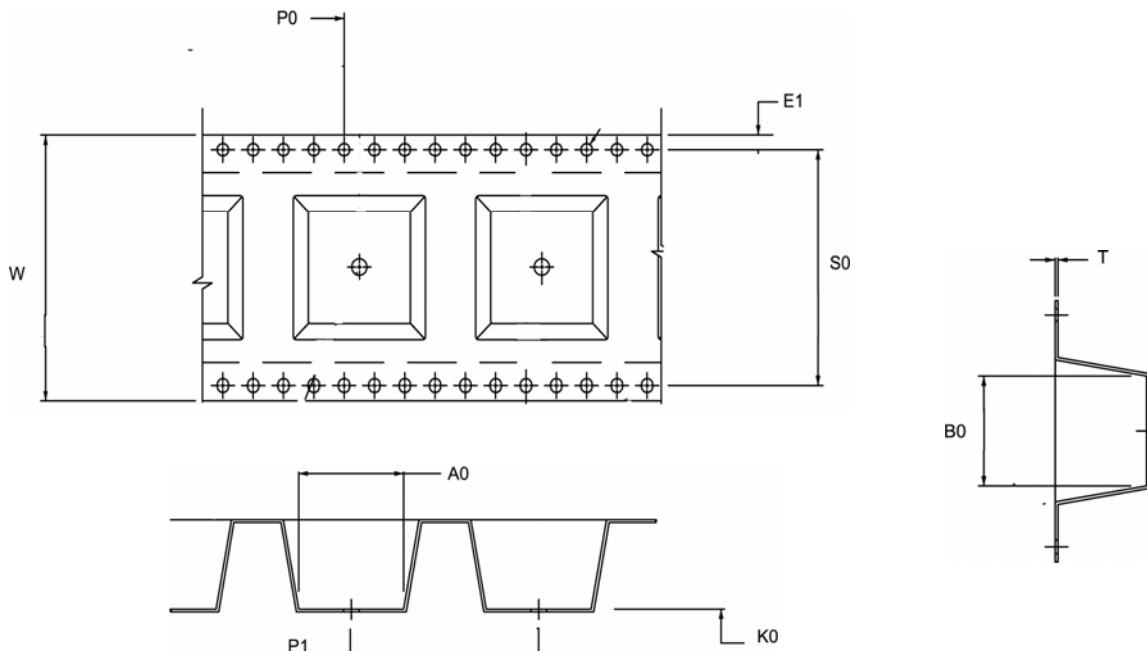

Packaging: HPC and SM										
Product Type	W	P ₀	E ₁	S ₀	P ₁	A ₀	K ₀	B ₀	T	inches mm
HPC	1.260 ± 0.012	0.157	0.069	1.118	0.945	0.529	0.440	0.529	0.018	inches
	32.00 ± 0.30	4.00	1.75	28.40	24.00	13.44	11.17	13.44	0.45	mm
SM1	0.63 +0.012 -0.004	0.157	0.069	-	0.315	0.161	0.159	0.302	0.018	inches
	16.00 +0.30 -0.10	4.00	1.75	-	8.00	4.10	4.03	7.66	0.45	mm
SM2	0.945 +0.012 -0.004	0.157	0.069	-	0.472	0.257	0.206	0.457	0.018	inches
	24.00 +0.30 -0.10	4.00	1.75	-	12.00	6.53	5.22	11.60	0.45	mm
SM3	1.26 ± 0.012	0.157	0.069	1.118	0.472	0.276	0.271	0.665	0.018	inches
	32.00 ± 0.30	4.00	1.75	28.40	12.00	7.01	6.88	16.89	0.45	mm
SM4	1.732 ± 0.012	0.157	0.069	1.591	0.630	0.343	0.396	0.856	0.018	inches
	44.00 ± 0.30	4.00	1.75	40.40	16.00	8.71	10.05	21.73	0.45	mm
SM4C	1.732 ± 0.012	0.157	0.069	1.591	0.630	0.395	0.423	0.837	0.018	inches
	44.00 ± 0.30	4.00	1.75	40.40	16.00	10.04	10.75	21.25	0.45	mm



1% Marking
The nominal resistance is marked on the surface of the overcoating with the use of 4 digit markings.
0201 and 0402 are not marked.

5% Marking
The nominal resistance is marked on the surface of the overcoating with the use of 3 digit markings.
0201 and 04402 are not marked.

For shared E24/E96 values, 1% tolerance product may be marked with three digit marking instead of the standard four digit marking for all other E96 values. All E24 values available in 1% tolerance are also marked with three digit marking.

Marking Instructions for 0603 1% Chip Resistors (per EIA-J)

A two-digit number is assigned to each standard R-Value (E96) as shown in the chart below. This is followed by one alpha character which is used as a multiplier. Each letter from "Y" - "F" represents a specific multiplier as follows:

Y = 0.1	B = 100	E = 100,000
X = 1	C = 1,000	F = 1,000,000
A = 10	D = 10,000	

EXAMPLE:

Chip Marking	Explanation	Value
01B	01 means 10.0 and B = 100	10.0 x 100 = 1 K ohm
25C	25 means 17.8 and C = 1,000	17.8 x 1,000 = 17.8 K ohm
93D	93 means 90.9 and D = 10,000	90.9 x 10,000 = 909 K ohm

E96											
1%	#	1%	#	1%	#	1%	#	1%	#	1%	#
10.0	01	14.7	17	21.5	33	31.6	49	46.4	65	68.1	81
10.2	02	15	18	22.1	34	32.4	50	47.5	66	69.8	82
10.6	03	15.4	19	22.6	35	33.2	51	48.7	67	71.5	83
10.7	04	15.8	20	23.2	36	34	52	49.9	68	73.2	84
11.0	05	16.2	21	23.7	37	34.8	53	51.1	69	75	85
11.3	06	16.5	22	24.3	38	35.7	54	52.3	70	76.8	86
11.6	07	16.9	23	24.9	39	36.5	55	53.6	71	78.7	87
11.8	08	17.4	24	25.5	40	37.4	56	54.9	72	80.6	88
12.1	09	17.8	25	26.1	41	38.3	57	56.2	73	82.5	89
12.4	10	18.2	26	26.7	42	39.2	58	57.6	74	84.5	90
12.7	11	18.7	27	27.4	43	40.2	59	59	75	86.6	91
13.0	12	19.1	28	28	44	41.2	60	60.4	76	88.7	92
13.3	13	19.6	29	28.7	45	42.2	61	61.9	77	90.9	93
13.7	14	20	30	29.4	46	43.2	62	63.4	78	93.1	94
14.0	15	20.5	31	30.1	47	44.2	63	64.9	79	95.3	95
14.3	16	21	32	30.9	48	45.3	64	66.5	80	97.6	96

Temperature Coefficient Codes			
Stackpole TC Code	MIL TC Code	Industry Std TC Code	Temperature Coefficient
T0	N/A	T0	±200 ppm/°C
T1	D	T1	±100 ppm/°C
T2	C	T2	±50 ppm/°C
T9	E	T9	±25 ppm/°C
TD	N/A	T10	±15 ppm/°C
TB	N/A	T13	±10 ppm/°C
TA	N/A	T16	±5 ppm/°C

Tolerance Codes		Resistance Values	
Stackpole/MIL Reference	Tolerance	Stackpole Standard for Nominal Values & Tolerances	
		Series	Tolerance
K	±10%	E12	±10%
J	±5%	E24	±5%, ±2%
G	±2%	E96	±1%
F	±1%	E192	±0.5%, ±0.25%, ±0.1%
D	±0.5%	Note: Non-standard Ω values are available. Consult factory for minimum order quantities	
C	±0.25%		
B	±0.1%		

Component Flammability					
Product Type	Polymer Type	IEC 695-2-2	UL94V Rating	Total Polymer Mass	Oxygen Index
Carbon Films					
CF 1/8 (CFM 1/4)	Epoxy	Meets Specification	N/A	3 mg	N/A
CF 1/4 (CFM 1/2)	Epoxy	Meets Specification	N/A	15 mg	N/A
CF 1/2	Epoxy	Meets Specification	N/A	30 mg	N/A
Metal Films					
RN 1/8 (RNM 1/4)	Epoxy	Meets Specification	N/A	3 mg	N/A
RN 1/4 (RNM 1/2)	Epoxy	Meets Specification	N/A	15 mg	N/A
RN 1/2	Epoxy	Meets Specification	N/A	30 mg	N/A
Metal Oxides					
RSM 1/2	Silicone	Meets Specification	94V-0	20 mg	46 - 48%
RSM 1 (RS 1/2)	Silicone	Meets Specification	94V-0	30 mg	46 - 48%
RSM 2 (RS 1)	Silicone	Meets Specification	94V-0	50 mg	46 - 48%
RSM 3 (RS 2)	Silicone	Meets Specification	94V-0	130 mg	46 - 48%
RSM 5 (RS 3)	Silicone	Meets Specification	94V-0	500 mg	46 - 48%
RS 5	Silicone		94V-0	400 mg	46 - 48%
Chip Resistors					
RMC Series	Boro-Silicated Acid Lead Glass	Meets Specification	94V-0	N/A	N/A
Resistor Networks					
LC5X	Epoxy	Meets Specification	94V-0	70 mg	N/A
LC6X	Epoxy	Meets Specification	94V-0	80 mg	N/A
LC7X	Epoxy	Meets Specification	94V-0	90 mg	N/A
LC8X	Epoxy	Meets Specification	94V-0	110 mg	N/A
LC9X	Epoxy	Meets Specification	94V-0	120 mg	N/A
LC0X	Epoxy	Meets Specification	94V-0	140 mg	N/A
Chip Networks					
RAC Series	Boro-Silicated Acid Lead Glass	Meets Specification	94V-0	N/A	N/A
RAV Series	Boro-Silicated Acid Lead Glass	Meets Specification	94V-0	N/A	N/A

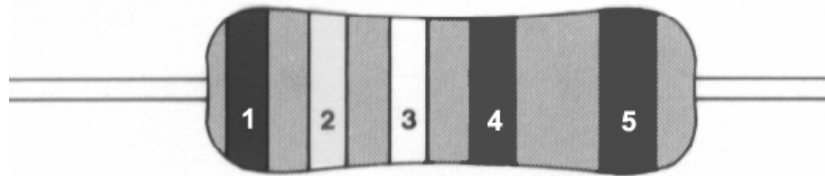

Standard Color Codes			
Band Color	Nominal	Multiplier	Tolerance (%)
Black	0	1	-
Brown	1	10	1
Red	2	100	2
Orange	3	1K	-
Yellow	4	10K	-
Green	5	100K	0.5
Blue	6	1,000K	0.25
Violet	7	-	-
Gray	8	-	-
White	9	0.001	-
Silver	-	0.01	10
Gold	-	0.1	5

Color Band Description		
Band	Precision	General Purpose
	Have three significant-figure bands, a multiplier band and a tolerance band. Tolerances 1% or less.	Have two significant-figure bands, a multiplier band and a tolerance band. Tolerances 2% or greater.
1st Band	Nominal	Nominal
2nd Band	Nominal	Nominal
3rd Band	Nominal	Multiplier
4th Band	Multiplier	Tolerance
5th Band	Tolerance	

Resistor Glossary	
Term	Definition
Ambient temperature	The ambient temperature is the temperature in the immediate environment of the resistor.
Carbon-composition	Resistor with the resistance element formed by molding a body of carbon powder mixed with a phenolic binder.
Carbon-film	Resistor whose resistance element is carbon film deposited on a ceramic core.
Climate category	Indicates the lowest and the highest ambient temperature at which the resistors may be operated continuously.
Color-band or color code	Method of indicating value and tolerance on axial leaded resistors whose body is too small for legible alphanumerical marking.
Critical resistance	The critical resistance (R_{crit}) is the resistance that can be calculated from the rated dissipation P_v occurring under operating voltage V_{max} . A resistor of critical resistance will exhibit the largest drift in a style, because it is the highest value that may carry the full rated power load.
Current noise	Random low frequency electrostatic noise arising from current fluctuations in parallel with the resistor.
Current sensor	A resistive device employed to sense levels of changes in current.
Derating	The power load capability of a resistor is limited by its permissible element temperature. Since the rated power dissipation is referenced to a specific ambient temperature, higher ambient temperatures require a reduced permissible load, i.e., a derating. The derating curve indicates the permissible power load as a function of the ambient temperature.
Dielectric strength (dielectric withstanding voltage)	The ultimate breakdown voltage of the dielectric or insulation of the resistor when the voltage is applied between the case and all terminals tied together. Dielectric strength is usually specified at sea level and simulated at high altitude air pressures.
DIP	Dual-in-line package resistor network.
E-series	Method of deriving nominal resistance values required for each tolerance level. The series E24 is comprised of 24 values per decade and applies to 2% and 5% tolerances. The series E96 applies to 1% tolerance and E192 applies to 0.1%, 0.25% and 0.5%.
Failure rate	The failure rate indicates the statistically established maximum rate of failures at a level of confidence of 60%. The figures are derived from certified results of standard endurance tests after 1000 hours duration at the rated dissipation.
Film temperature	The temperature of the resistive film is considered in discussions about power rating and pulse load capability. The film temperature determines the drift and stability of the resistor. For resistors that feature hot spots in the resistive film, the higher temperature of the hot spot is to be considered. Since most resistors are covered with lacquer or protective coating, only the surface temperature can be measured on the outside. However, the surface temperature is almost as high as the film temperature.
Fixed resistors	Resistors whose value is set in the manufacturing process.
Insulation resistance	The DC resistance measured between all terminals connected together and the case, exterior insulation, or external hardware.
Kelvin connection	Four-terminal connection required in low-resistance measurements to eliminate the effects of contact resistance and lead resistance, as well as the effects of lead temperature, providing accurate measurements. Invented by Lord Kelvin in the 19th Century.

Resistor Glossary	
Term	Definition
Maximum working voltage	The maximum voltage stress (DC or rms) that may be applied to the resistor (resistance element). A function of the materials used, the required performance, and the physical dimensions.
Metal oxide	Resistor whose resistance element is a thick film ruthenium oxide paste deposited on a cylindrical ceramic core by means of dipping or spiral-coating.
Operating voltage	The limiting element voltage V_{max} is the maximum voltage that may be applied continuously to the resistor, provided its resistance value is equal to or higher than the critical resistance. The limit applies to DC voltages and to AC rms voltage of undistorted sinusoidal shape.
Power rating	Maximum power in still air that will limit the resistor internal hot-spot temperature to a satisfactory level. Power ratings must be reduced as the temperature rises, so derating curves or charts are published. These parameters are application-dependent.
Pulse load capability	The pulse load capability of a resistor is its ability to withstand transient loads that considerably exceed the rated dissipation with its peak value.
Resistance temperature characteristic (coefficient)	The magnitude of change in resistance due to temperature, expressed in percent or degree centigrade or parts-per-million per degree centigrade (PPM/C). If the resistance changes are linear over the specified temperature range, the parameter is known as the temperature "coefficient". This assumption of linearity is usually made in order to ease calculations.
Resistance tolerance	The permissible deviation of the manufactured resistance value (express in percent) from the specified nominal resistance value at standard or stated environmental conditions.
Resistor	A device that converts electrical energy to thermal energy according to Ohm's Law.
Shunt	A resistive device employed to divert most of the current in an electric circuit.
SIP	Single-in-line package resistor network.
SMD	Surface mount devices. Chips and chip arrays are examples.
Solderability	Property of the termination to accept new solder in a soldering process.
Stability	Ability of a resistor to maintain its initial resistance value of extended periods of time when subjected to any combination of electrical stresses and environmental conditions.
Temperature rise	Thermal resistance that impedes the dissipation of heat from the resistor.
Thick-film	Resistor whose resistance element consists of a ruthenium oxide (also called cermet) screen printed onto a ceramic substrate and fired at a high temperature.
Variable resistors	Resistors whose value can be adjusted (trimmed) by the user, typically by means of a dial.
Voltage coefficient	A resistor has a voltage coefficient if measurements of resistance with different voltages yield different results. The voltage coefficient is the quotient of the relative difference in resistance and the difference of measuring voltage.
Wirewound	Resistor whose resistance element consists of a wire (nickel-chromium, copper-nickel, or gold-platinum) wound around a bobbin or core.
Zero-ohm resistors	Jumpers that are manufactured into resistor bodies for ease of insertion by the user.

EIA Standard Resistor Values

Codes for fixed resistors

STANDARD RESISTANCE VALUES FOR THE 10 TO 100 DECADE
(also usable in decade multiples or sub-multiples)

Resistance Tolerance (%)																								
E192	E96	E24	E12	E6	E192	E96	E24	E12	E6	E192	E96	E24	E12	E6	E192	E96	E24	E12	E6	E192	E96	E24	E12	E6
0.10%	1%	2%	10%	20%	0.10%	1%	2%	10%	20%	0.10%	1%	2%	10%	20%	0.10%	1%	2%	10%	20%	0.10%	1%	2%	10%	20%
0.25%	5%				0.25%	5%				0.25%	5%				0.25%	5%				0.25%	5%			
0.50%					0.50%					0.50%					0.50%					0.50%				
10.0	10.0	10	10	10	15.8	15.8	-	-	-	24.9	24.9	-	-	-	39.2	39.2	39	39	-	62.6	-	-	-	-
10.1	-	-	-	-	16.0	-	16	-	-	25.2	-	-	-	-	39.7	-	-	-	-	63.4	63.4	-	-	-
10.2	10.2	-	-	-	16.2	16.2	-	-	-	25.5	25.5	-	-	-	40.2	40.2	-	-	-	64.2	-	-	-	-
10.4	-	-	-	-	16.4	-	-	-	-	25.8	-	-	-	-	40.7	-	-	-	-	64.9	64.9	-	-	-
10.5	10.5	-	-	-	16.5	16.5	-	-	-	26.1	26.1	-	-	-	41.2	41.2	-	-	-	65.7	-	-	-	-
10.6	-	-	-	-	16.7	-	-	-	-	26.4	-	-	-	-	41.7	-	-	-	-	66.5	66.5	-	-	-
10.7	10.7	-	-	-	16.9	16.9	-	-	-	26.7	26.7	-	-	-	42.2	42.2	-	-	-	67.3	-	-	-	-
10.9	-	-	-	-	17.2	-	-	-	-	27.1	-	27	27	-	42.7	-	-	-	-	68.1	68.1	68	68	68
11.0	11.0	11	-	-	17.4	17.4	-	-	-	27.4	27.4	-	-	-	43.2	43.2	43	-	-	69.0	-	-	-	-
11.1	-	-	-	-	17.6	-	-	-	-	27.7	-	-	-	-	43.7	-	-	-	-	69.8	69.8	-	-	-
11.3	11.3	-	-	-	17.8	17.8	-	-	-	28.0	28.0	-	-	-	44.2	44.2	-	-	-	70.6	-	-	-	-
11.4	-	-	-	-	18.0	-	18	18	-	28.4	-	-	-	-	44.8	-	-	-	-	71.5	71.5	-	-	-
11.5	11.5	-	-	-	18.2	18.2	-	-	-	28.7	28.7	-	-	-	45.3	45.3	-	-	-	72.3	-	-	-	-
11.7	-	-	-	-	18.4	-	-	-	-	29.1	-	-	-	-	45.9	-	-	-	-	73.2	73.2	-	-	-
11.8	11.8	-	-	-	18.7	18.7	-	-	-	29.4	29.4	-	-	-	46.4	46.4	-	-	-	74.1	-	-	-	-
12.0	-	12	12	-	18.9	-	-	-	-	29.8	-	-	-	-	47.0	-	47	47	47	75.0	75.0	75	-	-
12.1	12.1	-	-	-	19.1	19.1	-	-	-	30.1	30.1	30	-	-	47.5	47.5	-	-	-	75.9	-	-	-	-
12.3	-	-	-	-	19.3	-	-	-	-	30.5	-	-	-	-	48.1	-	-	-	-	76.8	76.8	-	-	-
12.4	12.4	-	-	-	19.6	19.6	-	-	-	30.9	30.9	-	-	-	48.7	48.7	-	-	-	77.7	-	-	-	-
12.6	-	-	-	-	19.8	-	-	-	-	31.2	-	-	-	-	49.3	-	-	-	-	78.7	78.7	-	-	-
12.7	12.7	-	-	-	20.0	20.0	20	-	-	31.6	31.6	-	-	-	49.9	49.9	-	-	-	79.6	-	-	-	-
12.9	-	-	-	-	20.3	-	-	-	-	32.0	-	-	-	-	50.5	-	-	-	-	80.6	80.6	-	-	-
13.0	13.0	13	-	-	20.5	20.5	20	-	-	32.4	32.4	-	-	-	51.1	51.1	51	-	-	81.6	-	-	-	-
13.2	-	-	-	-	20.8	-	-	-	-	32.8	-	-	-	-	51.7	-	-	-	-	82.5	82.5	82	82	-
13.3	13.3	-	-	-	21.0	21.0	-	-	-	33.2	33.2	33	33	33	52.3	52.3	-	-	-	83.5	-	-	-	-
13.5	-	-	-	-	21.3	-	-	-	-	33.6	-	-	-	-	53.0	-	-	-	-	84.5	84.5	-	-	-
13.7	13.7	-	-	-	21.5	21.5	-	-	-	34.0	34.0	-	-	-	53.6	53.6	-	-	-	85.6	-	-	-	-
13.8	-	-	-	-	21.8	-	-	-	-	34.4	-	-	-	-	54.2	-	-	-	-	86.6	86.6	-	-	-
14.0	14.0	-	-	-	22.1	22.1	22	22	22	34.8	34.8	-	-	-	54.9	54.9	-	-	-	87.6	-	-	-	-
14.2	-	-	-	-	22.3	-	-	-	-	35.2	-	-	-	-	55.6	-	-	-	-	88.7	88.7	-	-	-
14.3	14.3	-	-	-	22.6	22.6	-	-	-	35.7	35.7	-	-	-	56.2	56.2	56	56	-	89.8	-	-	-	-
14.5	-	-	-	-	22.9	-	-	-	-	36.1	-	36	-	-	56.9	-	-	-	-	90.9	90.9	91	-	-
14.7	14.7	-	-	-	23.2	23.2	-	-	-	36.5	36.5	-	-	-	57.6	57.6	-	-	-	92.0	-	-	-	-
14.9	-	-	-	-	23.4	-	-	-	-	37.0	-	-	-	-	58.3	-	-	-	-	93.1	93.1	-	-	-
15.0	15.0	15	15	15	23.7	23.7	-	-	-	37.4	37.4	-	-	-	59.0	59.0	-	-	-	94.2	-	-	-	-
15.2	-	-	-	-	24.0	-	24	-	-	37.9	-	-	-	-	59.7	-	-	-	-	95.3	95.3	-	-	-
15.4	15.4	-	-	-	24.3	24.3	-	-	-	38.3	38.3	-	-	-	60.4	60.4	-	-	-	96.5	-	-	-	-
15.6	-	-	-	-	24.6	-	-	-	-	38.8	-	-	-	-	61.2	-	-	-	-	97.6	97.6	-	-	-
															61.9	61.9	62	-	-	98.8	-	-	-	-