

MBRB3030CTLG, NRVBB3030CTLG

Switch-mode Power Rectifier

These state-of-the-art devices use the Schottky Barrier principle with a proprietary barrier metal.

Features

- Dual Diode Construction, May be Paralleled for Higher Current Output
- Guard-Ring for Stress Protection
- Low Forward Voltage Drop
- 125°C Operating Junction Temperature
- Maximum Die Size
- Short Heat Sink Tab Manufactured – Not Sheared!
- AEC-Q101 Qualified and PPAP Capable
- NRVBB Prefix for Automotive and Other Applications Requiring Unique Site and Control Change Requirements
- All Packages are Pb-Free*

Mechanical Characteristics

- Case: Epoxy, Molded, Epoxy Meets UL 94 V-0
- Weight: 1.7 Grams (Approximately)
- Finish: All External Surfaces Corrosion Resistant and Terminal Leads are Readily Solderable
- Lead and Mounting Surface Temperature for Soldering Purposes: 260°C Max. for 10 Seconds
- Device Meets MSL1 Requirements
- ESD Ratings:
 - ◆ Machine Model = C (> 400 V)
 - ◆ Human Body Model = 3B (> 8000 V)



ON Semiconductor®

<http://onsemi.com>

**SCHOTTKY BARRIER
RECTIFIER
30 AMPERES, 30 VOLTS**

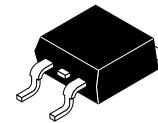

**D²PAK
CASE 418B
PLASTIC**

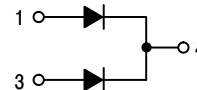

MARKING DIAGRAM



A = Assembly Location
Y = Year
WW = Work Week
B3030CTL = Device Code
G = Pb-Free Package
AKA = Diode Polarity

ORDERING INFORMATION

Device	Package	Shipping [†]
MBRB3030CTLG	D ² PAK (Pb-Free)	50 Units / Rail
NRVBB3030CTLG	D ² PAK (Pb-Free)	50 Units / Rail
NRVBB3030CTLT4G	D ² PAK (Pb-Free)	800 / Tape & Reel

[†]For information on tape and reel specifications, including part orientation and tape sizes, please refer to our Tape and Reel Packaging Specifications Brochure, BRD8011/D.

*For additional information on our Pb-Free strategy and soldering details, please download the ON Semiconductor Soldering and Mounting Techniques Reference Manual, SOLDERRM/D.

MBRB3030CTLG, NRVBB3030CTLG

MAXIMUM RATINGS

Rating	Symbol	Value	Unit
Peak Repetitive Reverse Voltage Working Peak Reverse Voltage DC Blocking Voltage	V_{RRM} V_{RWM} V_R	30	V
Average Rectified Forward Current (At Rated V_R , $T_C = 115^\circ\text{C}$) Per Device	I_O	15 30	A
Peak Repetitive Forward Current (At Rated V_R , Square Wave, 20 kHz, $T_C = 115^\circ\text{C}$)	I_{FRM}	30	A
Non-Repetitive Peak Surge Current (Surge Applied at Rated Load Conditions Halfwave, Single Phase, 60 Hz)	I_{FSM}	300	A
Peak Repetitive Reverse Surge Current (1.0 μs , 1.0 kHz)	I_{RRM}	2.0	A
Storage Temperature Range	T_{stg}	-55 to +150	$^\circ\text{C}$
Operating Junction Temperature Range	T_J	-55 to +125	$^\circ\text{C}$
Voltage Rate of Change (Rated V_R , $T_J = 25^\circ\text{C}$)	dV/dt	10,000	V/ μs
Reverse Energy, Unclamped Inductive Surge ($T_J = 25^\circ\text{C}$, L = 3.0 mH)	E_{AS}	224.5	mJ

Stresses exceeding Maximum Ratings may damage the device. Maximum Ratings are stress ratings only. Functional operation above the Recommended Operating Conditions is not implied. Extended exposure to stresses above the Recommended Operating Conditions may affect device reliability.

THERMAL CHARACTERISTICS (All device data is "Per Leg" except where noted.)

Characteristic	Symbol	Value	Unit
Thermal Resistance, Junction-to-Ambient (Note 1)	$R_{\theta JA}$	50	$^\circ\text{C}/\text{W}$
Thermal Resistance, Junction-to-Case	$R_{\theta JC}$	1.0	$^\circ\text{C}/\text{W}$

1. Mounted using minimum recommended pad size on FR-4 board.

ELECTRICAL CHARACTERISTICS

Characteristic	Symbol	Value	Unit
Maximum Instantaneous Forward Voltage (Note 2) ($I_F = 15\text{ A}$, $T_J = 25^\circ\text{C}$) ($I_F = 30\text{ A}$, $T_J = 25^\circ\text{C}$)	V_F	0.44 0.51	V
Maximum Instantaneous Reverse Current (Note 2) (Rated V_R , $T_J = 25^\circ\text{C}$) (Rated V_R , $T_J = 125^\circ\text{C}$)	I_R	2.0 195	mA

2. Pulse Test: Pulse Width = 250 μs , Duty Cycle $\leq 2.0\%$.

MBRB3030CTLG, NRVBB3030CTLG

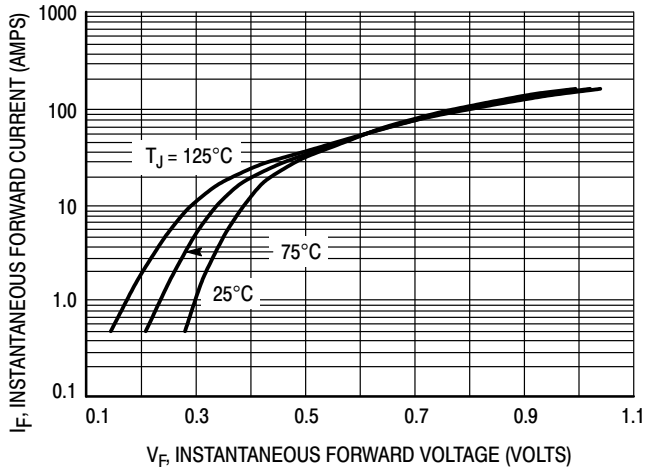

Figure 1. Typical Forward Voltage

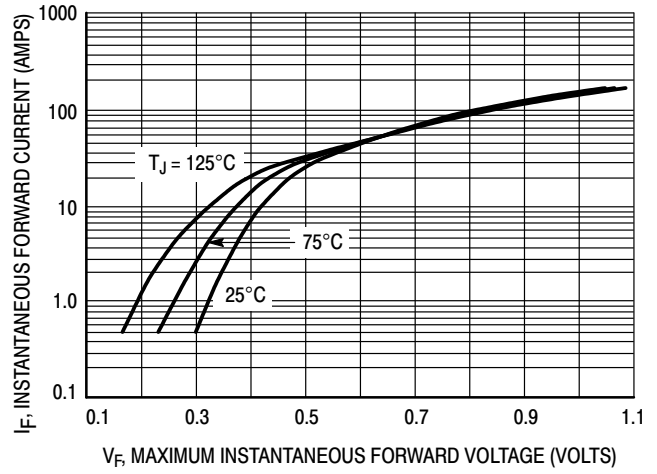

Figure 2. Maximum Forward Voltage

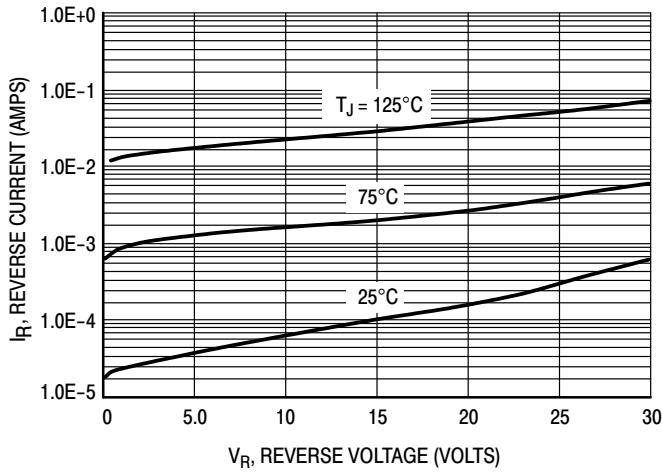

Figure 3. Typical Reverse Current

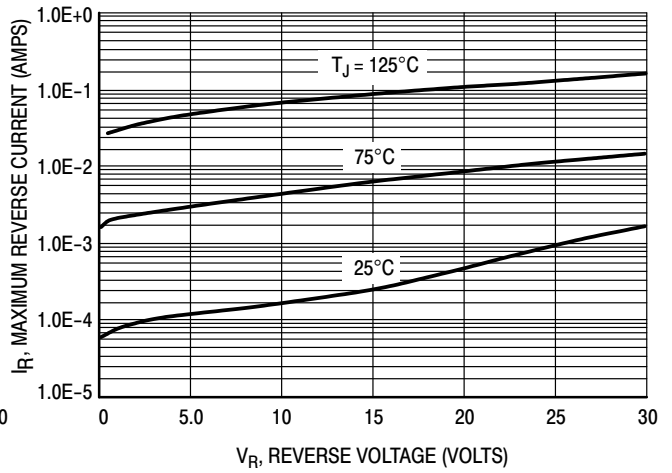

Figure 4. Maximum Reverse Current

MBRB3030CTLG, NRVBB3030CTLG

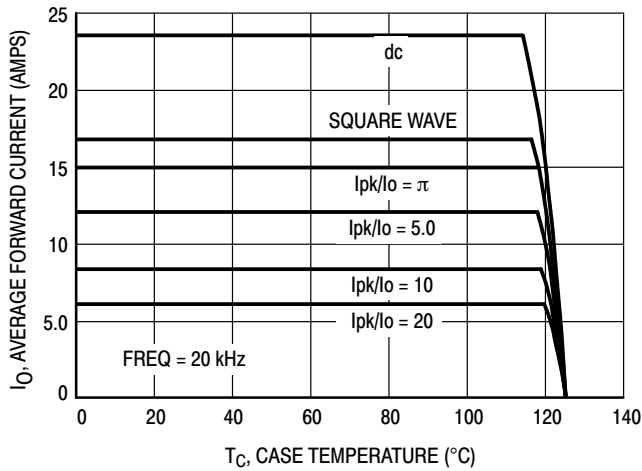

Figure 5. Current Derating

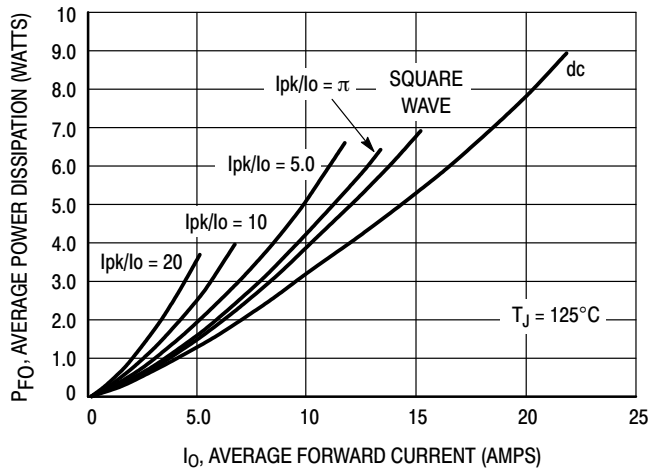

Figure 6. Forward Power Dissipation

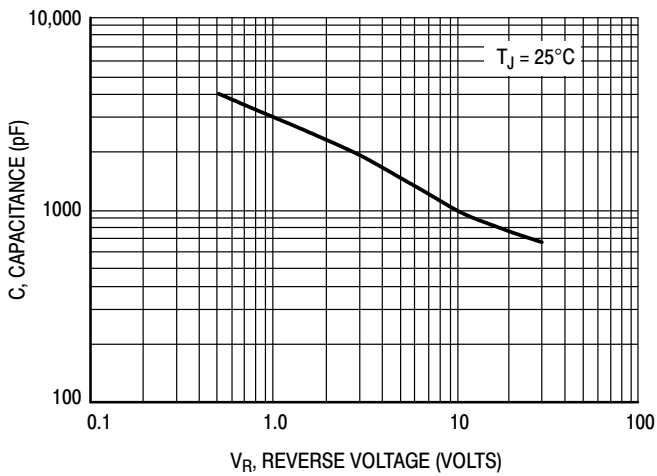

Figure 7. Typical Capacitance

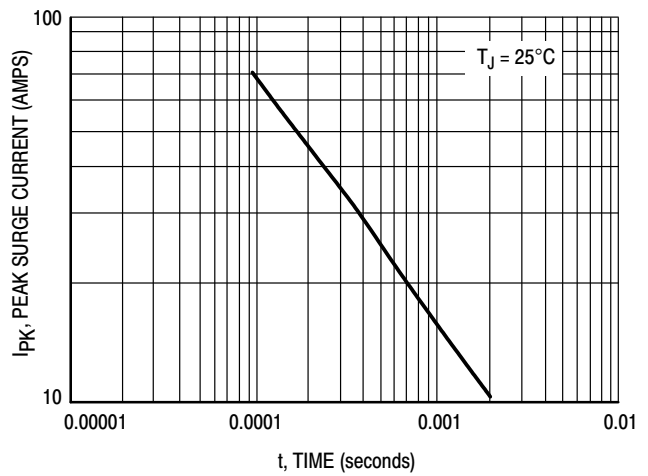

Figure 8. Typical Unclamped Inductive Surge

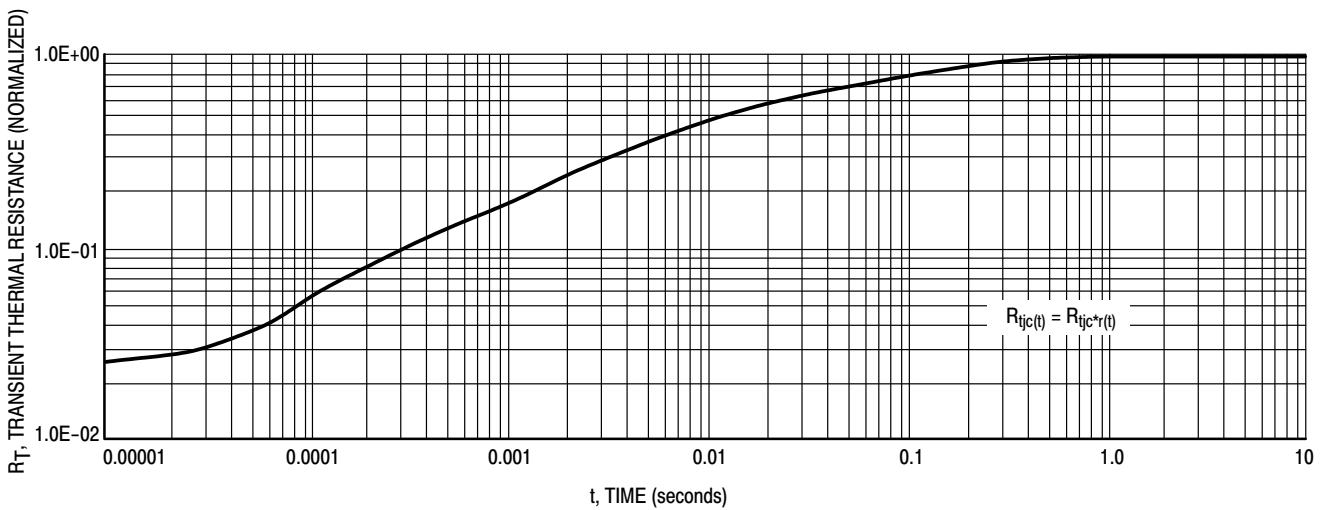

Figure 9. Typical Thermal Response

Modeling Reverse Energy Characteristics of Power Rectifiers

ABSTRACT

Power semiconductor rectifiers are used in a variety of applications where the reverse energy requirements often vary dramatically based on the operating conditions of the application circuit. A characterization method was devised using the Unclamped Inductive Surge (UIS) test technique. By testing at only a few different operating conditions (i.e. different inductor sizes) a safe operating range can be established for a device. A relationship between peak avalanche current and inductor discharge time was established. Using this relationship and circuit parameters, the part applicability can be determined. This technique offers a power supply designer the total operating conditions for a device as opposed to the present single-data-point approach.

INTRODUCTION

In today's modern power supplies, converters and other switching circuitry, large voltage spikes due to parasitic inductance can propagate throughout the circuit, resulting in catastrophic device failures. Concurrent with this, in an effort to provide low-loss power rectifiers, i.e., devices with lower forward voltage drops, Schottky technology is being

applied to devices used in this switching power circuitry. This technology lends itself to lower reverse breakdown voltages. This combination of high voltage spikes and low reverse breakdown voltage devices can lead to reverse energy destruction of power rectifiers in their applications. This phenomena, however, is not limited to just Schottky technology.

In order to meet the challenges of these situations, power semiconductor manufacturers attempt to characterize their devices with respect to reverse energy robustness. The typical reverse energy specification, if provided at all, is usually given as energy-to-failure (mJ) with a particular inductor specified for the UIS test circuit. Sometimes the peak reverse test current is also specified. Practically all reverse energy characterizations are performed using the UIS test circuit shown in Figure 10. Typical UIS voltage and current waveforms are shown in Figure 11.

In order to provide the designer with a more extensive characterization than the above mentioned one-point approach, a more comprehensive method for characterizing these devices was developed. A designer can use the given information to determine the appropriateness and safe operating area (SOA) of the selected device.

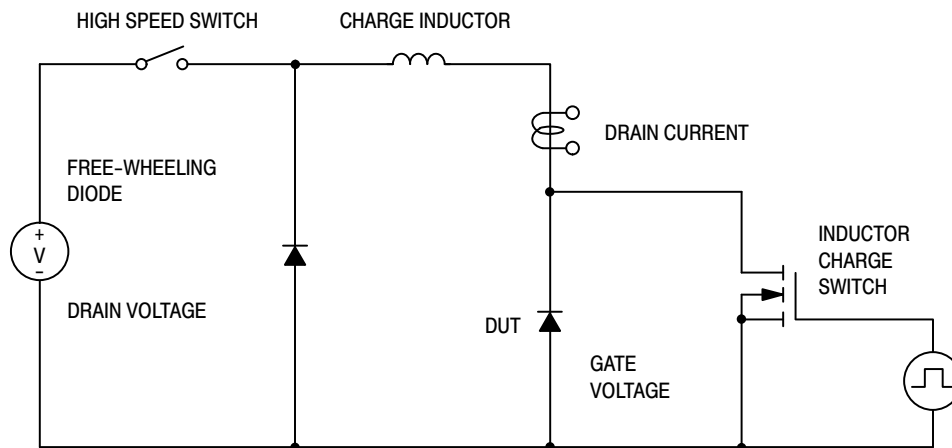

Figure 10. Simplified UIS Test Circuit

Suggested Method of Characterization

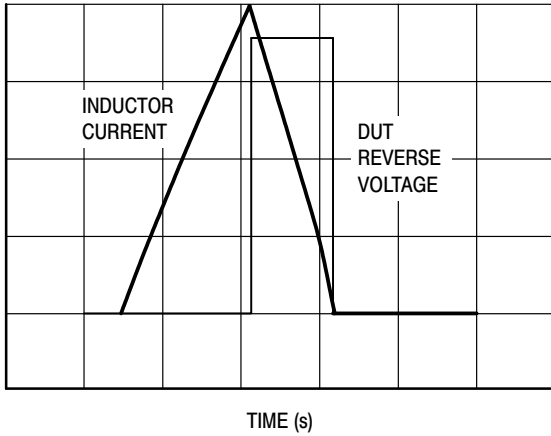

Figure 11. Typical Voltage and Current UIS Waveforms

Utilizing the UIS test circuit in Figure 10, devices are tested to failure using inductors ranging in value from 0.01 to 159 mH. The reverse voltage and current waveforms are acquired to determine the exact energy seen by the device and the inductive current decay time. At least 4 distinct inductors and 5 to 10 devices per inductor are used to generate the characteristic current versus time relationship. This relationship when coupled with the application circuit conditions, defines the SOA of the device uniquely for this application.

Example Application

The device used for this example was an MBR3035CT, which is a 30 A (15 A per side) forward current, 35 V reverse breakdown voltage rectifier. All parts were tested to destruction at 25°C. The inductors used for the characterization were 10, 3.0, 1.0 and 0.3 mH. The data recorded from the testing were peak reverse current (I_p), peak reverse breakdown voltage (BVR), maximum withstand energy, inductance and inductor discharge time (see Table 1). A plot of the Peak Reverse Current versus Time at device destruction, as shown in Figure 12, was generated. The area under the curve is the region of lower reverse energy or lower stress on the device. This area is known as the safe operating area or SOA.

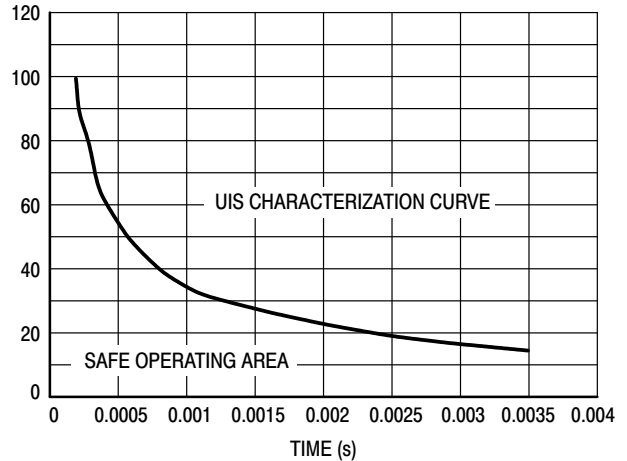

Figure 12. Peak Reverse Current versus Time for DUT

MBRB3030CTLG, NRVBB3030CTLG

Table 1. UIS Test Data

PART NO.	I _p (A)	B _{Vr} (V)	ENERGY (mJ)	L (mH)	TIME (μs)
1	46.6	65.2	998.3	1	715
2	41.7	63.4	870.2	1	657
3	46.0	66.0	1038.9	1	697
4	42.7	64.8	904.2	1	659
5	44.9	64.8	997.3	1	693
6	44.1	64.1	865.0	1	687
7	26.5	63.1	1022.6	3	1261
8	26.4	62.8	1024.9	3	1262
9	24.4	62.2	872.0	3	1178
10	27.6	62.9	1091.0	3	1316
11	27.7	63.2	1102.4	3	1314
12	17.9	62.6	1428.6	10	2851
13	18.9	62.1	1547.4	10	3038
14	18.8	60.7	1521.1	10	3092
15	19.0	62.6	1566.2	10	3037
16	74.2	69.1	768.4	0.3	322
17	77.3	69.6	815.4	0.3	333
18	75.2	68.9	791.7	0.3	328
19	77.3	69.6	842.6	0.3	333
20	73.8	69.1	752.4	0.3	321
21	75.6	69.2	823.2	0.3	328
22	74.7	68.6	747.5	0.3	327
23	78.4	70.3	834.0	0.3	335
24	70.5	66.6	678.4	0.3	317
25	78.3	69.4	817.3	0.3	339

The procedure to determine if a rectifier is appropriate, from a reverse energy standpoint, to be used in the application circuit is as follows:

- Obtain “Peak Reverse Current versus Time” curve from data book.
- Determine steady state operating voltage (OV) of circuit.
- Determine parasitic inductance (L) of circuit section of interest.
- Obtain rated breakdown voltage (BVR) of rectifier from data book.
- From the following relationships,

$$V = L \cdot \frac{di(t)}{dt} \quad I = \frac{(BVR - OV) \cdot t}{L}$$

a “designer” I versus t curve is plotted alongside the device characteristic plot.

- The point where the two curves intersect is the current level where the devices will start to fail. A peak inductor current below this intersection should be chosen for safe operating.

As an example, the values were chosen as L = 200 μH, OV = 12 V and BVR = 35 V.

Figure 13 illustrates the example. Note the UIS characterization curve, the parasitic inductor current curve and the safe operating region as indicated.

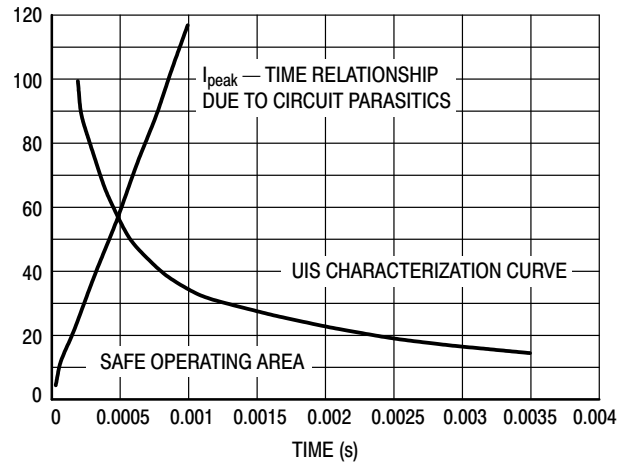

Figure 13. DUT Peak Reverse and Circuit Parasitic Inductance Current versus Time

SUMMARY

Traditionally, power rectifier users have been supplied with single–data–point reverse–energy characteristics by the supplier’s device data sheet; however, as has been shown here and in previous work, the reverse withstand energy can vary significantly depending on the application. What was done in this work was to create a characterization scheme by which the designer can overlay or map their particular requirements onto the part capability and determine quite accurately if the chosen device is applicable. This characterization technique is very robust due to its statistical approach, and with proper guardbanding (6σ) can be used to give worst–case device performance for the entire product line. A “typical” characteristic curve is probably the most applicable for designers allowing them to design in their own margins.

References

- Borras, R., Aliosi, P., Shumate, D., 1993, “Avalanche Capability of Today’s Power Semiconductors,” “Proceedings, European Power Electronic Conference,” 1993, Brighton, England
- Pshaenich, A., 1985, “Characterizing Overvoltage Transient Suppressors,” Powerconversion International, June/July

MECHANICAL CASE OUTLINE

PACKAGE DIMENSIONS

ON Semiconductor®

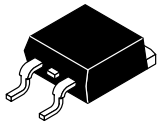

D²PAK 3
CASE 418B-04
ISSUE L

DATE 17 FEB 2015

SCALE 1:1

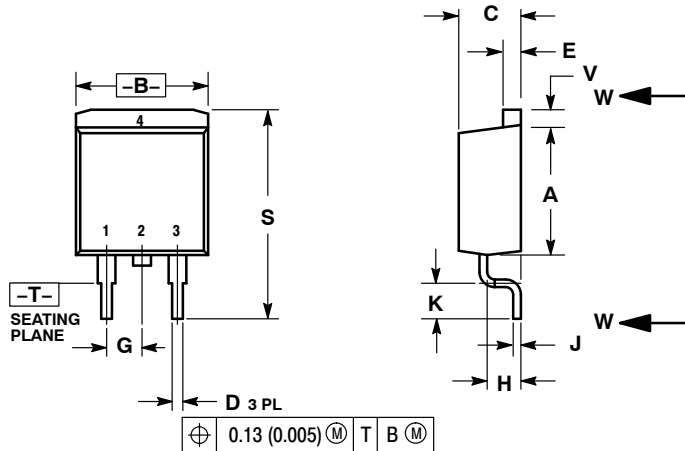

NOTES:

1. DIMENSIONING AND TOLERANCING PER ANSI Y14.5M, 1982.
2. CONTROLLING DIMENSION: INCH.
3. 418B-01 THRU 418B-03 OBSOLETE, NEW STANDARD 418B-04.

DIM	INCHES		MILLIMETERS	
	MIN	MAX	MIN	MAX
A	0.340	0.380	8.64	9.65
B	0.380	0.405	9.65	10.29
C	0.160	0.190	4.06	4.83
D	0.020	0.035	0.51	0.89
E	0.045	0.055	1.14	1.40
F	0.310	0.350	7.87	8.89
G	0.100	BSC	2.54	BSC
H	0.080	0.110	2.03	2.79
J	0.018	0.025	0.46	0.64
K	0.090	0.110	2.29	2.79
L	0.052	0.072	1.32	1.83
M	0.280	0.320	7.11	8.13
N	0.197	REF	5.00	REF
P	0.079	REF	2.00	REF
R	0.039	REF	0.99	REF
S	0.575	0.625	14.60	15.88
V	0.045	0.055	1.14	1.40

VARIABLE CONFIGURATION ZONE

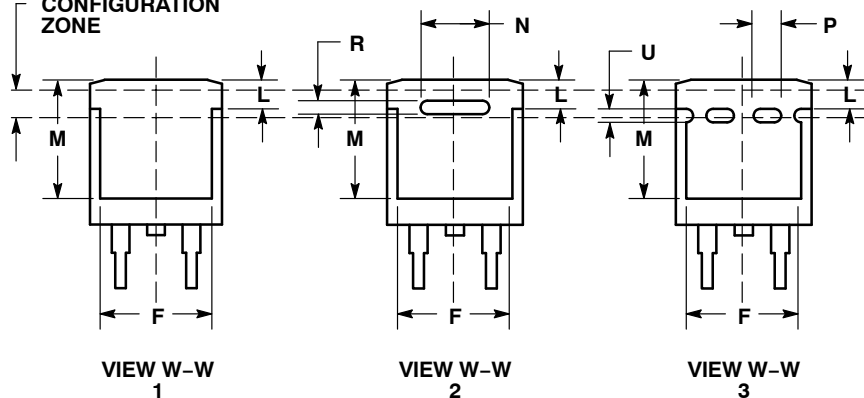

- | | | | | | |
|--|---|---|--|---|--|
| STYLE 1:
PIN 1. BASE
2. COLLECTOR
3. EMITTER
4. COLLECTOR | STYLE 2:
PIN 1. GATE
2. DRAIN
3. SOURCE
4. DRAIN | STYLE 3:
PIN 1. ANODE
2. CATHODE
3. ANODE
4. CATHODE | STYLE 4:
PIN 1. GATE
2. COLLECTOR
3. EMITTER
4. COLLECTOR | STYLE 5:
PIN 1. CATHODE
2. ANODE
3. CATHODE
4. ANODE | STYLE 6:
PIN 1. NO CONNECT
2. CATHODE
3. ANODE
4. CATHODE |
|--|---|---|--|---|--|

MARKING INFORMATION AND FOOTPRINT ON PAGE 2

DOCUMENT NUMBER:	98ASB42761B	Electronic versions are uncontrolled except when accessed directly from the Document Repository. Printed versions are uncontrolled except when stamped "CONTROLLED COPY" in red.
DESCRIPTION:	D²PAK 3	PAGE 1 OF 2

ON Semiconductor and are trademarks of Semiconductor Components Industries, LLC dba ON Semiconductor or its subsidiaries in the United States and/or other countries. ON Semiconductor reserves the right to make changes without further notice to any products herein. ON Semiconductor makes no warranty, representation or guarantee regarding the suitability of its products for any particular purpose, nor does ON Semiconductor assume any liability arising out of the application or use of any product or circuit, and specifically disclaims any and all liability, including without limitation special, consequential or incidental damages. ON Semiconductor does not convey any license under its patent rights nor the rights of others.

D²PAK 3
CASE 418B-04
ISSUE L

DATE 17 FEB 2015

**GENERIC
MARKING DIAGRAM***

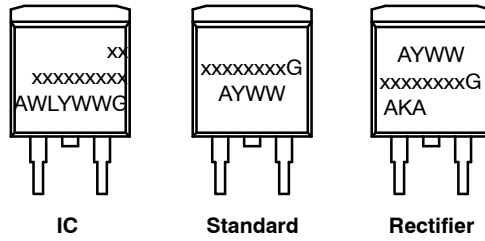

- xx = Specific Device Code
- A = Assembly Location
- WL = Wafer Lot
- Y = Year
- WW = Work Week
- G = Pb-Free Package
- AKA = Polarity Indicator

*This information is generic. Please refer to device data sheet for actual part marking. Pb-Free indicator, "G" or microdot "▪", may or may not be present.

SOLDERING FOOTPRINT*

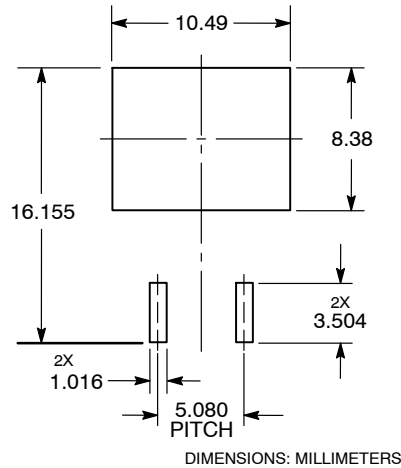

*For additional information on our Pb-Free strategy and soldering details, please download the ON Semiconductor Soldering and Mounting Techniques Reference Manual, SOLDERRM/D.

DOCUMENT NUMBER:	98ASB42761B	Electronic versions are uncontrolled except when accessed directly from the Document Repository. Printed versions are uncontrolled except when stamped "CONTROLLED COPY" in red.
DESCRIPTION:	D²PAK 3	PAGE 2 OF 2

ON Semiconductor and are trademarks of Semiconductor Components Industries, LLC dba ON Semiconductor or its subsidiaries in the United States and/or other countries. ON Semiconductor reserves the right to make changes without further notice to any products herein. ON Semiconductor makes no warranty, representation or guarantee regarding the suitability of its products for any particular purpose, nor does ON Semiconductor assume any liability arising out of the application or use of any product or circuit, and specifically disclaims any and all liability, including without limitation special, consequential or incidental damages. ON Semiconductor does not convey any license under its patent rights nor the rights of others.

onsemi, **Onsemi**, and other names, marks, and brands are registered and/or common law trademarks of Semiconductor Components Industries, LLC dba "**onsemi**" or its affiliates and/or subsidiaries in the United States and/or other countries. **onsemi** owns the rights to a number of patents, trademarks, copyrights, trade secrets, and other intellectual property. A listing of **onsemi**'s product/patent coverage may be accessed at www.onsemi.com/site/pdf/Patent-Marking.pdf. **onsemi** reserves the right to make changes at any time to any products or information herein, without notice. The information herein is provided "as-is" and **onsemi** makes no warranty, representation or guarantee regarding the accuracy of the information, product features, availability, functionality, or suitability of its products for any particular purpose, nor does **onsemi** assume any liability arising out of the application or use of any product or circuit, and specifically disclaims any and all liability, including without limitation special, consequential or incidental damages. Buyer is responsible for its products and applications using **onsemi** products, including compliance with all laws, regulations and safety requirements or standards, regardless of any support or applications information provided by **onsemi**. "Typical" parameters which may be provided in **onsemi** data sheets and/or specifications can and do vary in different applications and actual performance may vary over time. All operating parameters, including "Typicals" must be validated for each customer application by customer's technical experts. **onsemi** does not convey any license under any of its intellectual property rights nor the rights of others. **onsemi** products are not designed, intended, or authorized for use as a critical component in life support systems or any FDA Class 3 medical devices or medical devices with a same or similar classification in a foreign jurisdiction or any devices intended for implantation in the human body. Should Buyer purchase or use **onsemi** products for any such unintended or unauthorized application, Buyer shall indemnify and hold **onsemi** and its officers, employees, subsidiaries, affiliates, and distributors harmless against all claims, costs, damages, and expenses, and reasonable attorney fees arising out of, directly or indirectly, any claim of personal injury or death associated with such unintended or unauthorized use, even if such claim alleges that **onsemi** was negligent regarding the design or manufacture of the part. **onsemi** is an Equal Opportunity/Affirmative Action Employer. This literature is subject to all applicable copyright laws and is not for resale in any manner.

ADDITIONAL INFORMATION

TECHNICAL PUBLICATIONS:

Technical Library: www.onsemi.com/design/resources/technical-documentation
onsemi Website: www.onsemi.com

ONLINE SUPPORT: www.onsemi.com/support

For additional information, please contact your local Sales Representative at www.onsemi.com/support/sales