

### TO-92S



#### Pin Definition:

1. V<sub>CC</sub>
2. GND
3. Output

### Description

TSH481 is a linear Hall-effect sensor which is composed of Hall sensor, linear amplifier and Totem-Pole output stage. It features low noise output, which makes it unnecessary to use external filtering. It also can provide increased temperature stability and accuracy. The linear Hall sensor has a wide operating temperature range of -40 °C to +105 °C, appropriate for commercial, consumer, and industrial environments.

The high sensitivity of Hall-effect sensor accurately tracks extremely weak changes in magnetic flux density. The linear sourcing output voltage is set by the supply voltage and in proportion of variation of the magnetic flux density. Typical operation current is 2.5mA and operating voltage range is 3.0V to 6.5V

### Features

- Operating Voltage Range: 3.0V~6.5V
- Low-Noise Operation
- Linear output for circuit design flexibility
- Totem-Pole for a stable and accurate output
- Responds to either positive or negative magnetic flux density
- Robust ESD performance

### Ordering Information

Part No.	Package	Packing
TSH481CT B0G	TO-92S	1kpcs / Bulk Bag

**Note:** "G" denote for Halogen Free Product

### Application

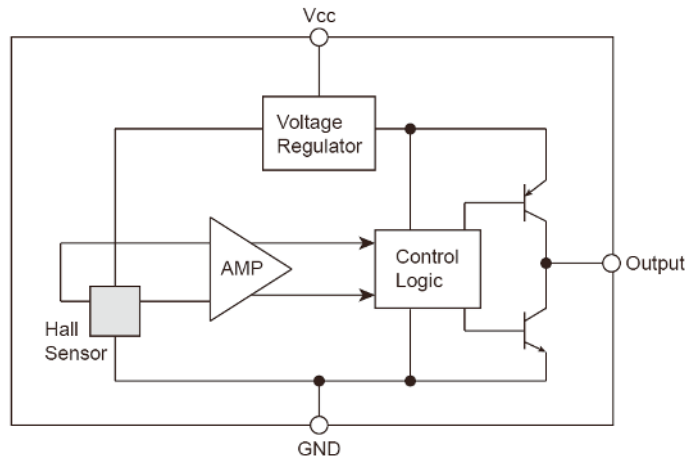
- Current sensing
- Motor control
- Position sensing
- Magnetic code reading
- Rotary encoder
- Ferrous metal detector
- Vibration sensing
- Liquid level sensing
- Weight sensing

### Absolute Maximum Ratings (T<sub>A</sub> = 25°C unless otherwise noted)

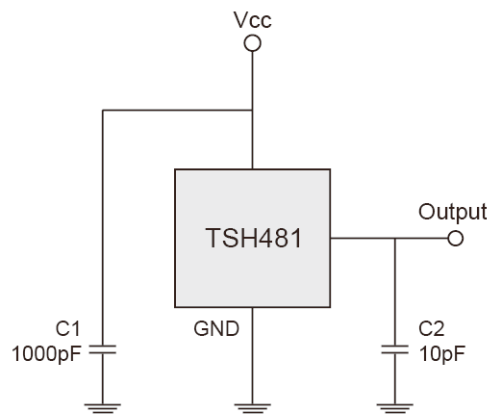
Characteristics	Limit	Value	Unit
Supply voltage	V <sub>CC</sub>	8	V
Reverse voltage	V <sub>CC</sub>	-0.5	V
Magnetic flux density		Unlimited	G
Output current	I <sub>OUT</sub>	10	mA
Operating Temperature Range	T <sub>OPR</sub>	-40 to +85	°C
Storage temperature range	T <sub>STG</sub>	-65 to +150	°C
Maximum Junction Temp	T <sub>J</sub>	150	°C
Thermal Resistance - Junction to Ambient	R <sub>θJA</sub>	206	°C/W
Thermal Resistance - Junction to Case	R <sub>θJC</sub>	148	°C/W
Package Power Dissipation	P <sub>D</sub>	606	mW

**Note:** Exceeding the absolute maximum ratings may cause permanent damage. Exposure to absolute maximum-rated conditions for extended periods may affect device reliability.

### Block Diagram



### Typical Application Circuit



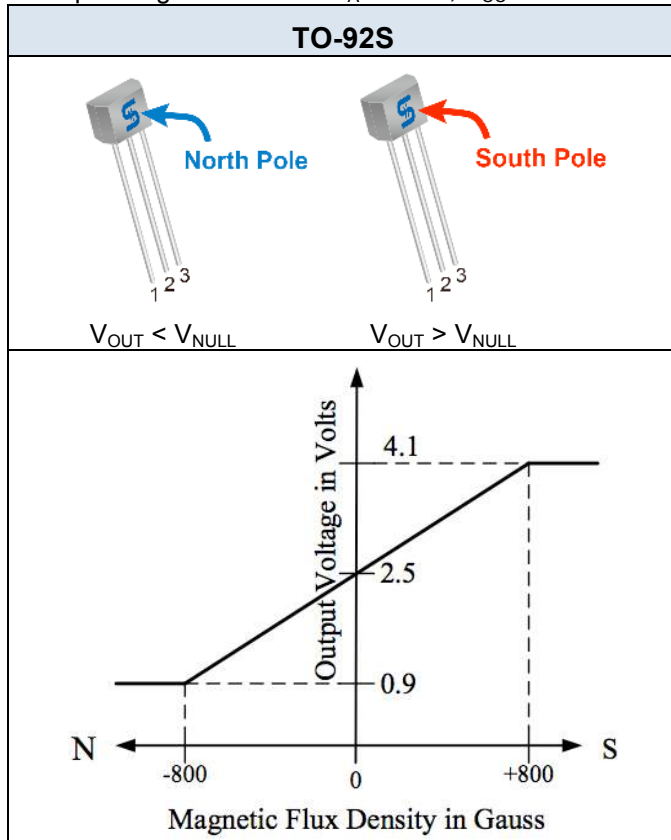
### Electrical Specifications (DC Operating Parameters: $T_A=+25^{\circ}\text{C}$ , $V_{CC}=5\text{V}$ )

Parameters	Test Conditions	Min	Typ	Max	Units
Supply Voltage	Operating	3.0	--	6.5	V
Supply Current	B=0 G	--	2.5	5.0	mA
Output Current	$V_{CC}>3\text{V}$	1.0	1.5	--	mA
Null Output Voltage	B=0 G	2.3	2.5	2.7	V
Output Bandwidth		--	20	--	kHz
Output Voltage Span		2.95	3.2	--	V
Magnetic Range Gauss		$\pm 500$	$\pm 800$	--	G
Linearity	% of Span	--	0.7	--	
Response Time		--	3	--	$\mu\text{s}$
Sensitivity		1.8	--	2.2	mV/G
Electro-Static Discharge	HBM	3	--	--	kV

**Note:** 1G (Gauss) = 0.1mT (millitesla)

### Output Behavior versus Magnetic Pole

DC Operating Parameters:  $T_A=+25^{\circ}\text{C}$ ,  $V_{CC}=5\text{V}$



## Characteristic Performance

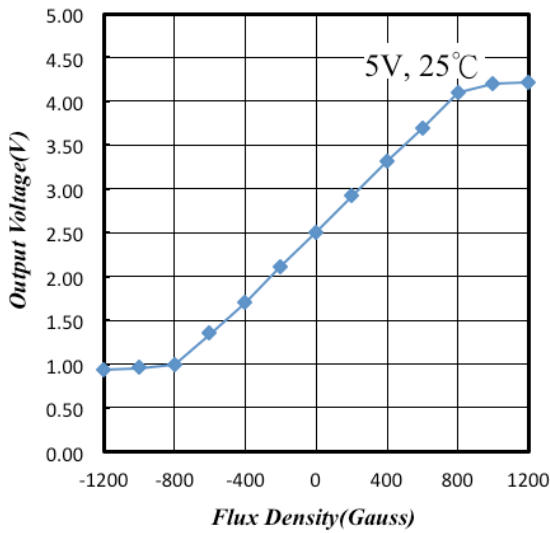


Figure 1. Output Voltage vs. Flux Density

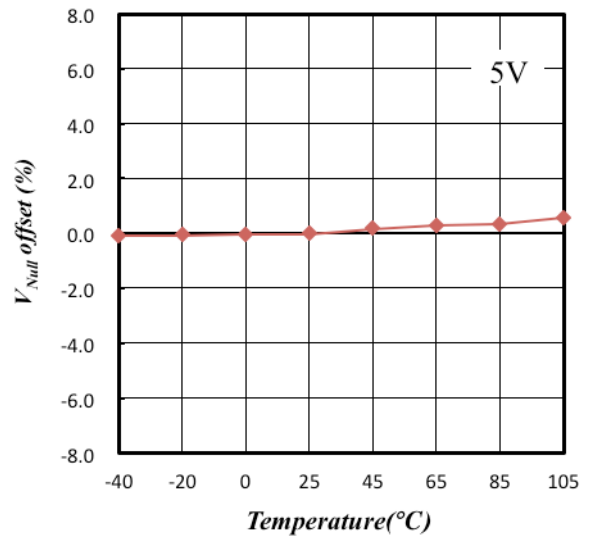


Figure 2. Output Voltage Offset vs. Temperature

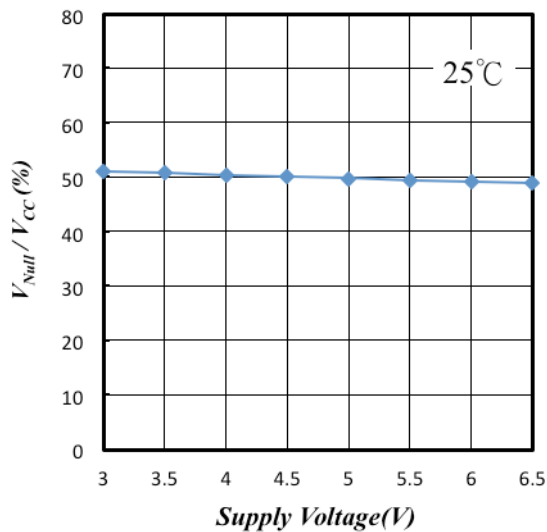


Figure 3. Vout/Vcc Ratio vs. Supply Current

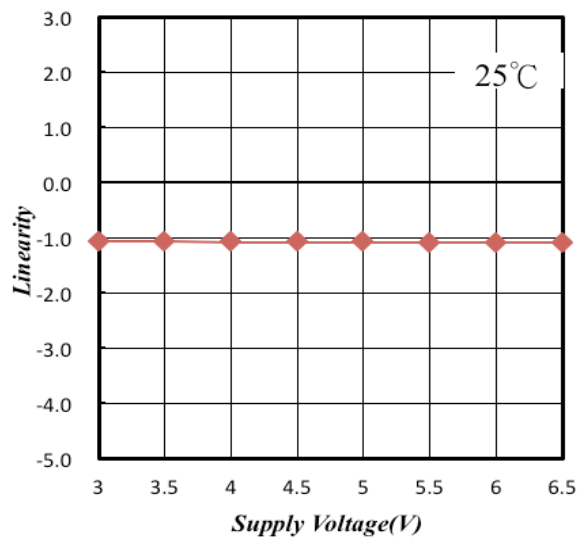


Figure 4. Linearity vs. Supply Voltage

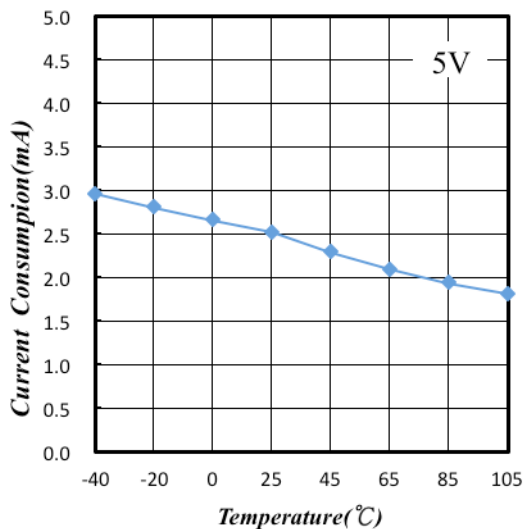


Figure 5. Supply Current vs. Temperature

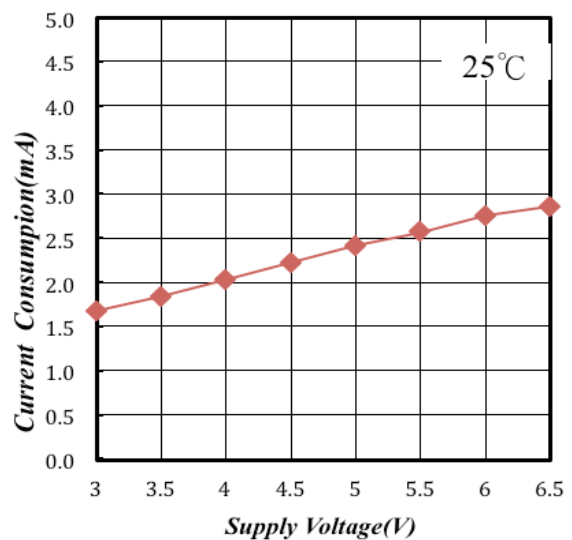
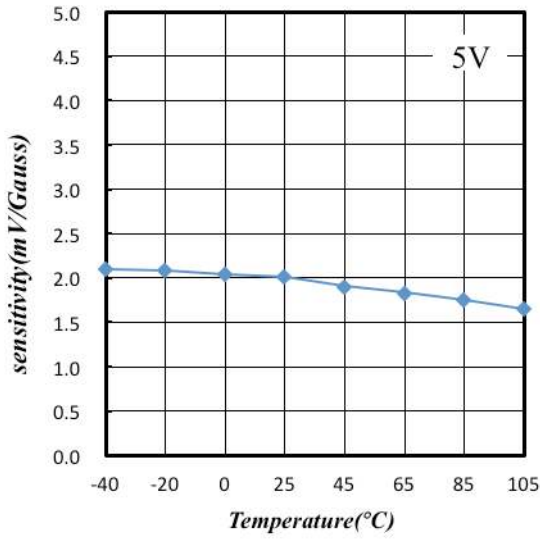
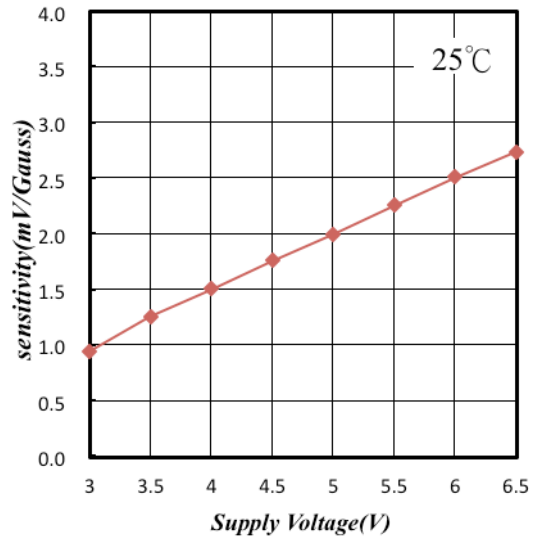


Figure 6. Supply Current vs. Supply Voltage

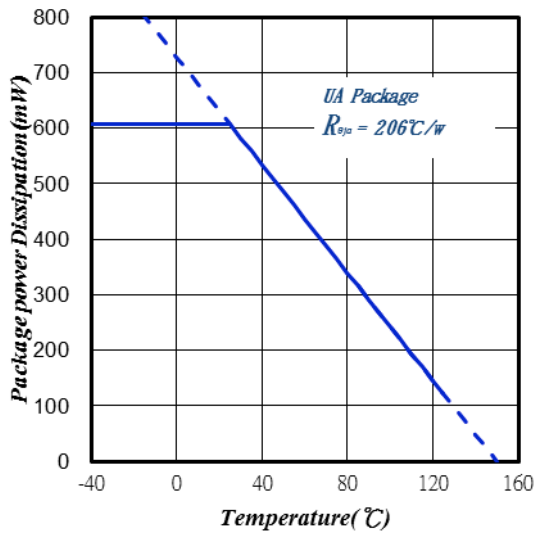
**Characteristic Performance**



**Figure 7. Sensitivity vs. Temperature**

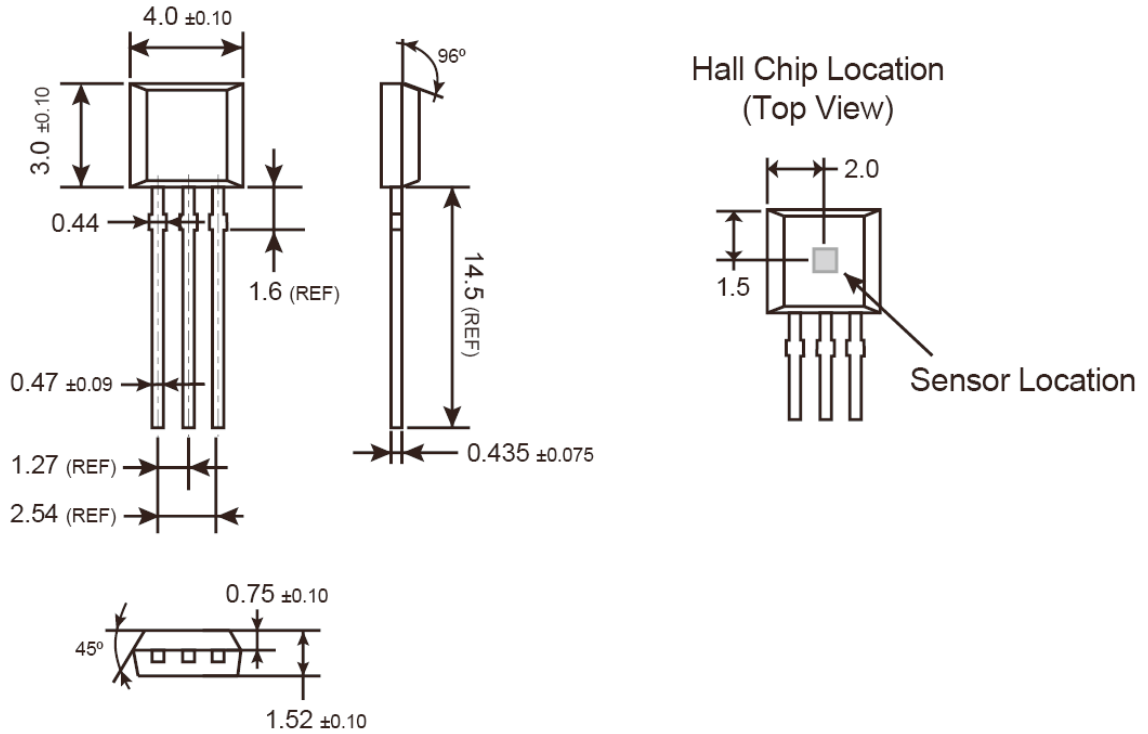


**Figure 8. Sensitivity vs. Supply Voltage**



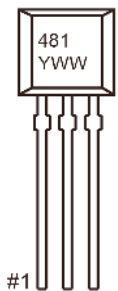
**Figure 8. Power Dissipation vs. Temperature**

**TO-92S Mechanical Drawing**



Unit: Millimeters

**Marking Diagram**



- 481** = Device Code
- Y** = Year Code (3=2013, 4=2014....)
- WW** = Week Code (01~52)

### Notice

Specifications of the products displayed herein are subject to change without notice. TSC or anyone on its behalf, assumes no responsibility or liability for any errors or inaccuracies.

Information contained herein is intended to provide a product description only. No license, express or implied, to any intellectual property rights is granted by this document. Except as provided in TSC's terms and conditions of sale for such products, TSC assumes no liability whatsoever, and disclaims any express or implied warranty, relating to sale and/or use of TSC products including liability or warranties relating to fitness for a particular purpose, merchantability, or infringement of any patent, copyright, or other intellectual property right.

The products shown herein are not designed for use in medical, life-saving, or life-sustaining applications. Customers using or selling these products for use in such applications do so at their own risk and agree to fully indemnify TSC for any damages resulting from such improper use or sale.