

NOTES:

1. SEALED TO IP67 RATING
2. ROHS COMPLIANT
3. VERTICAL LIGHT PIPE PRE-ASSEMBLED WITH INSERT AND HOUSING. ANGLED LIGHT PIPE SHIPPED NON-ASSEMBLED
4. MOUNTING HARDWARE SHIPPED NON-ASSEMBLED

REVISIONS			
REV.	DESCRIPTION	DATE	APPROVED
A	ENGINEERING RELEASE	1/18/2021	A.V.
B	Updated Component Tables	2/16/2021	A.V.
C	Updated Descriptions	3/17/2021	A.V.

ANGLED LIGHT PIPE PART NUMBER CONFIGURATION

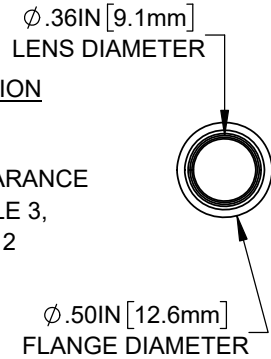
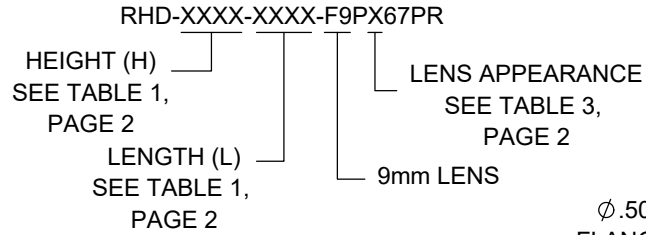

ANGLED LIGHT PIPE CONFIGURATION

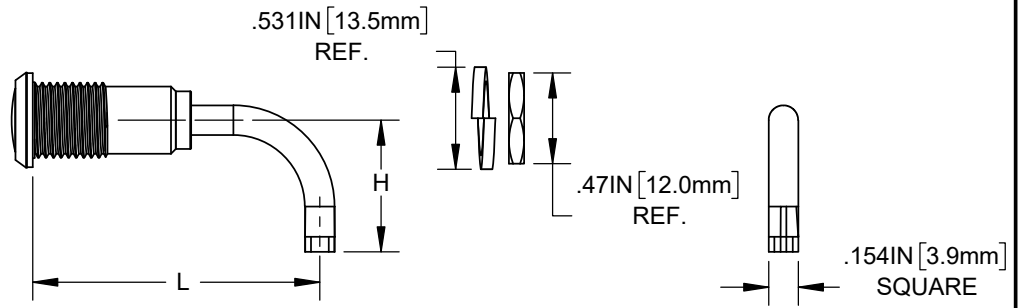

VERTICAL LIGHT PIPE PART NUMBER CONFIGURATION

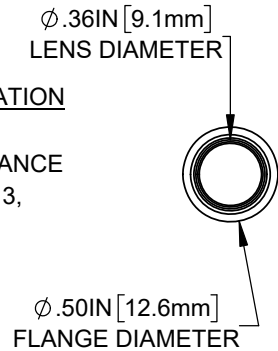
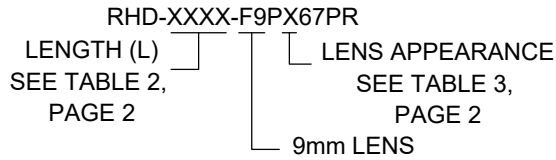

VERTICAL LIGHT PIPE CONFIGURATION

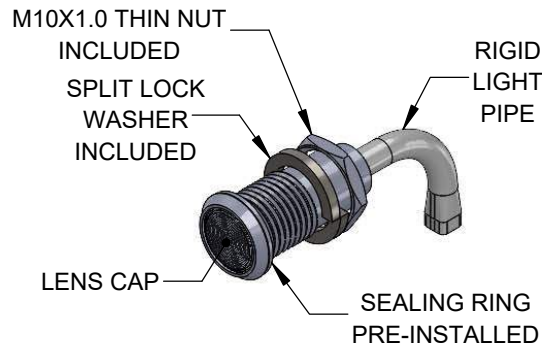
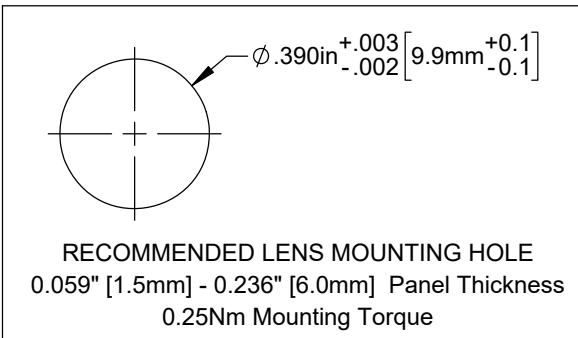
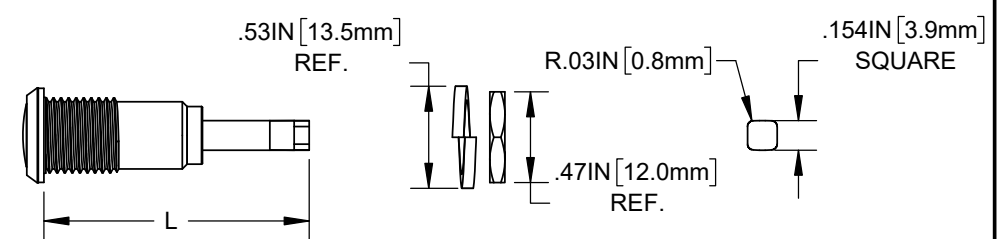

CUSTOMER USE DRAWING

STANDARD TOLERANCE (UNLESS OTHERWISE SPECIFIED)		 4 THOMAS, IRVINE, CA. 92618 TEL: (949) 951-8808 FAX: (949) 951-3974	
DECIMALS	ANGULAR		
.X ± .1	X° ± 1°	TITLE: IP67 Rigid Heavy Duty Light Pipe	
.XX ± .02			
.XXX ± .010		DRAWING NO: RHD-XXXX-XXXX-F9PX67PR REVISION: C	SHEET SIZE: A CAGE CODE: 32559
DESIGNED: K. BARON	DATE: 01/18/2021	SCALE: 2:1 SHEET # 1 OF 2	
REVISD: K. BARON	DATE: 03/17/2021	CAD GENERATED DOCUMENT, DO NOT MEASURE DRAWING	
CHECKED: A. VALDEZ	DATE: 03/17/2021		

TABLE 1 - ANGLED LIGHT PIPE		
ORDER CODE	HEIGHT (H)	LENGTH (L)
0700-1500	.686 [17.4mm]	1.496 [38.0mm]
0700-2000		1.996 [50.7mm]
0700-2500		2.496 [63.4mm]
0700-3000		2.996 [76.1mm]
0700-3500		3.496 [88.8mm]
0900-1500	.886" [22.5mm]	1.496 [38.0mm]
0900-2000		1.996 [50.7mm]
0900-2500		2.496 [63.4mm]
0900-3000		2.996 [76.1mm]
0900-3500		3.496 [88.8mm]
1100-1500	1.136 [28.9mm]	1.496 [38.0mm]
1100-2000		1.996 [50.7mm]
1100-2500		2.496 [63.4mm]
1100-3000		2.996 [76.1mm]
1100-3500		3.496 [88.8mm]

TABLE 2 - VERTICAL LIGHT PIPE	
ORDER CODE	LENGTH (L)
1140	1.132 [28.8mm]
1390	1.382 [30.1mm]
1640	1.632 [41.5mm]
1890	1.882 [47.8mm]
2140	2.132 [54.2mm]
2390	2.382 [60.5mm]

TABLE 3 - LENS APPEARANCE	
ORDER CODE	LENS APPEARANCE
Z	FRESNEL CLEAR
ZB	FRESNEL BLUE
ZG	FRESNEL GREEN
ZR	FRESNEL RED
ZY	FRESNEL YELLOW
(BLANK)	CLEAR
D	DIFFUSED
S	SMOKED

SAMPLE PART NUMBER - ANGLED LIGHT PIPE

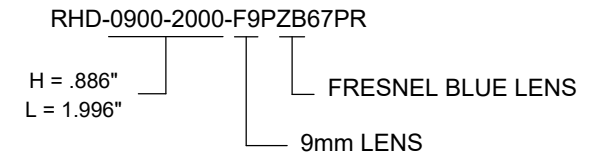

SAMPLE PART NUMBER - VERTICAL LIGHT PIPE

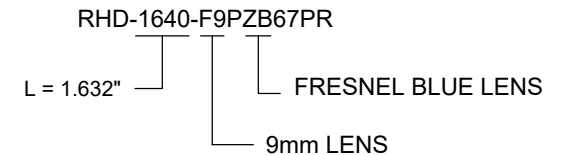

CUSTOMER USE DRAWING

		BIVAR [®]	
CAGE CODE:	32559	DRAWING NO: RHD-XXXX-XXXX-F9PX67PR	REVISION: C
SHEET SIZE:	A	SCALE: 2:1	SHEET # 2 OF 2
<small>CAD GENERATED DOCUMENT, DO NOT MEASURE DRAWING</small>			