

**NOTES:**

1. Material : Music Wire
2. Finish : Glod Irridite
3. Ends : Closed
4. Total Coils : 10.000
5. Sugg. Max. Deflection : 0.090 (in)
6. Sugg. Max. Load : 2.300 (lbs)
7. All Drawing Dimensions are in Inches [mm]

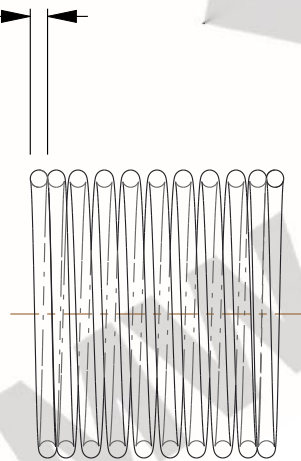

∅ 0.030  
[0,76]  
WIRE DIA



1.910  
[48,51]  
LENGTH

∅ 0.500  
[12,70]  
O.D

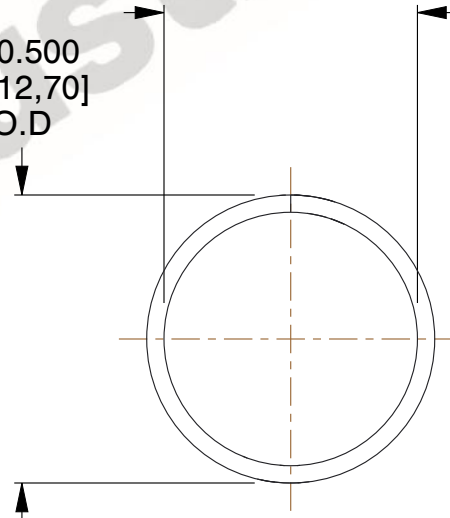

∅ 0.440  
[11,18]  
I.D

COMPONENT		SPRINGS	
<p><b>11772</b></p> <p>COMPRESSION SPRINGS</p>		UNIT	INCH [mm]
		SHEET	1 of 1