

Mechanical Dimensions: Inches [mm]

Tolerances ± 0.012 [0.5] Unless Otherwise Specified

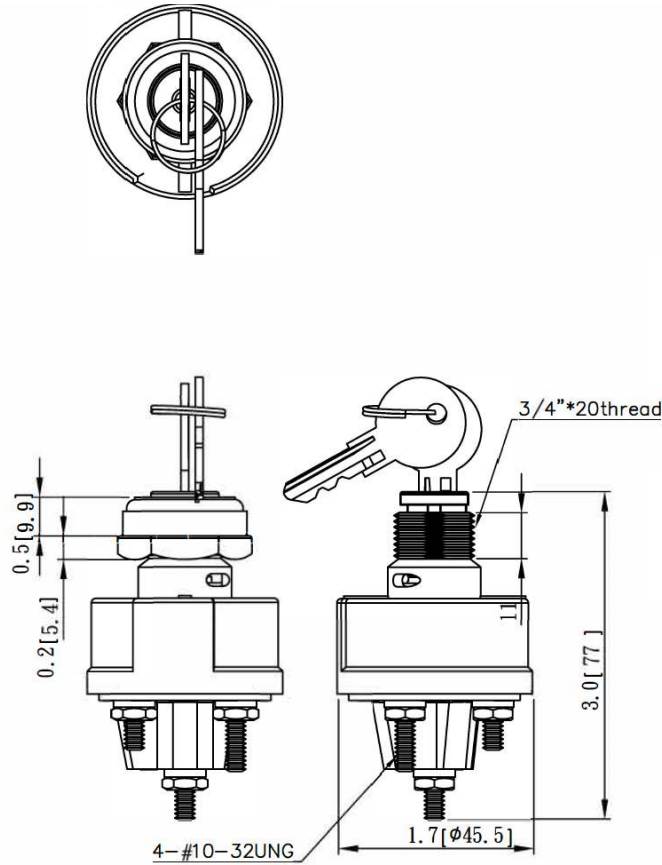

Mounting Hole

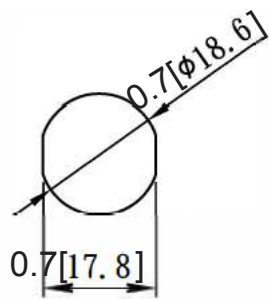

Circuit Diagram

4 Positions

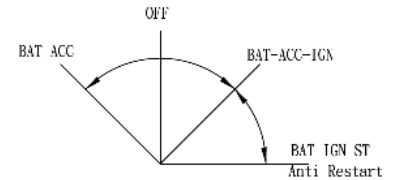

Electrical Specifications

Continuous Rating	30A 12VDC
IGN Terminal Rating	8A 14VDC
ACC Terminal	30A 14VDC
Start	75A Make, 20A Break 14VDC

Material Specifications

Zinc diecast construction
Copper terminals
2 Brass keys

Rev	Date of issue	Revision Notes	Designed	Approved
A	11-12-2019	Initial Drawing	RC	OF