

DS2422

1-Wire Temperature/Datalogger with 8KB Datalog Memory

GENERAL DESCRIPTION

The DS2422 temperature/datalogger combines the core functions of a fully featured datalogger in a single chip. It includes a temperature sensor, real-time clock (RTC), memory, 1-Wire® interface, and serial interface for an analog-to-digital converter (ADC) as well as control circuitry for a charge pump. The ADC and the charge pump are peripherals that can be added to build application-specific dataloggers. Without external ADC, the DS2422 functions as a temperature logger only. The DS2422 measures the temperature and/or reads the ADC at a user-defined rate. A total of 8192 8-bit readings or 4096 16-bit readings taken at equidistant intervals ranging from 1s 273hrs can be stored.

APPLICATIONS

Temperature Logging in Cold Chain, Food Safety, and Bio Science

High-Temperature Logging (Process Monitoring, industrial Temperature Monitoring)

General-Voltage Datalogging (Pressure, Humidity, Light, Material Stress)

PIN CONFIGURATION

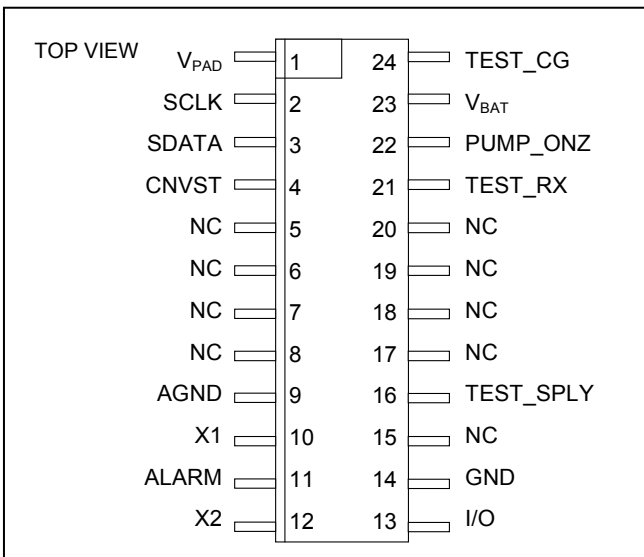

1-Wire is a registered trademark of Maxim Integrated Products, Inc.

FEATURES

- Automatically Wakes Up, Measures Temperature and/or Reads an External ADC and Stores Values in 8KB of Datalog Memory in 8 or 16-Bit Format
- On-Chip Direct-to-Digital Temperature Converter with 8-Bit (0.5°C) or 11-Bit (0.0625°C) Resolution
- Sampling Rate from 1s up to 273hrs
- Programmable Recording Start Delay After Elapsed Time or Upon a Temperature Alarm Trip Point
- Programmable High and Low Trip Points for Temperature and Data Alarms
- Quick Access to Alarmed Devices Through 1-Wire Conditional Search Function
- 512 Bytes of General-Purpose Memory Plus 64 Bytes of Calibration Memory
- Two-Level Password Protection of all Memory and Configuration Registers
- Unique Factory-Lasered 64-Bit Registration Number Assures Error-Free Device Selection and Absolute Part Identity
- Built-in Multidrop Controller Ensures Compatibility with Other Maxim 1-Wire Net Products
- Directly Connects to a Single Port Pin of a Microprocessor and Communicates at Up to 15.4kbps at Standard Speed or up to 125kbps in Overdrive Mode
- 40°C to +85°C Operating Range
- 2.8V to 3.6V Single-Supply Battery Operation
- Low Power (1.2µA Standby, 350µA Active)

ORDERING INFORMATION

PART	TEMP RANGE	PIN-PACKAGE
DS2422S+	-40°C to +85°C	24-lead, 300-mil SO

+Denotes a lead(Pb)-free/RoHS-compliant product.

Commands, Registers, and Modes are capitalized for clarity.

Note: Some revisions of this device may incorporate deviations from published specifications known as errata. Multiple revisions of any device may be simultaneously available through various sales channels. For information about device errata, click here: www.maxim-ic.com/errata.

For pricing, delivery, and ordering information, please contact Maxim Direct at 1-888-629-4642, or visit Maxim's website at www.maximintegrated.com.

ABSOLUTE MAXIMUM RATINGS*

ALARM, PUMP_ONZ, SDATA, SCLK, CNVST, VPAD, I/O Voltage to GND	-0.3V, +6V
ALARM, PUMP_ONZ, I/O Combined Sink Current	20mA
Operating Temperature Range	-40°C to +85°C
Junction Temperature	+150°C
Storage Temperature Range	-55°C to +125°C
Lead Temperature (soldering, 10s)	300°C
Soldering Temperature (reflow)	260°C

Stresses beyond those listed under "Absolute Maximum Ratings" may cause permanent damage to the device. These are stress ratings only, and functional operation of the device at these or any other conditions beyond those indicated in the operational sections of the specifications is not implied. Exposure to the absolute maximum rating conditions for extended periods may affect device.

ELECTRICAL CHARACTERISTICS

($V_{PUP} = 3.0V$ to $5.25V$, $V_{BAT} = 2.0V$ to $3.6V$, $V_{PAD} = 3.0V$ to $5.5V$, $T_A = -40^\circ C$ to $+85^\circ C$.) (Note 20)

PARAMETER	SYMBOL	CONDITIONS	MIN	TYP	MAX	UNITS
Standby Supply Current	I_{BAT1}	V_{BAT} at 3.0V, I/O at 0V, RTC on		1200	2000	nA
	I_{BAT0}	V_{BAT} at 3.6V, I/O at 0V, RTC off		50	650	
Ground Current	I_{GND}	Applies individually to GND, AGND (Note 1)			20	mA
I/O Pin General Data						
1-Wire Pullup Resistance	R_{PUP}	(Notes 1, 2)			2.2	k Ω
Input Capacitance	C_{IO}	(Notes 3, 4)		100	800	pF
Input Load Current	I_L	I/O pin at V_{PUP} , $V_{BAT} = 3.6V$		6	10	μA
High-to-Low Switching Threshold	V_{TL}	(Notes 4, 5, 6)	0.4		3.2	V
Input Low Voltage	V_{IL}	(Notes 1, 7)			0.3	V
Low-to-High Switching Threshold	V_{TH}	(Notes 4, 5, 8)	0.7		3.4	V
Switching Hysteresis	V_{HY}	(Notes 4, 9)	0.09		N/A	V
Output Low Voltage	V_{OL}	At 4mA (Note 10)			0.4	V
Recovery Time (Note 1)	t_{REC}	Standard speed, $R_{PUP} = 2.2k\Omega$	5			μs
		Overdrive speed, $R_{PUP} = 2.2k\Omega$	2			
		Overdrive speed, directly prior to reset pulse; $R_{PUP} = 2.2k\Omega$	5			
Rising-Edge Hold-off Time	t_{REH}	(Notes 4, 11)	0.6		2.0	μs
Timeslot Duration (Note 1)	t_{SLOT}	Standard speed	65			μs
		Overdrive speed, $V_{PUP} > 4.5V$	8			
		Overdrive speed (Note 12)	9.5			
I/O Pin, 1-Wire Reset, Presence Detect Cycle						
Reset Low Time (Note 1)	t_{RSTL}	Standard speed, $V_{PUP} > 4.5V$	480		720	μs
		Standard speed (Note 12)	690		720	
		Overdrive speed, $V_{PUP} > 4.5V$	48		80	
		Overdrive speed (Note 12)	70		80	
Presence Detect High Time	t_{PDH}	Standard speed, $V_{PUP} > 4.5V$	15		60	μs
		Standard speed (Note 12)	15		63.5	
		Overdrive speed (Note 12)	2		7	
Presence Detect Fall Time (Notes 4, 13)	t_{FPD}	Standard speed, $V_{PUP} > 4.5V$	1.5		5	μs
		Standard speed	1.5		8	
		Overdrive speed	0.15		1	
Presence Detect Low Time	t_{PDL}	Standard speed, $V_{PUP} > 4.5V$	60		240	μs
		Standard speed (Note 12)	60		287	
		Overdrive speed, $V_{PUP} > 4.5V$ (Note 12)	7		24	
		Overdrive speed (Note 12)	7		28	
Presence Detect Sample Time (Note 1)	t_{MSP}	Standard speed, $V_{PUP} > 4.5V$	65		75	μs
		Standard speed	71.5		75	
		Overdrive speed	8		9	

PARAMETER	SYMBOL	CONDITIONS	MIN	TYP	MAX	UNITS
I/O Pin, 1-Wire Write						
Write-0 Low Time (Notes 1, 14)	t_{W0L}	Standard speed	60		120	μs
		Overdrive speed, $V_{PUP} > 4.5\text{V}$ (Note 12)	6		12	
		Overdrive speed (Note 12)	7.5		12	
Write-1 Low Time (Notes 1, 14)	t_{W1L}	Standard speed	5		15	μs
		Overdrive speed	1		1.95	
I/O Pin, 1-Wire Read						
Read Low Time (Notes 1, 15)	t_{RL}	Standard speed	5		$15 - \delta$	μs
		Overdrive speed	1		$1.95 - \delta$	
Read Sample Time (Notes 1, 15)	t_{MSR}	Standard speed	$t_{RL} + \delta$		15	μs
		Overdrive speed	$t_{RL} + \delta$		1.95	
ALARM Output Pin						
Output Low Voltage	V_{OL}	Sink current 4mA			0.7	V
Pin Leakage Current	I_{LP}	ALARM pin at 6V			6	μA
CNVST, SCLK Output Pins						
Output Low Voltage	V_{OL}	$V_{PAD} = 5\text{V}, I_L = 3\text{mA}$			0.3	V
		$V_{PAD} = 3\text{V}, I_L = 3\text{mA}$			0.3	
Output High Voltage	V_{OH}	$V_{PAD} = 5\text{V}, I_L = 3\text{mA}$	4			V
		$V_{PAD} = 3\text{V}, I_L = 3\text{mA}$	2			
PUMP_ONZ Output Pin						
Output Low Voltage	V_{OL}	$V_{BAT} = 3.6\text{V}, I_L = 2\text{mA}$			0.4	V
		$V_{BAT} = 2.0\text{V}, I_L = 2\text{mA}$			0.4	
Output High Voltage	V_{OH}	$V_{BAT} = 3.6\text{V}, I_L = 0.5\text{mA}$	2.5			V
		$V_{BAT} = 2.0\text{V}, I_L = 0.5\text{mA}$	1.4			
SDATA Input Pin						
Input High Voltage	V_{IH}	$V_{BAT} = 3.6\text{V}$	2.5			V
		$V_{BAT} = 2.0\text{V}$	1.4			
Input Low Voltage	V_{IL}	$V_{BAT} = 3.6\text{V}$			0.4	V
		$V_{BAT} = 2.0\text{V}$			0.4	
Pin Leakage Current	I_{LP}	SDATA pin at 5.5V			10	μA
Serial Interface Timing						
CLK Period	t_{RING}		0.5	1	9	μs
PUMP_ONZ Fall to CNVST Rise	t_{SP}	Power-on default (Notes 4, 19)	3.5	4	4.5	ms
CNVST Pulse Width	t_{CPW}	(Note 4)	70	140	1260	μs
CNVST Fall to SCLK High (First Clock)	t_{SCH}	(Note 4)	8	16	144	μs
SCLK Period	t_{SCP}	50% duty cycle (Note 4)	1	2	18	μs
SDATA Setup Time	t_{SDS}	(Note 4)	75			ns
SDATA Hold Time	t_{SDH}	(Note 4)	3			ns
Real-Time Clock						
Accuracy		+25°C (Note 16)	-2		+2	min./ month
Frequency Deviation	Δ_F	-40°C to +85°C (Note 16)	-300		+60	PPM
Temperature Converter						
Operating Range	T_{TC}	3V at V_{BAT}	-40		+85	°C
Conversion Time (Note 4)	t_{CONV}	8-bit mode	30	50	75	ms
		16-bit mode (11 bits)	240	400	600	
Thermal Response Time Constant (Notes 4, 17)	τ_{RESP}	SO package		95		s
Conversion Error (Notes 4, 18)	$\Delta\theta$	+10°C to +60°C	See <i>Temperature Accuracy</i> Graphs			°C
		-40°C to +85°C				
Conversion Current	I_{CONV}	(Note 4)	180	350	550	μA

- Note 1:** System Requirement
- Note 2:** Maximum allowable pullup resistance is a function of the number of 1-Wire devices in the system and 1-Wire recovery times. The specified value here applies to systems with only one device and with the minimum 1-Wire recovery times. For more heavily loaded systems, an active pullup such as that found in the DS2480B may be required.
- Note 3:** Capacitance on the data pin could be 800pF when V_{PUP} is first applied. If a 2.2k Ω resistor is used to pull up the data line, 2.5 μ s after V_{PUP} has been applied the parasite capacitance will not affect normal communications.
- Note 4:** Guaranteed by design, not production tested.
- Note 5:** V_{TL} and V_{TH} are functions of the internal supply voltage, which is a function of V_{PUP} and the 1-Wire recovery times. The V_{TH} and V_{TL} maximum specifications are valid at $V_{PUP} = 5.25V$. In any case, $V_{TL} < V_{TH} < V_{PUP}$.
- Note 6:** Voltage below which, during a falling edge on I/O, a logic '0' is detected.
- Note 7:** The voltage on I/O needs to be less or equal to V_{ILMAX} whenever the master drives the line low.
- Note 8:** Voltage above which, during a rising edge on I/O, a logic '1' is detected.
- Note 9:** After V_{TH} is crossed during a rising edge on I/O, the voltage on I/O has to drop by V_{HY} to be detected as logic '0'.
- Note 10:** The I-V characteristic is linear for voltages less than 1V.
- Note 11:** The earliest recognition of a negative edge is possible at t_{REH} after V_{TH} has been previously reached.
- Note 12:** Highlighted numbers are NOT in compliance with the published iButton standards. See comparison table below.
- Note 13:** Interval during the negative edge on I/O at the beginning of a Presence Detect pulse between the time at which the voltage is 90% of V_{PUP} and the time at which the voltage is 10% of V_{PUP} .
- Note 14:** ϵ in Figure 16 represents the time required for the pullup circuitry to pull the voltage on I/O up from V_{IL} to V_{TH} . The actual maximum duration for the master to pull the line low is $t_{W1LMAX} + t_F - \epsilon$ and $t_{W0LMAX} + t_F - \epsilon$ respectively.
- Note 15:** δ in Figure 16 represents the time required for the pullup circuitry to pull the voltage on I/O up from V_{IL} to the input high threshold of the bus master. The actual maximum duration for the master to pull the line low is $t_{RLMAX} + t_F$.
- Note 16:** This is the expected range when using a crystal equivalent to the Seiko SPT2AF-12.5PF20PPM ..
- Note 17:** Time to reach 63% of the temperature change; measured at a temperature transition step from +25°C to +85°C.
- Note 18:** A 2-point calibration trim at 3V must be done to achieve the specified accuracy at 3V. See Application Note 2810, [DS2422 Trim Procedure and Software Correction](#), for details.
- Note 19:** The duration is user-programmable from 0ms (code 00h) to 127.5ms (code FFh) with a tolerance of ± 0.5 ms. See *Delay Register*, address 400h, for details.
- Note 20:** Guaranteed by design, not production tested to -40°C.

PARAMETER NAME	STANDARD VALUES				DS2422 VALUES			
	STANDARD SPEED		OVERDRIVE SPEED		STANDARD SPEED		OVERDRIVE SPEED	
	MIN	MAX	MIN	MAX	MIN	MAX	MIN	MAX
t_{SLOT} (incl. t_{REC})	61 μ s	(undef.)	7 μ s	(undef.)	65 μ s ¹⁾	(undef.)	9.5 μ s	(undef.)
t_{RSTL}	480 μ s	(undef.)	48 μ s	80 μ s	690 μ s	720 μ s	70 μ s	80 μ s
t_{PDH}	15 μ s	60 μ s	2 μ s	6 μ s	15 μ s	63.5 μ s	2 μ s	7 μ s
t_{PDL}	60 μ s	240 μ s	8 μ s	24 μ s	60 μ s	287 μ s	7 μ s	28 μ s
t_{W0L}	60 μ s	120 μ s	6 μ s	16 μ s	60 μ s	120 μ s	7.5 μ s	12 μ s

¹⁾ Intentional change, longer recovery time requirement due to modified 1-Wire front end.

DS2422 Temperature Accuracy at 3V

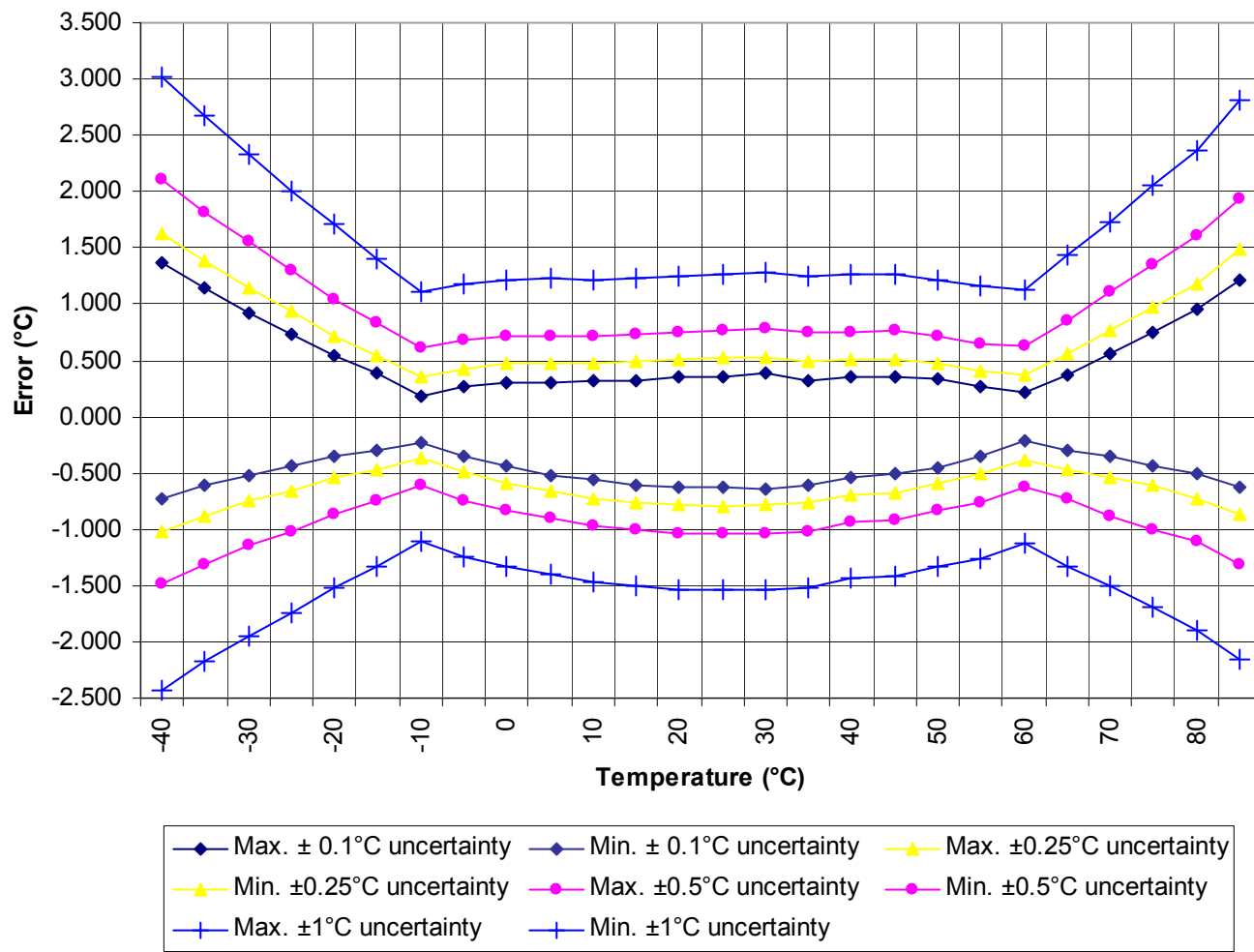

"Uncertainty" refers to the uncertainty of the temperature measurement when performing the 2-point calibration trim as described in Application Note 2810. These graphs assume 11-bit temperature conversion. The accuracy can be improved further through software correction, as described in Application Note 2810.

PIN DESCRIPTION

PIN	NAME	FUNCTION
1	V _{PAD}	Operating voltage of the serial interface pads CNVST, SCLK, SDATA. Used for level translation from the V _{BAT} -powered internal logic to the 5V-powered ADC. Connect to V _{BAT} if the serial interface is not used.
2	SCLK	Serial clock signal for serial interface. May connect directly to the corresponding MAX1086 pin. The idle state for the pin is low.
3	SDATA	Serial data pin for the serial interface. May connect directly to the DOUT pin of MAX1086. The pin includes a weak pulldown and therefore has an idle state of low.
4	CNVST	Conversion Start control signal for the MAX1086. The idle state for the pin is low.
9	AGND	Analog ground. Ground reference for external ADC and charge pump.
10	X1	First of two crystal pins for the real time clock crystal. A standard 6pF 32KHz crystal is used. The accuracy of the device's real time clock is largely dependent on the temperature characteristics of the crystal. Trace length from the device to the crystal should be minimized to reduce their capacitive effect.
11	ALARM	Logic open-drain output with 215Ω maximum on-resistance, operating range 0V to 5.25V. Power-on default is OFF.
12	X2	Second of two crystal pins for the real time clock crystal.
13	IO	1-Wire communication line, data input and output. This pin also charges the internal parasitic power cap that allows the 1-Wire front end of the device to run without V _{BAT} supply.
14	GND	Common ground supply for the device and V _{BAT} .
16	TEST_SPLY	Connect to GND (test pin)
21	TEST_RX	Connect to GND (test pin)
22	PUMP_ONZ	Signal to control an external charge-pump. The signal polarity is designed to fit to the MAX619 charge pump/regulator.
23	V _{BAT}	3V power supply for the device, typically a battery. This pin supplies power to all parts of the device except for the 1-Wire front end.
24	TEST_CG	Do not connect (test pin)
9 pins	NC	Not connected

DESCRIPTION

The DS2422 temperature/data logger combines the core functions of a fully featured data logger in a single chip. It includes a temperature sensor, RTC, memory, 1-Wire interface, and serial interface for an analog-to-digital converter (ADC) as well as control circuitry for a charge pump. The ADC and the charge pump are peripherals that can be added to build application-specific data loggers. Without external ADC, the DS2422 functions as a temperature logger only. The DS2422 measures the temperature and/or reads the ADC at a user-defined rate. A total of 8192 8-bit readings or 4096 16-bit readings taken at equidistant intervals ranging from 1 second to 273 hours can be stored. In addition to this, there are 512 bytes of SRAM for storing application specific information and 64 bytes for calibration data. A mission to collect data can be programmed to begin immediately, after a user-defined delay, or after a temperature alarm. Access to the memory and control functions can be password-protected. The DS2422 is configured and communicates with a host computing device through the serial 1-Wire protocol, which requires only a single data lead and a ground return. Every DS2422 is factory-lasered with a guaranteed unique 64-bit registration number that allows for absolute traceability. The extremely low energy consumption in conjunction with its high level of programmability makes the DS2422 the ideal choice for low-cost data loggers that can take millions of measurements from the energy of a single 3V button cell.

APPLICATION

The DS2422 allows the design of data loggers or monitors with a minimum number of components. The simple circuit of Figure 1 can monitor body or room temperature with 0.0625°C resolution. For very high temperature-monitoring applications, a thermocouple can be connected to the analog-to-digital converter (ADC) through a pre-amplifier, as shown in Figure 2. The internal temperature sensor of the DS2422 keeps track of the reference temperature, which is needed to accurately convert the voltage reading of the thermocouple into the actual temperature of the monitored object. A less obvious application of the DS2422 is inside of major equipment. Besides the temperature inside the chassis, the serial interface can monitor up to 16 digital signals, which are parallel-clocked into an external shift register by CNVST and then shifted into the DS2422 through the SDATA pin

under the control of SCLK. The DS2422 will activate its alarm output if the measured temperature or serial-input data reaches a user-programmed high or low alarm threshold. This alarm then can be used to shut down the equipment and enforce a service call. In contrast to microprocessor-based data loggers, the DS2422 does not require any firmware development. Software for setup and data retrieval through the 1-Wire interface is available for free download from the iButton website (www.ibutton.com). This software also includes drivers for the serial and USB port 1-Wire interfaces of a PC, and routines to access the general-purpose memory for storing application or equipment-specific data files.

Figure 1. Simple Temperature Logger

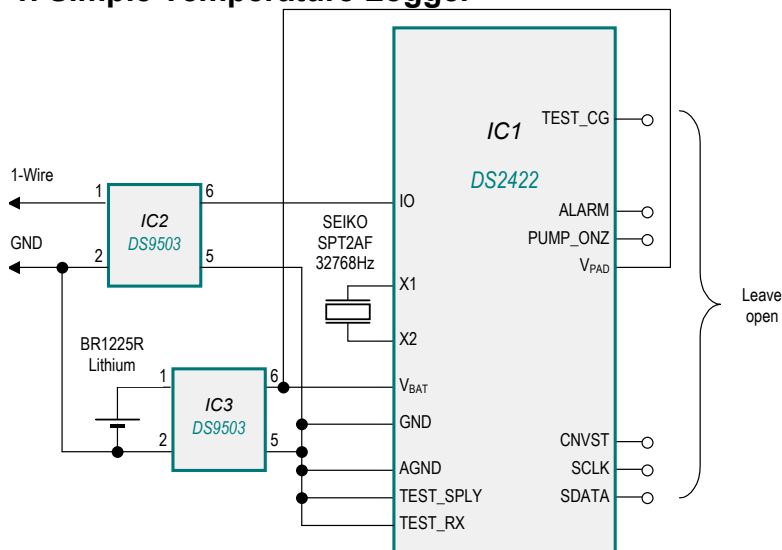
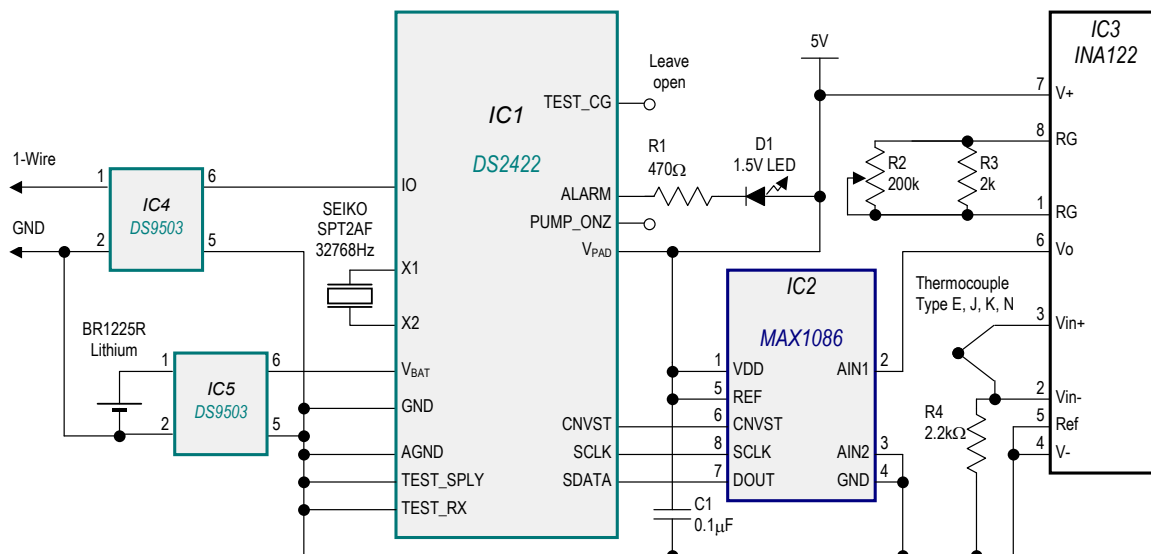
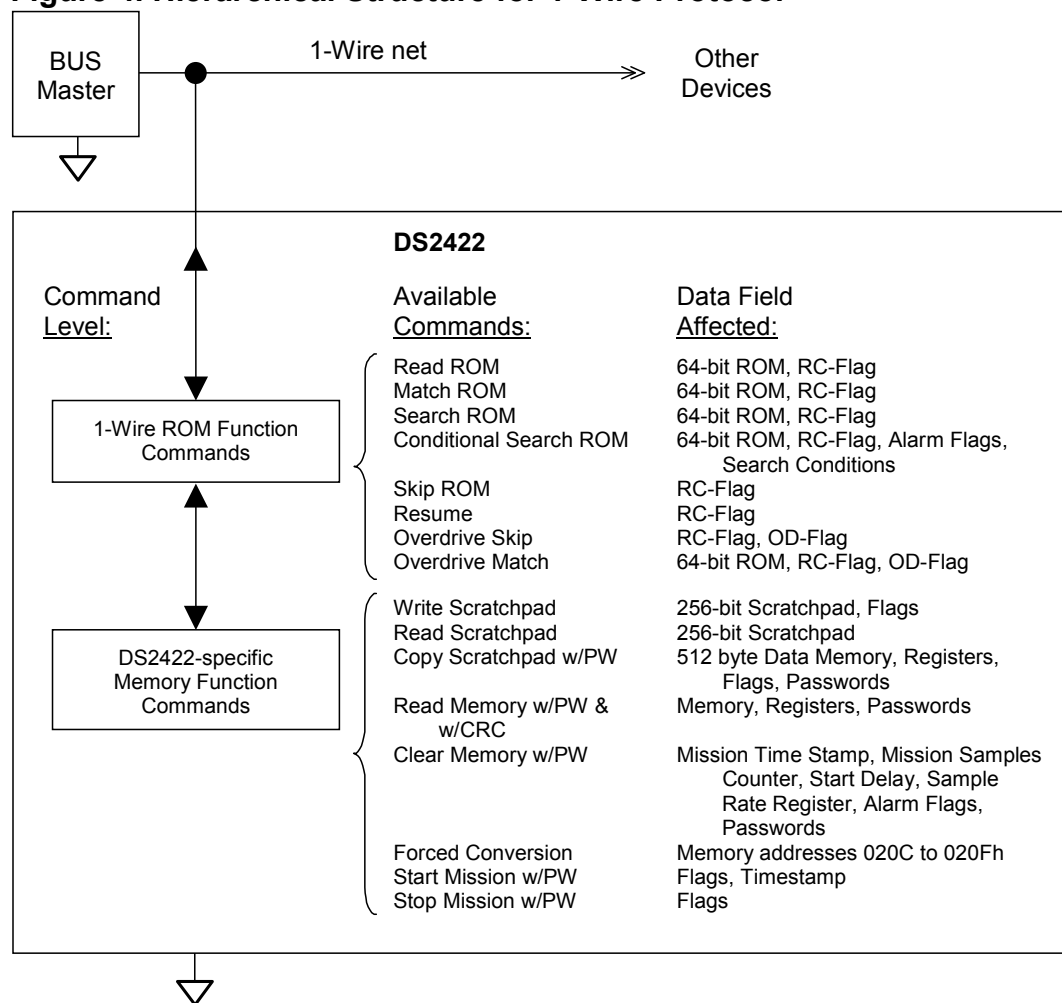

Figure 2. Temperature and Voltage Logger With Thermocouple



Note: When using a positive/negative thermocouple, an offset voltage can be utilized through the Ref input of the INA122 amplifier. This voltage shifts the 0V output of the amplifier up the amount equal to the offset voltage allowing negative voltages to be read in the positive range of the MAX1086. This offset voltage may be obtained through a simple resistor divider network (not shown).

Figure 4. Hierarchical Structure for 1-Wire Protocol

PARASITE POWER

The block diagram (Figure 3) shows the parasite-powered circuitry. This circuitry “steals” power whenever the I/O input is high. I/O provides sufficient power as long as the specified timing and voltage requirements are met. The advantages of parasite power are two-fold: 1) by parasiting off this input, battery power is conserved; and 2) if the battery is exhausted for any reason, the ROM may still be read.

64-BIT LASERED ROM

Each DS2422 contains a unique ROM code that is 64 bits long. The first 8 bits are a 1-Wire family code. The next 48 bits are a unique serial number. The last 8 bits are a CRC of the first 56 bits. See Figure 5 for details. The 1-Wire CRC is generated using a polynomial generator consisting of a shift register and XOR gates as shown in Figure 6. The polynomial is $X^8 + X^5 + X^4 + 1$. Additional information about the Dallas 1-Wire CRC is available in *Application Note 27* and in the *Book of DS19xx iButton Standards*.

The shift register bits are initialized to 0. Then starting with the least significant bit of the family code, one bit at a time is shifted in. After the 8th bit of the family code has been entered, then the serial number followed by the temperature range code is entered. After the range code has been entered, the shift register contains the CRC value. Shifting in the 8 bits of CRC returns the shift register to all 0s.

Figure 5. 64-Bit Lasered ROM

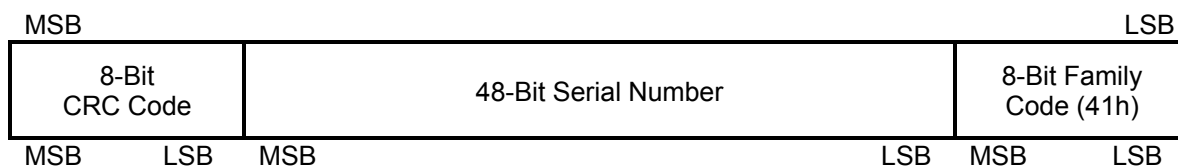

Figure 6. 1-Wire CRC Generator

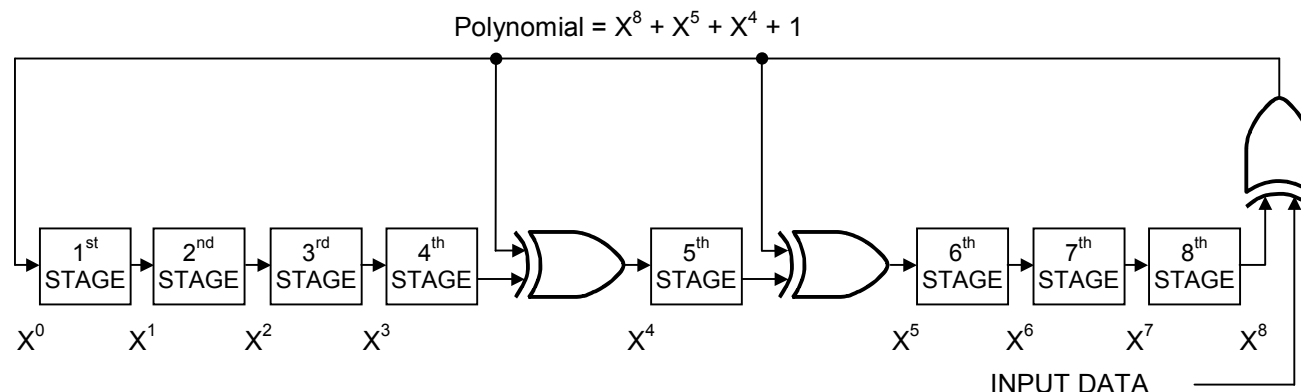

Figure 7. DS2422 Memory Map

32-Byte Intermediate Storage Scratchpad		
ADDRESS		
0000H to 001FH	32-Byte General-Purpose SRAM (R/W)	Page 0
0020H to 01FFH	General-Purpose SRAM (R/W)	Pages 1 to 15
0200H to 021FH	32-Byte Register Page 1	Page 16
0220H to 023FH	32-Byte Register Page 2	Page 17
0240H to 025FH	Calibration Memory Page 1 (R/W)	Page 18
0260H to 027FH	Calibration Memory Page 2 (R/W)	Page 19
0280H to 03FFH	(Reserved For Future Extensions)	Pages 20 to 31
0400H to 041FH	Trim Register Page (R/W)	Page 32
0420H to 0FFFH	(Reserved For Future Extensions)	Pages 33 to 127
1000H to 2FFFH	Datalog Memory (Read-Only)	Pages 128 to 383

MEMORY

The memory map of the DS2422 is shown in Figure 7. The 512 bytes general-purpose SRAM are located in pages 0 through 15. The various registers to set up and control the device fill page 16 and 17, called Register Pages 1 and 2 (details in Figure 8). Pages 18 and 19 provide storage space for calibration data. They can alternatively be used as extension of the general-purpose memory. The Trim Register Page holds registers that are used to tune the timing of the serial data interface and to trim the on-chip temperature converter. The "datalog" logging memory starts at address 1000h (page 128) and extends over 256 pages. The memory pages 20 to 31 and 33 to 127 are reserved for future extensions. The scratchpad is an additional page that acts as a buffer when writing to the SRAM memory or the register page. The data- and calibration memory can be written at any time. The access type for the two register pages and the Trim Register Page is register-specific and depends on whether the device is programmed for a mission. Figures 8A and 8B show the details. The datalog memory is read-only for the user. It is written solely under supervision of the on-chip control logic. Due to the special behavior of the write access logic (write scratchpad, copy scratchpad) it is recommended to only write full pages at a time. This also applies to all the register pages and the calibration memory. See section *Address Register and Transfer Status* for details.

Figure 8A. DS2422 Register Pages Map

ADDR	b7	b6	b5	b4	b3	b2	b1	b0	Function	Access*	
0200h	0	10 Seconds			Single Seconds					Real-Time Clock Registers	R/W; R
0201h	0	10 Minutes			Single Minutes						
0202h	0	12/24	20h. AM/PM	10h.	Single Hours						
0203h	0	0	10 Date		Single Date						
0204h	CENT	0	0	10m.	Single Months						
0205h	10 Years				Single Years						
0206h	Low Byte								Sample Rate	R/W; R	
0207h	0	0	High Byte								
0208h	Low Threshold								Temp. Alarms	R/W; R	
0209h	High Threshold										
020Ah	Low Threshold								Data Alarms	R/W; R	
020Bh	High Threshold										
020Ch	Low Byte			0	0	0	0	0	Latest Temp.	R; R	
020Dh	High Byte										
020Eh	Low Byte								Latest Data	R; R	
020Fh	High Byte										
0210h	0	0	0	0	0	0	ETHA	ETLA	T.Alm.En.	R/W; R	
0211h	1	1	1	1	1	1	EDHA	EDLA	D.Alm.En.	R/W; R	
0212h	0	0	0	0	0	0	EHSS	EOSC	RTC En.	R/W; R	
0213h	1	1	SUTA	RO	DLFS	TLFS	EDL	ETL	Mis. Cntrl.	R/W; R	
0214h	BOR	1	1	1	DHF	DLF	THF	TLF	Alm. Stat.	R; R	
0215h	1	1	0	WFTA	MEMC LR	0	MIP	0	Gen. Stat.	R; R	
0216h	Low Byte								Start Delay Counter	R/W; R	
0217h	Center Byte										
0218h	High Byte										
0219h	0	10 Seconds			Single Seconds					Mission Time Stamp	R; R
021Ah	0	10 Minutes			Single Minutes						
021Bh	0	12/24	20h. AM/PM	10h.	Single Hours						
021Ch	0	0	10 Date		Single Date						
021Dh	CENT	0	0	10m.	Single Months						
021Eh	10 Years				Single Years						
021Fh	(no function; reads 00h)								(N/A)	R; R	
0220h	Low Byte								Mission Samples Counter	R; R	
0221h	Center Byte										
0222h	High Byte										
0223h	Low Byte								Device Samples Counter	R; R	
0224h	Center Byte										
0225h	High Byte										
0226h	Configuration Code								Flavor	R; R	
0227h	EPW								PW. Cntrl.	R/W; R	

ADDR	b7	b6	b5	b4	b3	b2	b1	b0	Function	Access*
0228h	First Byte								Read Access Password	W; —
—	—									
022Fh	Eighth Byte								Full Access Password	W; —
0230h	First Byte									
—	—								Full Access Password	W; —
0237h	Eighth Byte									
0238h	(no function; all of these bytes read 00h)								(N/A)	R; R
—										
023Fh										

Figure 8B. DS2422 Trim Register Page Map

ADDR	b7	b6	b5	b4	b3	b2	b1	b0	Function	Access*
0400h	delay value								t_{SP}	R/W; R
0401h	(no function; undefined read)								(N/A)	R; R
—										
0403h	Temperature Counter Reset Low Byte									R/W; R/W
0404h										
0405h	0	0	0	Temperature Counter Reset High Byte						R/W; R/W
0406h	Temperature Conversion Length Low Byte									
0407h	0	0	0	Temperature Conversion Length High Byte						R/W; R/W
0408h	(no function; undefined read)									
—										
041Fh										

Note: The first entry in column ACCESS TYPE is valid between missions. The second entry shows the applicable access type while a mission is in progress.

TIMEKEEPING AND CALENDAR

The RTC and calendar information is accessed by reading/writing the appropriate bytes in the register page, address 200h to 205h. For readings to be valid, all RTC registers must be read sequentially starting at address 0200h. Some of the RTC bits are set to 0. These bits always read 0 regardless of how they are written. The number representation of the RTC registers is BCD format (binary-coded decimal).

Real-Time Clock Register Bitmap

ADDR	b7	b6	b5	b4	b3	b2	b1	b0
0200h	0	10s			Single Seconds			
0201h	0	10 min.			Single Minutes			
0202h	0	12/24	20hr AM/PM	10hr	Single Hours			
0203h	0	0	10 Date		Single Date			
0204h	CENT	0	0	10m.	Single Months			
0205h	10yrs				Single Years			

The RTC of the DS2422 can run in either 12-hour or 24-hour mode. Bit 6 of the Hours Register (address 202h) is defined as the 12- or 24-hour mode select bit. When high, the 12-hour mode is selected. In the 12-hour mode, bit 5 is the AM/PM bit with logic 1 being PM. In the 24-hour mode, bit 5 is the 20-hour bit (20 to 23 hours). The CENT bit, bit 7 of the Months Register, can be written by the user. This bit changes its state when the years counter transitions from 99 to 00.

The calendar logic is designed to automatically compensate for leap years. For every year value that is either 00 or a multiple of 4 the device adds a 29th of February. This works correctly up to (but not including) the year 2100.

SAMPLE RATE

The content of the Sample Rate Register (addresses 0206h, 0207h) specifies the time elapse (in seconds if EHSS = 1, or minutes if EHSS = 0) between two temperature/data logging events. The sample rate may be any value from 1 to 16383, coded as an unsigned 14-bit binary number. If EHSS = 1, the shortest time between logging events is 1 second and the longest (sample rate = 3FFFh) is 4.55 hours. If EHSS = 0, the shortest is 1 minute and the longest time is 273.05 hours (sample rate = 3FFFh). The EHSS bit is located in the RTC Control Register at address 0212h. It is important that the user sets the EHSS bit accordingly while setting the Sample Rate register. Writing a sample rate of 0000h results in a sample rate = 0001h, causing the DS2422 to log either every minute or every second depending upon the state of the EHSS bit.

Sample Rate Register Bitmap

ADDR	b7	b6	b5	b4	b3	b2	b1	b0
0206h	Sample Rate Low							
0207h	0	0	Sample Rate High					

During a mission, there is only read access to these registers. Bits cells marked "0" always read 0 and cannot be written to 1.

TEMPERATURE CONVERSION

The DS2422 can measure temperatures from -40°C to +85°C. Temperature values are represented as an 8- or 16-bit unsigned binary number with a resolution of 0.5°C in the 8-bit mode and 0.0625°C in the 16-bit mode.

The higher temperature byte TRH is always valid. In the 16-bit mode only the three highest bits of the lower byte TRL are valid. The five lower bits all read zero. TRL is undefined if the device is in 8-bit temperature mode. An out-of-range temperature reading is indicated as 00h or 0000h when too cold and FFh or FFE0h when too hot.

Latest Temperature Conversion Result Register Bitmap

ADDR	b7	b6	b5	b4	b3	b2	b1	b0	TRL	TRH
020Ch	T2	T1	T0	0	0	0	0	0		
020Dh	T10	T9	T8	T7	T6	T5	T4	T3		

With TRH and TRL representing the decimal equivalent of a temperature reading the temperature value is calculated as

$$\vartheta(^{\circ}\text{C}) = \text{TRH}/2 - 41 + \text{TRL}/512 \quad (16 \text{ bit mode, TLFS} = 1, \text{ see address } 0213\text{h})$$

$$\vartheta(^{\circ}\text{C}) = \text{TRH}/2 - 41 \quad (8 \text{ bit mode, TLFS} = 0, \text{ see address } 0213\text{h})$$

This equation is valid for converting temperature readings stored in the datalog memory as well as for data read from the Latest Temperature Conversion Result Register.

To specify the temperature alarm thresholds, the equation above needs to be resolved to

$$\text{TALM} = 2 * \vartheta(^{\circ}\text{C}) + 82$$

Since the temperature alarm threshold is only one byte, the resolution or temperature increment is limited to 0.5°C. The TALM value needs to be converted into hexadecimal format before it can be written to one of the temperature alarm threshold registers (**Low Alarm address 0208h; High Alarm address 0209h**). Independent of the conversion mode (8 or 16 bit) only the most significant byte of a temperature conversion is used to determine whether an alarm will be generated.

Temperature Conversion Examples

Mode	TRH		TRL		$\vartheta(^{\circ}\text{C})$
	hex	decimal	hex	decimal	
8-bit	54h	84	—	—	1.0
8-bit	17h	23	—	—	-29.5
16-bit	54h	84	00h	0	1.000
16-bit	17h	23	60h	96	-29.3125

Temperature Alarm Threshold Examples

θ (°C)	TALM	
	hex	decimal
25.5	85h	133
-10.0	3Eh	62

SERIAL DATA INPUT

In addition to temperature, the DS2422 can log 8-bit or 16-bit digital information that it receives through its serial interface. This interface is designed to directly connect to ADCs such as the MAX1086 or other circuits that use the same interface timing. The general timing of the serial interface is shown in Figure 9. All timing is derived from an on-chip ring oscillator, which generates the CLK signal. The CNVST signal is intended to start an analog-to-digital conversion. After the conversion is completed, the SCLK signal becomes active and on its rising edge clocks the digital value into the DS2422. The PUMP_ONZ signal can activate a MAX619 charge pump to convert the 3V battery voltage of the DS2422 into 5V, for example, to power additional circuitry.

Figure 9A. Serial Interface Timing

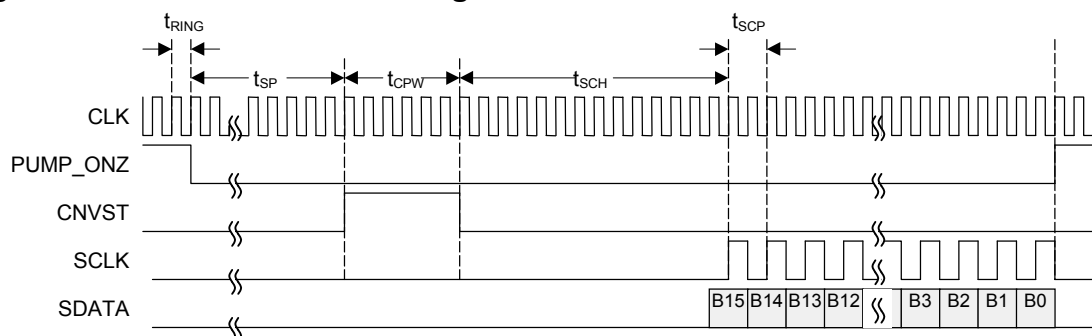
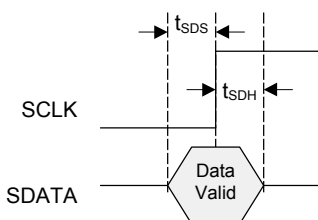

Figure 9B. Serial Interface Setup and Hold Timing



The serial interface becomes active whenever the DS2422 executes a Forced Conversion command (see *Memory/Control Function Commands*) or during a mission, if the device is set up to log data from its serial interface. Regardless of its setup, the DS2422 always reads 16 bits from its serial input. **The 16-bit result of the latest serial reading is found at address 020Eh (low byte) and 020Fh (high byte).** The first bit read through the serial interface is always found as B15 at address 020Fh. If an ADC generates less than 16 bits, the internal weak pulldown of the SDATA pin makes the missing bits read zero.

Latest Serial Data Reading Result Register Bitmap

ADDR	b7	b6	b5	b4	b3	b2	b1	b0	
020Eh	B7	B6	B5	B4	B3	B2	B1	B0	LOW HIGH
020Fh	B15	B14	B13	B12	B11	B10	B9	B8	

During a mission, if data logging from the serial input is enabled, the HIGH byte (B15 to B8) is always recorded. The LOW byte (B7 to B0) is only recorded if the DS2422 is set up for 16-bit logging of serial input data.

The algorithm to convert the digital reading from the serial interface into a physical unit depends on the circuit that provides the data to the DS2422. This algorithm needs to be reversed when calculating values for the alarm threshold registers that are associated to the serial data input. **The registers for data alarm thresholds are located at address 020Ah (Low Alarm) and 020B (High Alarm).** The comparison is based on the most significant serial input byte and assumes that the data is represented as unsigned binary number.

TEMPERATURE SENSOR ALARM

The DS2422 has two **Temperature Alarm Threshold registers (address 0208h, 0209h)** to store values, which determine whether a critical temperature has been reached. A temperature alarm is generated if the device measures an alarming temperature AND the alarm signaling is enabled. The bits ETLA and ETHA that enable the temperature alarm are located in the Temperature Sensor Control Register. The temperature alarm flags TLF and THF are found in the Alarm Status Register at address 0214h.

Temperature Sensor Control Register Bitmap

ADDR	b7	b6	b5	b4	b3	b2	b1	b0
0210h	0	0	0	0	0	0	ETHA	ETLA

During a mission, there is only read access to this register. Bits 2 to 7 have no function. They always read 0 and cannot be written to 1.

Register Details

BIT DESCRIPTION	BIT(S)	DEFINITION
ETLA: Enable Temperature Low Alarm	b0	This bit controls whether, during a mission, the Temperature Low Alarm Flag TLF may be set, if a temperature conversion results in a value equal to or lower than the value in the Temperature Low Alarm Threshold Register. If ETLA is 1, temperature low alarms are enabled. If ETLA is 0, temperature low alarms are not generated.
ETHA: Enable Temperature High Alarm	b1	This bit controls whether, during a mission, the Temperature High Alarm Flag THF may be set, if a temperature conversion results in a value equal to or higher than the value in the Temperature High Alarm Threshold Register. If ETHA is 1, temperature high alarms are enabled. If ETHA is 0, temperature high alarms are not generated.

SERIAL INPUT ALARM

The DS2422 has two **Data Alarm Threshold registers (address 020Ah, 020Bh)** to store values, which determine whether data read through the serial interface can generate an alarm. Such an alarm is generated if the input data qualifies for an alarm AND the alarm signaling is enabled. The bits EDLA and EDHA that enable the serial input alarm are located in the DATA_IF Control Register. The corresponding alarm flags DLF and DHF are found in the Alarm Status Register at address 0214h.

DATA_IF Control Register Bitmap

ADDR	b7	b6	b5	b4	b3	b2	b1	b0
0211h	1	1	1	1	1	1	EDHA	EDLA

During a mission, there is only read access to this register. Bits 3 to 7 have no function. They always read 1 and cannot be written to 0.

Register Details

BIT DESCRIPTION	BIT(S)	DEFINITION
EDLA: Enable Data Low Alarm	b0	This bit controls whether, during a mission, the Data Low Alarm Flag DLF may be set, if a data value from the serial data interface is equal to or lower than the value in the Data Low Alarm Threshold Register. If EDLA is 1, data low alarms are enabled. If EDLA is 0, data low alarms are not generated.
EDHA: Enable Data High Alarm	b1	This bit controls whether, during a mission, the Data High Alarm Flag DHF may be set, if a data value from the serial data interface is equal to or higher than the value in the Data High Alarm Threshold Register. If EDHA is 1, data high alarms are enabled. If EDHA is 0, data high alarms are not generated.

REAL-TIME CLOCK CONTROL

To minimize the power consumption of a battery-operated datalogger, the RTC oscillator should be turned off when device is not in use. The oscillator on/off bit is located in the RTC control register. This register also includes the EHSS bit, which determines whether the sample rate is specified in seconds or minutes.

RTC Control Register Bitmap

ADDR	b7	b6	b5	b4	b3	b2	b1	b0
0212h	0	0	0	0	0	0	EHSS	EOSC

During a mission, there is only read access to this register. Bits 2-7 have no function. They always read 0 and cannot be written to 1.

Register Details

BIT DESCRIPTION	BIT(S)	DEFINITION
EOSC: Enable Oscillator	b0	This bit controls the crystal oscillator of the RTC. When set to logic 1, the oscillator will start operation. When written to logic 0, the oscillator stops and the device is in a low-power data retention mode. This bit must be 1 for normal operation. A Forced Conversion or Start Mission command automatically starts the RTC by changing the EOSC bit to logic 1.
EHSS: Enable High Speed Sample	b1	This bit controls the speed of the Sample Rate counter. When set to logic 0, the sample rate is specified in minutes. When set to logic 1, the sample rate is specified in seconds.

MISSION CONTROL

The DS2422 is set up for its operation by writing appropriate data to its special function registers, which are located in the two register pages. The settings in the Mission Control Register determine whether temperature and/or external data is logged, which format (8 or 16 bits) is to be used and whether old data may be overwritten by new data, once the datalog memory is full. An additional control bit can be set to tell the DS2422 to wait with logging data until a temperature alarm is encountered.

Mission Control Register Bitmap

ADDR	b7	b6	b5	b4	b3	b2	b1	b0
0213h	1	1	SUTA	RO	DLFS	TLFS	EDL	ETL

During a mission, there is only read access to this register. Bits 6 and 7 have no function. They always read 1 and cannot be written to 0.

Register Details

BIT DESCRIPTION	BIT(S)	DEFINITION
ETL: Enable Temperature Logging	b0	To set up the device for a temperature-logging mission, this bit must be set to logic 1. To successfully start a mission, ETL or EDL must be 1. If temperature logging is enabled, the recorded temperature values will always be stored starting at address 1000h.
EDL: Enable Data Logging	b1	To set up the device for a data-logging mission (recording data from serial data interface), this bit must be set to logic 1. To successfully start a mission, ETL or EDL must be 1. If only data logging is enabled (no temperature data), the recorded data values will be stored starting at address 1000h. If both, temperature and data logging are enabled, the recorded data values will begin at address 2000h (TLFS = DLFS) or 1A00h (TLFS = 0; DLFS = 1) or 2400h (TLFS = 1; DLFS = 0).
TLFS: Temperature Logging Format Selection	b2	This bit specifies the format used to store temperature readings in the datalog memory. If this bit is 0, the data will be stored in 8-bit format. If this bit is 1, the 16-bit format will be used (higher resolution). With 16-bit format, the most-significant byte is stored at the lower address.
DLFS: Data Logging Format Selection	b3	This bit specifies the format used to store data readings from the serial data interface in the datalog memory. If this bit is 0, the data will be stored in 8-bit format. If this bit is 1, the 16-bit format will be used (higher resolution). With 16-bit format, the most-significant byte is stored at the lower address.
RO: Rollover Control	b4	This bit controls whether, during a mission, the datalog memory is overwritten with new data or whether data logging is stopped once the datalog memory is full. Setting this bit to 1 enables the rollover and data logging continues at the beginning, overwriting previously collected data. If this bit is 0, the logging and conversions will stop once the datalog memory is full. However, the RTC will continue to run and the MIP bit will remain set until the Stop Mission command is performed.
SUTA: Start Mission upon Temperature Alarm	b5	This bit specifies whether a mission begins immediately (includes delayed start) or if a temperature alarm will be required to start the mission. If this bit is 1, the device will perform an 8-bit temperature conversion at the selected sample rate and begin with data logging only if an alarming temperature (high alarm or low alarm) was found. The first logged temperature is when the alarm occurred. However, the mission sample counter does not increment. This functionality is guaranteed by design and not production tested.

ALARM STATUS

The fastest way to determine whether a programmed alarm threshold was exceeded during a mission is through reading the Alarm Status Register. In a networked environment that contains multiple DS2422-based dataloggers the devices that encountered an alarm can quickly be identified by means of the Conditional Search command (see *ROM Function Commands*). The data and temperature alarm only occurs if enabled (see *Temperature Sensor Alarm* and *Serial Input Alarm*). The BOR alarm is always enabled.

Alarm Status Register Bitmap

ADDR	b7	b6	b5	b4	b3	b2	b1	b0
0214h	BOR	1	1	1	DHF	DLF	THF	TLF

There is only read access to this register. Bits 4 to 6 have no function. They always read 1. All five alarm status bits are cleared simultaneously when the Clear Memory function is invoked. See *Memory and Control Functions* for details.

Register Details

BIT DESCRIPTION	BIT(S)	DEFINITION
TLF: Temperature Low Alarm Flag	b0	If this bit reads 1, there was at least one temperature conversion during a mission revealing a temperature equal to or lower than the value in the Temperature Low Alarm Register. A forced conversion can affect the TLF bit. This bit can also be set with the initial alarm in the SUTA = 1 mode.
THF: Temperature High Alarm Flag	b1	If this bit reads 1, there was at least one temperature conversion during a mission revealing a temperature equal to or higher than the value in the Temperature High Alarm Register. A forced conversion can affect the THF bit. This bit can also be set with the initial alarm in the SUTA = 1 mode.
DLF: Data Low Alarm Flag	b2	If this bit reads 1, there was at least one data value read from the serial data interface during a mission revealing a value equal to or lower than the value in the Data Low Alarm Register. A forced conversion can affect the DLF bit.
DHF: Data High Alarm Flag	b3	If this bit reads 1, there was at least one data value read from the serial data interface during a mission revealing a value equal to or higher than the value in the Data High Alarm Register. A forced conversion can affect the DHF bit.
BOR: Battery On Reset Alarm	b7	If this bit reads 1, the device has performed a power-on-reset. This occurs when the V_{BAT} power source gets first connected at assembly or when the power supply gets interrupted. The trim settings need to be restored for proper function. Any data found in the datalog memory should be disregarded.

GENERAL STATUS

The information in the general status register tells the host computer whether a mission-related command was executed successfully. Individual status bits indicate whether the DS2422 is performing a mission, waiting for a temperature alarm to trigger the logging of data or whether the data from the latest mission has been cleared.

General Status Register Bitmap

ADDR	b7	b6	b5	b4	b3	b2	b1	b0
0215h	1	1	0	WFTA	MEMCLR	0	MIP	0

There is only read access to this register. Bits 0, 2, 5, 6, and 7 have no function.

Register Details

BIT DESCRIPTION	BIT(S)	DEFINITION
MIP: Mission In Progress	b1	If this bit reads 1 the device has been set up for a mission and this mission is still in progress. The MIP bit returns from logic 1 to logic 0 when a mission is ended. See function commands Start Mission and Stop Mission.
MEMCLR: Memory Cleared	b3	If this bit reads 1, the Mission Time Stamp, Mission Samples Counter, as well as all the alarm flags of the Alarm Status Register have been cleared in preparation of a new mission. Executing the Clear Memory command clears these memory sections. The MEMCLR bit will return to 0 as soon as a new mission is started by using the Start Mission command. The memory has to be cleared in order for a mission to start.
WFTA: Waiting for Temperature Alarm	b4	If this bit reads 1, the Mission Start upon Temperature Alarm was selected and the Start Mission command was successfully executed, but the device has not yet experienced the temperature alarm. This bit is cleared after a temperature alarm event, but is not affected by the Clear Memory command. Once set, WFTA remains set if a mission is stopped before a temperature alarm occurs. To clear WFTA manually before starting a new mission, set the high temperature alarm (address 0209h) to -40°C and perform a forced conversion.

MISSION START DELAY

The content of the Mission Start Delay Counter tells how many minutes will have to expire from the time a mission was started until the first measurement of the mission will take place (SUTA = 0) or until the device will start testing the temperature for a temperature alarm (SUTA = 1). The Mission Start Delay is stored as an unsigned 24-bit integer number. The maximum delay is 16777215 minutes, equivalent to 11650 days or roughly 31 years. If the start delay is non-zero and the SUTA bit is set to 1, first the delay has to expire before the device starts testing for temperature alarms to begin logging data.

Mission Start Delay Counter

ADDR	b7	b6	b5	b4	b3	b2	b1	b0
0216h	Delay Low Byte							
0217h	Delay Center Byte							
0218h	Delay High Byte							

During a mission, there is only read access to these registers.

For a typical mission, the Mission Start Delay is 0. If a mission is too long for a single DS2422 to store all readings at the selected sample rate, one can use several devices and set the Mission Start Delay for the second device to start recording as soon as the memory of the first device is full, and so on. The RO-bit in the Mission Control Register (address 0213h) must be set to 0 to prevent overwriting of collected data once the datalog memory is full.

MISSION TIME STAMP

The Mission Time Stamp indicates the date and time of the first logged temperature and/or data sample of the mission. There is only read access to the Mission Time Stamp Register.

Mission Time Stamp Registers Bitmap

ADDR	b7	b6	b5	b4	b3	b2	b1	b0
0219h	0	10 Seconds			Single Seconds			
021Ah	0	10 Minutes			Single Minutes			
021Bh	0	12/24	20h. AM/PM	10h.	Single Hours			
021Ch	0	0	10 Date		Single Date			
021Dh	CENT	0	0	10m.	Single Months			
021Eh	10 Years			Single Years				

MISSION PROGRESS INDICATOR

Depending on settings in the Mission Control Register (address 0213h) the DS2422 will log temperature and/or serial input data in 8-bit or 16-bit format. The description of the ETL and EDL bit explains where the device stores data in its datalog memory. The Mission Samples Counter together with the starting address and the logging format (8 or 16 bits) provides the information to identify valid blocks of data that have been gathered during the current (MIP = 1) or latest mission (MIP = 0). See *Datalog Memory Usage* for an illustration.

Mission Samples Counter Register Map

ADDR	b7	b6	b5	b4	b3	b2	b1	b0
0220h	Low Byte							
0221h	Center Byte							
0222h	High Byte							

There is only read access to this register. Note that when both the internal temperature and serial input logging are enabled, the two logs are counted as one event in the **Mission Samples Counter** and **Device Samples Counter**.

The number read from the Mission Samples Counter indicates how often the DS2422 woke up during a mission to measure temperature and/or read data from its serial interface. The number format is 24-bit unsigned integer. The Mission Samples Counter is reset through the Clear Memory command.

OTHER INDICATORS

The Device Samples Counter is similar to the Mission Samples Counter. During a mission this counter increments whenever the DS2422 wakes up to measure and log data and when the device is testing for a temperature alarm in SUTA mode. Between missions the counter increments whenever the Forced Conversion command is executed. This way the Device Samples Counter functions like a gas gauge for the battery that powers the chip.

Device Samples Counter Register Map

ADDR	b7	b6	b5	b4	b3	b2	b1	b0
0223h	Low Byte							
0224h	Center Byte							
0225h	High Byte							

There is only read access to this register.

The Device Samples Counter is reset to zero when the battery is connected to the V_{BAT} pin. The number format is 24-bit unsigned integer. The maximum number that can be represented in this format is 16777215.

The Device Configuration Byte is used to allow the master to distinguish between the DS2422 chip and different versions of iButtons based on this chip. With the DS2422, this byte always reads 00h.

Device Configuration Byte

ADDR	b7	b6	b5	b4	b3	b2	b1	b0	Part
0226h	0	0	0	0	0	0	0	0	DS2422
	0	0	1	0	0	0	0	0	DS1923
	0	1	0	0	0	0	0	0	DS1922L
	0	1	1	0	0	0	0	0	DS1922T
	1	0	0	0	0	0	0	0	DS1922E

There is only read access to this register.

SECURITY BY PASSWORD

The DS2422 is designed to use two passwords that control read access and full access. Reading from or writing to the scratchpad as well as the forced conversion command does not require a password. The password needs to be transmitted right after the command code of the memory or control function. If password checking is enabled the password transmitted is compared to the passwords stored in the device. The data pattern stored in the Password Control register determines whether password checking is enabled.

Password Control Register

ADDR	b7	b6	b5	b4	b3	b2	b1	b0
0227h	EPW							

During a mission, there is only read access to this register.

To enable password checking, the EPW bits need to form a binary pattern of 10101010 (AAh). The default pattern of EPW is different from AAh. If the EPW pattern is different from AAh, any pattern is accepted, as long as it has a length of exactly 64 bits. Once enabled, changing the passwords and disabling password checking requires the knowledge of the current full-access password.

Before enabling password checking, passwords for read-only access as well as for full access (read/write/control) need to be written to the password registers. Setting up a password or enabling/disabling the password checking is done in the same way as writing data to a memory location, only the address is different. Since they are located in the same memory page, both passwords can be redefined at the same time.

Read Access Password Register

ADDR	b7	b6	b5	b4	b3	b2	b1	b0
0228h	RP7	RP6	RP5	RP4	RP3	RP2	RP1	RP0
0229h	RP15	RP14	RP13	RP12	RP11	RP10	RP9	RP8
—	—							
022Eh	RP55	RP54	RP53	RP52	RP51	RP50	RP49	RP48
022Fh	RP63	RP62	RP61	RP60	RP59	RP58	RP57	RP56

There is only write access to this register. Attempting to read the password reports all zeros. The password cannot be changed while a mission is in progress.

The Read Access Password needs to be transmitted exactly in the sequence RP0, RP1... RP62, RP63. This password only applies to the function "Read Memory with CRC". The DS2422 delivers the requested data only if the password transmitted by the master was correct or if password checking is not enabled.

Full Access Password Register

ADDR	b7	b6	b5	b4	b3	b2	b1	b0
0230h	FP7	FP6	FP5	FP4	FP3	FP2	FP1	FP0
0231h	FP15	FP14	FP13	FP12	FP11	FP10	FP9	FP8
—	—							
0236h	FP55	FP54	FP53	FP52	FP51	FP50	FP49	FP48
0237h	FP63	FP62	FP61	FP60	FP59	FP58	FP57	FP56

There is only write access to this register. Attempting to read the password will report all zeros. The password cannot be changed while a mission is in progress.

The Full Access Password needs to be transmitted exactly in the sequence FP0, FP1... FP62, FP63. It will affect the functions "Read Memory with CRC", "Copy Scratchpad", "Clear Memory", "Start Mission", and "Stop Mission". The DS2422 executes the command only if the password transmitted by the master was correct or if password checking is not enabled.

Due to the special behavior of the write access logic, the Password Control Register and both passwords must be written at the same time. When setting up new passwords, always verify (read back) the scratchpad before sending the copy scratchpad command. After a new password is successfully copied from the scratchpad to its memory location, erase the scratchpad by filling it with new data (write scratchpad command). Otherwise a copy of the passwords will remain in the scratchpad for public read access.

SERIAL DATA INTERFACE TUNING

The serial interface consists of several signals that are intended to control external circuitry, such as an analog-to-digital converter (see Figure 9A). There is one signal, called CNVST, which can be used to load data into a shift register or to trigger a data conversion. The delay t_{SP} from the activation of the serial interface (PUMP_ONZ) to CNVST is user-programmable through the Delay Register. When used with a charge pump such as the MAX619, the variable delay t_{SP} is used to give the charge pump adequate time to stabilize before a conversion starts. If no charge pump is used, the delay may be set to 00h to begin the conversion sooner.

Delay Register

ADDR	b7	b6	b5	b4	b3	b2	b1	b0
0400h	delay value							

During a mission, there is only read access to this register.

The Delay Register holds the preset value of a counter that determines the duration of t_{SP} . The number format is unsigned integer with values ranging from 0 to FFh (0 to 255 decimal). This is equivalent to a range from 0 to 127.5ms. The power-on value of this register is 08h.

TEMPERATURE CONVERTER TRIM

The DS2422 leaves the factory fully tested, but not trimmed for temperature accuracy. The actual trim values consist of two sets, Temperature Counter Reset and Temperature Conversion Length, which need to be determined individually for each device during a 2-point calibration step. These trim values need to be written to the respective registers in the Trim Register Page before the device meets the accuracy specification shown in the graphs at the beginning of this document.

Temperature Counter Reset Register

ADDR	b7	b6	b5	b4	b3	b2	b1	b0
0404h	Temperature Counter Reset Low Byte							
0405h	0	0	0	Temperature Counter Reset High Byte				

There is always full read/write access to this register. Bits 5-7 of the High Byte are always 0 and cannot be written to 1. The power-on default is 6Bh (0404h) and 11h (0405h).

The Temperature Counter Reset value provides a purely vertical shift along the Temperature Transfer Curve in order to reset the zero point. The algorithm to determine the correct Temperature Counter Reset value is included in Application Note 2810.

Temperature Conversion Length Register

ADDR	b7	b6	b5	b4	b3	b2	b1	b0
0406h	Temperature Conversion Length Low Byte							
0407h	0	0	0	Temp Conversion Length High Byte				

There is always full read/write access to this register. Bits 5-7 of the High Byte are always 0 and cannot be written to 1. The power-on default is A6h (0406h) and 12h (0407h).

The Temperature Conversion Length value provides a vertical and horizontal shift of the Temperature Transfer Curve. The algorithm to determine the correct Temperature Counter Reset value is included in Application Note 2810.

DATALOG MEMORY USAGE

Once setup for a mission, the DS2422 logs the temperature measurements and/or external data at equidistant time points entry after entry in its datalog memory. The datalog memory is able to store 8192 entries in 8-bit format or 4096 entries in 16-bit format (Figure 10A). If temperature as well as external data is logged, both in the same format, the memory is split into two equal sections that can store 4096 8-bit entries or 2048 16-bit entries (Figure 10B). If the device is set up to log data in different formats, e. g., temperature in 8-bit and external data in 16-bit format, the memory is split into blocks of different size, accommodating 2560 entries for either data source (Figure 10C). In this case, the upper 256 bytes are not used. In 16-bit format, the higher 8 bits of an entry are stored at the

lower address. Knowing the starting time point (Mission Time Stamp) and the interval between temperature measurements one can reconstruct the time and date of each measurement.

There are two alternatives to the way the DS2422 behaves after the datalog memory is filled with data. The user can program the device to either stop any further recording (disable “rollover”) or overwrite the previously recorded data (enable “rollover”), one entry at a time, starting again at the beginning of the respective memory section. The contents of the Mission Samples Counter in conjunction with the sample rate and the Mission Time Stamp will then allow reconstructing the time points of all values stored in the datalog memory. This gives the exact history over time for the most recent measurements taken. Earlier measurements cannot be reconstructed.

Figure 10A. One-Channel Logging

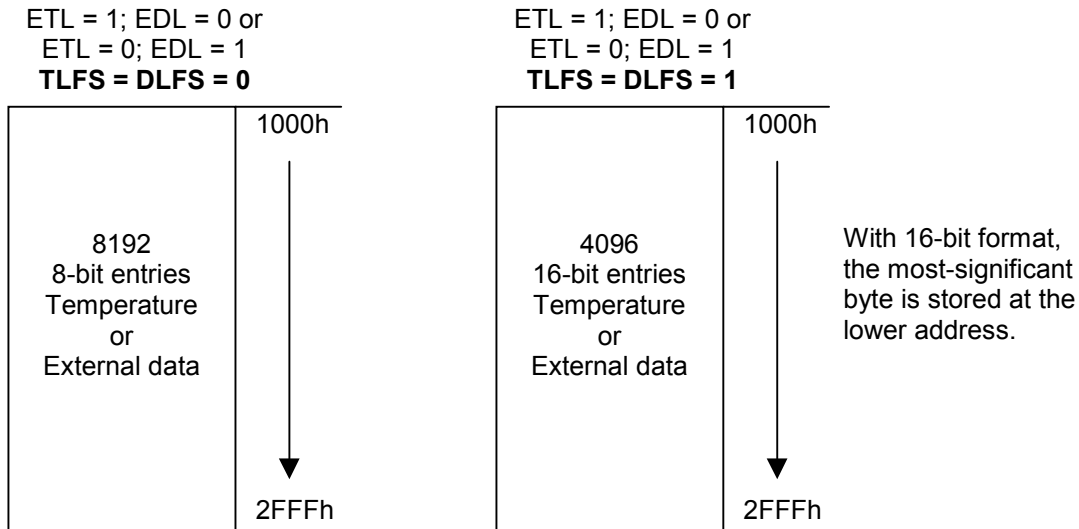

Figure 10B. Two-Channel Logging, Equal Resolution

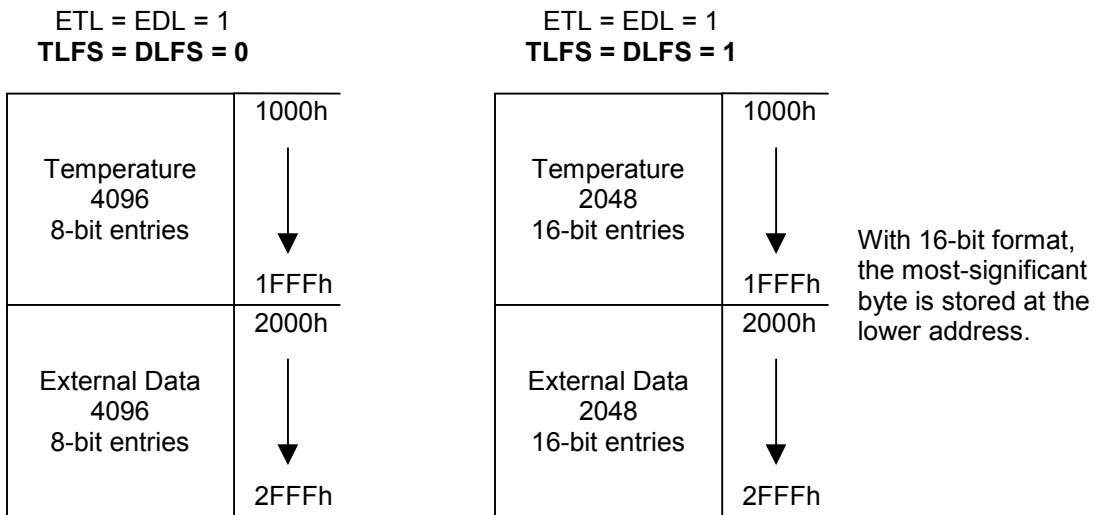
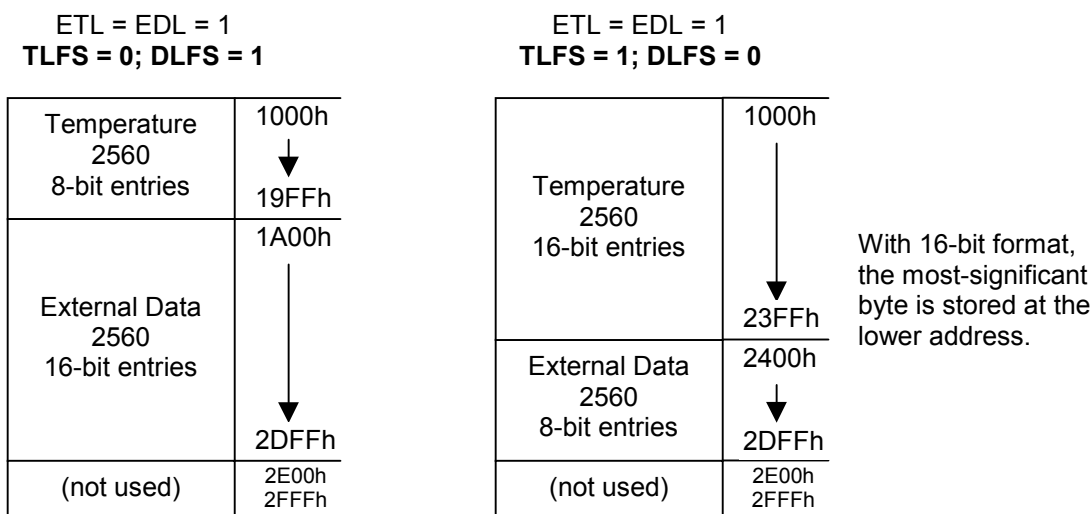

Figure 10C. Two-Channel Logging, Different Resolution

MISSIONING

The typical task of the DS2422 is recording temperature and/or external data. Before the device can perform this function, it needs to be set up properly. This procedure is called missioning.

First of all, DS2422 needs to have its RTC set to valid time and date. This reference time may be the local time, or, when used inside of a mobile unit, UTC (also called GMT, Greenwich Mean Time) or any other time standard that was agreed upon. The RTC oscillator must be running (EOSC = 1). The memory assigned to store the Mission Time Stamp, Mission Samples Counter, and Alarm Flags must be cleared using the Memory Clear command. To enable the device for a mission, at least one of the enable logging bits needs to be set to 1. These are general settings that have to be made in any case, regardless of the type of object to be monitored and the duration of the mission.

If alarm signaling is desired, the temperature alarm and/or data alarm low and high thresholds must be defined. How to convert a temperature value into the binary code to be written to the threshold registers is described under *Temperature Conversion* earlier in this document. Determining the thresholds for the data alarm depends on the hardware/converter that is connected to the DS2422's serial input. In addition, the temperature and/or data alarm must be enabled for the low- and/or high-threshold. This makes the device respond to a Conditional Search command (see *ROM Function Commands*), provided that an alarming condition has been encountered.

The setting of the RO bit (rollover enable) and sample rate depends on the duration of the mission and the monitoring requirements. If the most recently logged data is important, the rollover should be enabled (RO = 1). Otherwise one should estimate the duration of the mission in minutes and divide the number by 8192 (single channel 8-bit format) or 4096 (single channel 16-bit format, two channels 8-bit format) or 2048 (two channels 16-bit format) or 2560 (two channels, one 8-bit format and one 16-bit format) to calculate the value of the sample rate (number of minutes between temperature conversions). If the estimated duration of a mission is 10 days (= 14400 minutes), for example, then the 8192-byte capacity of the datalog memory would be sufficient to store a new 8-bit value every 1.8 minutes (110 seconds). If the datalog memory of the DS2422 is not large enough to store all readings, one can use several devices and set the Mission Start Delay to values that make the second device start logging as soon as the memory of the first device is full, and so on. The RO-bit needs to be set to 0 to disable rollover that would otherwise overwrite the logged data.

After the RO bit and the Mission Start Delay are set, the sample rate needs to be written to the Sample Rate Register. The sample rate may be any value from 1 to 16383, coded as an unsigned 14-bit binary number. The fastest sample rate is one sample per second (EHSS = 1, Sample Rate = 0001h) and the slowest is one sample every 273.05 hours (EHSS = 0, Sample Rate = 3 FFFh). To get one sample every 6 minutes, for example, the sample rate value needs to be set to 6 (EHSS = 0) or 360 decimal (equivalent to 0168h at EHSS = 1).

If there is a risk of unauthorized access to the DS2422 or manipulation of data, one should define passwords for read access and full access. Before the passwords become effective, their use needs to be enabled. See *Security by Password* for more details.

The last step to begin a mission is to issue the Start Mission command. As soon as it has received this command, the DS2422 sets the MIP flag and clear the MEMCLR flag. With the immediate/delayed start mode (SUTA = 0), after as many minutes as specified by the Mission Start Delay are over, the device wakes up, copy the current date and time to the mission time stamp register, and log the first entry of the mission. This increments both the Mission Samples Counter and Device Samples Counter. All subsequent log entries are made as specified by the value in the Sample Rate Register and the EHSS bit.

If the Start Upon Temperature Alarm mode is chosen (SUTA = 1, ETL = 1) the DS2422 will first wait until the start delay is over. Then the device wakes up in intervals as specified by the sample rate and EHSS bit and measure the temperature. This increments the device samples counter only. The first sample of the mission is logged when the temperature alarm occurred. However, the Mission Sample Counter does not increment. One sample period later the Mission Timestamp register is set. From then on, both the Mission Samples Counter and Device Samples Counter increments at the same time. All subsequent log entries are made as specified by the value in the Sample Rate Register and the EHSS bit.

The general-purpose memory operates independently of the other memory sections and is not write-protected during a mission. All memory of the DS2422 can be read at any time, e. g., to watch the progress of a mission. Attempts to read the passwords will read 00h bytes instead of the data that is stored in the password registers.

ADDRESS REGISTERS AND TRANSFER STATUS

Because of the serial data transfer, the DS2422 employs three address registers, called TA1, TA2, and E/S (Figure 11). Registers TA1 and TA2 must be loaded with the target address to which the data is written or from which data is sent to the master upon a Read command. Register E/S acts like a byte counter and transfer status register. It is used to verify data integrity with Write commands. Therefore, the master only has read access to this register. The lower 5 bits of the E/S Register indicate the address of the last byte that has been written to the scratchpad. This address is called Ending Offset. **The DS2422 requires that the Ending Offset is always 1Fh for a Copy Scratchpad to function.** Bit 5 of the E/S Register, called PF or “partial byte flag,” is set if the number of data bits sent by the master is not an integer multiple of 8. Bit 6 is always a 0. Note that the lowest 5 bits of the target address also determine the address within the scratchpad, where intermediate storage of data will begin. This address is called byte offset. If the target address for a Write command is 13Ch, for example, then the scratchpad will store incoming data beginning at the byte offset 1Ch and will be full after only 4 bytes. The corresponding ending offset in this example is 1Fh. For best economy of speed and efficiency, the target address for writing should point to the beginning of a new page, i.e., the byte offset will be 0. Thus the full 32-byte capacity of the scratchpad is available, resulting also in the ending offset of 1Fh. However, it is possible to write 1 or several contiguous bytes somewhere within a page. The ending offset together with the Partial and Overflow Flag is mainly a means to support the master checking the data integrity after a Write command. The highest valued bit of the E/S Register, called AA or Authorization Accepted, indicates that a valid copy command for the scratchpad has been received and executed. Writing data to the scratchpad clears this flag.

Figure 11. Address Registers

	Bit #	7	6	5	4	3	2	1	0
Target Address (TA1)		T7	T6	T5	T4	T3	T2	T1	T0
Target Address (TA2)		T15	T14	T13	T12	T11	T10	T9	T8
Ending Address with Data Status (E/S) (Read Only)		AA	0	PF	E4	E3	E2	E1	E0

WRITING WITH VERIFICATION

To write data to the DS2422, the scratchpad has to be used as intermediate storage. First the master issues the Write Scratchpad command to specify the desired target address, followed by the data to be written to the scratchpad. In the next step, the master sends the Read Scratchpad command to read the scratchpad and to verify data integrity. As preamble to the scratchpad data, the DS2422 sends the requested target address TA1 and TA2 and the contents of the E/S Register. If the PF flag is set, data did not arrive correctly in the scratchpad. The master does not need to continue reading; it can start a new trial to write data to the scratchpad. Similarly, a set AA flag indicates that the Write command was not recognized by the device. If everything went correctly, both flags are cleared and the ending offset indicates the address of the last byte written to the scratchpad. Now the master can continue verifying every data bit. After the master has verified the data, it has to send the Copy Scratchpad command. This command must be followed exactly by the data of the three address registers TA1, TA2 and E/S as the master has read them verifying the scratchpad. As soon as the DS2422 has received these bytes, it will copy the data to the requested location beginning at the target address.

MEMORY- AND CONTROL-FUNCTION COMMANDS

The “Memory/Control Function Flow Chart” (Figure 12) describes the protocols necessary for accessing the memory and the special function registers of the DS2422. An example on how to use these and other functions to set up the DS2422 for a mission is included at the end of this document, preceding the Electrical Characteristics section. The communication between master and DS2422 takes place either at regular speed (default, OD = 0) or at Overdrive Speed (OD = 1). If not explicitly set into the Overdrive Mode the DS2422 assumes regular speed. Internal memory access during a mission has priority over external access through the 1-Wire interface. This affects several of the commands described below. See section *Memory Access Conflicts* for details and remedies.

WRITE SCRATCHPAD COMMAND [0Fh]

After issuing the Write Scratchpad command, the master must first provide the 2-byte target address, followed by the data to be written to the scratchpad. The data is written to the scratchpad starting at the byte offset (T4:T0). The master has to send as many bytes as are needed to reach the Ending Offset of 1Fh. If a data byte is incomplete, its content is ignored and the partial byte flag PF is set.

When executing the Write Scratchpad command the CRC generator inside the DS2422 (see Figure 18) calculates a CRC of the entire data stream, starting at the command code and ending at the last data byte sent by the master. This CRC is generated using the CRC16 polynomial by first clearing the CRC generator and then shifting in the command code (0Fh) of the Write Scratchpad command, the Target Addresses TA1 and TA2 as supplied by the master and all the data bytes. The master may end the Write Scratchpad command at any time. If the ending offset is 11111b, the master may send 16 read-time slots and receives the inverted CRC16 generated by the DS2422.

Note that both register pages are write-protected during a mission. Although the Write Scratchpad command works normally at any time, the subsequent copy scratchpad to a register page will fail during a mission.

READ SCRATCHPAD COMMAND [AAh]

This command is used to verify scratchpad data and target address. After issuing the Read Scratchpad command, the master begins reading. The first 2 bytes will be the target address. The next byte will be the ending offset/data status byte (E/S) followed by the scratchpad data beginning at the byte offset (T4:T0), as shown in Figure 11. The master may continue reading data until the end of the scratchpad after which it will receive an inverted CRC16 of the command code, Target Addresses TA1 and TA2, the E/S byte, and the scratchpad data starting at the target address. After the CRC is read, the bus master will read logical 1s from the DS2422 until a reset pulse is issued.

COPY SCRATCHPAD WITH PASSWORD [99h]

This command is used to copy data from the scratchpad to the writable memory sections. After issuing the Copy Scratchpad command, the master must provide a 3-byte authorization pattern, which can be obtained by reading the scratchpad for verification. This pattern must exactly match the data contained in the three address registers (TA1, TA2, E/S, in that order). Next the master must transmit the 64-bit full-access password. If passwords are enabled and the transmitted password is different from the stored full-access password, the Copy Scratchpad with Password command will fail. The device will stop communicating and will wait for a reset pulse. If the password was correct or if passwords were not enabled, the device will test the 3-byte authorization code. If the authorization code pattern matches, the AA (Authorization Accepted) flag will be set and the copy will begin. A pattern of alternating 1s and 0s will be transmitted after the data has been copied until the master issues a reset pulse. While the copy is in progress any attempt to reset the part will be ignored. Copy typically takes 2 μ s per byte.

The data to be copied is determined by the three address registers. The scratchpad data from the beginning offset through the ending offset will be copied, starting at the target address. Anywhere from 1 to 32 bytes may be copied to memory with this command. The AA flag will remain at logic 1 until it is cleared by the next Write Scratchpad command. With suitable password, the copy scratchpad will always function for the 16 pages of data memory and the 2 pages of calibration memory. While a mission is in progress, write attempts to the register pages will not be successful. The AA bit (Authorization Accepted) remaining at 0 will indicate this.

READ MEMORY WITH PASSWORD AND CRC [69h]

The Read Memory with CRC command is the general function to read from the device. This command generates and transmits a 16-bit CRC following the last data byte of a memory page.

After having sent the command code of the Read Memory with CRC command, the bus master sends a 2-byte address that indicates a starting byte location. Next the master must transmit one of the 64-bit passwords. If passwords are enabled and the transmitted password does not match one of the stored passwords, the Read Memory with Password and CRC command will fail. The device will stop communicating and will wait for a reset pulse. If the password was correct or if passwords were not enabled, the master reads data from the DS2422 beginning from the starting address and continuing until the end of a 32-byte page is reached. At that point the bus master will send 16 additional read data time slots and receive the inverted 16-bit CRC. With subsequent read data time slots the master will receive data starting at the beginning of the next memory page followed again by the CRC for that page. This sequence will continue until the bus master resets the device. When trying to read the passwords or memory areas that are marked as "reserved", the DS2422 will transmit 00h or FFh bytes respectively. The CRC at the end of a 32-byte memory page is based on the data as it was transmitted.

With the initial pass through the Read Memory with CRC flow, the 16-bit CRC value is the result of shifting the command byte into the cleared CRC generator followed by the 2 address bytes and the contents of the data memory. Subsequent passes through the Read Memory with CRC flow will generate a 16-bit CRC that is the result of clearing the CRC generator and then shifting in the contents of the data memory page. After the 16-bit CRC of the last page is read, the bus master will receive logical 1s from the DS2422 until a reset pulse is issued. The Read Memory with CRC command sequence can be ended at any point by issuing a reset pulse.

Figure 12-1. Memory/Control Function Flow Chart

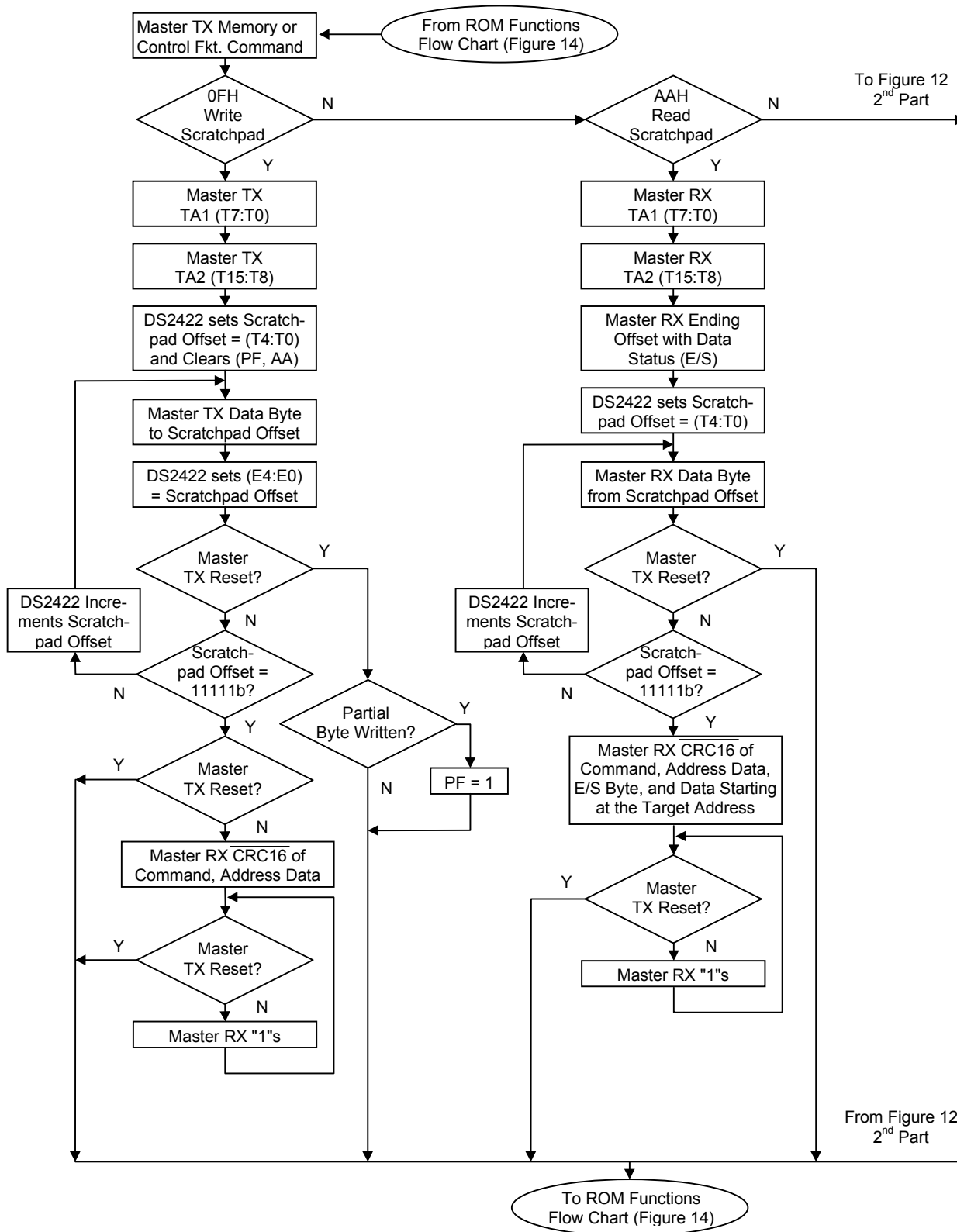

Figure 12-2. Memory/Control Function Flow Chart

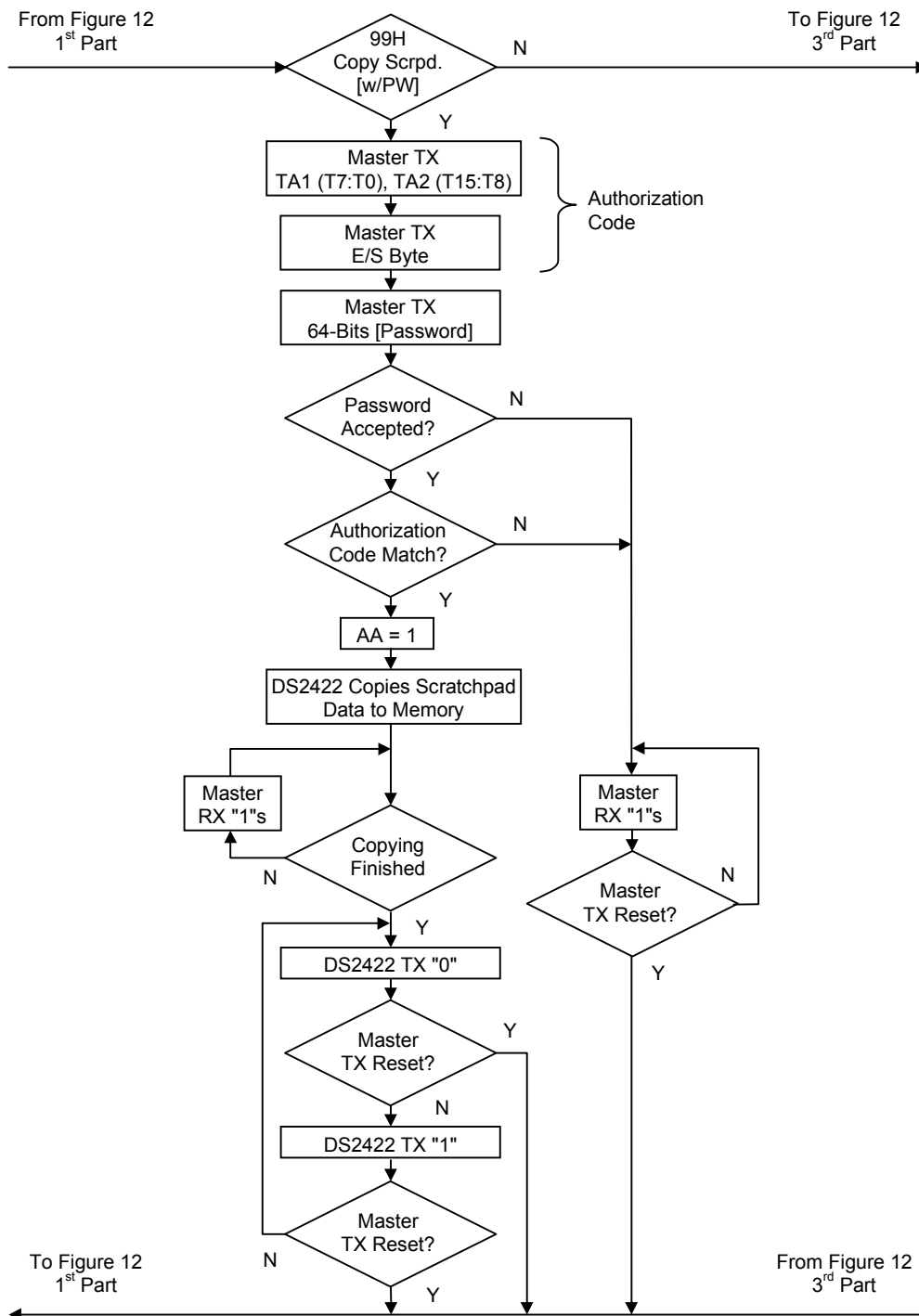

Figure 12-3. Memory/Control Function Flow Chart

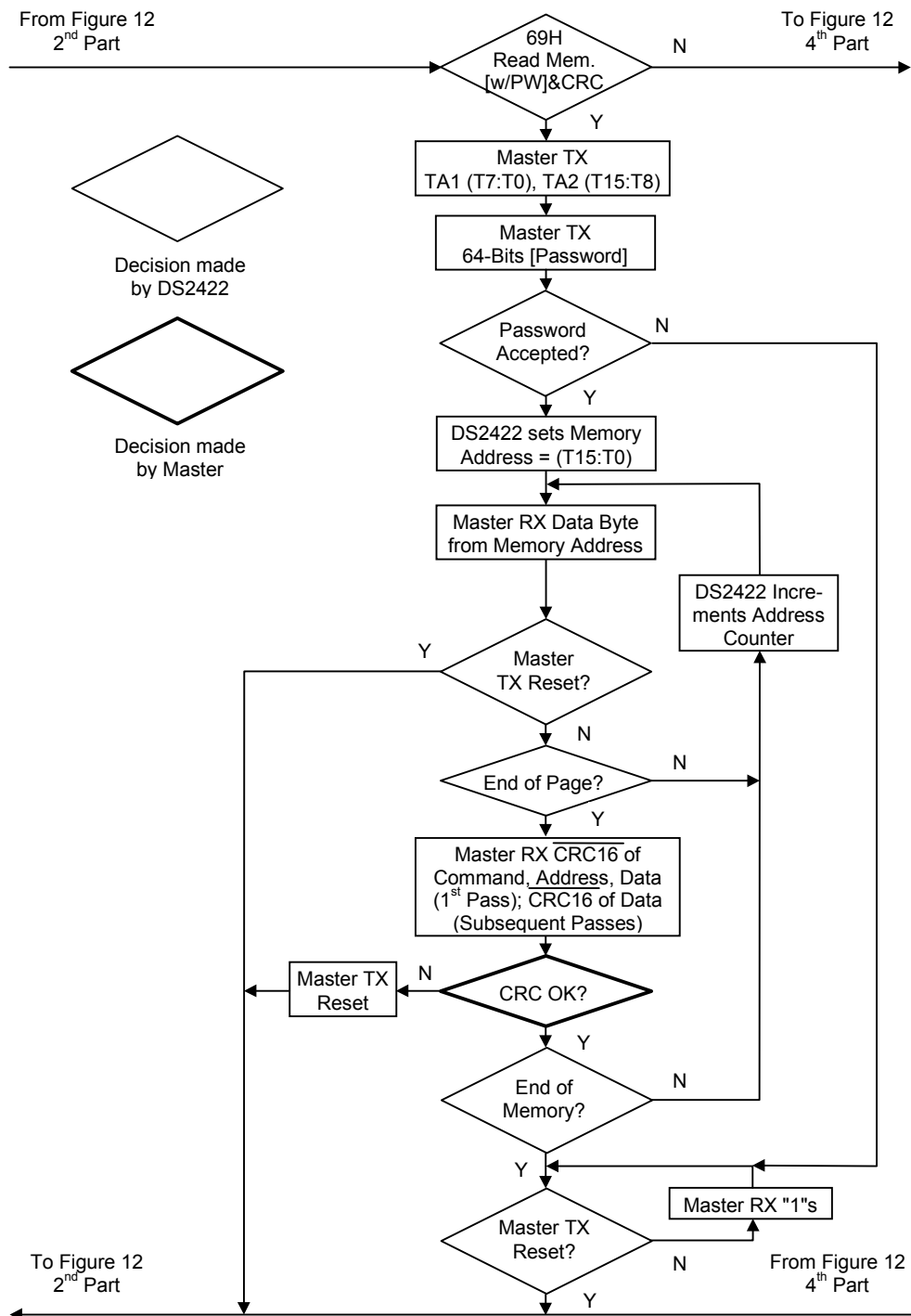

Figure 12-4. Memory/Control Function Flow Chart

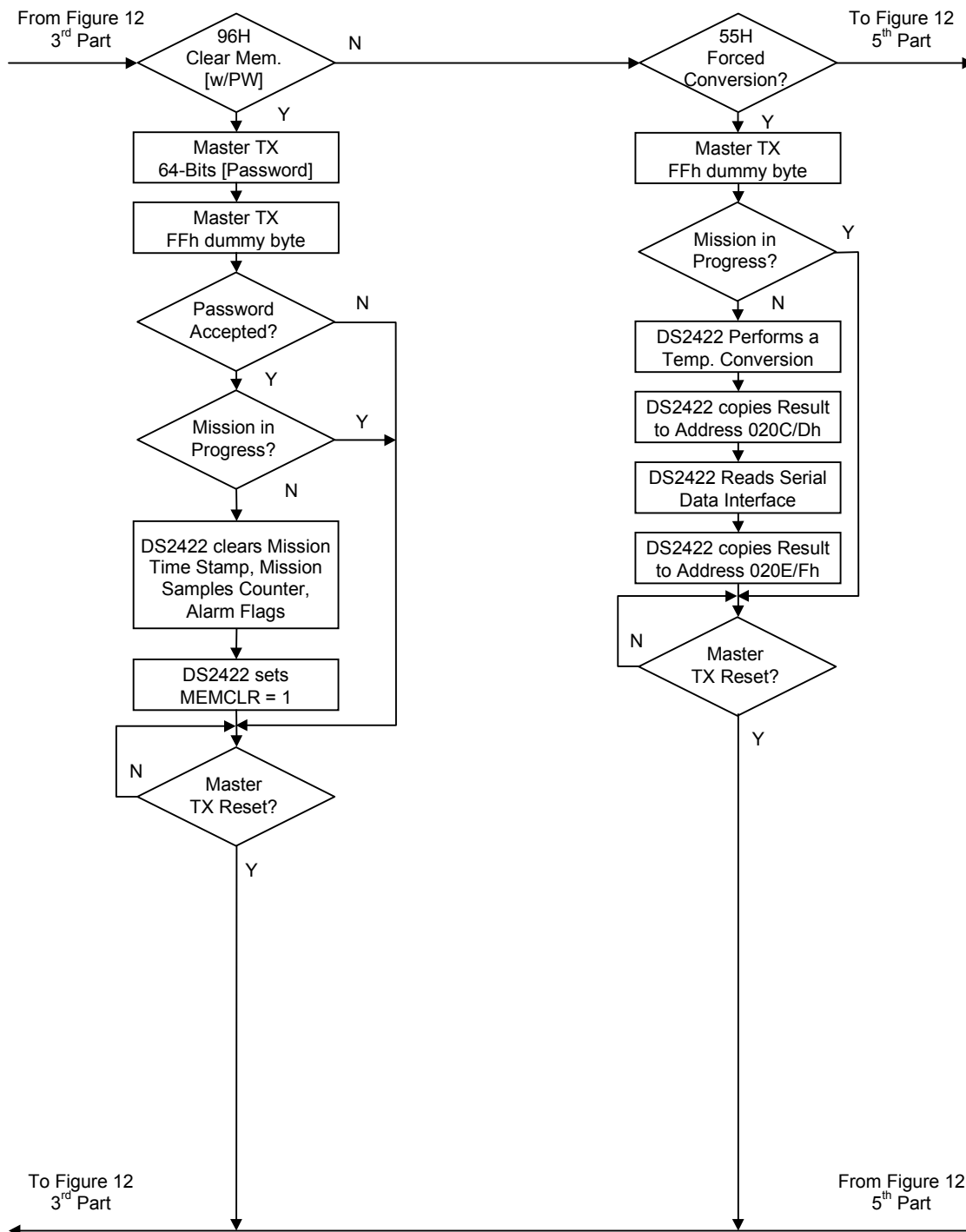
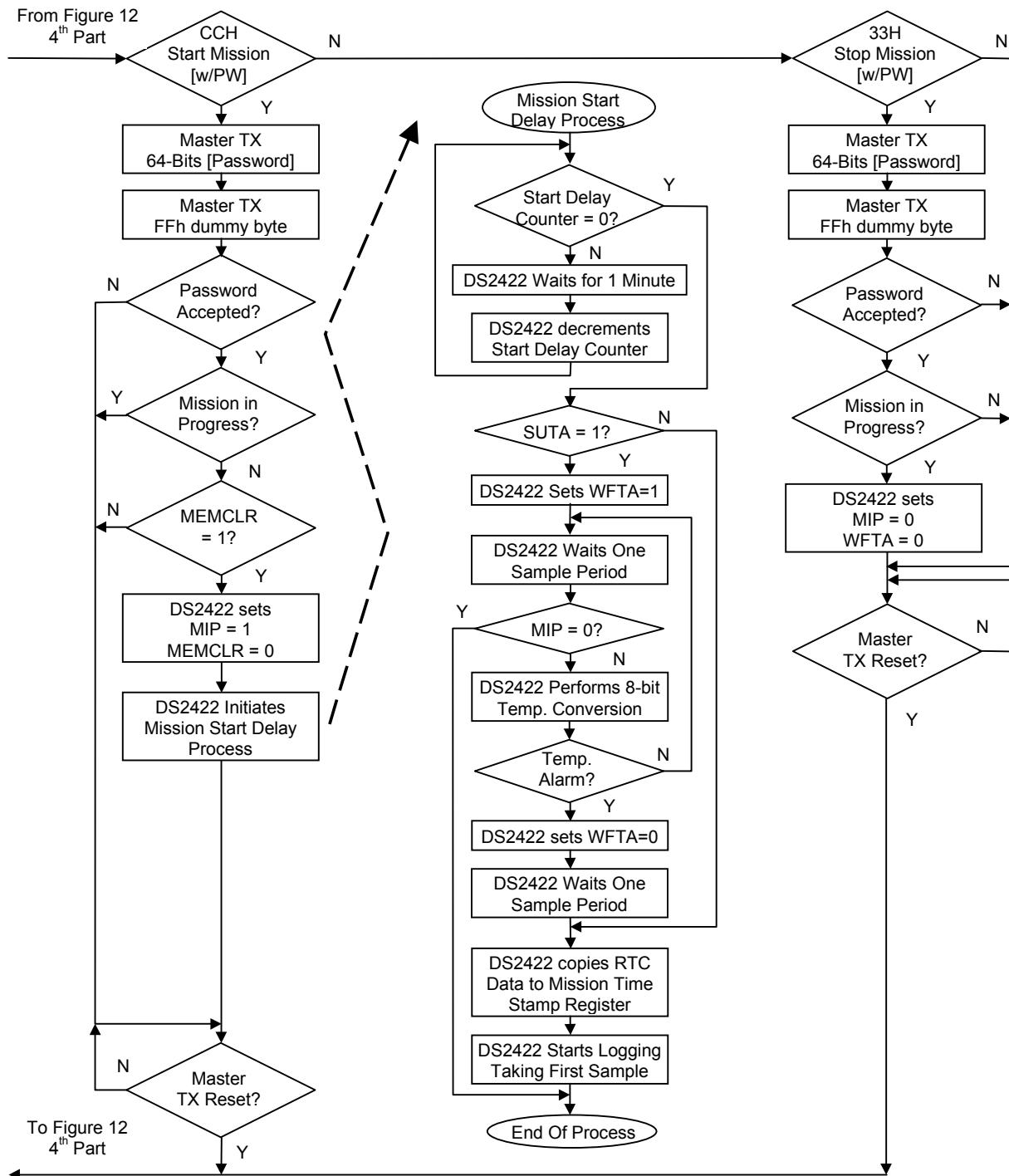

Figure 12-5. Memory/Control Function Flow Chart



CLEAR MEMORY WITH PASSWORD [96h]

The Clear Memory with Password command is used to prepare the device for another mission. This command will only be executed if no mission is in progress. After the command code the master must transmit the 64-bit full-access password followed by a FFh dummy byte. If passwords are enabled and the transmitted password is different from the stored full-access password or a mission is in progress, the Clear Memory with Password command will fail. The device will stop communicating and will wait for a reset pulse. If the password was correct or if passwords were not enabled, the device will clear the Mission Time Stamp, Mission Samples Counter, Sample Rate Register, and all alarm flags of the Alarm Status Register. After these cells are cleared, the MEMCLR bit of the General Status Register will read 1 to indicate the successful execution of the Clear Memory with Password command. Clearing of the datalog memory is not necessary because the Mission Samples Counter indicates how many entries in the datalog memory are valid.

FORCED CONVERSION [55h]

The Forced Conversion command can be used to measure the temperature and read data from the serial data interface without starting a mission. After the command code the master has to send one FFh byte to get the conversion started. The conversion result is found as 16-bit value in the Latest Temperature Conversion Result and Latest Serial Data Reading registers. This command is only executed if no mission is in progress (MIP = 0). It cannot be interrupted and takes maximum 666 ms to complete. During this time memory access through the 1-Wire interface is blocked. The device will behave the same way as during a mission when the sampling interferes with a memory/control function command. See *Memory Access Conflicts* for details.

START MISSION WITH PASSWORD [CCh]

The DS2422 uses a control function command to start a mission. A new mission can only be started if the previous mission has been ended and the memory has been cleared. After the command code, the master must transmit the 64-bit full-access password followed by a FFh dummy byte. If passwords are enabled and the transmitted password is different from the stored full-access password or a mission is in progress, the Start Mission with Password command will fail. The device will stop communicating and will wait for a reset pulse. If the password was correct or if passwords were not enabled, the device will start a mission. If SUTA = 0, the sampling begins as soon as the Mission Start Delay is over. If SUTA = 1, the first sample is written to the data-log memory at the time the temperature alarm occurred. However, the Mission Sample Counter does not increment. One sample period later, the Mission Timestamp register is set and the regular sampling and logging begins. While the device is waiting for a temperature alarm to occur, the WFTA flag in the general status register will read 1. During a mission there is only read access to the Register Pages.

STOP MISSION WITH PASSWORD [33h]

The DS2422 uses a control function command to stop a mission. Only a mission that is in progress can be stopped. After the command code, the master must transmit the 64-bit full-access password followed by a FFh dummy byte. If passwords are enabled and the transmitted password is different from the stored full-access password or a mission is not in progress, the Stop Mission with Password command will fail. The device will stop communicating and will wait for a reset pulse. If the password was correct or if passwords were not enabled, the device will clear the MIP bit in the General Status Register and restore write access to the Register Pages. The WFTA bit is not cleared. See the description of the General Status Register for a method to clear the WFTA bit.

MEMORY ACCESS CONFLICTS

While a mission is in progress or while the device is waiting for a temperature alarm to start a mission, periodically a temperature sample is taken and/or data is read from the serial interface and logged. This "internal activity" has priority over 1-Wire communication. As a consequence, device-specific commands (excluding ROM function commands and 1-Wire reset) will not perform properly when internal and "external" activities interfere with each other. Not affected are the commands Start Mission, Forced Conversion and Clear Memory, because they are not applicable while a mission is in progress or while the device is waiting for a temperature alarm. The table below explains how the remaining five commands are affected by internal activity, how to detect this interference and how to work around it.

COMMAND	INDICATION OF INTERFERENCE	REMEDY
Write Scratchpad	The CRC16 at the end of the command flow reads FFFFh.	Wait 0.5 seconds, 1-Wire reset, address the device, repeat Write Scratchpad with the same data and check the validity of the CRC16 at the end of the command flow. Alternatively, use Read Scratchpad to verify data integrity.
Read Scratchpad	The data read changes to FFh bytes or all bytes received are FFh, including the CRC at the end of the command flow.	Wait 0.5 seconds, 1-Wire reset, address the device, repeat Read Scratchpad and check the validity of the CRC16 at the end of the command flow.
Copy Scratchpad	The device behaves as if Authorization Code or password was not valid or as if the copy function would not end.	Wait 0.5 seconds, 1-Wire reset, address the device, issue Read Scratchpad and check the AA-bit of the E/S byte. If the AA-bit is set, Copy Scratchpad was successful.
Read Memory with CRC	The data read changes to all FFh bytes or all bytes received are FFh, including the CRC at the end of the command flow, despite a valid password.	Wait 0.5 seconds, 1-Wire reset, address the device, repeat Read Memory with CRC and check the validity of the CRC16 at the end of the memory page.
Stop Mission	The general Status register at address 215h reads FFh or the MIP bit is 1 while bits 0, 2, and 5 are 0.	Wait 0.5 seconds, 1-Wire reset, address the device, and repeat Stop Mission. Perform a 1-Wire reset, address the device, read the general Status register at address 215h and check the MIP-bit. If the MIP-bit is 0, Stop Mission was successful.

The interference is more likely to be seen with a high sample rate (1 sample every second) and with high-resolution logging, which can last up to 666ms when both temperature and external data are recorded. With lower sample rates interference may hardly be visible at all. In any case, when writing driver software, it is important to know about the possibility of interference and to take measures to work around it.

1-Wire BUS SYSTEM

The 1-Wire bus is a system, which has a single bus master and one or more slaves. In all instances the DS2422 is a slave device. The bus master is typically a microcontroller. The discussion of this bus system is broken down into three topics: hardware configuration, transaction sequence, and 1-Wire signaling (signal types and timing). The 1-Wire protocol defines bus transactions in terms of the bus state during specific time slots that are initiated on the falling edge of sync pulses from the bus master. For a more detailed protocol description, refer to Chapter 4 of the *Book of DS19xx iButton Standards*.

HARDWARE CONFIGURATION

The 1-Wire bus has only a single line by definition; it is important that each device on the bus be able to drive it at the appropriate time. To facilitate this, each device attached to the 1-Wire bus must have open drain or tri-state outputs. The 1-Wire port of the DS2422 is open-drain with an internal circuit equivalent to that shown in Figure 13.

A multidrop bus consists of a 1-Wire bus with multiple slaves attached. At standard speed the 1-Wire bus has a maximum data rate of 16.3kbps. The speed can be boosted to 142kbps by activating the Overdrive mode. The DS2422 is not guaranteed to be fully compliant to the iButton Standard. Its maximum data rate in standard speed mode is 15.4kbps and 125kbps in Overdrive. The value of the pullup resistor primarily depends on the network size and load conditions. The DS2422 requires a pullup resistor of maximum 2.2k Ω at any speed.

The idle state for the 1-Wire bus is high. If for any reason a transaction needs to be suspended, the bus MUST be left in the idle state if the transaction is to resume. If this does not occur and the bus is left low for more than 16 μ s (Overdrive speed) or more than 120 μ s (standard speed), one or more devices on the bus may be reset. Note that the DS2422 does not quite meet the full 16 μ s maximum low time of the normal 1-Wire bus Overdrive timing. With the DS2422 the bus must be left low for no longer than 12 μ s at Overdrive to ensure that no DS2422 on the 1-Wire

bus performs a reset. The DS2422 will communicate properly when used in conjunction with a DS2480B or DS2490 1-Wire driver and adapters that are based on these driver chips.

Figure 13. Hardware Configuration

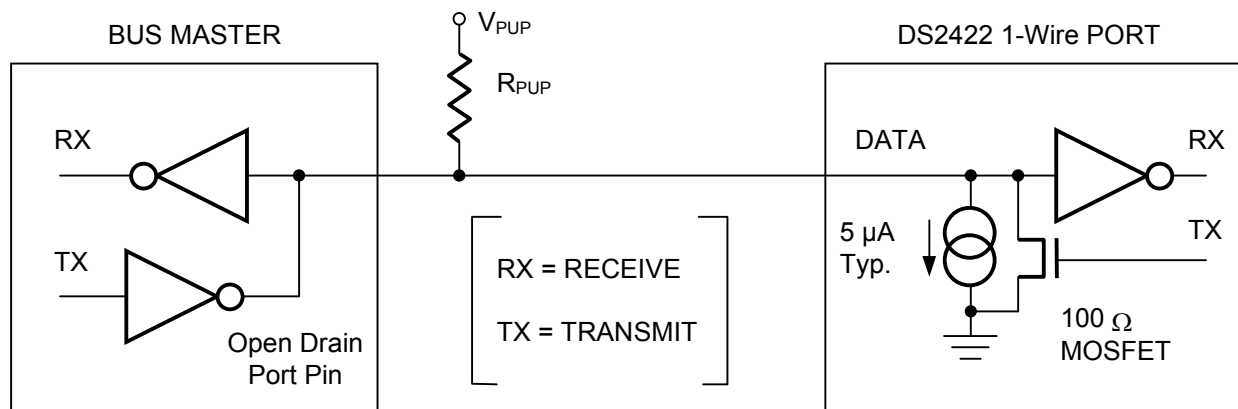

TRANSACTION SEQUENCE

The protocol for accessing the DS2422 through the 1-Wire port is as follows:

- Initialization
- ROM Function Command
- Memory/Control Function Command
- Transaction/Data

INITIALIZATION

All transactions on the 1-Wire bus begin with an initialization sequence. The initialization sequence consists of a reset pulse transmitted by the bus master followed by presence pulse(s) transmitted by the slave(s). The presence pulse lets the bus master know that the DS2422 is on the bus and is ready to operate. For more details, see the *1-Wire Signaling* section.

1-Wire ROM FUNCTION COMMANDS

Once the bus master has detected a presence, it can issue one of the eight ROM function commands that the DS2422 supports. All ROM function commands are 8 bits long. A list of these commands follows (refer to flowchart in Figure 14).

READ ROM [33h]

This command allows the bus master to read the DS2422's 8-bit family code, unique 48-bit serial number, and 8-bit CRC. This command can only be used if there is a single slave on the bus. If more than one slave is present on the bus, a data collision will occur when all slaves try to transmit at the same time (open drain will produce a wired-AND result). The resultant family code and 48-bit serial number will result in a mismatch of the CRC.

MATCH ROM [55h]

The Match ROM command, followed by a 64-bit ROM sequence, allows the bus master to address a specific DS2422 on a multidrop bus. Only the DS2422 that exactly matches the 64-bit ROM sequence will respond to the following memory function command. All other slaves will wait for a reset pulse. This command can be used with a single or multiple devices on the bus.

SEARCH ROM [F0h]

When a system is initially brought up, the bus master might not know the number of devices on the 1-Wire bus or their registration numbers. By taking advantage of the wired-AND property of the bus, the master can use a process of elimination to identify the registration numbers of all slave devices. For each bit of the registration number, starting with the least significant bit, the bus master issues a triplet of time slots. On the first slot, each slave device participating in the search outputs the true value of its registration number bit. On the second slot, each slave device participating in the search outputs the complemented value of its registration number bit. On the third slot, the master writes the true value of the bit to be selected. All slave devices that do not match the bit written by the master stop participating in the search. If both of the read bits are zero, the master knows that slave devices exist with both states of the bit. By choosing which state to write, the bus master branches in the romcode tree. After one complete pass, the bus master knows the registration number of a single device. Additional passes identify the registration numbers of the remaining devices. Refer to *Application Note 187: 1-Wire Search Algorithm* for a detailed discussion, including an example.

CONDITIONAL SEARCH [ECh]

The Conditional Search ROM command operates similarly to the Search ROM command except that only those devices, which fulfill certain conditions, will participate in the search. This function provides an efficient means for the bus master to identify devices on a multidrop system that have to signal an important event. After each pass of the conditional search that successfully determined the 64-bit ROM code for a specific device on the multidrop bus, that particular device can be individually accessed as if a Match ROM had been issued, since all other devices will have dropped out of the search process and will be waiting for a reset pulse.

The DS2422 will respond to the conditional search if one of the five alarm flags of the Alarm Status Register (address 0214h) reads 1. The data and temperature alarm will only occur if enabled (see Temperature Sensor Alarm and Serial Input Alarm). The BOR alarm is always enabled. The first alarm that occurs will make the device respond to the Conditional Search command.

SKIP ROM [CCh]

This command can save time in a single-drop bus system by allowing the bus master to access the memory functions without providing the 64-bit ROM code. If more than one slave is present on the bus and, for example, a Read command is issued following the Skip ROM command, data collision will occur on the bus as multiple slaves transmit simultaneously (open drain pulldowns will produce a wired-AND result).

RESUME COMMAND [A5h]

The DS2422 needs to be accessed several times before a mission will start. In a multidrop environment this means that the 64-bit ROM code after a Match ROM command has to be repeated for every access. To maximize the data throughput in a multidrop environment, the Resume function was implemented. This function checks the status of the RC bit and, if it is set, directly transfers control to the Memory/Control functions, similar to a Skip ROM

command. The only way to set the RC bit is through successfully executing the Match ROM, Search ROM or Overdrive Match ROM command. Once the RC bit is set, the device can repeatedly be accessed through the Resume Command function. Accessing another device on the bus will clear the RC bit, preventing two or more devices from simultaneously responding to the Resume Command function.

OVERDRIVE SKIP ROM [3Ch]

On a single-drop bus this command can save time by allowing the bus master to access the memory/control functions without providing the 64-bit ROM code. Unlike the normal Skip ROM command, the Overdrive Skip ROM sets the DS2422 in the Overdrive mode (OD = 1). All communication following this command has to occur at Overdrive speed until a reset pulse of minimum 690 μ s duration resets all devices on the bus to standard speed (OD = 0).

When issued on a multidrop bus this command will set all Overdrive-supporting devices into Overdrive mode. To subsequently address a specific Overdrive-supporting device, a reset pulse at Overdrive speed has to be issued followed by a Match ROM or Search ROM command sequence. This will speed up the time for the search process. If more than one slave supporting Overdrive is present on the bus and the Overdrive Skip ROM command is followed by a Read command, data collision will occur on the bus as multiple slaves transmit simultaneously (open-drain pulldowns will produce a wired-AND result).

OVERDRIVE MATCH ROM [69h]

The Overdrive Match ROM command followed by a 64-bit ROM sequence transmitted at Overdrive Speed allows the bus master to address a specific DS2422 on a multidrop bus and to simultaneously set it in Overdrive mode. Only the DS2422 that exactly matches the 64-bit ROM sequence will respond to the subsequent memory/control function command. Slaves already in Overdrive mode from a previous Overdrive Skip or successful Overdrive Match command will remain in Overdrive mode. All overdrive-capable slaves will return to standard speed at the next Reset Pulse of minimum 690 μ s duration. The Overdrive Match ROM command can be used with a single or multiple devices on the bus.

Figure 14-1. ROM Functions Flow Chart

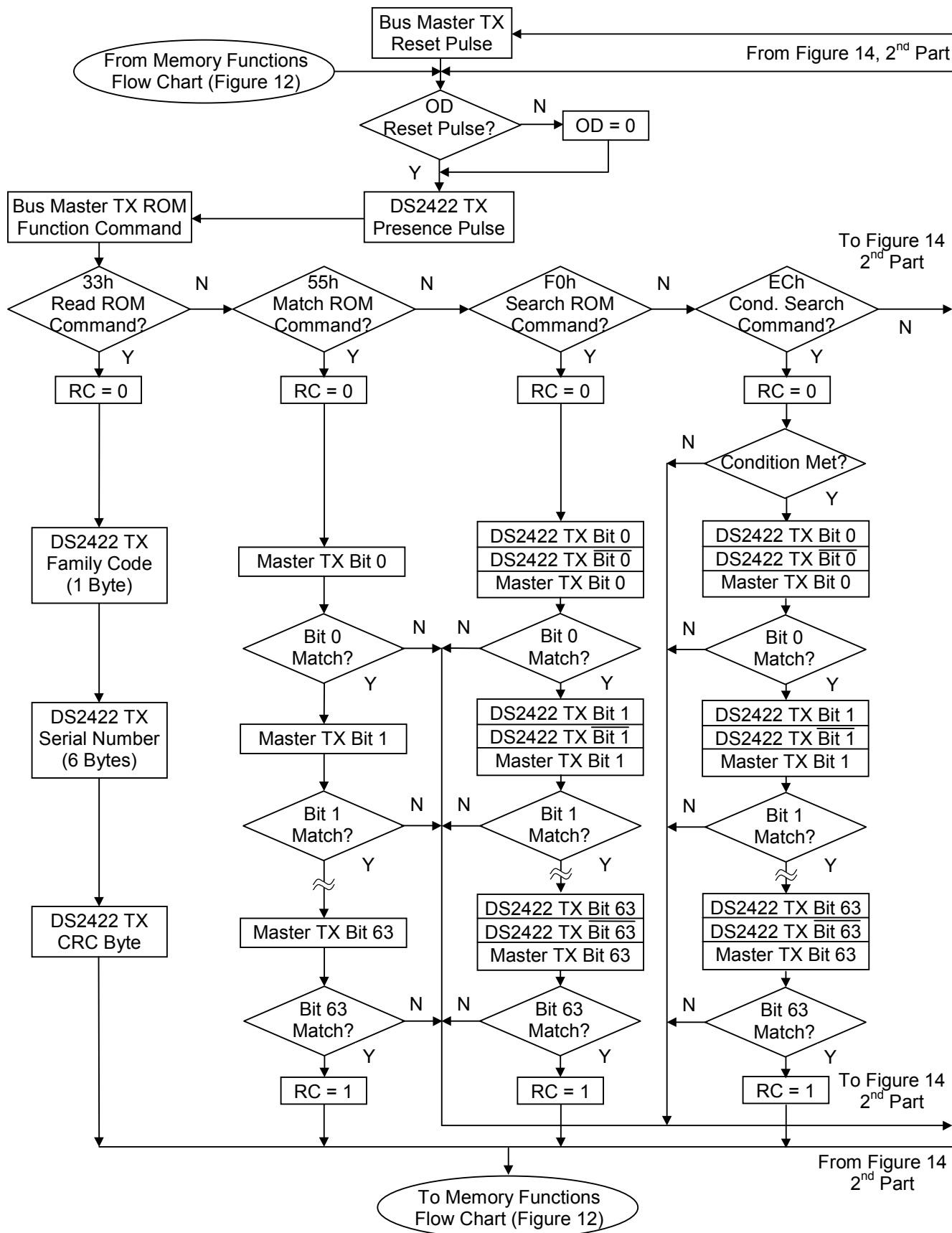
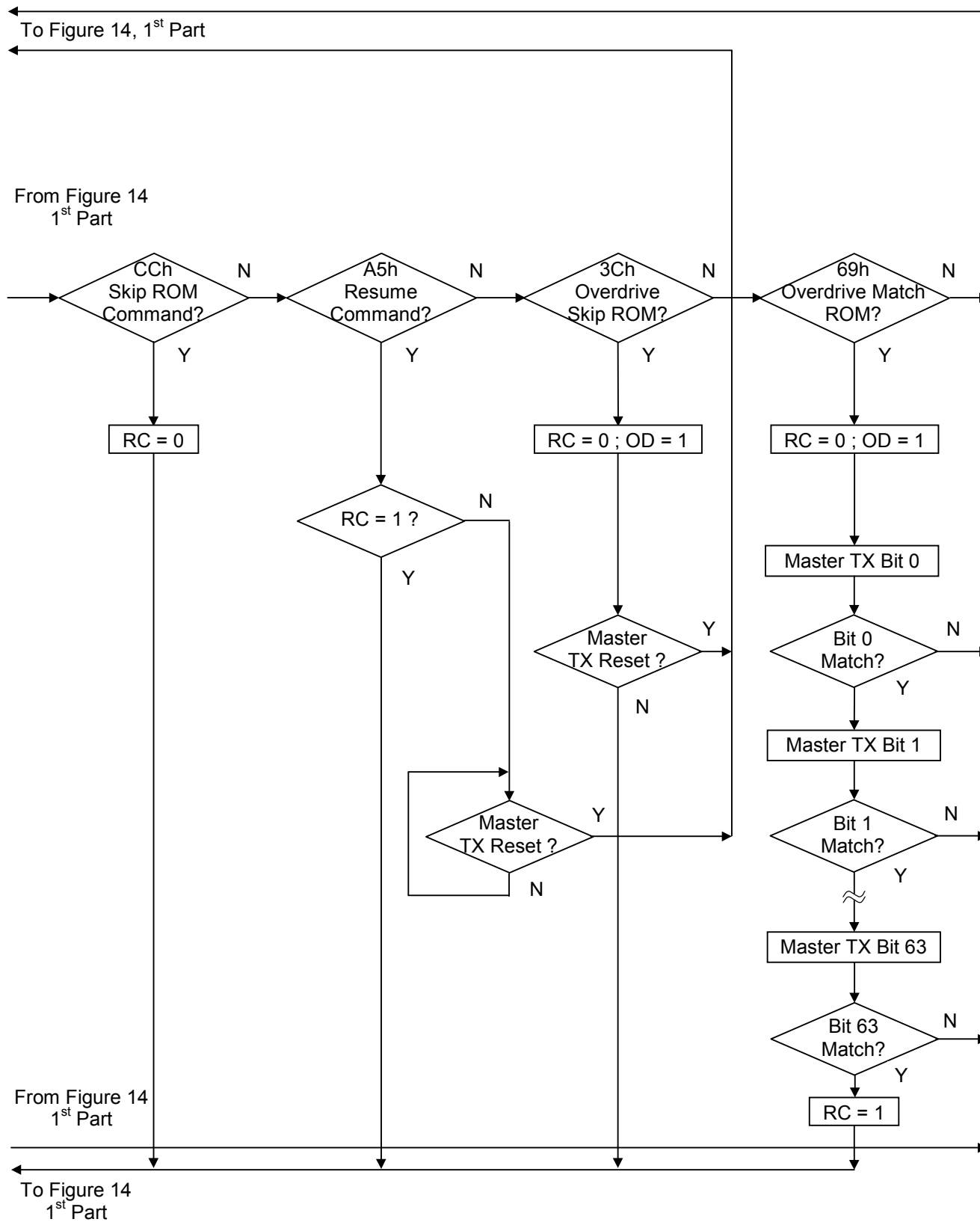

Figure 14-2. ROM Functions Flow Chart



1-Wire SIGNALING

The DS2422 requires strict protocols to ensure data integrity. The protocol consists of four types of signaling on one line: Reset Sequence with Reset Pulse and Presence Pulse, Write-Zero, Write-One and Read-Data. Except for the presence pulse the bus master initiates all these signals. The DS2422 can communicate at two different speeds, standard speed, and Overdrive Speed. If not explicitly set into the Overdrive mode, the DS2422 will communicate at standard speed. While in Overdrive Mode the fast timing applies to all waveforms.

To get from idle to active, the voltage on the 1-Wire line needs to fall from V_{PUP} below the threshold V_{TL} . To get from active to idle, the voltage needs to rise from V_{ILMAX} past the threshold V_{TH} . The time it takes for the voltage to make this rise is seen in Figure 15 as ' ϵ ' and its duration depends on the pull-up resistor (R_{PUP}) used and the capacitance of the 1-Wire network attached. The voltage V_{ILMAX} is relevant for the DS2422 when determining a logical level, not triggering any events.

The initialization sequence required to begin any communication with the DS2422 is shown in Figure 15. A Reset Pulse followed by a Presence Pulse indicates the DS2422 is ready to receive data, given the correct ROM and memory function command. If the bus master uses slew-rate control on the falling edge, it must pull down the line for $t_{RSTL} + t_F$ to compensate for the edge. A t_{RSTL} duration of 690 μ s or longer will exit the Overdrive Mode returning the device to standard speed. If the DS2422 is in Overdrive Mode and t_{RSTL} is no longer than 80 μ s the device will remain in Overdrive Mode.

Figure 15. Initialization Procedure “Reset and Presence Pulses”

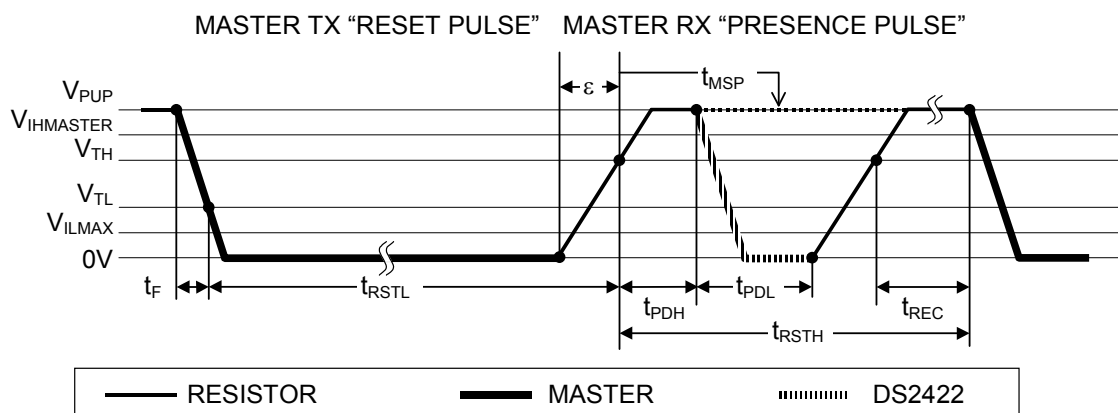

After the bus master has released the line it goes into receive mode (RX). Now the 1-Wire bus is pulled to V_{PUP} through the pullup resistor or, in case of a DS2480B driver, by active circuitry. When the threshold V_{TH} is crossed, the DS2422 waits for t_{PDH} and then transmits a Presence Pulse by pulling the line low for t_{PDL} . To detect a presence pulse, the master must test the logical state of the 1-Wire line at t_{MSP} .

The t_{RSTH} window must be at least the sum of t_{PDHMAX} , t_{PDLMAX} , and t_{RECMIN} . Immediately after t_{RSTH} is expired, the DS2422 is ready for data communication. In a mixed population network t_{RSTH} should be extended to minimum 480 μ s at standard speed and 48 μ s at Overdrive speed to accommodate other 1-Wire devices.

Read/Write Time Slots

Data communication with the DS2422 takes place in time slots, which carry a single bit each. Write time slots transport data from bus master to slave. Read time slots transfer data from slave to master. The definitions of the write and read time slots are illustrated in Figure 16.

All communication begins with the master pulling the data line low. As the voltage on the 1-Wire line falls below the threshold V_{TL} , the DS2422 starts its internal timing generator that determines when the data line will be sampled during a write time slot and how long data will be valid during a read time slot.

Master-to-Slave

For a **write-one** time slot, the voltage on the data line must have crossed the V_{TH} threshold before the write-one low time t_{W1LMAX} is expired. For a **write-zero** time slot, the voltage on the data line must stay below the V_{TH} threshold until the write-zero low time t_{W0LMIN} is expired. For most reliable communication the voltage on the data line should not exceed V_{ILMAX} during the entire t_{W0L} or t_{W1L} window. After the V_{TH} threshold has been crossed, the DS2422 needs a recovery time t_{REC} before it is ready for the next time slot.

Figure 16. Read/Write Timing Diagram

Write-One Time Slot

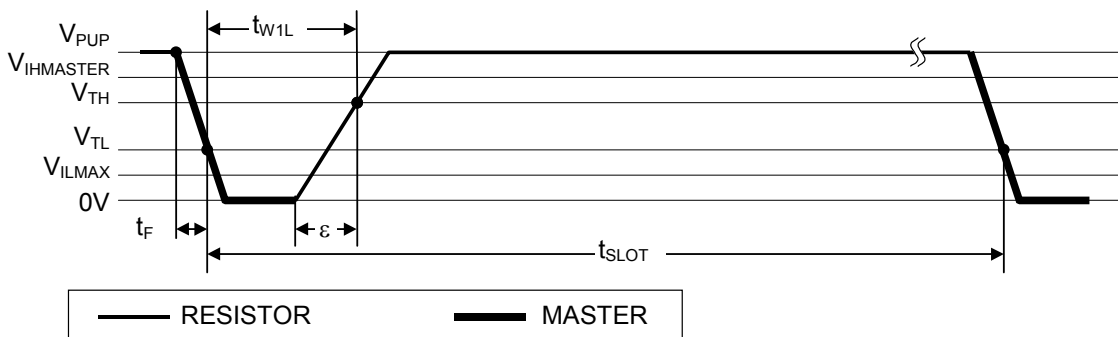

Write-Zero Time Slot

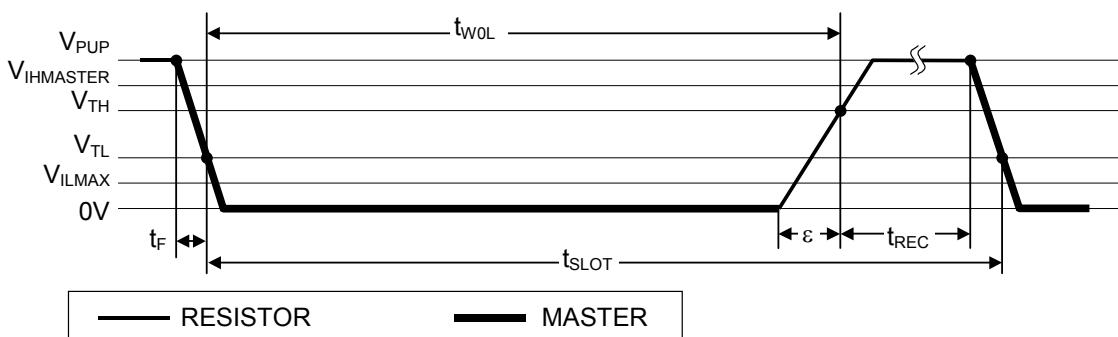

Read-Data Time Slot

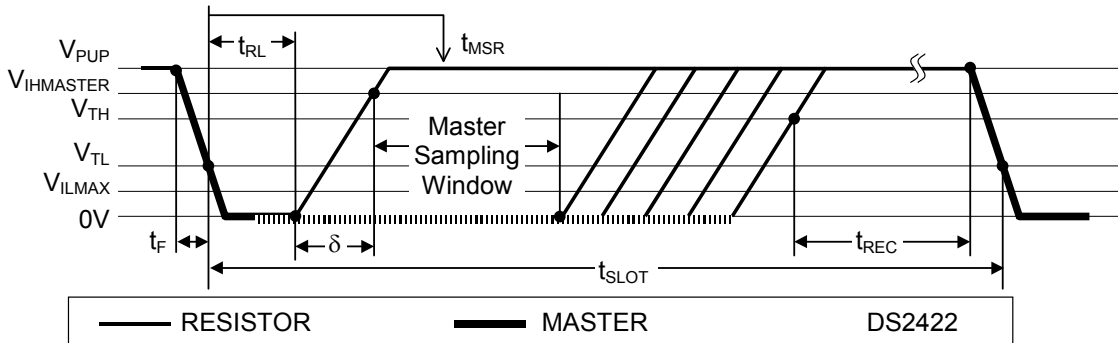

Slave-to-Master

A **read-data** time slot begins like a write-one time slot. The voltage on the data line must remain below V_{TL} until the read low time t_{RL} is expired. During the t_{RL} window, when responding with a 0, the DS2422 will start pulling the data line low; its internal timing generator determines when this pulldown ends and the voltage starts rising again. When responding with a 1, the DS2422 will not hold the data line low at all, and the voltage starts rising as soon as t_{RL} is over.

The sum of $t_{RL} + \delta$ (rise time) on one side and the internal timing generator of the DS2422 on the other side define the master sampling window (t_{MSRMIN} to t_{MSRMAX}) in which the master must perform a read from the data line. For most reliable communication, t_{RL} should be as short as permissible and the master should read close to but no later than t_{MSRMAX} . After reading from the data line, the master must wait until t_{SLOT} is expired. This guarantees sufficient recovery time t_{REC} for the DS2422 to get ready for the next time slot.

IMPROVED NETWORK BEHAVIOR

In a 1-Wire environment line termination is possible only during transients controlled by the bus master (1-Wire driver). 1-Wire networks, therefore, are susceptible to noise of various origins. Depending on the physical size and topology of the network, reflections from end points and branch points can add up or cancel each other to some extent. Such reflections are visible as glitches or ringing on the 1-Wire communication line. Noise coupled onto the 1-Wire line from external sources can also result in signal glitching. A glitch during the rising edge of a time slot can cause a slave device to lose synchronization with the master and, as a consequence, result in a search ROM command coming to a dead end or cause a device-specific function command to abort. For better performance in network applications, the DS2422 uses a new 1-Wire front end, which makes it less sensitive to noise and also reduces the magnitude of noise injected by the slave device itself.

The 1-Wire front end of the DS2422 differs from traditional slave devices in four characteristics.

- 1) The falling edge of the presence pulse has a controlled slew rate. This provides a better match to the line impedance than a digitally switched transistor, converting the high frequency ringing known from traditional devices into a smoother low-bandwidth transition. The slew rate control is specified by the parameter t_{FPD} , which has different values for standard and Overdrive speed.
- 2) There is additional low-pass filtering in the circuit that detects the falling edge at the beginning of a time slot. This reduces the sensitivity to high-frequency noise. This additional filtering does not apply at Overdrive speed.
- 3) There is a hysteresis at the low-to-high switching threshold V_{TH} . If a negative glitch crosses V_{TH} but doesn't go below $V_{TH} - V_{HY}$, it will not be recognized (Figure 17, Case A). The hysteresis is effective at any 1-Wire speed.
- 4) There is a time window specified by the rising edge hold-off time t_{REH} during which glitches will be ignored, even if they extend below $V_{TH} - V_{HY}$ threshold (Figure 17, Case B, $t_{GL} < t_{REH}$). Deep voltage droops or glitches that appear late after crossing the V_{TH} threshold and extend beyond the t_{REH} window cannot be filtered out and will be taken as beginning of a new time slot (Figure 17, Case C, $t_{GL} \geq t_{REH}$).

Only devices which have the parameters t_{FPD} , V_{HY} and t_{REH} specified in their electrical characteristics use the improved 1-Wire front end.

Figure 17. Noise Suppression Scheme

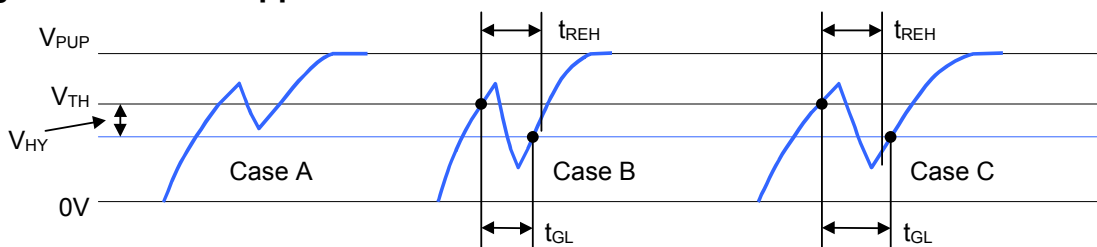

CRC GENERATION

With the DS2422 there are two different types of CRCs (Cyclic Redundancy Checks). One CRC is an 8-bit type and is stored in the most significant byte of the 64-bit ROM. The bus master can compute a CRC value from the first 56 bits of the 64-bit ROM and compare it to the value stored within the DS2422 to determine if the ROM data has been received error-free. The equivalent polynomial function of this CRC is: $X^8 + X^5 + X^4 + 1$. This 8-bit CRC is received in the true (non-inverted) form. It is computed at the factory and lasered into the ROM.

The other CRC is a 16-bit type, generated according to the standardized CRC16-polynomial function $x^{16} + x^{15} + x^2 + 1$. This CRC is used for error detection when reading register pages or the datalog memory using the Read Memory with CRC command and for fast verification of a data transfer when writing to or reading from the scratchpad. In contrast to the 8-bit CRC, the 16-bit CRC is always communicated in the inverted form. A CRC-generator inside the DS2422 chip (Figure 18) will calculate a new 16-bit CRC as shown in the command flow chart of Figure 12. The bus master compares the CRC value read from the device to the one it calculates from the data

and decides whether to continue with an operation or to reread the portion of the data with the CRC error. With the initial pass through the Read Memory with CRC flow chart, the 16-bit CRC value is the result of shifting the command byte into the cleared CRC generator, followed by the 2 address bytes and the data bytes. The password is excluded from the CRC calculation. Subsequent passes through the Read Memory with CRC flow chart will generate a 16-bit CRC that is the result of clearing the CRC generator and then shifting in the data bytes.

With the Write Scratchpad command the CRC is generated by first clearing the CRC generator and then shifting in the command code, the Target Addresses TA1 and TA2 and all the data bytes. The DS2422 will transmit this CRC only if the data bytes written to the scratchpad include scratchpad ending offset 11111b. The data may start at any location within the scratchpad.

With the Read Scratchpad command the CRC is generated by first clearing the CRC generator and then shifting in the command code, the Target Addresses TA1 and TA2, the E/S byte, and the scratchpad data starting at the target address. The DS2422 will transmit this CRC only if the reading continues through the end of the scratchpad, regardless of the actual ending offset. For more information on generating CRC values see *Application Note 27*.

Figure 18. CRC-16 Hardware Description and Polynomial

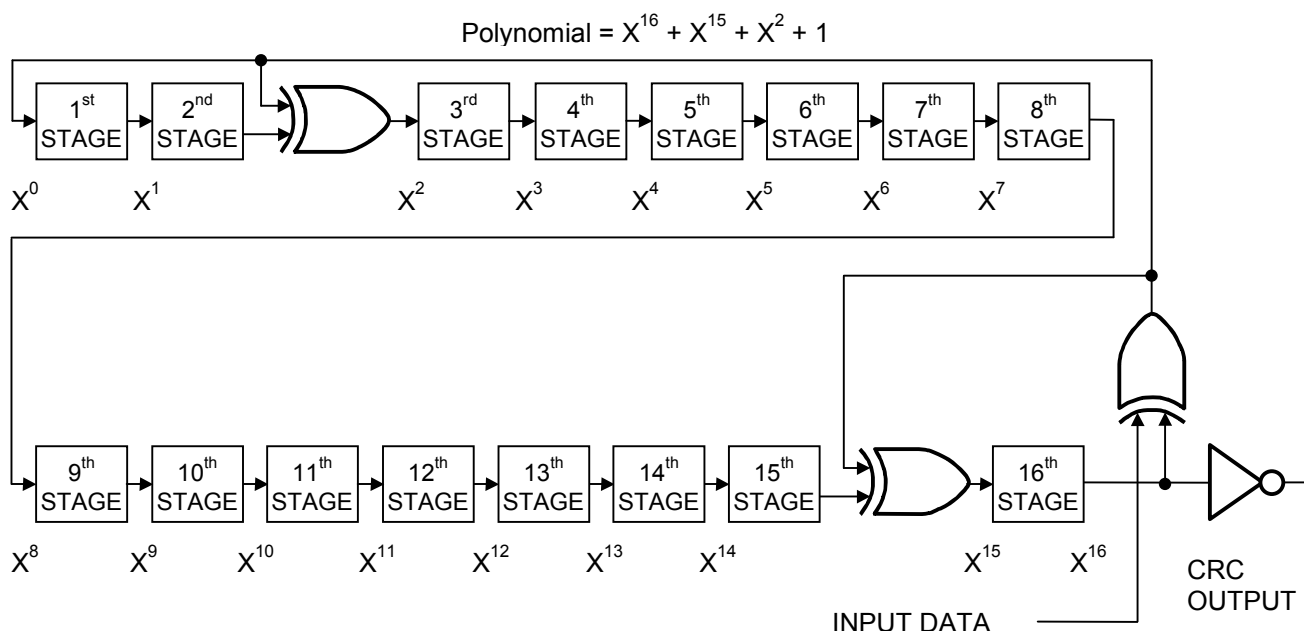
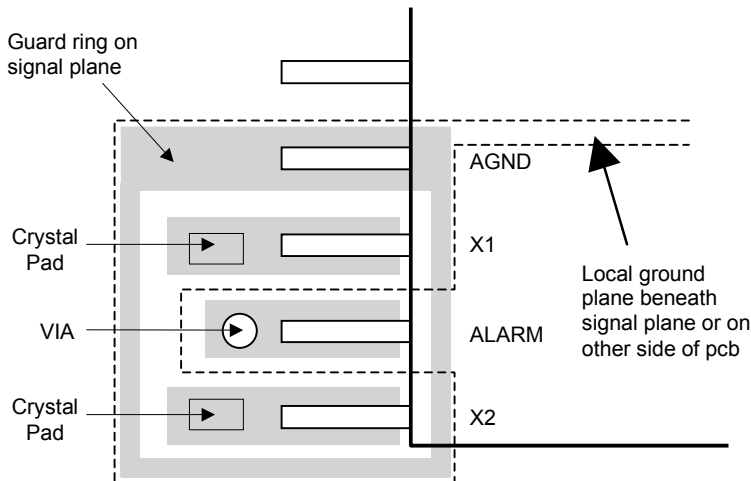

Figure 19. Crystal Placement on PCB



COMMAND-SPECIFIC 1-Wire COMMUNICATION PROTOCOL—LEGEND

SYMBOL	DESCRIPTION
RST	1-Wire Reset Pulse generated by master
PD	1-Wire Presence Pulse generated by slave
Select	Command and data to satisfy the ROM function protocol
WS	Command "Write Scratchpad"
RS	Command "Read Scratchpad"
CPS	Command "Copy Scratchpad with Password"
RMC	Command "Read Memory with Password & CRC"
CM	Command "Clear Memory with Password "
FC	Command "Forced Conversion"
SM	Command "Start Mission with Password"
STP	Command "Stop Mission with Password"
TA	Target Address TA1, TA2
TA-E/S	Target Address TA1, TA2 with E/S byte
<data to EOS>	Transfer of as many data bytes as are needed to reach the scratchpad offset 1Fh
<data to EOP>	Transfer of as many data bytes as are needed to reach the end of a memory page
<data to EOM>	Transfer of as many data bytes as are needed to reach the end of the datalog memory
<PW/dummy>	Transfer of 8 bytes that either represent a valid password or acceptable dummy data
<32 bytes>	Transfer of 32 bytes
<data>	Transfer of an undetermined amount of data
FFh	Transmission of one byte FFh
CRC16\	Transfer of an inverted CRC16
FF loop	Indefinite loop where the master reads FF bytes
AA loop	Indefinite loop where the master reads AA bytes

COMMAND-SPECIFIC 1-Wire COMMUNICATION PROTOCOL—COLOR CODES

Master to slave	Slave to master
-----------------	-----------------

WRITE SCRATCHPAD, REACHING THE END OF THE SCRATCHPAD (CANNOT FAIL)

RST	PD	Select	WS	TA	<data to EOS>	CRC16\	FF loop
-----	----	--------	----	----	---------------	--------	---------

READ SCRATCHPAD (CANNOT FAIL)

RST	PD	Select	RS	TA-E/S	<data to EOS>	CRC16\	FF loop
-----	----	--------	----	--------	---------------	--------	---------

COPY SCRATCHPAD WITH PASSWORD (SUCCESS)

RST	PD	Select	CPS	TA-E/S	<PW/dummy>	AA loop
-----	----	--------	-----	--------	------------	---------

COPY SCRATCHPAD WITH PASSWORD (INVALID TA-E/S OR PASSWORD)

RST	PD	Select	CPS	TA-E/S	<PW/dummy>	FF loop
-----	----	--------	-----	--------	------------	---------

READ MEMORY WITH PASSWORD & CRC (SUCCESS)

RST	PD	Select	RMC	TA	<PW/dummy>	<data to EOP>	CRC16\
-----	----	--------	-----	----	------------	---------------	--------

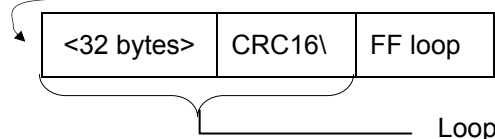
**READ MEMORY WITH PASSWORD & CRC (INVALID PASSWORD OR ADDRESS)**

RST	PD	Select	RMC	TA	<PW/dummy>	FF loop
-----	----	--------	-----	----	------------	---------

CLEAR MEMORY WITH PASSWORD

RST	PD	Select	CM	<PW/dummy>	FFh	FF loop
-----	----	--------	----	------------	-----	---------

To verify success, read the General Status Register at address 0215h. If MEMCLR is 1, the command was executed successfully.

FORCED CONVERSION

RST	PD	Select	FC	FFh	FF loop
-----	----	--------	----	-----	---------

To read the result and to verify success, read the addresses 020Ch to 020Fh (results) and the Device Samples Counter at address 0223h to 0225h. If the count has incremented, the command was executed successfully.

START MISSION WITH PASSWORD

RST	PD	Select	SM	<PW/dummy>	FFh	FF loop
-----	----	--------	----	------------	-----	---------

To verify success, read the General Status Register at address 0215h. If MIP is 1 and MEMCLR is 0, the command was executed successfully.

STOP MISSION WITH PASSWORD

RST	PD	Select	STP	<PW/dummy>	FFh	FF loop
-----	----	--------	-----	------------	-----	---------

To verify success, read the General Status Register at address 0215h. If MIP is 0, the command was executed successfully.

MISSION EXAMPLE: PREPARE AND START A NEW MISSION

Assumption: The previous mission has been ended by using the Stop Mission command. Passwords are not enabled.

Starting a mission with the DS2422 requires three steps:

- Step 1: clear the data of the previous mission
- Step 2: write the setup data to register page 1
- Step 3: start the mission

STEP 1

Clear the previous mission.

With only a single DS2422 connected to the bus master, the communication of step 1 looks like this:

MASTER MODE	DATA (LSB FIRST)	COMMENTS
TX	(Reset)	Reset pulse
RX	(Presence)	Presence pulse
TX	CCh	Issue "skip ROM" command
TX	96h	Issue "clear memory" command
TX	<8 FFh bytes>	Send dummy password
TX	FFh	Send dummy byte
TX	(Reset)	Reset pulse
RX	(Presence)	Presence pulse

STEP 2

During the setup, the device needs to learn the following information:

- Time and Date
- Sample Rate
- Alarm Thresholds
- Alarm Controls (Response to Conditional Search)
- General Mission Parameters (e. g., channels to log and logging format, rollover, start mode)
- Mission Start Delay

The following data will setup the DS2422 for a mission that logs temperature using 8-bit format. Such a mission could last up to 56 days until the 8192-byte datalog memory is full.

ADDRESS	DATA	EXAMPLE VALUES	FUNCTION
0200h	00h	15:30:00 hours	Time
0201h	30h		
0202h	15h		
0203h	01h	1 st of April in 2002	Date
0204h	04h		
0205h	02h		
0206h	0Ah	Every 10 minutes (EHSS = 0)	Sample rate
0207h	00h		
0208h	52h	0°C low	Temperature Alarm Threshold
0209h	66h	10°C high	
020Ah	00h	(Don't care)	External Data Alarm Threshold
020Bh	FFh		
020Ch	FFh	(Don't care)	Clock through read-only registers
020Dh	FFh		
020Eh	FFh		
020Fh	FFh		
0210h	02h	Enable high alarm	Temp. Alarm Control
0211h	FCh	Disabled	Data Alarm Control
0212h	01h	On (enabled), EHSS = 0 (low sample rate)	RTC Oscillator Control, sample rate selection
0213h	C1h	Normal start; no rollover; 8-bit temp. log	General Mission Control
0214h	FFh	(Don't care)	Clock through read-only registers
0215h	FFh		
0216h	5Ah	90 minutes	Mission Start Delay
0217h	00h		
0218h	00h		

With only a single DS2422 connected to the bus master, the communication of step 2 looks like this:

MASTER MODE	DATA (LSB FIRST)	COMMENTS
TX	(Reset)	Reset pulse
RX	(Presence)	Presence pulse
TX	CCh	Issue "skip ROM" command
TX	0Fh	Issue "write scratchpad" command
TX	00h	TA1, beginning offset=00h
TX	02h	TA2, address=0200h
TX	<25 data bytes>	Write 25 bytes of data to scratchpad

MASTER MODE	DATA (LSB FIRST)	COMMENTS
TX	<7 FFh bytes>	Write through the end of the scratchpad
TX	(Reset)	Reset pulse
RX	(Presence)	Presence pulse
TX	CCh	Issue "skip ROM" command
TX	AAh	Issue "read scratchpad" command
RX	00h	Read TA1, beginning offset=00h
RX	02h	Read TA2, address=0200h
RX	1Fh	Read E/S, ending offset=1Fh, flags=0h
RX	<32 data bytes>	Read scratchpad data and verify
TX	(Reset)	Reset pulse
RX	(Presence)	Presence pulse
TX	CCh	Issue "skip ROM" command
TX	99h	Issue "copy scratchpad" command
TX	00h	TA1
TX	02h	TA2 (AUTHORIZATION CODE)
TX	1Fh	E/S
TX	<8 FFh bytes>	Send dummy password
TX	(Reset)	Reset pulse
RX	(Presence)	Presence pulse

STEP 3

Start the new mission.

With only a single DS2422 connected to the bus master, the communication of step 3 looks like this:

MASTER MODE	DATA (LSB FIRST)	COMMENTS
TX	(Reset)	Reset pulse
RX	(Presence)	Presence pulse
TX	CCh	Issue "skip ROM" command
TX	CCh	Issue "start mission" command
TX	<8 FFh bytes>	Send dummy password
TX	FFh	Send dummy byte
TX	(Reset)	Reset pulse
RX	(Presence)	Presence pulse

If step 3 was successful, the MIP bit in the General Status Register will be 1, the MEMCLR bit will be 0 and the mission start delay will count down.

PACKAGE INFORMATION

For the latest package outline information and land patterns, go to www.maxim-ic.com/packages. Note that a "+", "#", or "-" in the package code indicates RoHS status only. Package drawings may show a different suffix character, but the drawing pertains to the package regardless of RoHS status.

PACKAGE TYPE	PACKAGE CODE	DOCUMENT NO.
24 SO(W)	W24+4	21-0042

REVISION HISTORY

REVISION DATE	DESCRIPTION	PAGES CHANGED
11/03	Initial release	—
8/09	Added a plus sign (+) to the <i>Ordering Information</i> table to reflect this product's conversion to a lead-free device.	1
5/10	Changed the ALARM Output V_{OLMAX} specification from 0.6V to 0.7V.	3
	Applied EC table note 14 to t_{WOL} . Deleted ε from the t_{W1L} spec in the EC table. V_{TL}/V_{TH} clarification: Added to EC table note 5 the text ", which is a function of ..." Added to EC table notes 14 and 15 the reference to Figure 16 and the text "The actual maximum duration...." Added ε to the write zero time slot graphic in Figure 16.	3, 4, 41
	Changed the crystal part number in Note 16 and Figures 1, 2 from KDS SM14J to Seiko SPT2AF.	4, 7
	Specified the Application Note that explains the 2-point calibration trim and software correction.	4, 5, 22
	Update for improvements with B1 revision: Sample rate, EOSC bit.	13, 16, 24, 33
	Clarification of device behavior if SUTA = 1.	17, 25, 33
	Added 4 more codes to the Device Configuration Byte.	20
	Updated package information section.	48



Maxim cannot assume responsibility for use of any circuitry other than circuitry entirely embodied in a Maxim product. No circuit patent licenses are implied. Maxim reserves the right to change the circuitry and specifications without notice at any time. The parametric values (min and max limits) shown in the Electrical Characteristics table are guaranteed. Other parametric values quoted in this data sheet are provided for guidance.

Maxim Integrated 160 Rio Robles, San Jose, CA 95134 USA 1-408-601-1000

49