

Evaluating the **ADP5072** DC to DC Switching Regulator

FEATURES

Input supply voltage range: 3 V to 5.5 V

Output voltage: ± 15 V

Output current: up to 190 mA (V_{POS}), up to 90 mA (V_{NEG}),
depending on V_{IN}

EVALUATION KIT CONTENTS

ADP5072CB-EVALZ evaluation board

ADDITIONAL EQUIPMENT NEEDED

DC power supply

Multimeters for voltage and current measurement

Electronic or resistive loads

GENERAL DESCRIPTION

The ADP5072CB-EVALZ evaluation board demonstrates the functionality of the **ADP5072** dc to dc converter. The **ADP5072** is a dual high performance dc to dc regulator that generates independently regulated positive and negative rails.

Use the board to evaluate simple device measurements, such as line regulation, load regulation, and efficiency. Device features can be demonstrated, such as selectable operating frequency, soft start, sequencing, and slew rate control.

For more details about the **ADP5072**, refer to the **ADP5072** data sheet, which must be consulted in conjunction with this user guide when using the evaluation board.

ADP5072CB-EVALZ EVALUATION BOARD PHOTOGRAPH

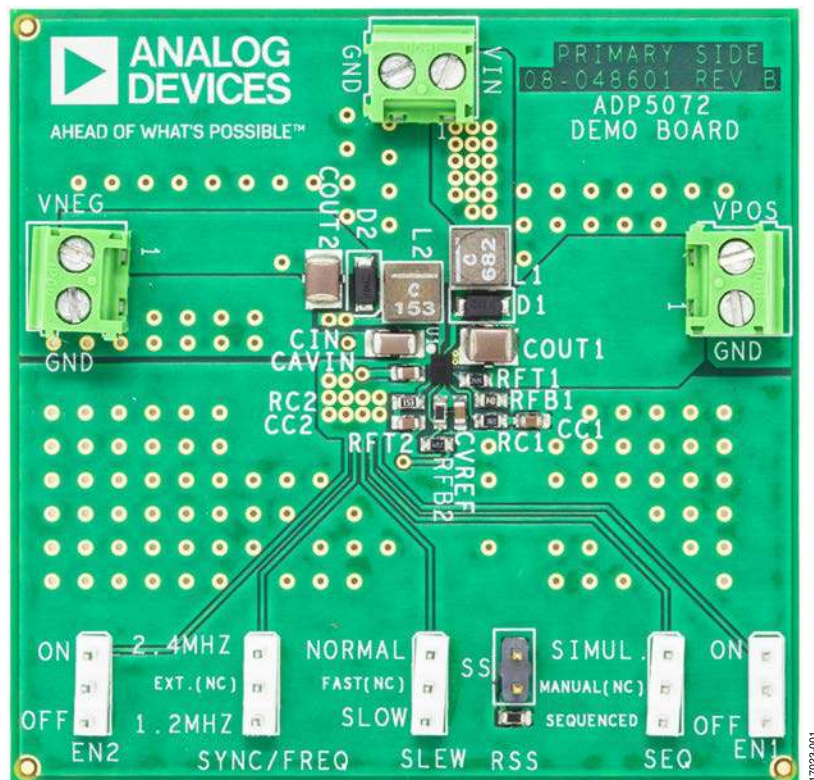

Figure 1.

TABLE OF CONTENTS

Features	1	Output Voltage Measurements	4
Evaluation Kit Contents.....	1	Line Regulation.....	4
Additional Equipment Needed	1	Load Regulation	5
General Description	1	Efficiency	5
ADP5072CB-EVALZ Evaluation Board Photograph	1	Evaluation Board Schematic	6
Revision History	2	Ordering Information.....	7
Evaluation Board Hardware.....	3	Bill of Materials.....	7
Evaluation Board Configurations	3		

REVISION HISTORY

1/2019—Revision 0: Initial Version

EVALUATION BOARD HARDWARE EVALUATION BOARD CONFIGURATIONS

The ADP5072CB-EVALZ evaluation board is configured to provide a $\pm 15\text{ V}$ output from a 3 V to 5.5 V input. Table 2 lists the components for the ADP5072CB-EVALZ board. The evaluation board allows the end user to customize the design. Figure 2 outlines the board features available to the user.

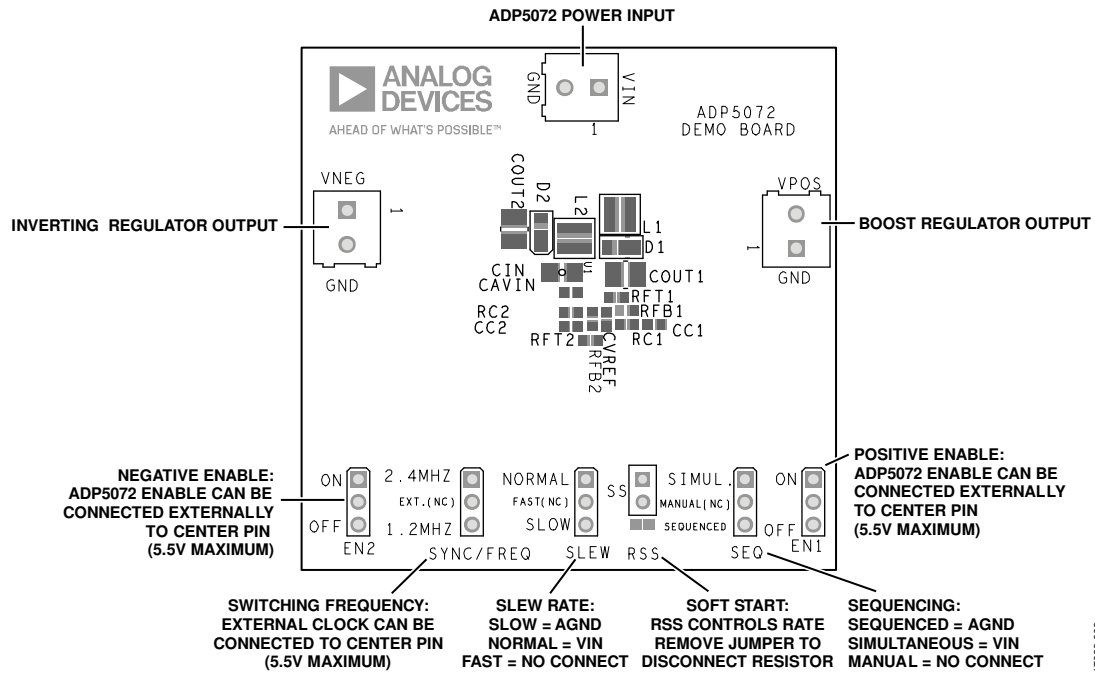

Figure 2. Outline of ADP5072CB-EVALZ Evaluation Board Features

Table 1. ADP5072CB-EVALZ Evaluation Board Connector Function Descriptions

Jumper/Connector Mnemonic	Description
VIN	Power supply to the ADP5072. In the default configuration, the power supply ranges from 3 V to 5.5 V.
VPOS	Output from boost regulator of the ADP5072. 15 V in default configuration.
VNEG	Output from inverting regulator of the ADP5072. -15 V in default configuration.
EN1	Boost regulator precision enable. The voltage of the EN1 pin is compared to an internal precision reference to enable the boost regulator output. Connect the EN1 jumper to the on position to turn on the boost regulator. Connect this jumper to the off position or remove this jumper to turn the regulator off (an internal pull-down is present in the ADP5072).
EN2	Inverting regulator precision enable. The voltage of the EN2 pin is compared to an internal precision reference to enable the inverting regulator output. Connect the EN2 jumper to the on position to turn on the inverting regulator. Connect this jumper to the off position or remove this jumper to turn the regulator off (an internal pull-down is present in the ADP5072).
SYNC/FREQ	Synchronization input and frequency setting. To set the switching frequency to 2.4 MHz, pull the SYNC pin high. To set the switching frequency to 1.2 MHz, pull the SYNC pin low. To synchronize the switching frequency, connect the SYNC pin to an external clock (5.5 V maximum).
SEQ	Start-up sequence control. For manual positive output voltage (V_{POS}) or negative output voltage (V_{NEG}) startup using an individual precision enabling pin, leave the SEQ pin open. For simultaneous V_{POS} and V_{NEG} startup when the EN2 pin rises, connect the SEQ pin to VIN (use the EN1 pin to enable internal references prior to startup if required). For a sequenced startup, pull the SEQ pin low. Use either EN1 or EN2 to enable V_{POS} or V_{NEG} and ensure that the corresponding supply is the first in sequence. Hold the other enable pin low.
SLEW	Driver stage slew rate control. The SLEW pin sets the slew rate for the SW1 and SW2 drivers. For the fastest slew rate (best efficiency), leave the SLEW pin open. For a normal slew rate, connect the SLEW pin to VIN. For the slowest slew rate (best noise performance), connect the SLEW pin to AGND.
RSS	Soft start programming. Leave the SS pin open to obtain the fastest soft start time. To program a slower soft start time, connect the RSS jumper. The RSS jumper connects the RSS resistor between the SS pin and AGND.

OUTPUT VOLTAGE MEASUREMENTS

For basic output voltage accuracy measurements, connect the evaluation board to a voltage source and a voltmeter. Use a resistor as the load for the regulator.

Ensure that the resistor has an adequate power rating to handle the expected power dissipation. Use an electronic load as an alternative. Ensure that the voltage source supplies enough current for the expected load levels, taking into account the device efficiency.

Follow these steps to connect to a voltage source and voltmeter:

1. Connect the negative (–) terminal of the voltage source to the GND terminal of the power input connector on the right side of the evaluation board.
2. Connect the positive (+) terminal of the voltage source to the VIN terminal of the power input connector on the right side of the evaluation board.
3. Connect a load between the VPOS or VNEG terminal and the GND terminal at the output connector (upper left and right of the printed circuit board (PCB)).
4. Connect the voltmeter across the selected output terminal and ground in parallel with the load resistor.
5. Turn the voltage source on. If the EN1 or EN2 jumper is in the on position, the respective boost or inverting regulator powers up.
6. Disconnect the SEQ jumper.

If the load current is large, the user must connect the voltmeter as close as possible to the output capacitor to reduce the effects of voltage drops due to PCB trace impedance.

If long power leads are used from the power supply, especially at higher loads, connect a large capacitor across the VIN terminals to prevent losses from lead inductance. Measure the input voltage at these terminals or use a power supply with a 4-wire supply and sense arrangement.

LINE REGULATION

For line regulation measurements, monitor the regulator output while its input is varied. For optimal line regulation, the output must change as little as possible with varying input levels. It is possible to repeat this measurement under different load conditions. During line regulation tests, keep the power supply leads short and remove any additional input capacitors. Figure 3 and Figure 4 show the typical line regulation performance of the ADP5072 at both the output and feedback pins.

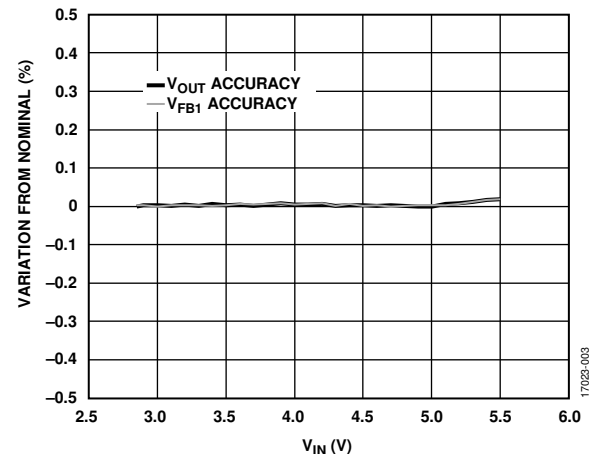

Figure 3. Boost Regulator Line Regulation, $V_{POS} = 15\text{ V}$, Switching Frequency (f_{SW}) = 1.2 MHz, 15 mA Load, $T_A = 25^\circ\text{C}$

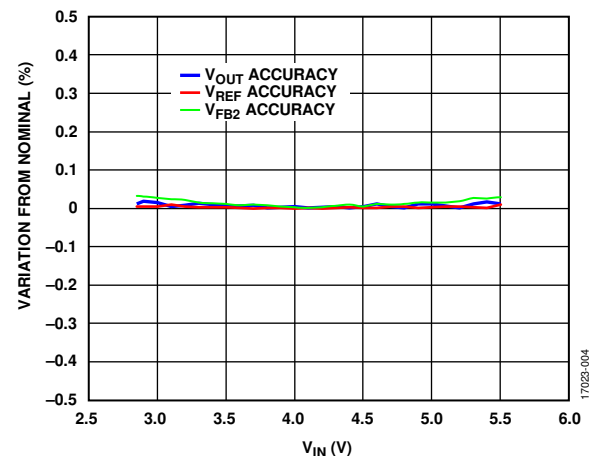

Figure 4. Inverting Regulator Line Regulation, $V_{NEG} = -15\text{ V}$, $f_{SW} = 1.2\text{ MHz}$, 15 mA Load, $T_A = 25^\circ\text{C}$

LOAD REGULATION

For load regulation measurements, monitor the regulator output while the load is varied. For optimal load regulation, the output must change as little as possible with varying loads. The input voltage must be held constant during load regulation measurement. Figure 5 and Figure 6 show the typical load regulation performance of the ADP5072 at both the output and feedback pins. Keep power leads short during load regulation measurement and use a power supply with remote sense.

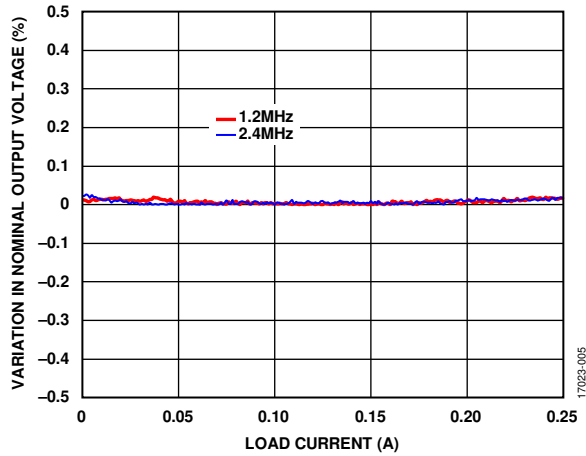

Figure 5. Boost Regulator Load Regulation, Input Supply Voltage Range ($V_{IN} = 5\text{ V}$, $V_{POS} = 15\text{ V}$)

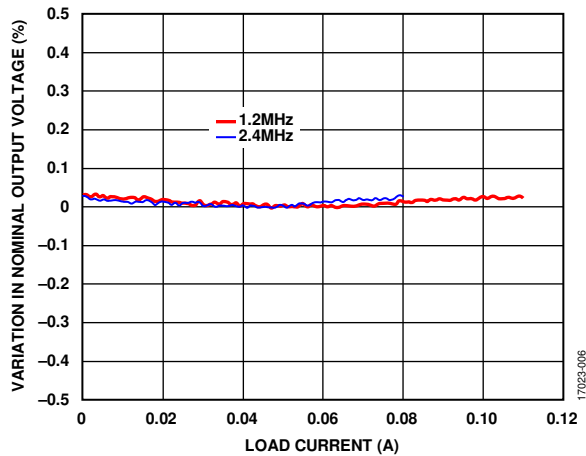

Figure 6. Inverting Regulator Load Regulation, $V_{IN} = 5\text{ V}$, $V_{NEG} = -15\text{ V}$

EFFICIENCY

For efficiency measurements, monitor the regulator input and output while the load is varied. The input voltage must be held constant during efficiency measurements. Keep power leads short during this test and use a power supply with remote sense. Connect ammeters in series with the input and output. Connect voltmeters to the PCB side of the ammeter and measure the voltage across the input and output terminals. For the best results, measure the voltage across the input and output capacitors. If possible, particularly at low current, trigger the meters simultaneously and set the meters to average readings for a period of a few hundred milliseconds or more. Averaging the readings removes the switching ripple and skip mode effects. Figure 7 and Figure 8 show typical efficiency curves using 3.3 V and 5 V inputs.

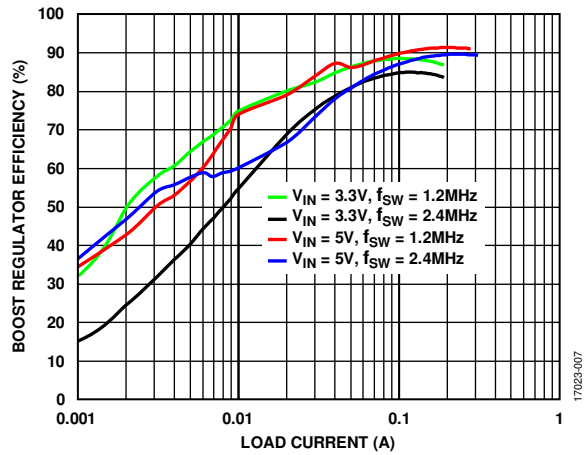

Figure 7. Boost Regulator Efficiency vs. Load Current, $V_{POS} = 15\text{ V}$, $T_A = 25^\circ\text{C}$

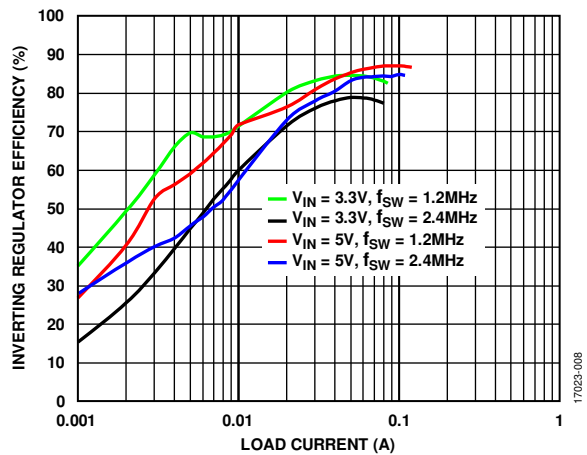

Figure 8. Inverting Regulator Efficiency vs. Load Current, $V_{NEG} = -15\text{ V}$, $T_A = 25^\circ\text{C}$

EVALUATION BOARD SCHEMATIC

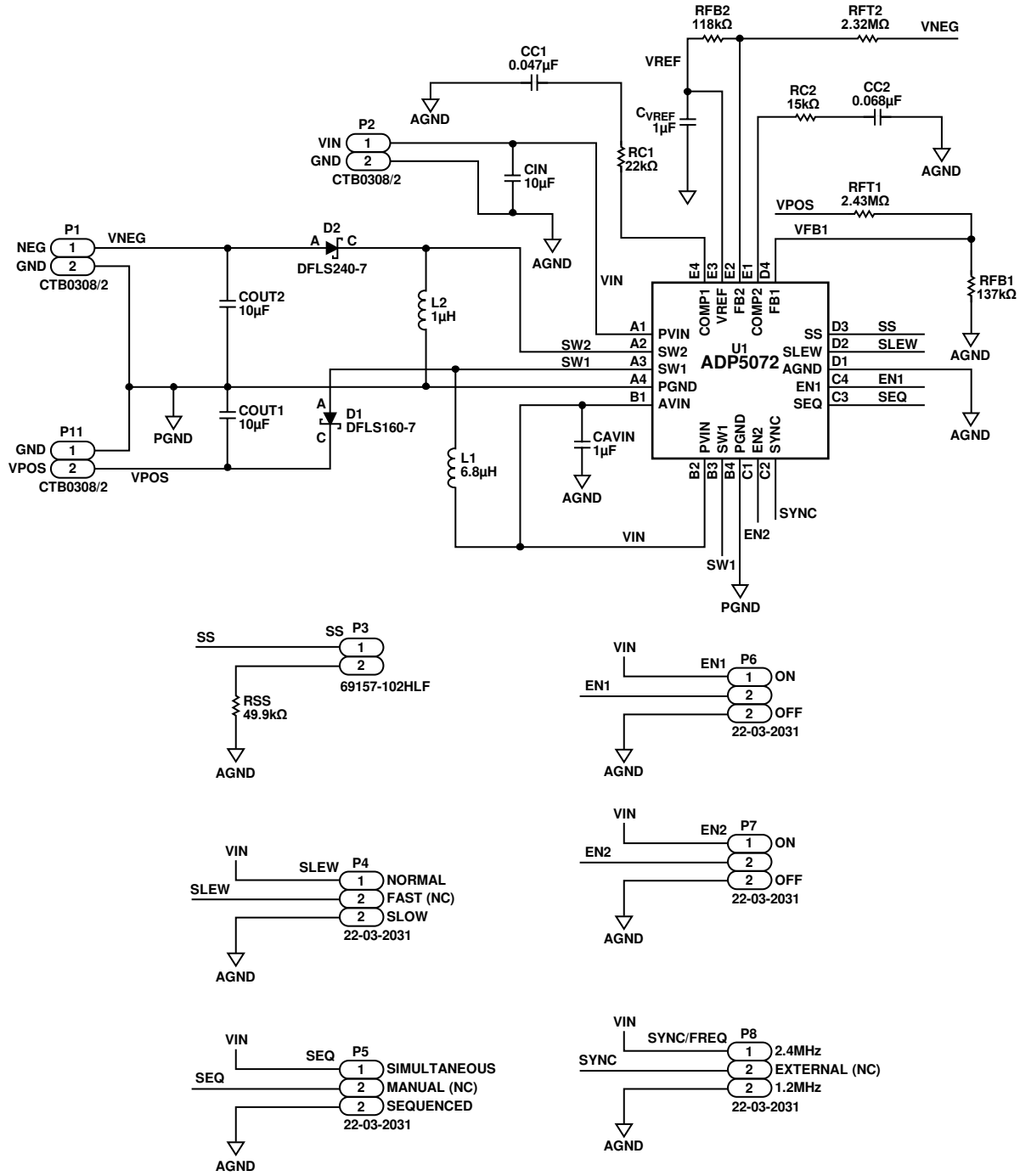

Figure 9. Evaluation Board Schematic for the ADP5072CB-EVALZ

17023-009

ORDERING INFORMATION

BILL OF MATERIALS

Table 2.

Component	Package	Description	Value	Tolerance	Voltage	Part Number	Manufacturer
U1	WLCSP	ADP5072 WLCSP	ADP5072	Not applicable	Not applicable	Not applicable	Analog Devices, Inc.
COUT1	1210	V _{POS} capacitor	10 μ F	10%	50 V	GRM32ER71H106KA12L	Murata
COUT2	1210	V _{NEG} capacitor	10 μ F	10%	50 V	GRM32ER71H106KA12L	Murata
L1	XAL40xx	V _{POS} inductor	6.8 μ H	20%	Not applicable	XAL4030-682ME	Coilcraft
L2	XAL40xx	V _{NEG} inductor	15 μ H	20%	Not applicable	XAL4030-153ME	Coilcraft
D1	POWERDI123	V _{POS} diode	Schottky	Not applicable	40 V	DFLS160-7	Diodes Incorporated
D2	DSML110W70H39	V _{NEG} diode	Schottky	Not applicable	40 V	DFLS240-7	Diodes Incorporated
CC1	603	Boost regulator compensation capacitor	47 nF	10%	50 V	Not applicable	Not applicable
CC2	603	Inverting regulator compensation capacitor	68 nF	10%	100 V	Not applicable	Not applicable
RC1	603	Boost regulator compensation resistor	22 k Ω	1%	Not applicable	Not applicable	Not applicable
RC2	603	Inverting regulator compensation resistor	15 k Ω	1%	Not applicable	Not applicable	Not applicable
RFT1	805	V _{POS} top feedback resistor	2.43 M Ω	1%	Not applicable	Not applicable	Not applicable
RFB1	805	V _{POS} bottom feedback resistor	137 k Ω	1%	Not applicable	Not applicable	Not applicable
RFT2	805	V _{NEG} top feedback resistor	2.32 M Ω	1%	Not applicable	Not applicable	Not applicable
RFB2	805	V _{NEG} bottom feedback resistor	118 k Ω	1%	Not applicable	Not applicable	Not applicable
RSS	603	Soft start programming resistor	49.9 k Ω	1%	Not applicable	Not applicable	Not applicable
CIN	1206	C _{IN} capacitor	10 μ F	10%	25 V	TMK316B7106KL-TD	Taiyo Yuden
CAVIN	603	C _{AVIN} capacitor	1 μ F	10%	10 V	GRM188R71A105KA61D	Murata
CVREF	603	V _{REF} capacitor	1 μ F	10%	10 V	GRM188R71A105KA61D	Murata

NOTES

**ESD Caution**

ESD (electrostatic discharge) sensitive device. Charged devices and circuit boards can discharge without detection. Although this product features patented or proprietary protection circuitry, damage may occur on devices subjected to high energy ESD. Therefore, proper ESD precautions should be taken to avoid performance degradation or loss of functionality.

Legal Terms and Conditions

By using the evaluation board discussed herein (together with any tools, components documentation or support materials, the "Evaluation Board"), you are agreeing to be bound by the terms and conditions set forth below ("Agreement") unless you have purchased the Evaluation Board, in which case the Analog Devices Standard Terms and Conditions of Sale shall govern. Do not use the Evaluation Board until you have read and agreed to the Agreement. Your use of the Evaluation Board shall signify your acceptance of the Agreement. This Agreement is made by and between you ("Customer") and Analog Devices, Inc. ("ADI"), with its principal place of business at One Technology Way, Norwood, MA 02062, USA. Subject to the terms and conditions of the Agreement, ADI hereby grants to Customer a free, limited, personal, temporary, non-exclusive, non-sublicensable, non-transferable license to use the Evaluation Board FOR EVALUATION PURPOSES ONLY. Customer understands and agrees that the Evaluation Board is provided for the sole and exclusive purpose referenced above, and agrees not to use the Evaluation Board for any other purpose. Furthermore, the license granted is expressly made subject to the following additional limitations: Customer shall not (i) rent, lease, display, sell, transfer, assign, sublicense, or distribute the Evaluation Board; and (ii) permit any Third Party to access the Evaluation Board. As used herein, the term "Third Party" includes any entity other than ADI, Customer, their employees, affiliates and in-house consultants. The Evaluation Board is NOT sold to Customer; all rights not expressly granted herein, including ownership of the Evaluation Board, are reserved by ADI. CONFIDENTIALITY. This Agreement and the Evaluation Board shall all be considered the confidential and proprietary information of ADI. Customer may not disclose or transfer any portion of the Evaluation Board to any other party for any reason. Upon discontinuation of use of the Evaluation Board or termination of this Agreement, Customer agrees to promptly return the Evaluation Board to ADI. ADDITIONAL RESTRICTIONS. Customer may not disassemble, decompile or reverse engineer chips on the Evaluation Board. Customer shall inform ADI of any occurred damages or any modifications or alterations it makes to the Evaluation Board, including but not limited to soldering or any other activity that affects the material content of the Evaluation Board. Modifications to the Evaluation Board must comply with applicable law, including but not limited to the RoHS Directive. TERMINATION. ADI may terminate this Agreement at any time upon giving written notice to Customer. Customer agrees to return to ADI the Evaluation Board at that time. LIMITATION OF LIABILITY. THE EVALUATION BOARD PROVIDED HEREUNDER IS PROVIDED "AS IS" AND ADI MAKES NO WARRANTIES OR REPRESENTATIONS OF ANY KIND WITH RESPECT TO IT. ADI SPECIFICALLY DISCLAIMS ANY REPRESENTATIONS, ENDORSEMENTS, GUARANTEES, OR WARRANTIES, EXPRESS OR IMPLIED, RELATED TO THE EVALUATION BOARD INCLUDING, BUT NOT LIMITED TO, THE IMPLIED WARRANTY OF MERCHANTABILITY, TITLE, FITNESS FOR A PARTICULAR PURPOSE OR NON-INFRINGEMENT OF INTELLECTUAL PROPERTY RIGHTS. IN NO EVENT WILL ADI AND ITS LICENSORS BE LIABLE FOR ANY INCIDENTAL, SPECIAL, INDIRECT, OR CONSEQUENTIAL DAMAGES RESULTING FROM CUSTOMER'S POSSESSION OR USE OF THE EVALUATION BOARD, INCLUDING BUT NOT LIMITED TO LOST PROFITS, DELAY COSTS, LABOR COSTS OR LOSS OF GOODWILL. ADI'S TOTAL LIABILITY FROM ANY AND ALL CAUSES SHALL BE LIMITED TO THE AMOUNT OF ONE HUNDRED US DOLLARS (\$100,000). EXPORT. Customer agrees that it will not directly or indirectly export the Evaluation Board to another country, and that it will comply with all applicable United States federal laws and regulations relating to exports. GOVERNING LAW. This Agreement shall be governed by and construed in accordance with the substantive laws of the Commonwealth of Massachusetts (excluding conflict of law rules). Any legal action regarding this Agreement will be heard in the state or federal courts having jurisdiction in Suffolk County, Massachusetts, and Customer hereby submits to the personal jurisdiction and venue of such courts. The United Nations Convention on Contracts for the International Sale of Goods shall not apply to this Agreement and is expressly disclaimed.