



**Ultra Low Profile 0805
5dB Directional Coupler**

Description:

The X4C20J1-05G is a low cost, low profile sub-miniature high performance 5 dB directional coupler in a new easy to use, manufacturing friendly surface mount package. It is designed for 1700 – 2300MHz applications including: 5G applications. It can be used in high power applications up to 5 Watts.

All of the Xinger components are constructed from ceramic filled PTF composites, which possess excellent electrical and mechanic stability. Produced with 6 of 6 RoHS compliant ENIG finish.

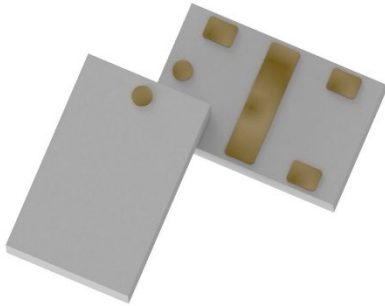

Features:

- 1700-2300 MHz
- 5G Applications
- High Power
- Very Low Loss
- Tight Amplitude Balance
- High Isolation
- Production Friendly
- Tape and Reel
- RoHS Compliant
- Halogen Free

Electrical Specifications**

Frequency	Coupling	Insertion Loss	Return Loss
<i>MHz</i>	<i>dB</i>	<i>dB Max</i>	<i>dB Min</i>
1700-2300	5.0 ± 0.5	0.5	20
Isolation	Phase Balance	Power	Operating Temp.
<i>dB Min</i>	<i>Degrees</i>	<i>Avg. CW Watts @105 °C</i>	<i>°C</i>
25	90 ±4	5	-55 to +140

**Specification based on performance of unit properly installed on TTM Test Board with small signal applied.

*Specifications subject to change without notice. Refer to parameter definitions for details.

Mechanical Outline:

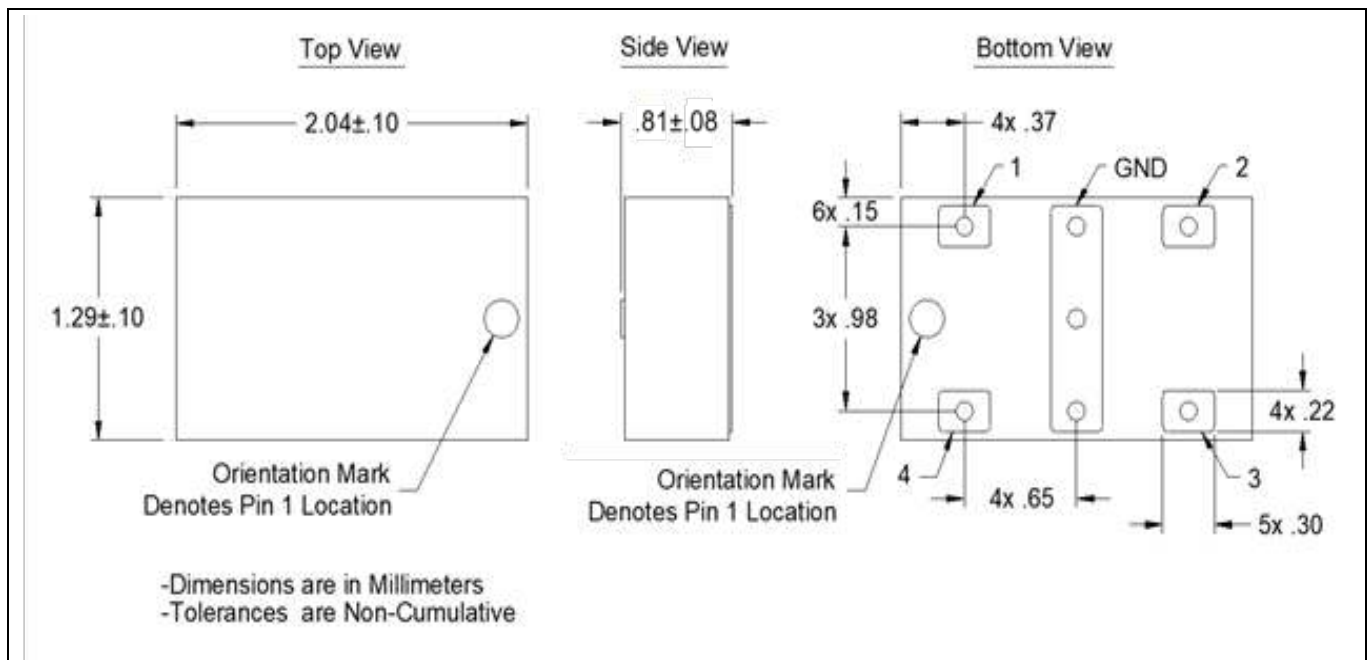

Hybrid Coupler Pin Configuration

The X4C20J1-05G has an orientation marker to denote Pin 1. Once port one has been identified the other ports are known automatically. Please see the chart below for clarification.

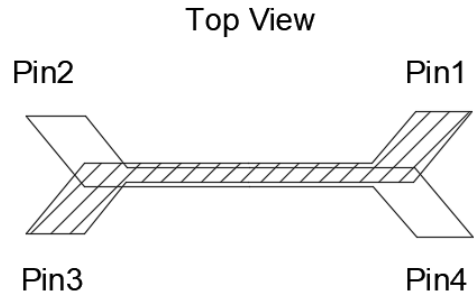

5dB Coupler Pin Configuration

Pin 1	Pin 2	Pin 3	Pin 4
Input	Isolated	Direct	Coupled
Isolated	Input	Coupled	Direct
Direct	Coupled	Input	Isolated
Coupled	Direct	Isolated	Input

Note: The direct port has a DC connection to the input port and the coupled port has a DC connection to the isolated port. For optimum IL and power handling performance, use Pin 1 or Pin 3 as inputs.

Insertion Loss and Power Derating Curves

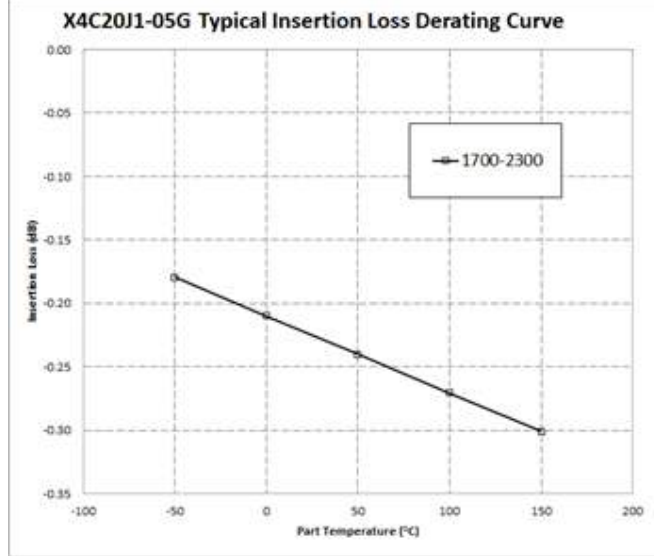

Insertion Loss Derating

The insertion loss, at a given frequency, of a group of couplers is measured at 25°C and then averaged. The measurements are performed under small signal conditions (i.e. using a Vector Network Analyzer). The process is repeated at -55°C, 105°C and 140°C. A best-fit line for the measured data is computed and then plotted from -55°C to 140°C.

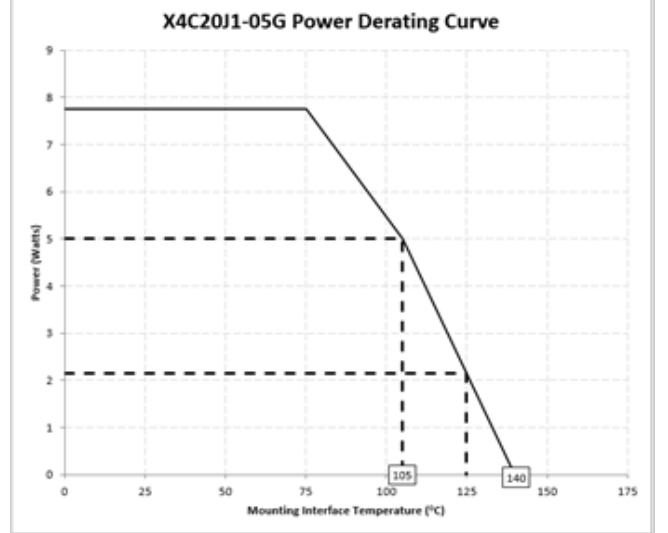

Power Derating

The power handling and corresponding power derating plots are a function of the thermal resistance, mounting surface temperature (base plate temperature), maximum continuous operating temperature of the coupler, and the thermal insertion loss. The thermal insertion loss is defined in the Power Handling section of the data sheet.

As the mounting interface temperature approaches the maximum continuous operating temperature, the power handling decreases to zero.

If mounting temperature is greater than 105°C, Xinger coupler will perform reliably as long as the input power is derated to the curve above.

Typical Performance 1500 MHz to 2500 MHz

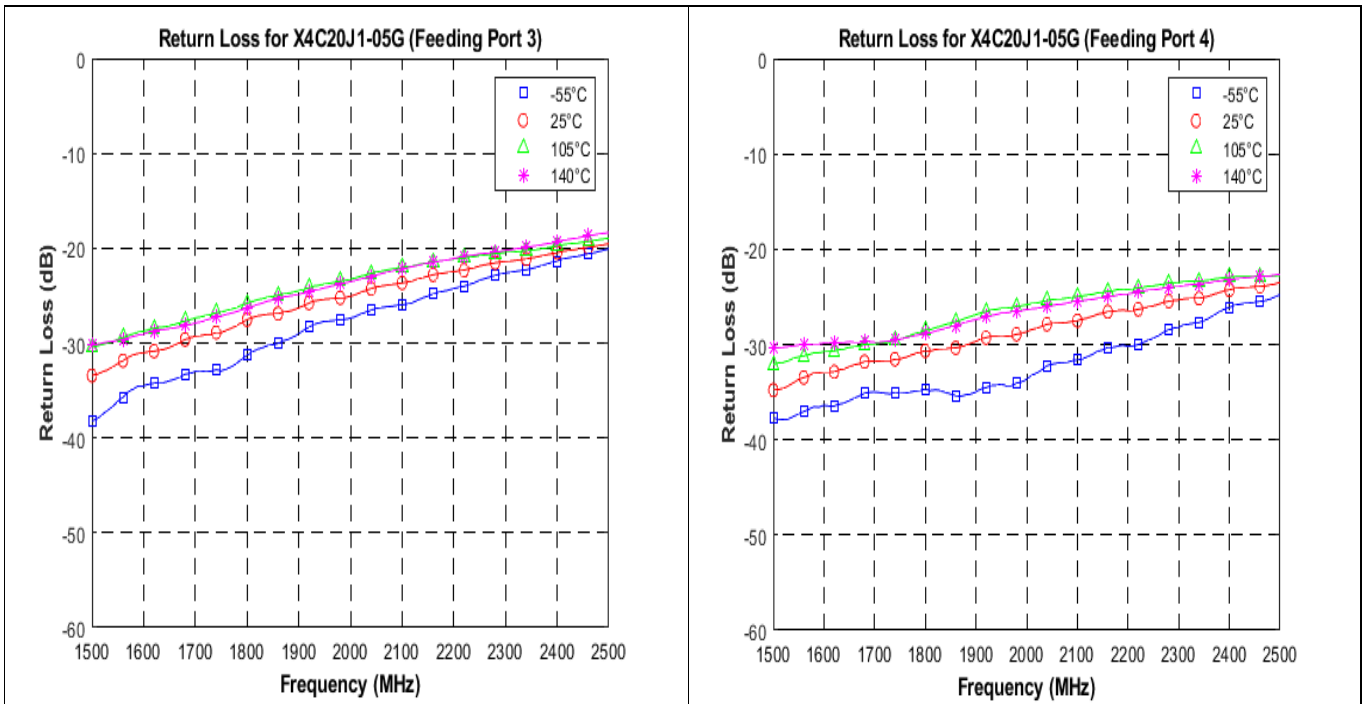
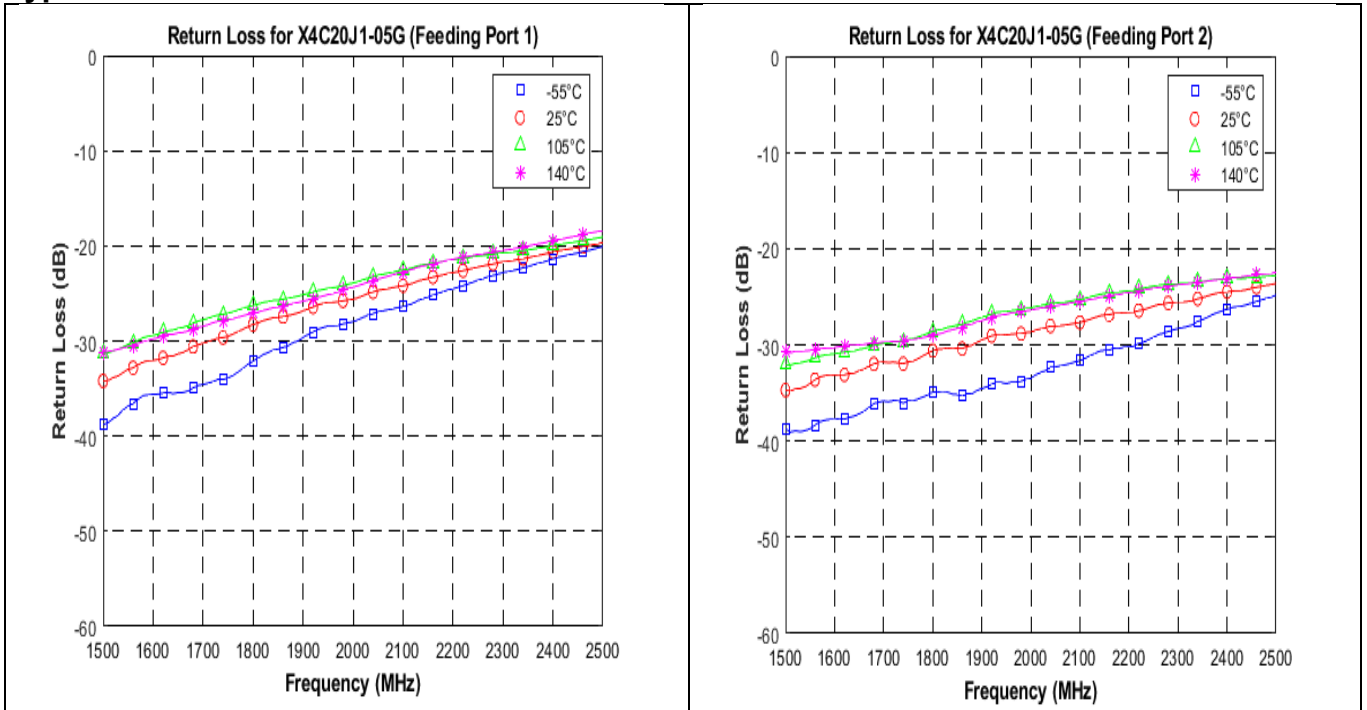

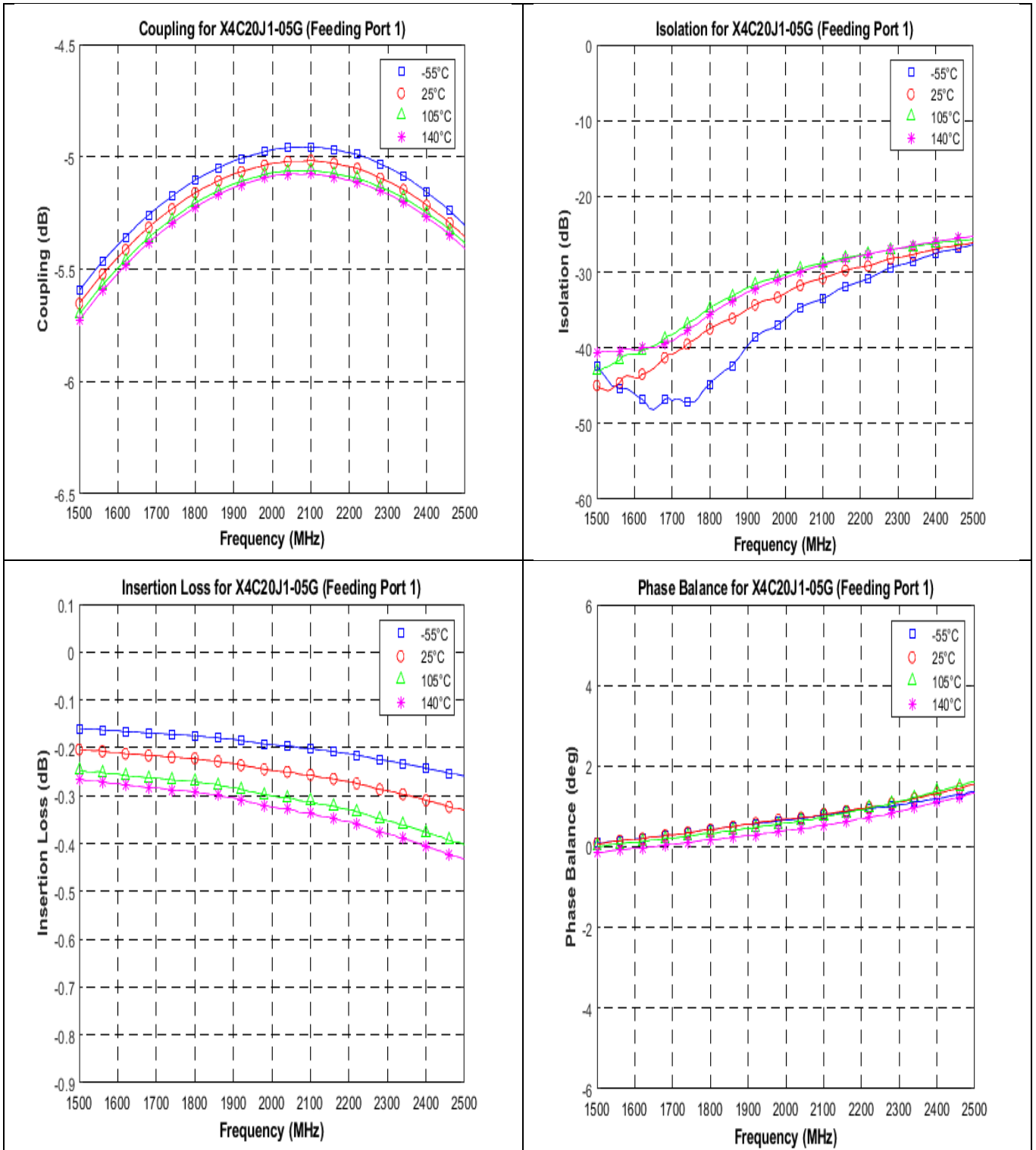

Definition of Measured Specifications

Parameter	Definition	Mathematical Representation
VSWR (Voltage Standing Wave Ratio)	The impedance match of the coupler to a 50Ω system. A VSWR of 1:1 is optimal.	$VSWR = \frac{V_{max}}{V_{min}}$ Vmax = voltage maxima of a standing wave Vmin = voltage minima of a standing wave
Return Loss	The impedance match of the coupler to a 50Ω system. Return Loss is an alternate means to express VSWR.	$\text{Return Loss(dB)} = 20\log \frac{VSWR + 1}{VSWR - 1}$
Insertion Loss	The input power divided by the sum of the power at the two output ports.	$\text{Insertion Loss(dB)} = 10\log \frac{P_{in}}{P_{cpl} + P_{direct}}$
Isolation	The input power divided by the power at the isolated port.	$\text{Isolation(dB)} = 10\log \frac{P_{in}}{P_{iso}}$
Phase Balance	The difference in phase angle between the two output ports.	Phase at coupled port - Phase at direct port
Coupling	At a given frequency (ω_n), coupling is the input power divided by the power at the coupled port.	$\text{Coupling(dB)} = C(\omega_n) = 10\log \frac{P_{in}(\omega_n)}{P_{cpl}(\omega_n)}$
Group Delay	Group delay is average of group delay's from input port to the coupled port	Average (GD-C)

Packaging and Ordering Information:

Parts are available in reel and are packaged per EIA 481-D. Parts are oriented in tape and reel as shown below. Minimum order quantities are 4000 per reel.

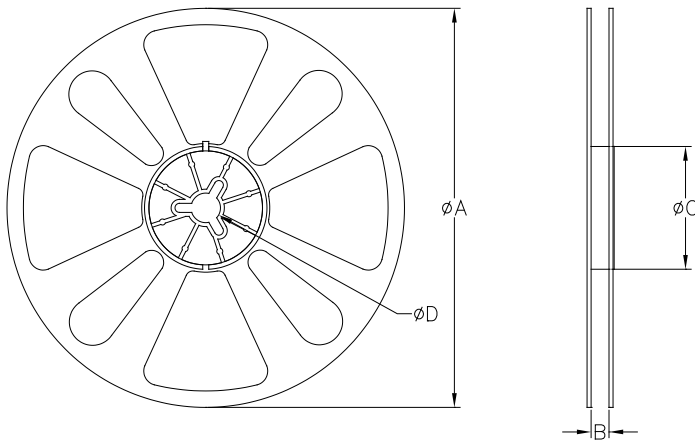
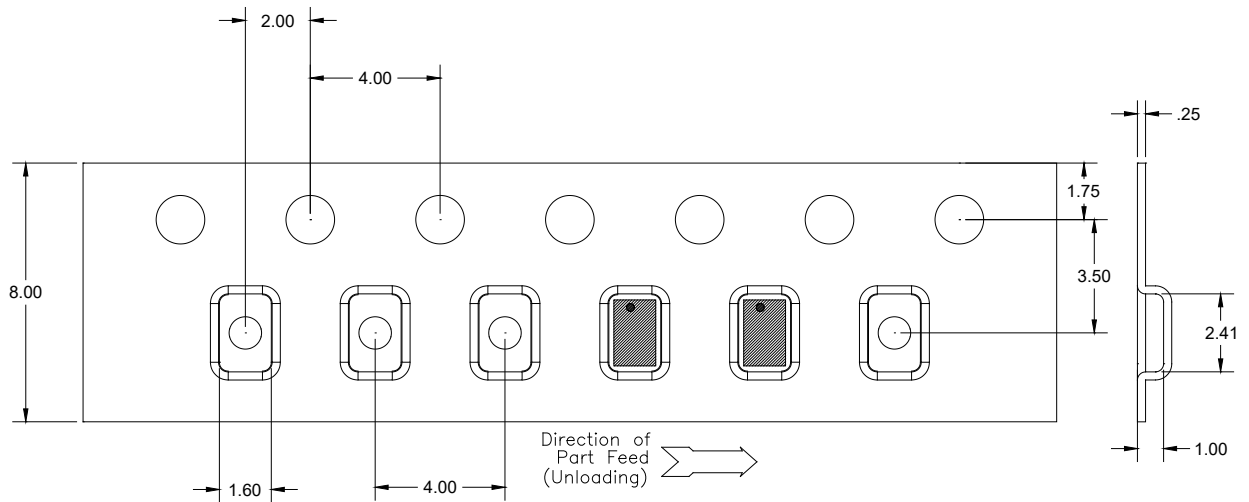

QUANTITY/REEL	REEL DIMENSIONS mm	
4000	φA	177.80
	B	8.00
	φC	50.80
	φD	13.00

Contact us:
rf&s_support@ttm.com