

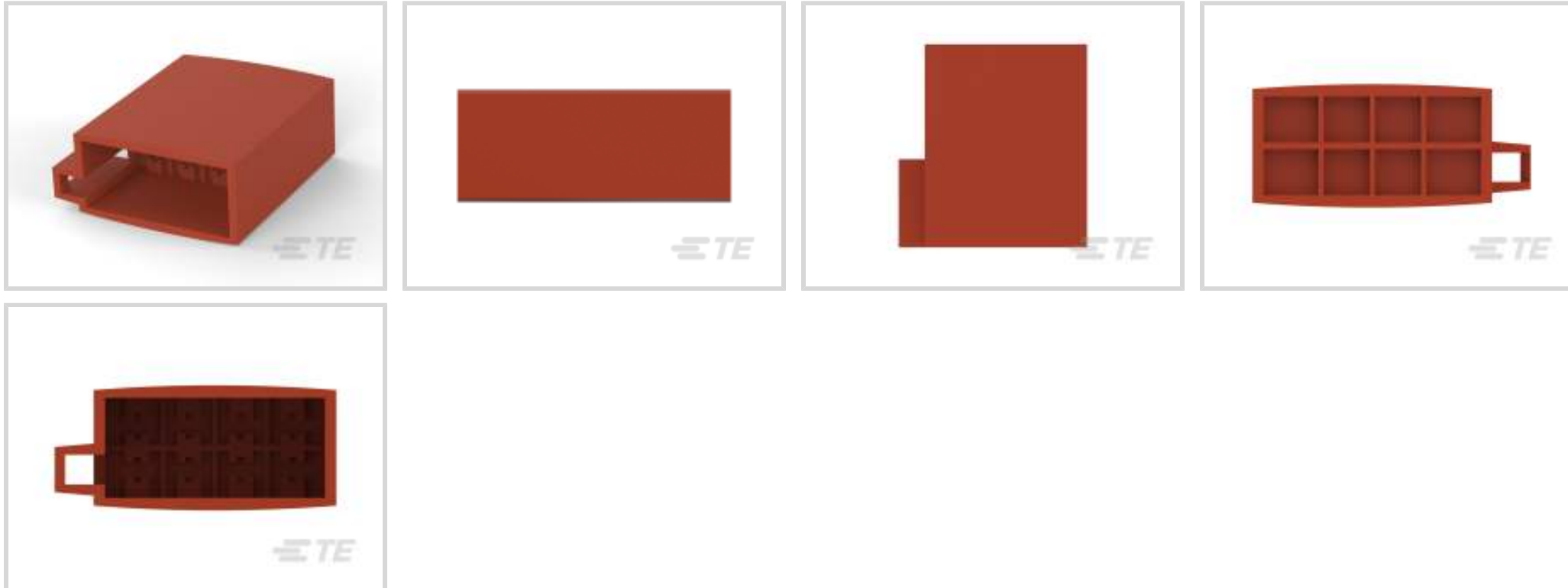

Terminals & Splices > Terminal Housings, Insulation Sleeves & Blocks > Crimp Terminal Housings



Terminal Type: **Tab**

Connector & Housing Type: **Tab Housing**

Number of Positions: **8**

Terminal Orientation: **Straight**

Primary Product Color: **Brown**

### Features

#### Product Type Features

Sealable	No
Connector & Housing Type	Tab Housing

#### Configuration Features

Number of Positions	8
---------------------	---

#### Body Features

Primary Product Color	Brown
-----------------------	-------

#### Contact Features

Terminal Type	Tab
Terminal Orientation	Straight
Contact Mating Retention	With

#### Mechanical Attachment

Mating Retention Type	Latch
Mating Alignment	With



Connector Mounting Type	Cable Mount (Free-Hanging)
-------------------------	----------------------------

### Housing Features

Housing Material	PBT
Centerline (Pitch)	6 mm[.236 in]

### Dimensions

Product Length	35 mm[1.38 in]
----------------	----------------

### Usage Conditions

Operating Temperature Range	-40 – 105 °C[-40 – 221 °F]
-----------------------------	----------------------------

### Packaging Features

Packaging Quantity	800
Packaging Method	Carton

## Product Compliance

[For compliance documentation, visit the product page on TE.com>](#)

EU RoHS Directive 2011/65/EU	Compliant
EU ELV Directive 2000/53/EC	Compliant
China RoHS 2 Directive MIIT Order No 32, 2016	No Restricted Materials Above Threshold
EU REACH Regulation (EC) No. 1907/2006	Current ECHA Candidate List: JUNE 2023 (235) Candidate List Declared Against: JUNE 2023 (235) Does not contain REACH SVHC
Halogen Content	Low Halogen - Br, Cl, F, I < 900 ppm per homogenous material. Also BFR/CFR/PVC Free
Solder Process Capability	Not applicable for solder process capability

#### Product Compliance Disclaimer

This information is provided based on reasonable inquiry of our suppliers and represents our current actual knowledge based on the information they provided. This information is subject to change. The part numbers that TE has identified as EU RoHS compliant have a maximum concentration of 0.1% by weight in homogenous materials for lead, hexavalent chromium, mercury, PBB, PBDE, DBP, BBP, DEHP, DIBP, and 0.01% for cadmium, or qualify for an exemption to these limits as defined in the Annexes of Directive 2011/65/EU (RoHS2). Finished electrical and electronic equipment products will be CE marked as required by Directive 2011/65/EU. Components may not be CE marked. Additionally, the part numbers that TE has identified as EU ELV compliant have a maximum concentration of 0.1% by weight in homogenous materials for lead, hexavalent chromium, and mercury, and 0.01% for cadmium, or qualify for an exemption to these limits as defined in the Annexes of Directive 2000/53/EC (ELV). Regarding the REACH Regulation, the information TE provides on SVHC in articles for this part number is based on the latest European Chemicals Agency (ECHA) 'Guidance on requirements for substances in articles' posted at this URL: <https://echa.europa.eu/guidance-documents/guidance-on-reach>



### Compatible Parts

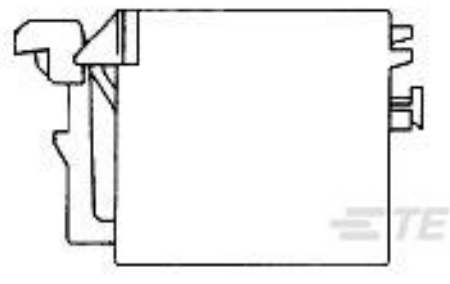

TE Part # 347782-1  
8 POS RADIO CONNECTOR



TE Part # 338696-1  
FASTIN FASTON (FF) HOUSING TAB



TE Part # 9-144836-5  
DOUBLE LOCKING 5 MM HOUSING TAB PA66

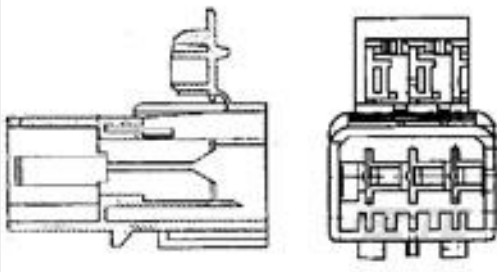

TE Part # 1-144836-5  
HOUSING TAB 5MM 5 P BROWN



TE Part # 5-144835-3  
HOUSING TAB 5MM 3 P GREEN



TE Part # 6-316441-6  
FF 187 PLUG 8P ASSY LIGHT GRAY



TE Part # 964473-1  
FF 110 TAB HSG 10P PBT BLACK

### Also in the Series | FASTIN-FASTON 110



Automotive Housings(6)



Automotive Terminals(6)



Crimp Terminal Housings(34)



Insertion & Extraction Tools(3)



Quick Disconnects(83)

### Customers Also Bought

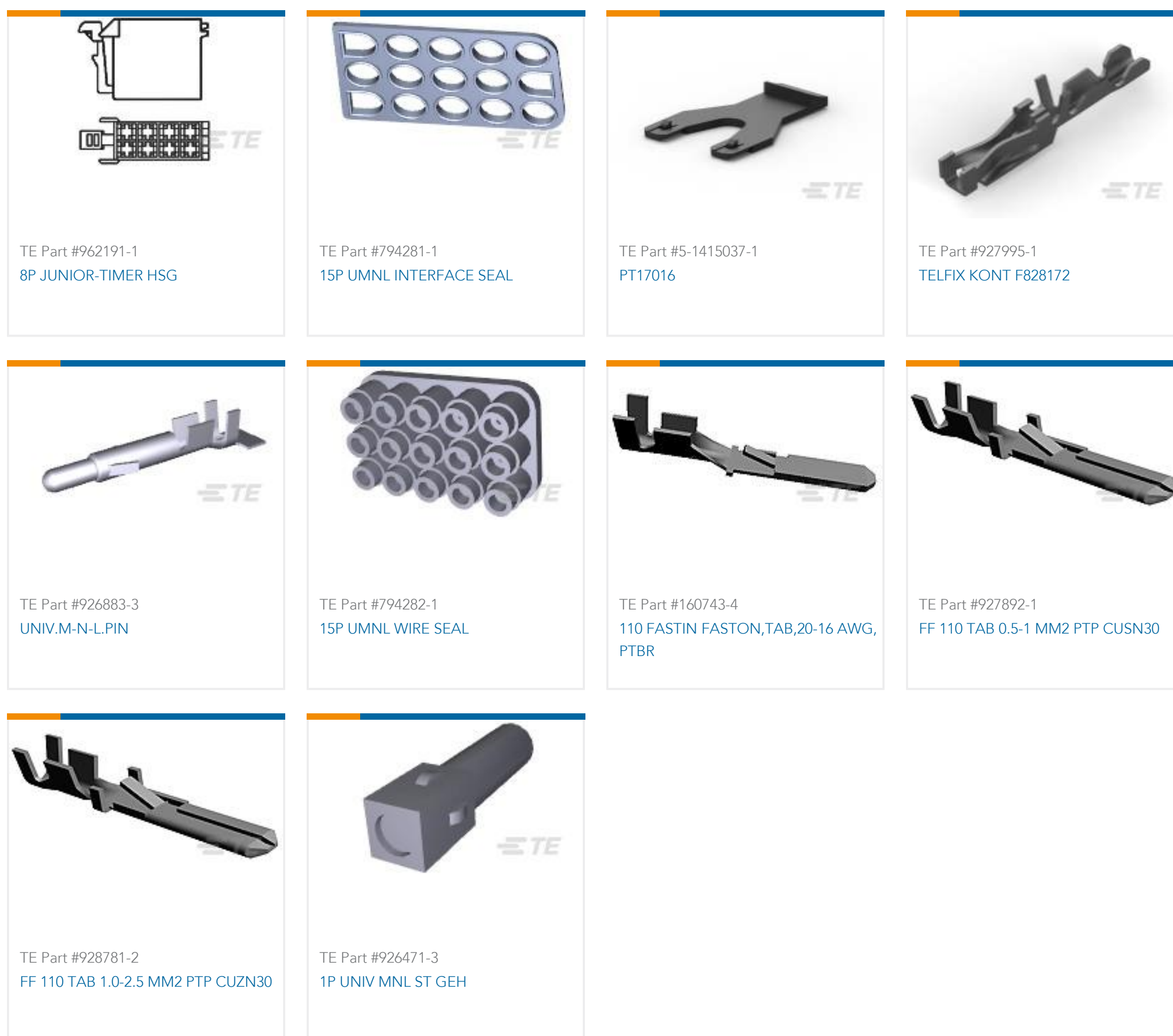

## Documents

### Product Drawings

[FF 110 PLUG HSG 8P.](#)

English

### CAD Files

[3D PDF](#)

3D

Customer View Model

[ENG\\_CVM\\_CVM\\_106455-4\\_A.2d\\_dxf.zip](#)

English

Customer View Model

[ENG\\_CVM\\_CVM\\_106455-4\\_A.3d\\_igs.zip](#)

English

Customer View Model

[ENG\\_CVM\\_CVM\\_106455-4\\_A.3d\\_stp.zip](#)

English

By downloading the CAD file I accept and agree to the [Terms and Conditions](#) of use.

### Datasheets & Catalog Pages



### White Paper: Nylon Discoloration

English

---

### Product Specifications

#### Application Specification

English

---

### Product Environmental Compliance

#### Product Compliance

English

#### Product Compliance

English