



The Future of Analog IC Technology®

EVM3683-7-QN-01A

16V, 8A DC/DC Power Module
Evaluation Board

DESCRIPTION

The EVM3683-7-QN-01A Evaluation Board is designed to demonstrate the capabilities of MPS' MPM3683-7. The MPM3683-7 is an easy-to-use fully integrated peak 10A, continuous 8A step-down DC/DC power module. MPM3683-7 can deliver output current over a wide input supply voltage range with excellent load and line regulation.

The MPM3683-7 uses Constant-On-Time (COT) control to provide fast transient response and ease the loop stabilization.

The operating frequency is set easily to 600 kHz, 800 kHz, or 1000 kHz with the MODE configuration, allowing the MPM3683-7 frequency to remain constant regardless of the input/output voltages.

The MPM3683-7 is available in a space-saving QFN-28 (7mmx7mmx4mm) package.

ELECTRICAL SPECIFICATIONS

Parameter	Symbol	Value	Units
Input Voltage	V _{IN}	4 to 16	V
Output Voltage	V _{OUT}	1.2	V
Output Current	I _{OUT}	10	A

FEATURES

- Wide Input Voltage Range from 2.7V:
 - 2.7V to 16V with External 3.3V Bias
 - 4V to 16V with Internal Bias or External 3.3V Bias
- Differential Output Voltage Remote Sense
- Peak 10A, Continuous 8A Output Current
- Adaptive Constant-on-Time (COT) for Ultra-Fast Transient Response
- Selectable Pulse Skip Mode or Forced Continuous Conduction Mode (FCCM)
- Output Voltage Discharge
- Pre-Bias Start-Up
- Selectable Switching Frequency from 600kHz, 800kHz, and 1000kHz
- Non-Latch OCP, UVP, UVLO, Thermal Shutdown, and OVP
- Adjustable Output from 0.6V Up to 5.5V (5.5V Max)
- QFN-28 (7mm x 7mm x 4mm) package

APPLICATIONS

- Telecom and Networking Systems
- Base Stations
- Industrial Systems
- Servers and Storage

All MPS parts are lead-free, halogen-free, and adhere to the RoHS directive. For MPS green status, please visit the MPS website under Quality Assurance. "MPS", the MPS logo, and "Simple, Easy Solutions" are trademarks of Monolithic Power Systems, Inc. or its subsidiaries.

EVM3683-7-QN-01A EVALUATION BOARD

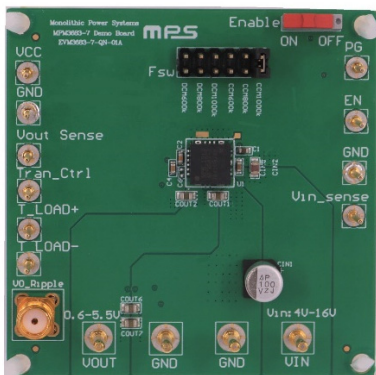

LxWxH (6.4cmx6.4cmx1.3cm)

Board Number	MPS IC Number
EVM3683-7-QN-01A	MPM3683-7

Efficiency

V_{IN} = 4V/12V/16V, V_{OUT} = 1.2V,
I_{OUT} = 0A to 10A

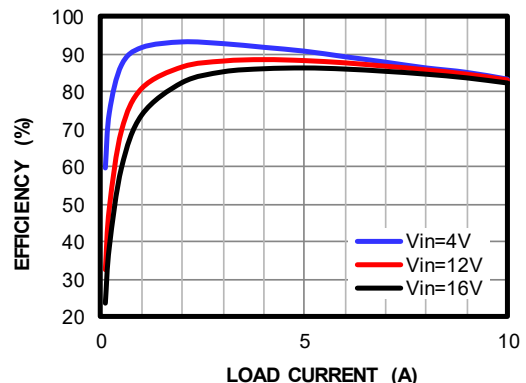

QUICK START GUIDE

1. Connect the positive and negative terminals of the load to the VOUT and GND pins, respectively.
2. Preset the power supply output between 4V and 16V, and then turn off the power supply.
3. Connect the positive and negative terminals of the power supply output to the VIN and GND pins, respectively.
4. Before turn the power supply, choose the suitable Fsw by Jumper connector (JP1).
5. Turn the power supply on. The board will automatically start up.

EVALUATION BOARD SCHEMATIC

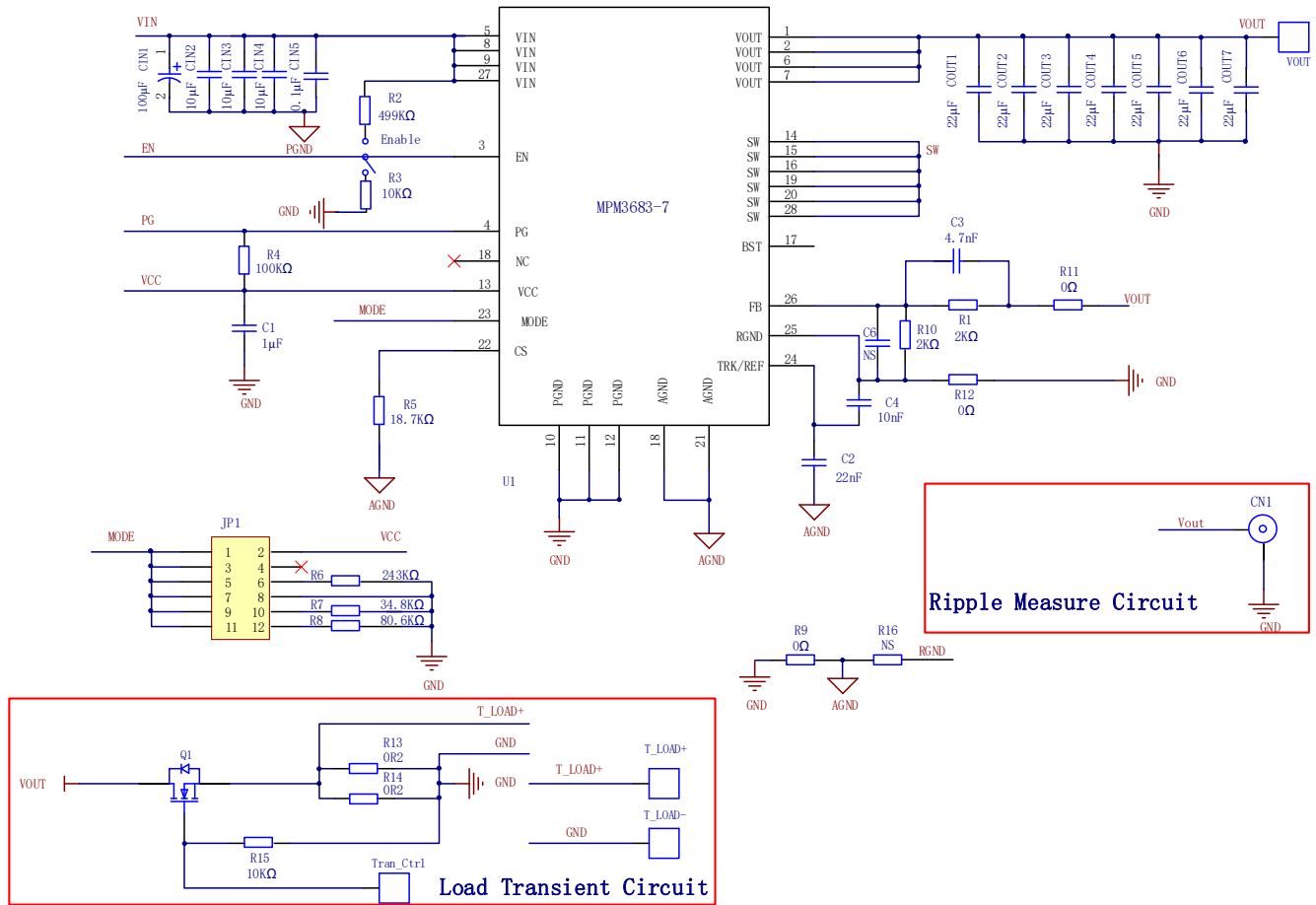

Figure 1: Evaluation Board Schematic

EVM3683-7-QN-01A BILL OF MATERIALS

Qty	Ref	Value	Description	Package	Manufacturer	Manufacturer PN
1	CIN1	100 μ F	Capacitor, 35V	SMD	Nippon Chemi-Con	EMZJ350ADA101 MF80G
3	CIN2, CIN3, CIN4	10 μ F	Ceramic capacitor, 25V, X7S	0805	Murata	GRM21BC71E106 KE11L
1	CIN5	100nF	Ceramic capacitor, 25V, X7R	0603	Murata	GRM188R71E104 KA01D
1	C1	1 μ F	Ceramic capacitor, 25V, X7R	0603	Murata	GRM188R71E105 KA12D
1	C2	22nF	Ceramic capacitor, 25V, X7R	0603	WE	885012206067
1	C3	4.7nF	Ceramic capacitor, 50V, X7R	0603	Murata	GRM188R71H472 KA01D
1	C4	10nF	Ceramic capacitor, 25V, X7R	0603	Murata	GRM188R71E103 KA01D
7	COU1, COU2, COU3, COU4, COU5, COU6, COU7	22 μ F	Ceramic capacitor, 6.3V, X5R	0805	Würth	885012107005
2	R1.R10	2k Ω	Film resistor, 1%	0603	Yageo	RC0603FR-072KL
1	R2	499k Ω	Film resistor, 1%	0603	Yageo	RC0603FR-07499KL
1	R4	100k Ω	Film resistor, 1%	0603	Yageo	RC0603FR-07100KL
2	R3.R15	10k Ω	Film resistor, 1%	0603	Yageo	RC0603FR-0710KL
1	R5	18.7k Ω	Film resistor, 1%	0603	Yageo	RC0603FR-0718K7L
1	R6	243k Ω	Film resistor, 1%	0603	Yageo	RC0603FR-07243KL
1	R7	34.8k Ω	Film resistor, 1%	0603	Yageo	RC0603FR-0734K8L
1	R8	80.6k Ω	Film resistor, 1%	0603	Yageo	RC0603FR-0780K6L
3	R9, R11, R12	0 Ω	Film resistor, 1%	0603	Yageo	RC0603FR-070RL
2	R13, R14	200m Ω	Film resistor, 1%	2512	Yageo	RC2512FR-00R2L
1	Q1	30V	N-channel MOSFET	DFN5X6-8L	Analog Power	AM7432N

EVB TEST RESULTS

$V_{IN} = 12V$, $V_{OUT} = 1.2V$, $T_A = 25^\circ C$, $CCM = 1000k\Omega$, unless otherwise noted.

Efficiency

$V_{IN} = 4V/12V/16V$, $V_{OUT} = 1.2V$,
 $I_{OUT} = 0A$ to $10A$

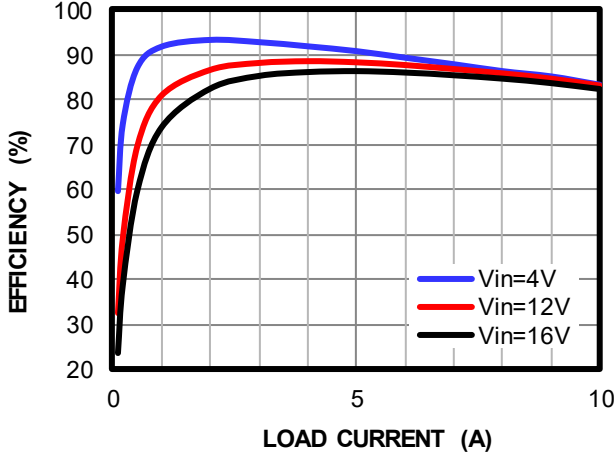

Line Regulation

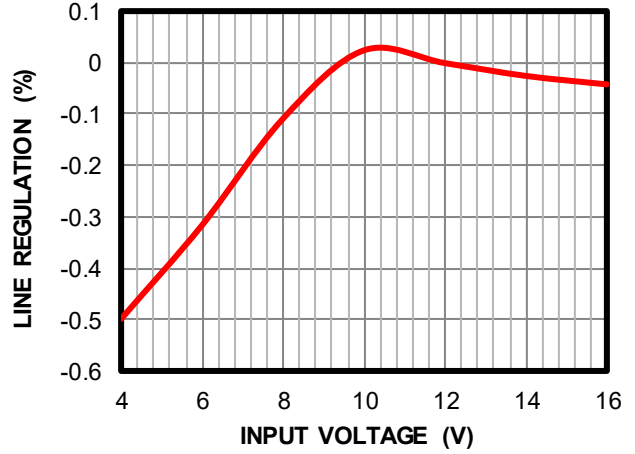

Load Regulation

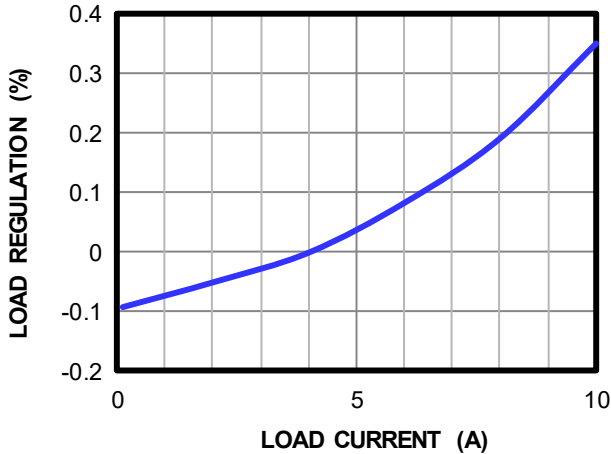

EVB TEST RESULTS *(continued)*

$V_{IN} = 12V$, $V_{OUT} = 1.2V$, $T_A = 25^{\circ}C$, $CCM = 1000k\Omega$, unless otherwise noted.

V_{OUT} Ripple
 $I_{OUT} = 0A$

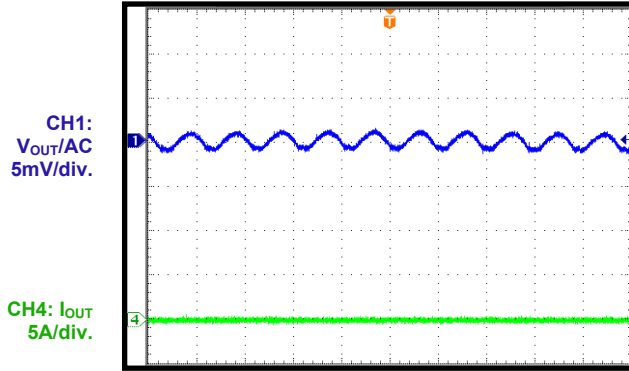

1 μ s/div.

V_{OUT} Ripple
 $I_{OUT} = 10A$

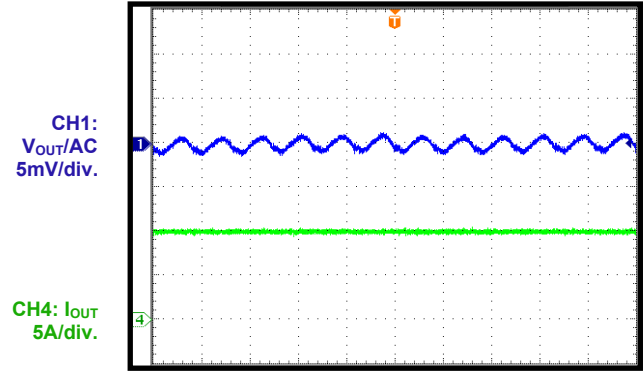

1 μ s/div.

Start-Up through VIN
 $I_{OUT} = 0A$

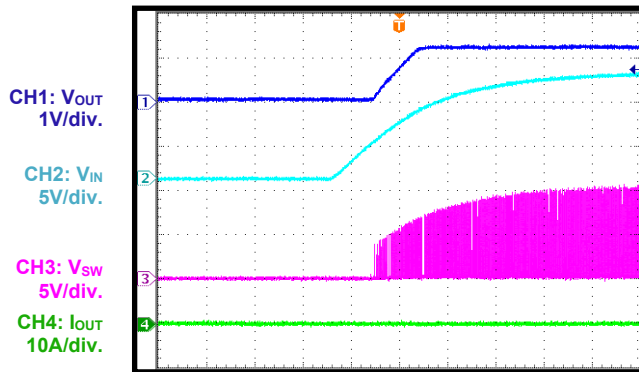

2ms/div.

Start-Up through VIN
 $I_{OUT} = 10A$

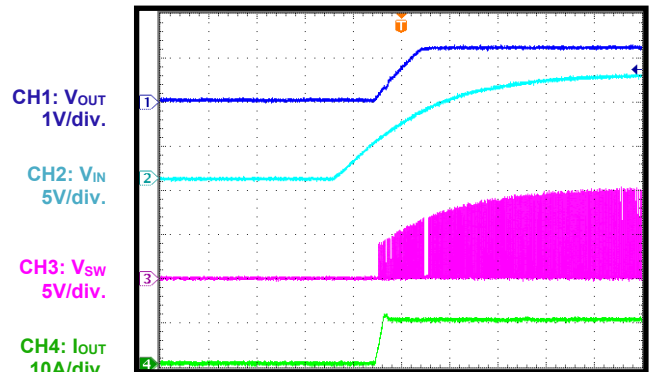

2ms/div.

Shutdown through VIN
 $I_{OUT} = 0A$

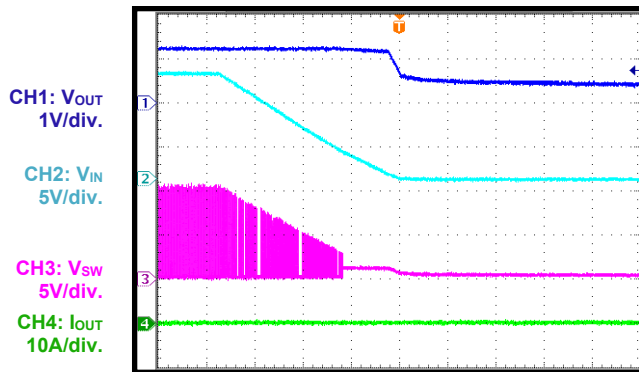

20ms/div.

Shutdown through VIN
 $I_{OUT} = 10A$

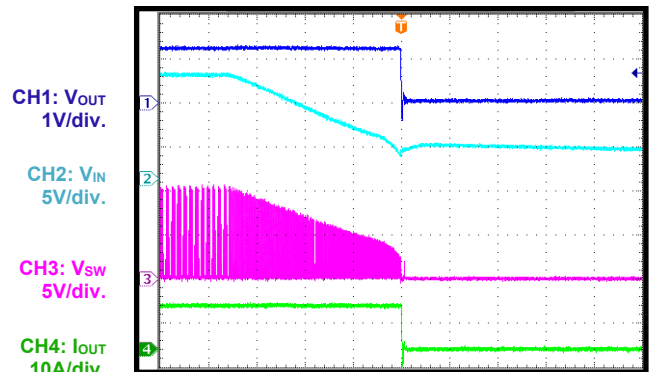

1ms/div.

EVB TEST RESULTS (continued)
 $V_{IN} = 12V$, $V_{OUT} = 1.2V$, $T_A = 25^\circ C$, $CCM = 1000k\Omega$, unless otherwise noted.

Start-Up through EN
 $I_{OUT} = 0A$

CH1: V_{OUT}
1V/div.
R1: V_{PG}
2V/div.
CH2: V_{EN}
5V/div.
CH3: V_{SW}
10V/div.
CH4: I_{OUT}
10A/div.

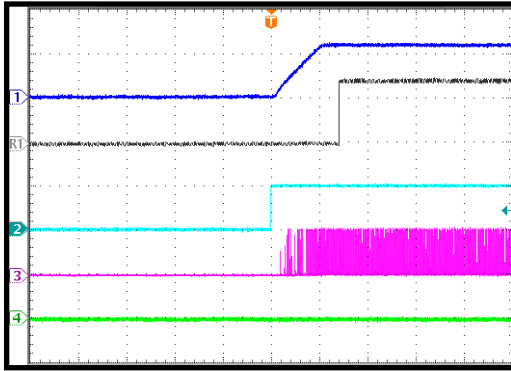

2ms/div.

Start-Up through EN
 $I_{OUT} = 10A$

CH1: V_{OUT}
1V/div.
R1: V_{PG}
2V/div.
CH2: V_{EN}
5V/div.
CH3: V_{SW}
10V/div.
CH4: I_{OUT}
10A/div.

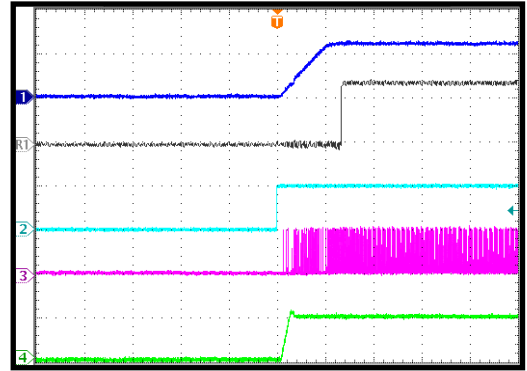

2ms/div.

Shutdown through EN
 $I_{OUT} = 0A$

CH1: V_{OUT}
1V/div.
R1: V_{PG}
2V/div.
CH2: V_{EN}
5V/div.
CH3: V_{SW}
10V/div.
CH4: I_{OUT}
10A/div.

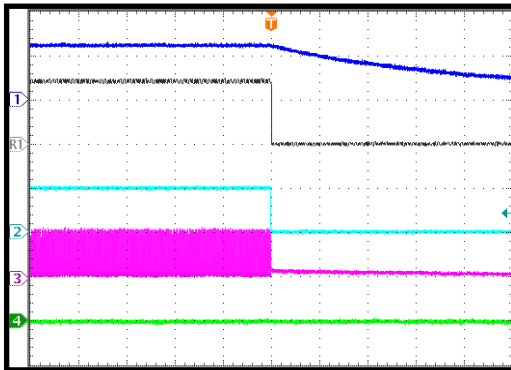

2ms/div.

Shutdown through EN
 $I_{OUT} = 10A$

CH1: V_{OUT}
1V/div.
R1: V_{PG}
2V/div.
CH2: V_{EN}
5V/div.
CH3: V_{SW}
10V/div.
CH4: I_{OUT}
10A/div.

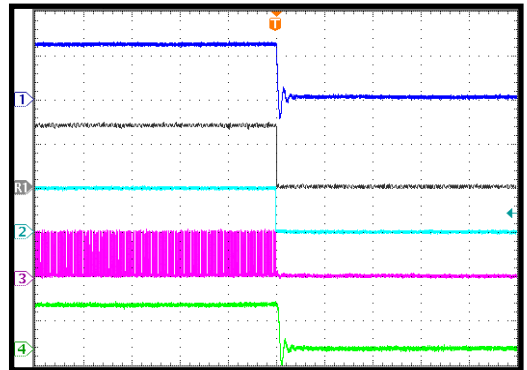

400µs/div.

SCP Recovery
 $I_{OUT} = 0A$

CH1: V_{OUT}
1V/div.
CH2: V_{PG}
2V/div.
CH3: V_{SW}
10V/div.
CH4: I_{OUT}
10A/div.

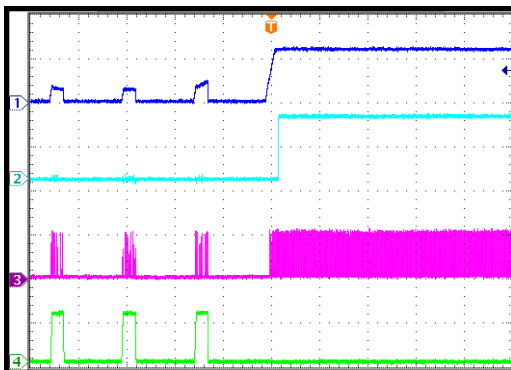

10ms/div.

SCP Recovery
 $I_{OUT} = 10A$

CH1: V_{OUT}
1V/div.
CH2: V_{PG}
2V/div.
CH3: V_{SW}
10V/div.
CH4: I_{OUT}
10A/div.

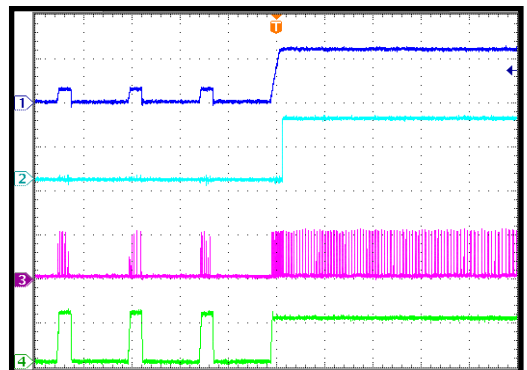

10ms/div.

EVB TEST RESULTS *(continued)*

$V_{IN} = 12V$, $V_{OUT} = 1.2V$, $T_A = 25^{\circ}C$, $CCM = 1000k\Omega$, unless otherwise noted.

SCP Entry

$I_{OUT} = 0A$

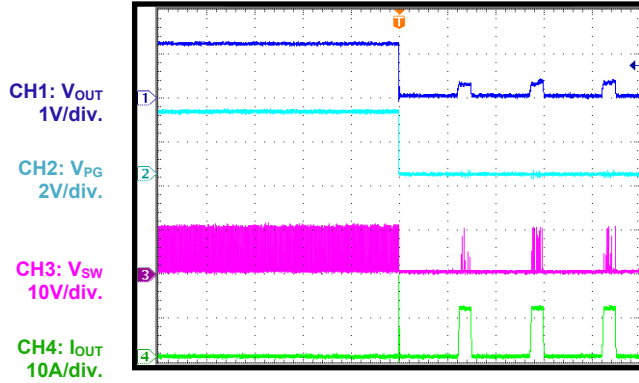

10ms/div.

SCP Entry

$I_{OUT} = 10A$

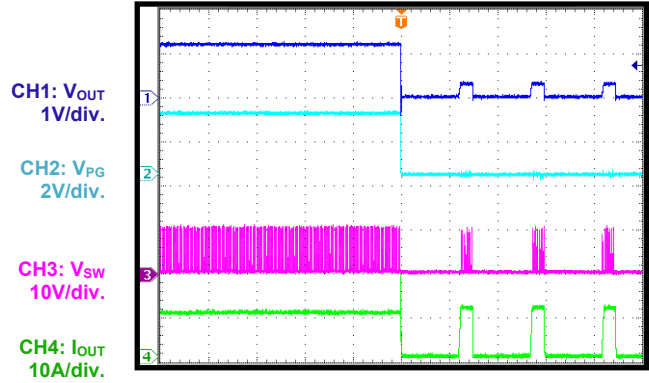

10ms/div.

SCP Steady State

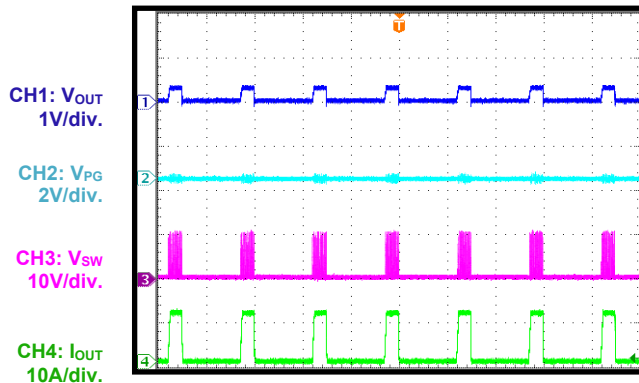

10ms/div.

Load Transient

$I_{OUT} = 5A$ to $10A$, $1A/\mu s$

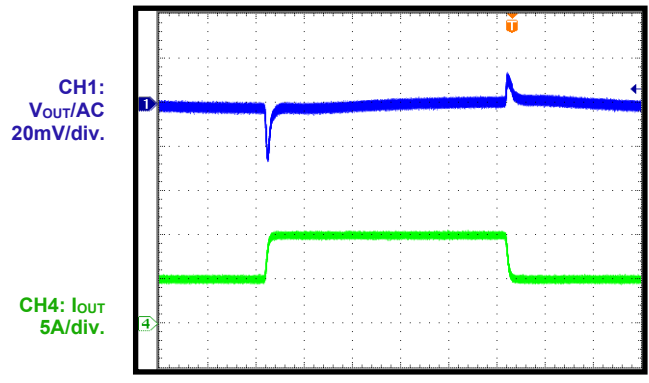

100µs/div.

PCB LAYOUT

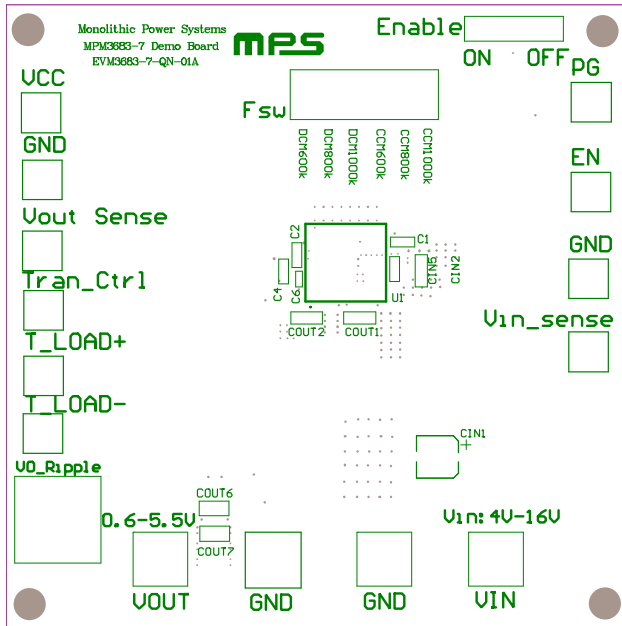

Figure 2: Top Silk

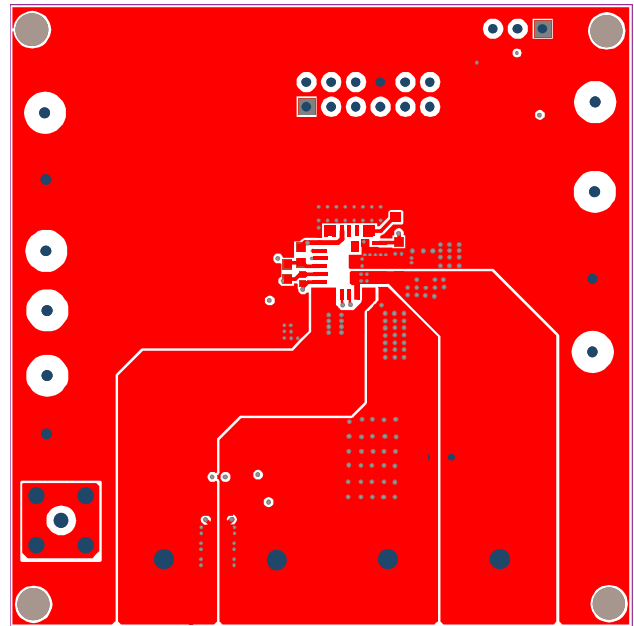

Figure 3: Top Layer

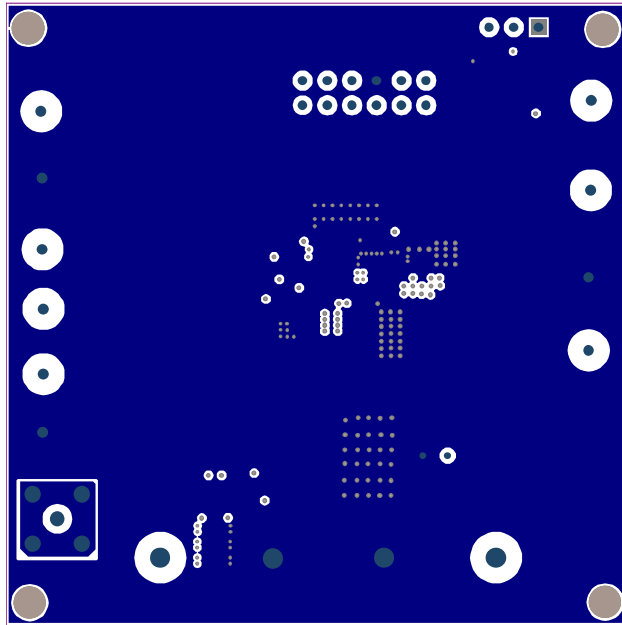

Figure 4: Mid-Layer 1

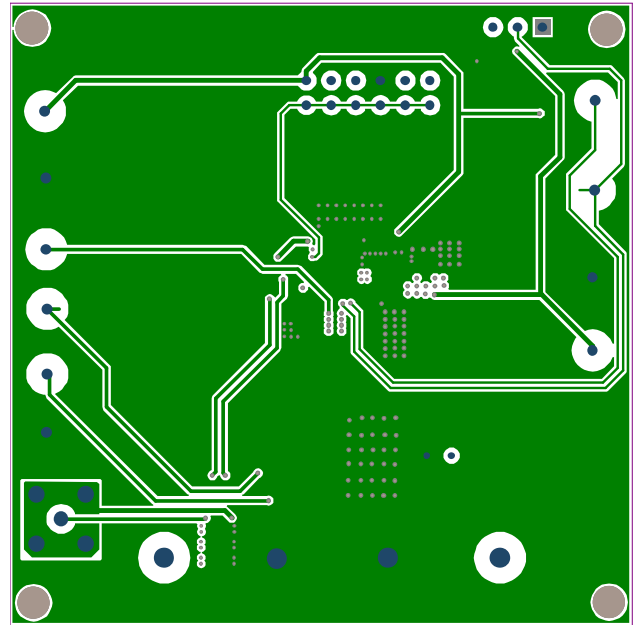

Figure 5: Mid-Layer 2

PCB LAYOUT (continued)

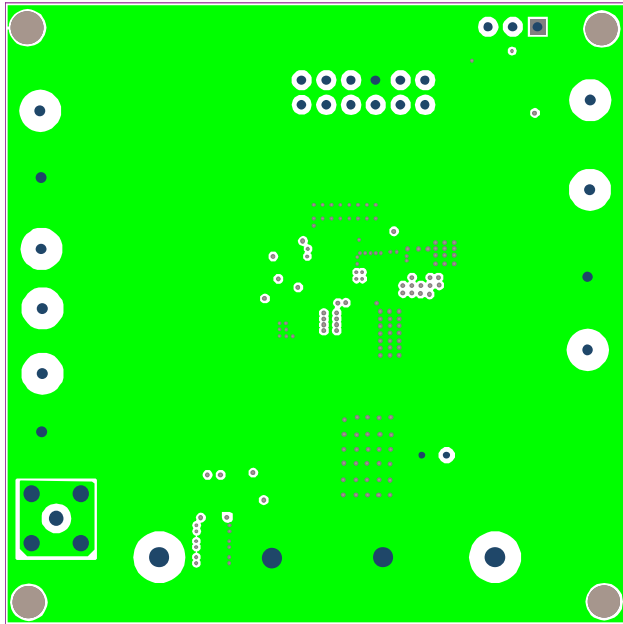

Figure 6: Mid-Layer 3

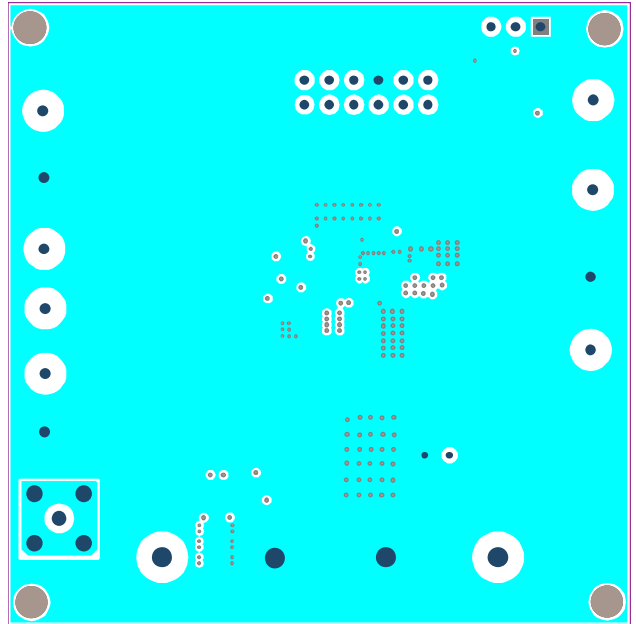

Figure 7: Mid-Layer 4

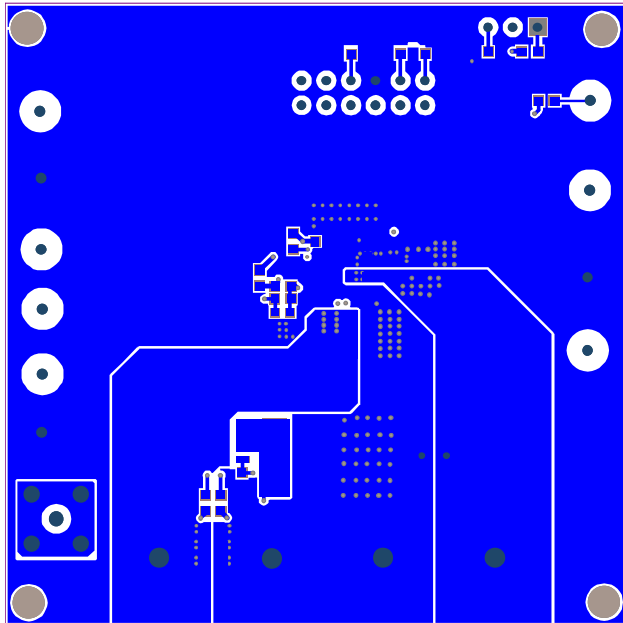

Figure 8: Bottom Layer

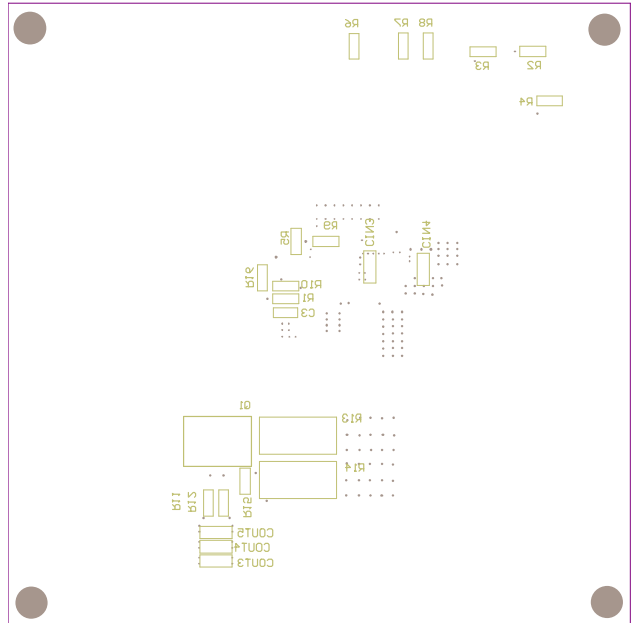

Figure 9: Bottom Silk

REVISION HISTORY

Revision #	Revision Date	Description	Pages Updated
1.0	8/17/2017	Initial Release	-
1.1	3/29/2019	Add the Electrical Specification table; updated the Features section	1
		Updated the Bill of Materials section	3
		Updated the waveforms in the EVB Test Results section	6–8
1.2	6/18/2020	Updated R5 in Figure 1 to 18.7k Ω	3
		Updated the R5 value in the Bill of Materials section to 18.7k Ω	4
1.3	8/26/2022	Updated the footnote below the Applications section; updated EVB image	1
		Moved the position of C6 in Figure 1 to connect FB and RGND	3
		Updated the titles for the Start-Up through VIN, Shutdown through VIN, Start-Up through EN, and Shutdown through EN waveforms in the EVB Test Results section	6–7
		Updated the PCB Layout section	9–10
		Updated the footnote	11
		Grammar and formatting updates; updated pagination; updated figure titles	All

Notice: The information in this document is subject to change without notice. Please contact MPS for current specifications. Users should warrant and guarantee that third-party Intellectual Property rights are not infringed upon when integrating MPS products into any application. MPS will not assume any legal responsibility for any said applications.