

DATA SHEET

SKY12245-492LF: 0.3 to 5.0 GHz, 100 W Compact High-Power SPDT Switch with Integrated Driver

Applications

- TDD 3G/4G/5G systems
- High-power switch for micro cell base stations and macro cell base stations
- Active antenna array

Features

- Compact, integrated high-power switch with driver circuit
- Small PCB footprint with minimal external components
- Requires only a single +5 V DC supply, and a 0 to 3 V logic control
- Low TX/RX insertion loss
- High TX to RX isolation
- Low DC power consumption: <130 mA in TX or RX mode
- Small QFN (20-pin, 5 × 5 mm) Pb-free package (MSL3, 260 °C per JEDEC J-STD-020)



Skyworks Green™ products are compliant with all applicable legislation and are halogen-free. For additional information, refer to *Skyworks Definition of Green™*, document number SQ04-0074.

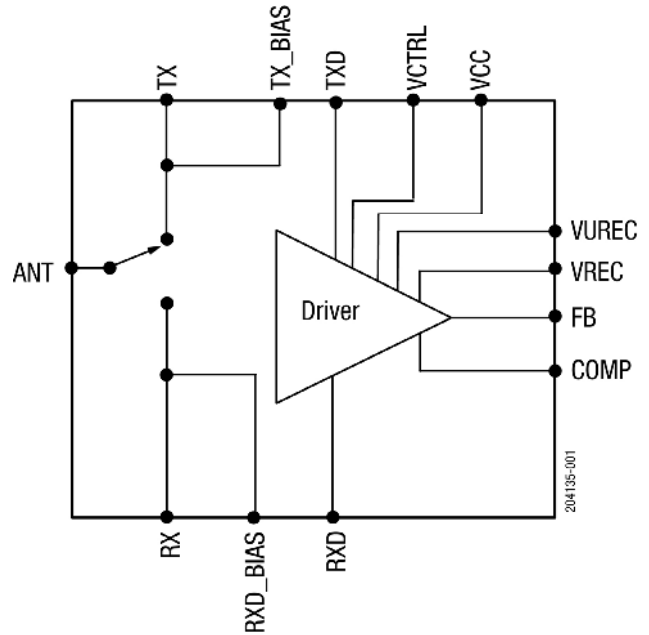

Figure 1. SKY12245-492LF Block Diagram

Description

The SKY12245-492LF is a compact, integrated high-power single-pole, double-throw (SPDT) PIN diode switch with driver circuit for TDD-LTE and similar applications. The part operates with a single +5 V supply and switches with a single control voltage (0 to 3 V). It can be tuned to specific RF bands within the range of 0.3 to 5.0 GHz by modifying select external SMT components.

This device features low TX and RX insertion loss, high isolation with low DC power consumption and requires minimal external components, enabling a smaller PCB footprint.

The device is provided in a 5 × 5 mm, 20-pin Quad Flat No-Lead (QFN) package. A functional block diagram is shown in Figure 1. The pin configuration and package are shown in Figure 2. Signal pin assignments and functional pin descriptions are provided in Table 1.

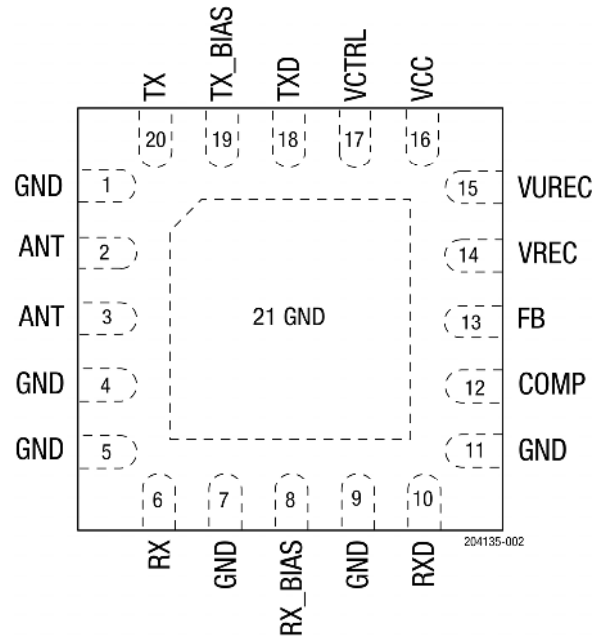

Figure 2. SKY12245-492LF Pinout (Top View)

Table 1. SKY12245-492LF Signal Pin Descriptions

Pin	Name	Function	Description
1, 4, 5, 7, 9, 11	GND	Ground	Ground. Must be connected to ground using lowest possible impedance.
2, 3	ANT	I/O	Antenna RF port and DC bias input port. RF input line must be connected to both pins.
6	RX	O	Receive RF output port and DC bias input port.
8	RX_BIAS	I	DC bias input port.
10	RXD	O	Driver output voltage for switch RX port.
12	COMP	O	Compensation pin of the internal boost converter.
13	FB	O	Feedback pin of the internal boost converter.
14	VREC	I	Rectified output voltage node of the internal boost converter.
15	VUREC	O	Unrectified output voltage node of the internal boost converter.
16	VCC	I	Input voltage for driver Vcc.
17	VCTRL	I	Switch control (0/3 V) (0 V for Receive mode, 3 V for Transmit mode).
18	TXD	O	Driver output pin for TX port DC bias connection.
19	TX_BIAS	I	DC bias input port.
20	TX	I	Transmit RF input port and DC bias input port.
21	GND	Ground	Ground.

Electrical and Mechanical Specifications

The absolute maximum ratings of the SKY12245-492LF are provided in Table 3. Recommended operating conditions are specified in Table 4, and DC characteristics are shown in Table 5. Electrical specifications are provided in Table 6.

The state of the SKY12245-492LF is determined by the logic provided in Table 7.

Typical performance characteristics of the SKY12245-492LF are illustrated in Figures 3 through 22. Power derating data is plotted against temperature in Figure 23.

Table 3. SKY12245-492LF Absolute Maximum Ratings¹
(T_c = 25 °C, Unless Otherwise Noted)

Parameter	Symbol	Minimum	Maximum	Units
RF CW input power, ANT and TX ports, TX mode (T _c = 85 °C)	P _{IN}		91	W
RF peak input power, ANT and TX ports, TX mode (T _c = 85 °C, LTE-TDD, DC = 88%, 91 W average power, 8 dB PAR)	P _{IN}		575	W
RF CW input power, ANT port, RX mode (T _c = 85 °C)	P _{IN}		5	W
RF peak input power, ANT port, RX mode (T _c = 85 °C, LTE-TDD, DC = 88%, 5 W average power, 8 dB PAR)	P _{IN}		32	W
RF peak input power, ANT and TX ports, TX mode, Band 41 (2496 MHz to 2690 MHz) for 30 seconds (T _c = 105 °C, LTE-TDD, DC = 88%, 100 W average power, 8 dB PAR)	P _{IN}		631	W
Module supply voltage	V _{CC}		6	V
Logic control voltage	V _{CTL}	-0.5	+5.5	V
Operating temperature range	T _c	-40	+105	°C
Storage temperature range	T _{STG}	-55	+150	°C
Maximum junction temperature:	T _J			
Diodes			+175	°C
Driver			+140	°C
Thermal resistance: ²	θ _{JC}			
TX diode (T _c = 85 °C)			14.8	°C/W
CMOS driver			10	°C/W
LTE (PAR = 8 dB DC = 88%)			10.5	°C/W
Electrostatic discharge:	ESD			
Charged-Device Model (CDM), Class C3			1000	V
Human Body Model (HBM), Class 1B			500	V

¹ Exposure to maximum rating conditions for extended periods may reduce device reliability. There is no damage to device with only one parameter set at the limit and all other parameters set at or below their nominal value. Exceeding any of the limits listed here may result in permanent damage to the device.

² Power derating curve for complete circuit, which includes PIN diodes and CMOS driver is shown in Figure 23.

ESD HANDLING: Although this device is designed to be as robust as possible, electrostatic discharge (ESD) can damage this device. This device must be protected at all times from ESD when handling or transporting. Static charges may easily produce potentials of several kilovolts on the human body or equipment, which can discharge without detection. Industry-standard ESD handling precautions should be used at all times.

Table 4. SKY12245-492LF Recommended Operating Conditions

Parameter	Symbol	Min	Typ	Max	Units
Module supply voltage	V _{CC}	4.5	5	5.5	V
Logic control voltage (low)	V _{CTL_L}	0	0	0.4	V
Logic control voltage (high)	V _{CTL_H}	1.2	3	V _{CC}	V

Table 5. SKY12245-492LF DC Electrical Characteristics

Parameter	Symbol	Min	Typ	Max	Units
Driver supply current TX Mode: For BoMs 1, 2, 3, and 5 For BoM 4	l _{cc_TX}		129 104	175 150	mA mA
Driver supply current RX Mode: For BoMs 1, 2, 3, and 5 For BoM 4	l _{cc_RX}		84 77	110 100	mA mA

Table 6. SKY12245-492LF Electrical Specifications¹ (1 of 4)

(T_c = +25 °C, Characteristic Impedance [Z₀] = 50 Ω, as Measured on the Evaluation Board Using BoM Number 1, 2, 3, 4, or 5. Unused Port Terminated to 50 Ω)

Parameter	Symbol	Test Condition	BoM	Min	Typ	Max	Units
Insertion loss, TX to ANT ports	IL _{TX-ANT}	V _{CC} = 5 V, V _{CTRL} = 3 V (TX mode), TX port input power (pin 20) = 0 dBm, measured at TX port:					
		0.5 GHz	1		0.1		dB
		2.4 GHz	2		0.2		dB
		3.6 GHz	3		0.25	0.5	dB
		4.1 GHz	4		0.4		dB
4.6 GHz ²	5		0.4	0.7	dB		
Insertion loss, ANT to RX ports	IL _{ANT-RX}	V _{CC} = 5 V, V _{CTRL} = 0 V (RX mode), ANT port input power (pins 2, 3) = 0 dBm, measured at RX port:					
		0.5 GHz	1		0.1		dB
		2.4 GHz	2		0.3		dB
		3.6 GHz	3		0.35	0.6	dB
		4.1 GHz	4		0.55		dB
4.6 GHz ²	5		0.7	1.0	dB		
Isolation, TX to RX ports	ISO _{TX-RX}	V _{CC} = 5 V, V _{CTRL} = 3 V (TX mode), TX port input power (pin 20) = 0 dBm measured at RX port:					
		0.5 GHz	1		46		dB
		2.4 GHz	2		45		dB
		3.6 GHz	3	41	43		dB
		4.1 GHz	4		43		dB
4.6 GHz ²	5	36	41		dB		
Isolation, ANT to TX ports	ISO _{ANT-TX}	V _{CC} = 5 V, V _{CTRL} = 0 V (RX mode), ANT port input power (pin 3) = 0 dBm, measured at TX port:					
		0.5 GHz	1		25		dB
		2.4 GHz	2		25		dB
		3.6 GHz	3	24	28		dB
		4.1 GHz	4		23		dB
4.6 GHz ²	5	12	17		dB		
Isolation, ANT to RX ports	ISO _{ANT-RX}	V _{CC} = 5 V, V _{CTRL} = 3 V (TX mode), ANT port input power (pins 2, 3) = 0 dBm, measured at RX port:					
		0.5 GHz	1		45		dB
		2.4 GHz	2		46		dB
		3.6 GHz	3	37	39		dB
		4.1 GHz	4		38		dB
4.6 GHz ²	5	30	35		dB		
TX input return loss	TX _{RL}	TX insertion loss state, TX port (pin 20) V _{CC} = 5 V, V _{CTRL} = 3 V:					
		0.5 GHz	1		31		dB
		2.4 GHz	2		37		dB
		3.6 GHz	3	15	19		dB
		4.1 GHz	4		19		dB
4.6 GHz ²	5	12	18		dB		

Table 6. SKY12245-492LF Electrical Specifications¹ (2 of 4)

(Tc = +25 °C, Characteristic Impedance [Zo] = 50 Ω, as Measured on the Evaluation Board Using BoM Number 1, 2, 3, 4, or 5. Unused Port Terminated to 50 Ω)

Parameter	Symbol	Test Condition	BoM	Min	Typ	Max	Units
RX input return loss	RX_RL	RX insertion loss state, ANT port (pins 2, 3) Vcc = 5 V, VCTRL = 0 V:					
		0.5 GHz	1		38		dB
		2.4 GHz	2		30		dB
		3.6 GHz	3	15	20		dB
		4.1 GHz	4		21		dB
4.6 GHz ²	5	12	18		dB		
Transmit 2 nd harmonic	2fo	TX insertion loss state, TX port (pin 20) input power = +30 dBm, Vcc = 5 V, VCTRL = 3 V:					
		0.5 GHz	1		+70		dBc
		2.4 GHz	2		+68		dBc
		3.6 GHz	3		+68		dBc
		4.1 GHz	4		+68		dBc
4.6 GHz	5		+68		dBc		
Transmit 3 rd harmonic	3fo	TX insertion loss state, TX port input power (pin 20) = +30 dBm, Vcc = 5 V, VCTRL = 3 V:					
		0.5 GHz	1		+83		dBc
		2.4 GHz	2		+89		dBc
		3.6 GHz	3		+86		dBc
		4.1 GHz	4		+86		dBc
4.6 GHz	5		+86		dBc		
Transmit input third order intercept point	IIP3	TX port input power (pin 20) = +30 dBm/tone, tone spacing = 1 MHz, Vcc = 5 V, VCTRL = 3 V:					
		0.5 GHz	1		+68		dBm
		2.4 GHz	2		+71		dBm
		3.6 GHz	3		+69		dBm
		4.1 GHz	4		+69		dBm
4.6 GHz	5		+69		dBm		
Transmit input power for 0.1 dB compression	PIN_TX_IP0.1dB	Vcc = 5 V, VCTRL = 3 V:					
		0.5 GHz	1		+50		dBm
		2.4 GHz	2		+49		dBm
		3.6 GHz	3		+48		dBm
		4.1 GHz	4		+48		dBm
4.6 GHz	5		+48		dBm		
Receive input power for 0.1 dB compression	PIN_RX_IP0.1dB	Vcc = 5 V, VCTRL = 0 V:					
		0.5 GHz	1		+38		dBm
		2.4 GHz	2		+38		dBm
		3.6 GHz	3		+38		dBm
		4.1 GHz	4		+38		dBm
4.6 GHz	5		+38		dBm		
Maximum transmit CW input power	PIN_TX_MAX	Vcc = 5 V, VCTRL = 3 V			100		W
Maximum receive CW input power	PIN_RX_MAX	Vcc = 5 V, VCTRL = 0 V			6		W
Transmit RF rise time	tr_TX	TX mode; 10% RF power to 90% RF power at ANT output, Vcc = 5 V, VCTRL = 0 to 3 V:					
		0.5 GHz	1		264		ns
		2.4 GHz	2		193		ns
		3.6 GHz	3		429		ns
		4.1 GHz	4		400		ns
4.6 GHz	5		430		ns		

Table 6. SKY12245-492LF Electrical Specifications¹ (3 of 4)
 (Tc = +25 °C, Characteristic Impedance [Zo] = 50 Ω, as Measured on the Evaluation Board Using BoM Number 1, 2, 3, 4, or 5. Unused Port Terminated to 50 Ω)

Parameter	Symbol	Test Condition	BoM	Min	Typ	Max	Units
Transmit RF fall time	tF_TX	TX mode; 90% RF power to 10% RF power at ANT output, Vcc = 5 V, VCTRL = 3 to 0 V: 0.5 GHz 2.4 GHz 3.6 GHz 4.1 GHz 4.6 GHz	1		92		ns
			2		200		ns
			3		288		ns
			4		300		ns
			5		305		ns
Transmit RF switch on time	tON_TX	TX mode; 50% VCTRL signal to 90% RF power at ANT output port, Vcc = 5 V, VCTRL = 0 to 3 V: 0.5 GHz 2.4 GHz 3.6 GHz 4.1 GHz 4.6 GHz ²	1		521		ns
			2		431		ns
			3		678		ns
			4		650		ns
			5		675	1155	ns
Transmit RF switch off time	tOFF_TX	TX mode; 90% RF power to 50% VCTRL signal at TX output port, Vcc = 5 V, VCTRL = 3 to 0 V: 0.5 GHz 2.4 GHz 3.6 GHz 4.1 GHz 4.6 GHz ²	1		530		ns
			2		289		ns
			3		389		ns
			4		400		ns
			5		405	600	ns
Receive RF rise time	tR_RX	RX mode; 10% RF power to 90% RF power at RX output, Vcc = 5 V, VCTRL = 3 to 0 V: 0.5 GHz 2.4 GHz 3.6 GHz 4.1 GHz 4.6 GHz	1		572		ns
			2		565		ns
			3		570		ns
			4		600		ns
			5		600		ns
Receive RF fall time	tF_RX	RX mode; 90% RF power to 10% RF power at RX output, Vcc = 5 V, VCTRL = 0 to 3 V: 0.5 GHz 2.4 GHz 3.6 GHz 4.1 GHz 4.6 GHz	1		70		ns
			2		24		ns
			3		16		ns
			4		50		ns
			5		55		ns
Receive RF switch on time	tON_RX	RX mode; 50% VCTRL signal to 90% RF power at RX output port, Vcc = 5 V, VCTRL = 3 to 0 V: 0.5 GHz 2.4 GHz 3.6 GHz 4.1 GHz 4.6 GHz ²	1		1207		ns
			2		1168		ns
			3		1806		ns
			4		1800		ns
			5		1800	2400	ns

Table 6. SKY12245-492LF Electrical Specifications¹ (4 of 4)
 (Tc = +25 °C, Characteristic Impedance [Zo] = 50 Ω, as Measured on the Evaluation Board Using BoM Number 1, 2, 3, 4, or 5. Unused Port Terminated to 50 Ω)

Parameter	Symbol	Test Condition	BoM	Min	Typ	Max	Units
Receive RF switch off time	toff_RX	RX mode; 90% RF power to 50% VCTRL signal at RX output port, Vcc = 5 V, VCTRL = 0 to 3 V:					
		0.5 GHz	1		369		ns
		2.4 GHz	2		153		ns
		3.6 GHz	3		144		ns
		4.1 GHz	4		200		ns
4.6 GHz ²	5		205	400	ns		
ANT to TX gain settling time	ts_TX	TX mode gain settling time within 0.3 dB of final value after T/R command, PIN = 0 dBm, CW, VCTRL = 0 to 3 V, DC = 50%, pulse rate = 1 KHz:					
		0.5 GHz	1		0.8		μs
		2.4 GHz	2		0.8		μs
		3.6 GHz	3		0.7		μs
		4.1 GHz	4		0.8		μs
4.6 GHz	5		0.8		μs		
ANT to RX gain settling time	ts_RX	RX mode gain settling time within 0.3 dB of final value after T/R command, PIN = 0 dBm, CW, VCTRL = 3 to 0 V, DC = 50%, pulse rate = 1 KHz:					
		0.5 GHz	1		1.4		μs
		2.4 GHz	2		1.9		μs
		3.6 GHz	3		1.9		μs
		4.1 GHz	4		1.9		μs
4.6 GHz	5		1.9		μs		

¹ Performance is guaranteed only under the conditions listed in this table.

² Not tested in production. Guaranteed by design.

Table 7. SKY12245-492LF Truth Table (Voltages and Currents Are Controlled by Internal Driver Circuit. Vcc = 5 V)

Switch State	Path		Control Conditions					
	Antenna-to-Receiver Port (Pin 2/3 to Pin 6)	Transmitter-to-Antenna Port (Pin 20 to Pin 2/3)	Logic Control VCTRL (Pin 17)	Antenna Port Bias Input (Pins 2/3)	Transmitter Port Bias Input (Pin 20)	Receiver Port Bias Input (Pin 6)	RX_BIAS Bias Input (Pin 8)	TX_BIAS Bias Input (Pin 19)
Receive mode	Low insertion loss	High isolation	0 V	1 V	5 V	0 V	5 V	4 V
Transmit mode	High isolation	Low insertion loss	3 V	1 V	0 V	16 V	15 V	16 V

Typical Performance Characteristics

(Tc = +25 °C, Characteristic Impedance [Zo] = 50 Ω, EVB Optimized for 0.3 to 1.0 GHz Operation, Using BoM 1. Unused Port Terminated to 50 Ω)

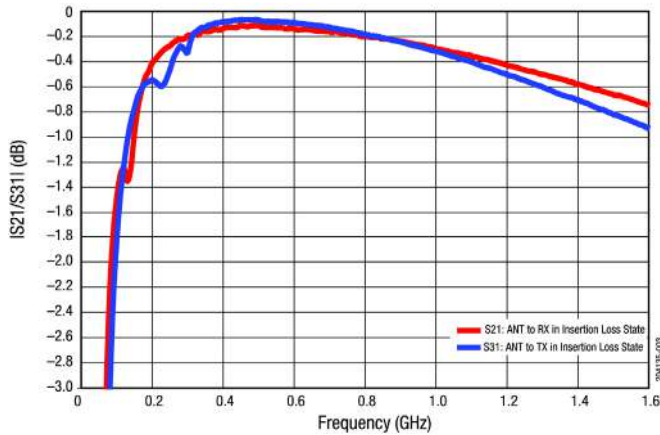

Figure 3. Insertion Loss vs Frequency

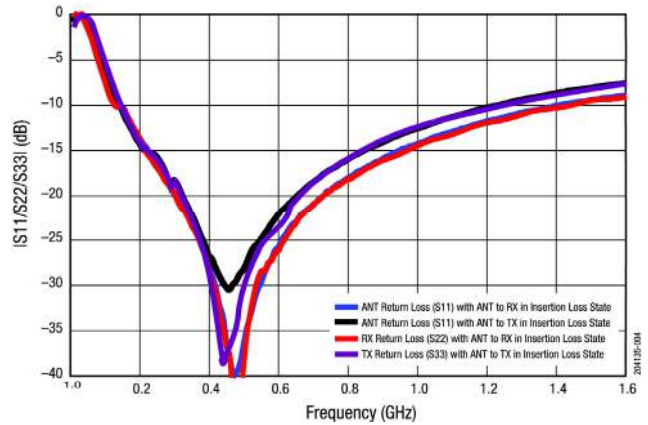

Figure 4. Return Loss Frequency

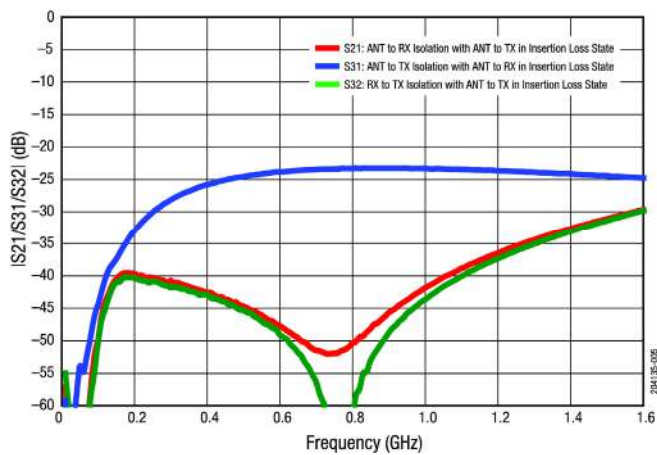

Figure 5. Isolation vs Frequency

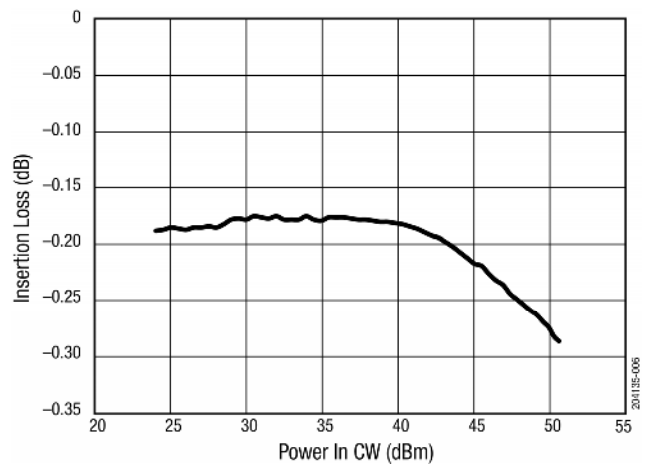

Figure 6. Insertion Loss vs CW Input Power (ANT to TX Port, f = 0.5 GHz)

Typical Performance Characteristics

(Tc = +25 °C, Characteristic Impedance [Zo] = 50 Ω, EVB Optimized for 2.0 to 2.8 GHz Operation, Using BoM 2. Unused Port Terminated to 50 Ω)

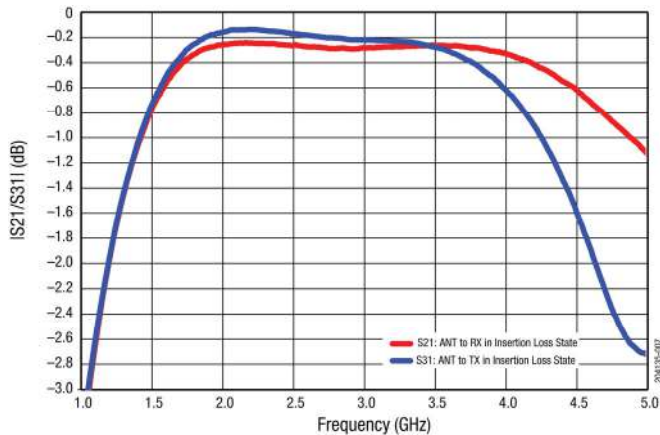

Figure 7. Insertion Loss vs Frequency

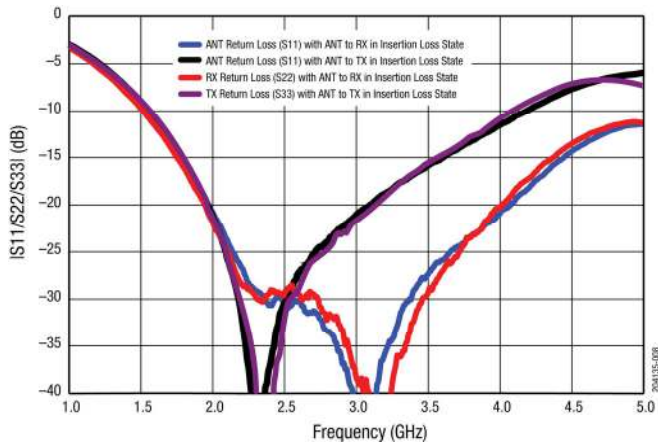

Figure 8. Return Loss vs Frequency

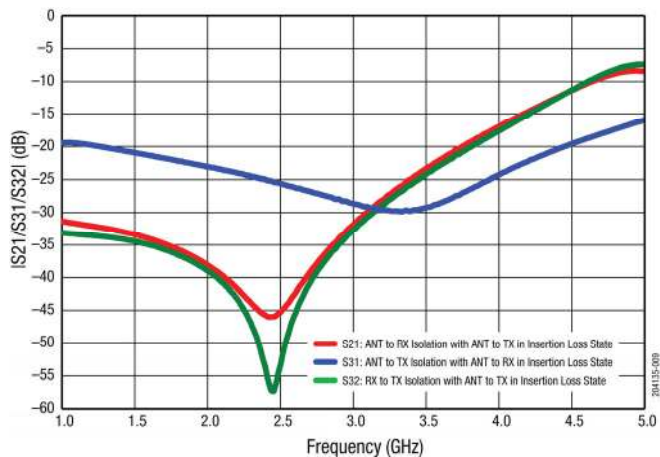

Figure 9. Isolation vs Frequency

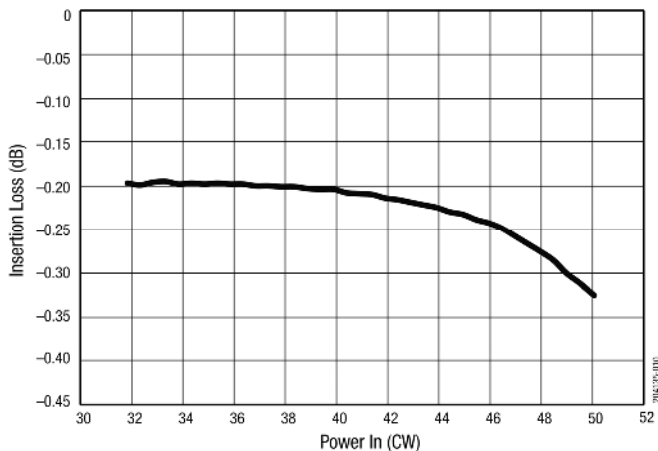

Figure 10. Insertion Loss vs CW Input Power (ANT to TX Port, f = 2.4 GHz)

Typical Performance Characteristics

(Tc = +25 °C, Characteristic Impedance [Zo] = 50 Ω, EVB Optimized for 3.4 to 3.8 GHz Operation, Using BoM 3. Unused Port Terminated to 50 Ω)

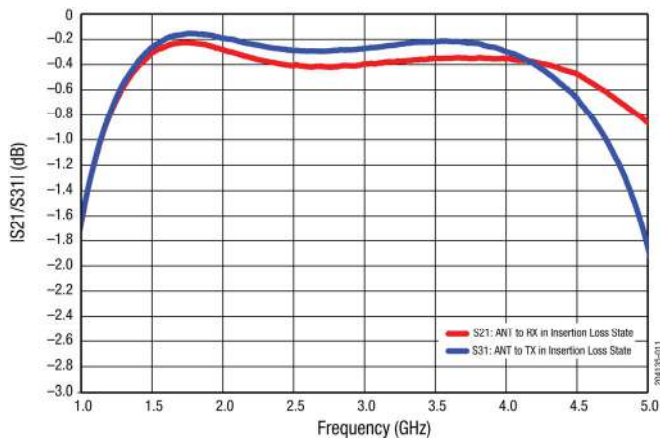

Figure 11. Insertion Loss vs Frequency

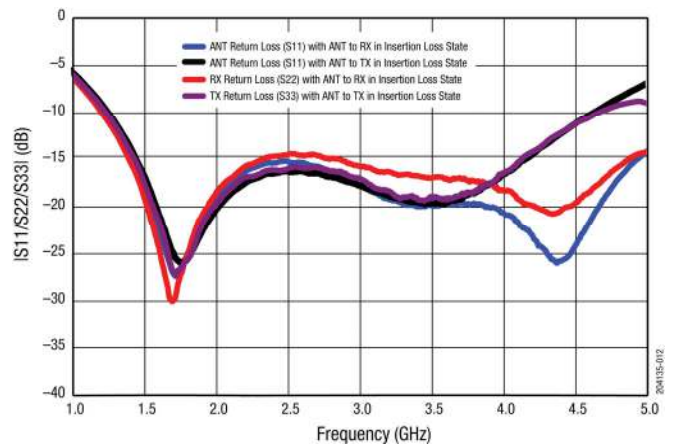

Figure 12. Return Loss vs Frequency

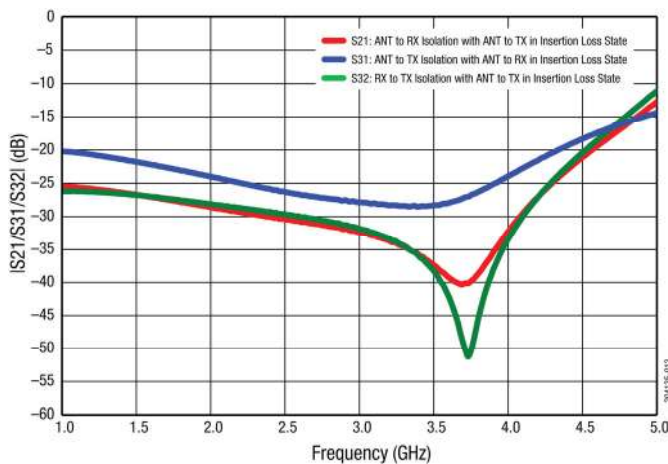

Figure 13. Isolation vs Frequency

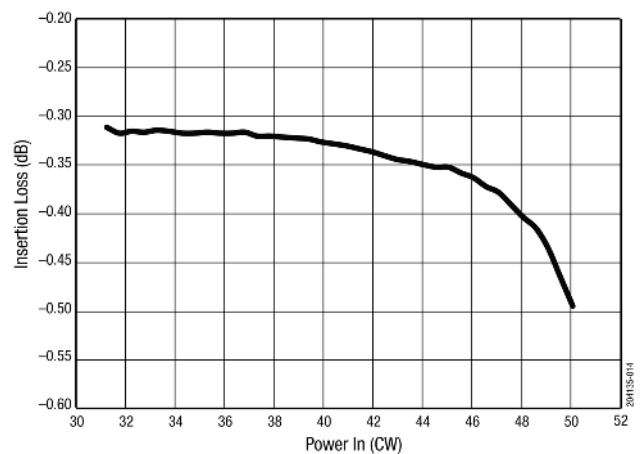

Figure 14. Insertion Loss vs CW Input Power (ANT to TX Port, f = 3.6 GHz)

Typical Performance Characteristics

(Tc = +25 °C, Characteristic Impedance [Zo] = 50 Ω, EVB Optimized for 3.3 to 4.2 GHz Operation, Using BoM 4. Unused Port Terminated to 50 Ω)

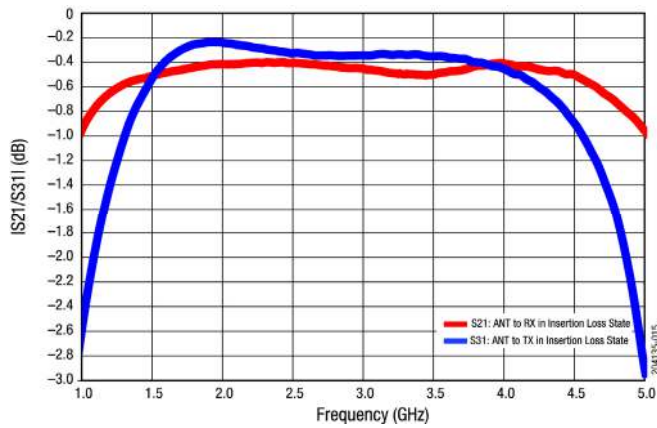

Figure 15. Insertion Loss vs Frequency

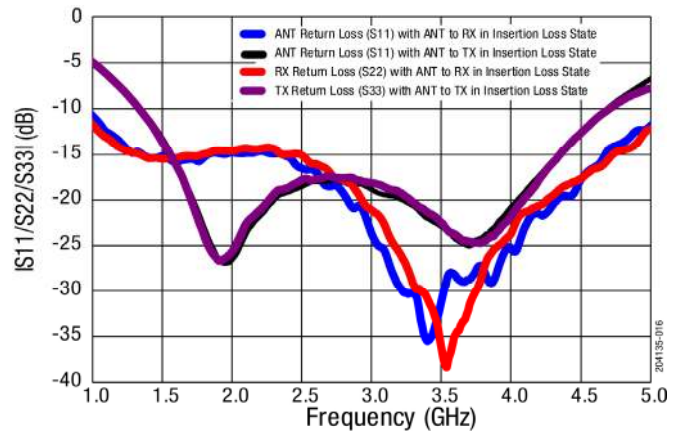

Figure 16. Return Loss vs Frequency

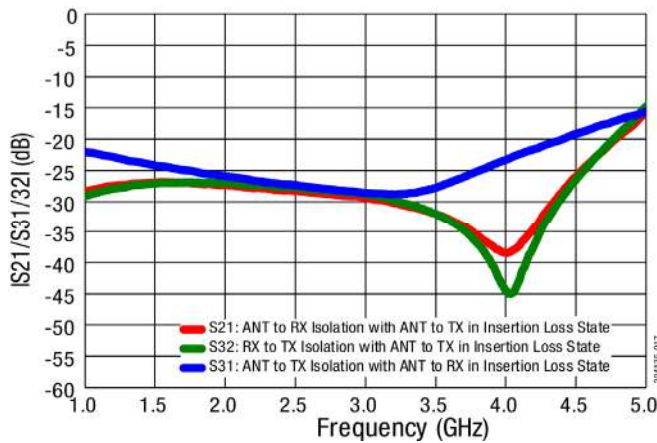

Figure 17. Isolation vs Frequency

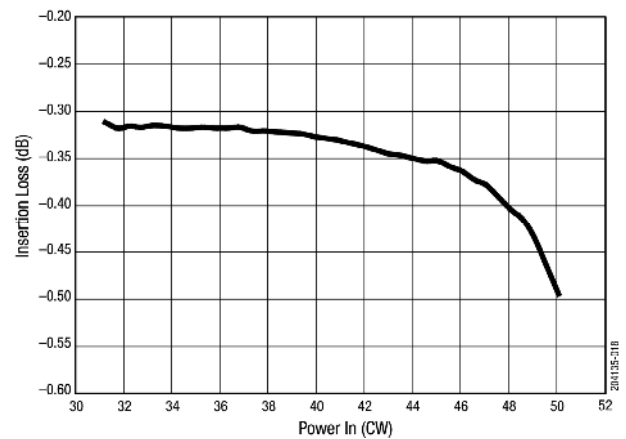

Figure 18. Insertion Loss vs CW Input Power (ANT to TX Port, f = 3.6 GHz)

Typical Performance Characteristics

(Tc = +25 °C, Characteristic Impedance [Zo] = 50 Ω, EVB Optimized for 4.4 to 4.6 GHz Operation, Using BoM 5. Unused Port Terminated to 50 Ω)

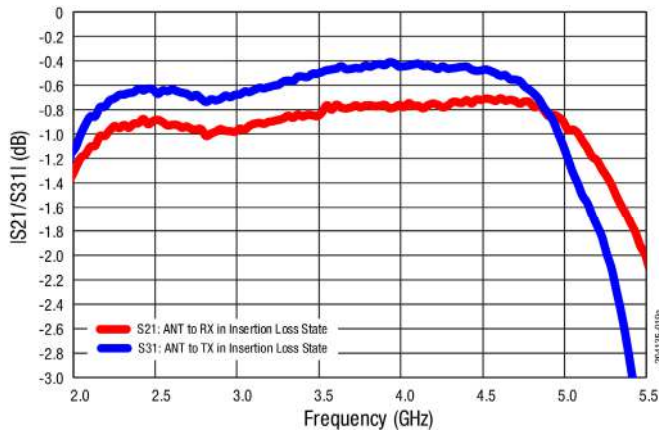

Figure 19. Insertion Loss vs Frequency

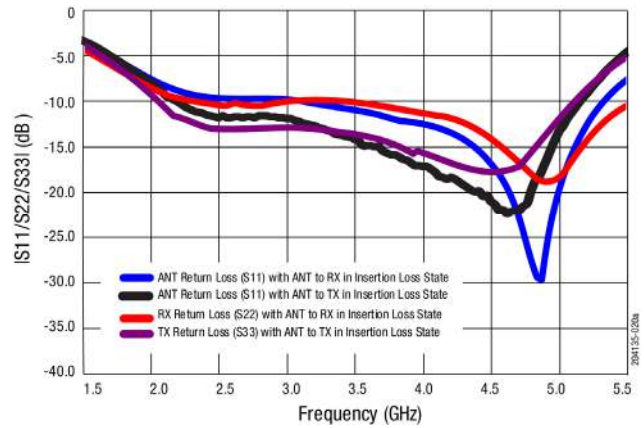

Figure 20. Return Loss vs Frequency

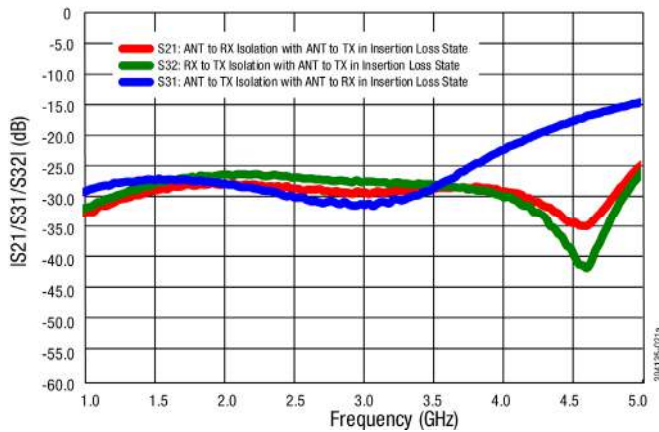

Figure 21. Isolation vs Frequency

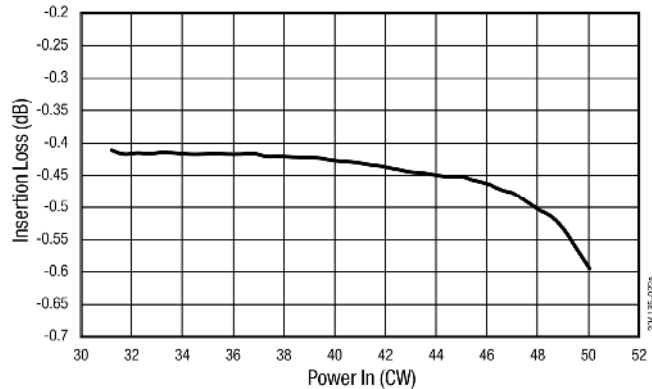

Figure 22. Insertion Loss vs CW Input Power (ANT to TX Port, f = 4.6 GHz)

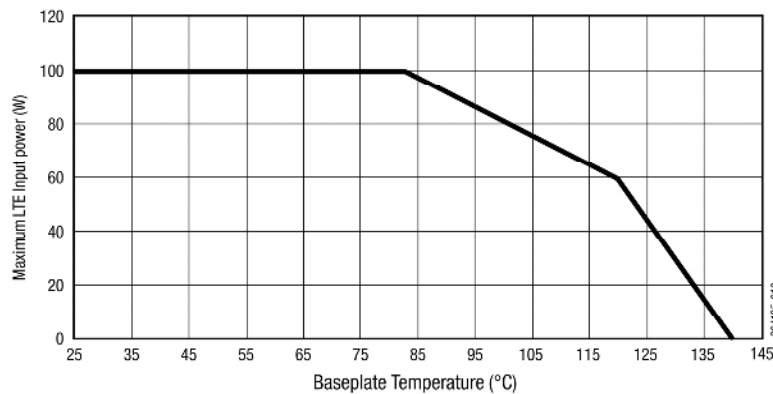

Figure 23. Transmit Power Derating, Maximum LTE Signal Power vs Baseplate Temperature (0.3 dB Insertion Loss)

Evaluation Board Description

The SKY12245-492LF Evaluation Board is used to test the performance of the SKY12245-492LF high-power SPDT switch.

The SKY12245-492LF is designed to handle very large signals. Sufficient power may be dissipated by this switch to cause heating of the PIN diodes contained in the switch. It is very important to use a printed circuit board design that provides adequate grounding to facilitate thermal conduction allowing the PIN diodes to remain below their maximum rated junction temperature.

The evaluation circuit is designed to facilitate control of the SKY12245-492LF transmit/receive switch with a single TTL input. The state of the PIN diodes within the SKY12245-492LF with integrated driver is controlled with 5 V applied to the VCC pin and either 3 V or 0 V applied to the VCTRL pin.

The internal driver manages the voltages applied to the TX and RX ports to determine whether the RX or TX series diodes are biased into forward conduction. For example, with 3 V applied to VCTRL, the driver places the SKY12245-492LF into the transmit state by directing 0 V to the TX port (which forward-biases the diode between pins 2, 3, and 20) and 16 V is applied to the RX port (which reverse-biases the diode between pins 2, 3, and 6).

In this data sheet, the switch external components were selected to optimize performance in four different RF bands: 0.3 to 1 GHz, 2.0 to 2.8 GHz, 3.4 to 3.8 GHz, 3.3 to 4.2 GHz, and 4.4 to 4.6 GHz. The switch can be tuned for other RF frequency bands with a change to some of the external SMT components. An Evaluation Board schematic diagram is shown in Figure 24. The Evaluation Board Bills of Materials for the five different RF bands are shown in Tables 8, 9, 10, 11, and 12.

An assembly drawing for the Evaluation Board is shown in Figure 25. The layer detail physical characteristics are provided in Figure 26.

Recommended Evaluation Board Test Procedure

In Transmit Configuration:

TX-ANT RF Path: (Transmit Mode)

1. With RF power OFF, connect the signal source to the TX port.
2. Connect a spectrum analyzer or power meter to the ANT port.
3. Terminate the RX-port with 50 Ω .
4. Apply +5 V to the VCC pin.
5. Set VCTRL to high.
6. Turn ON the RF power (TX port) and monitor the output signal at the ANT port.

For Shutdown:

1. Turn OFF the RF power.
2. Turn OFF the VCTRL.
3. Turn OFF the VCC.

Note: *Shutdown is not always necessary. The SKY12245-492LF can be hot-switched without consequence.*

In Receive Configuration:

ANT-RX RF Path: (Receive Mode)

1. With RF power OFF, connect the signal source to the ANT port.
2. Connect a spectrum analyzer or power meter to the RX port.
3. Terminate the TX port with 50 Ω .
4. Apply +5 V to the VCC pin.
5. Set VCTRL to low.
6. Turn ON the RF power (ANT port) and monitor the output signal at the RX port.

For Shutdown:

1. Turn OFF the RF power.
2. Turn OFF the VCTRL.
3. Turn OFF the VCC.

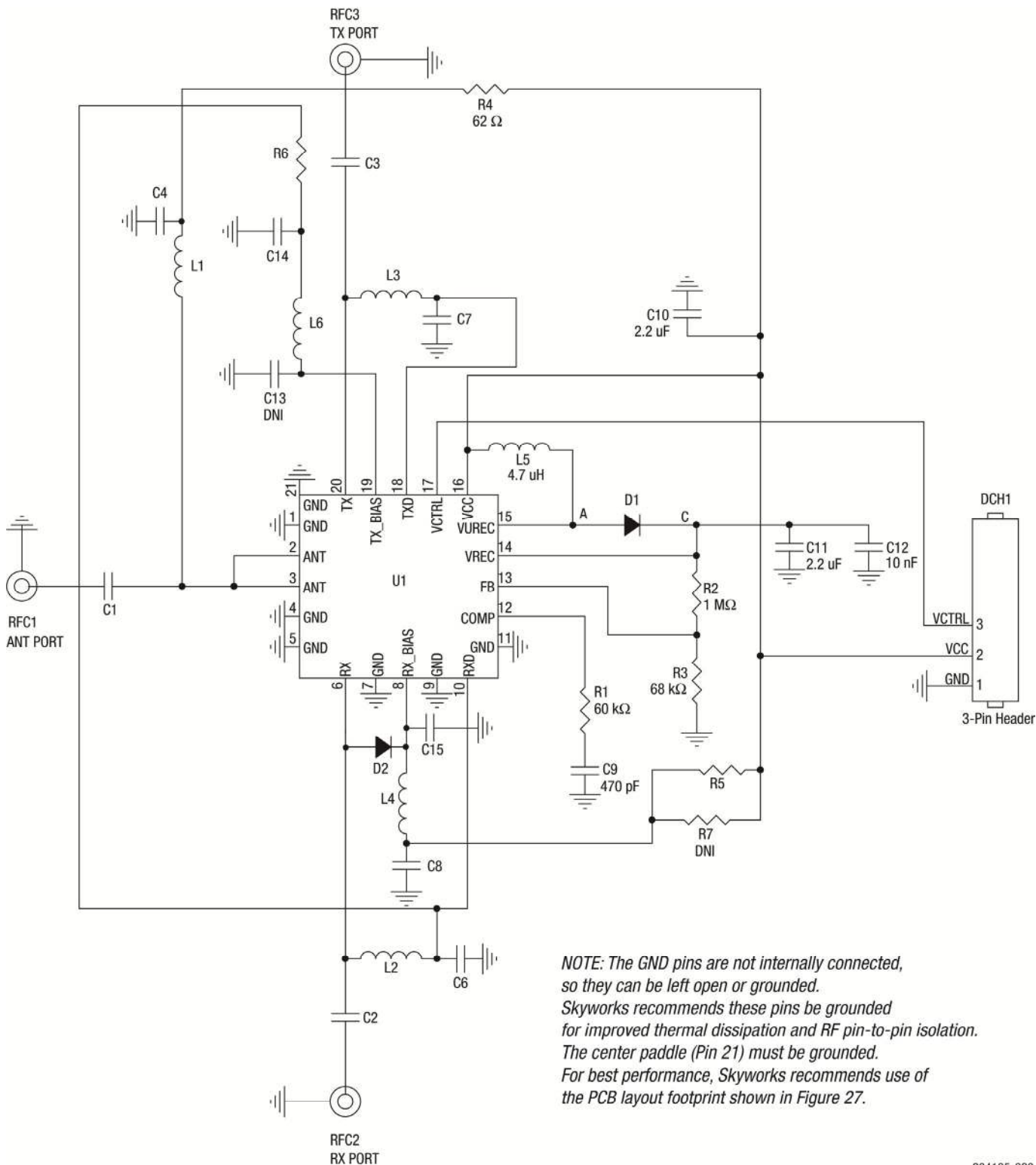

Figure 24. SKY12245-492LF Evaluation Board Schematic

204135-020

Table 8. SKY12245-492LF Evaluation Board Bill of Materials (BoM 1) 0.3 to 1 GHz

Component	Size	Manufacturer	Mfr Part Number	Description
C1	0603	TDK	C1608C0G1H102J080AA	Ceramic capacitor, 1000 pF, ±5%, C0G, 50 V
C2	0402	muRata	GRM155C1H820JA01	Ceramic capacitor, 82 pF, ±5%, C0G, 50 V
C3	0603	TDK	C1608C0G1H560J080AA	Ceramic capacitor, 56 pF, ±5%, C0G, 50 V
C4, C7, C8, C14	0402	TDK	C1005C0G1H101J050BA	Ceramic capacitor, 100 pF, ±5%, C0G, 50 V
C6	0402	muRata	GRM1555C1H221JA01	Ceramic capacitor, 220 pF, ±5%, C0G, 50 V
C9	0402	muRata	GRM155R71H471KA01	Ceramic capacitor, 470 pF, 50 V, X7R, ±10%
C10	0402	muRata	GRM155R61C225KE11	Ceramic capacitor, 2.2 uF, ±10%, X5R, 16 V
C11	0603	muRata	GRM188R61H225KE11	Ceramic capacitor, 2.2 uF, ±10%, X5R, 50 V
C12	0402	muRata	GRM155B31H103KA88	Ceramic capacitor, 10 nF, ±10%, B, 50 V
C15	0402	muRata	GRM1555C1H220JA01	Ceramic capacitor, 22 pF, ±5%, C0G, 50 V
L1	0603	muRata	LQW18ANR10J80D	Inductor, 100 nH, 490 mA, ±5%
L2	0603	muRata	LQW18ANR10J80D	Inductor, 100 nH, 490 mA, ±5%
L3	0603	muRata	LQW18AN82NJ80D	Inductor, 82 nH, 550 mA, ±5%
L4, L6	0402	muRata	LQG15HS82NJ02D	Inductor, 82 nH, 200 mA, ±5%
L5	2.5 x 2.0 x 1.2 mm	muRata	DFE252012P-4R7M	Power inductor, 4.7 uH, 1.4 A, SMD
R1	0402	Panasonic	ERA2AEB6042X	Resistor, 60 kΩ, fixed, SMT, 0.063 W, ±5%
R2	0402	Panasonic	ERJ2GEJ105X	Resistor, 1 MΩ, 50 V, SMT, 0.10 W, ±5%
R3	0402	Panasonic	ERJ2GEJ683X	Resistor, 68 kΩ, 50 V, SMT, 0.10 W, ±5%
R4	0805	ROhm	ESR10EJPJ620	Resistor, 62 Ω, 0.4 W, ±5%
R5	0805	ROhm	ESR10EJPJ431	Resistor, 430 Ω, 0.4 W, ±5%
R6	0603	ROhm	ESR03EJPJ201	Resistor, 200 Ω, 0.25 W, ±5%
D1 ¹	1.6 x 0.8 x 0.6 mm	Diodes Inc.	SDM20U40	0.25 A low VF Schottky Diode SOD-523
D2 ²	1.0 x 0.6 x 0.46 mm	Skyworks	SMP1321-040LF	Packaged PIN Diode, SOD-882
C13, R7	DNI			

¹ If selecting a D1 rectifying diode different from that listed in the BoM, we recommend strong caution. Certain Schottky diodes can have a very fast turn-on time but suffer from thermal runaway because of their high reverse leakage current.

The following attributes are general guidelines for selecting a compatible diode:

- Reverse voltage $V_R > 30$ V
- Reverse Leakage $I_R < 100$ μA @ $V_R = 16$ V, $T_A = 125$ °C
- Junction to ambient thermal resistance: $R_{\theta JA} < 400$ °C/W
- Forward continuous current $I_F > 250$ mA
- Peak forward current $I_{FSM} > 1$ A
- Forward voltage $V_F < 1$ V @ 400 mA

Please contact the Skyworks application team for additional support.

² If selecting an RX side shunt PIN diode different from that listed in the BoM, we recommend strong caution. RX mode insertion loss and TX mode ANT-RX isolation may be degraded.

The following attributes are general guidelines for selecting a compatible diode:

- Capacitance (Ct) ≤ 0.2 pF @ 1 MHz, $V_R = 30$ V
- Resistance (RS) ≤ 1 Ω @ I = 10 mA

Please contact the Skyworks application team for additional support.

Table 9. SKY12245-492LF Evaluation Board Bill of Materials (BoM 2) 2.0 to 2.8 GHz

Component	Size	Manufacturer	Mfr Part Number	Description
C1	0603	TDK	C1608C0G1H102J080AA	Ceramic capacitor, 1000 pF, ±5%, C0G, 50 V
C2	0402	muRata	GRM1555C1H5R6CZ01	Ceramic capacitor, 5.6 pF, ±5%, C0G, 50 V
C3	0603	TDK	C1608C0G2A100D080AA	Ceramic capacitor, 10 pF, ±0.5pF, C0G, 100 V
C4, C7, C8, C14	0402	TDK	C1005C0G1H101J050BA	Ceramic capacitor, 100 pF, ±5%, C0G, 50 V
C6	0402	muRata	GRM1555C1H221JA01	Ceramic capacitor, 220 pF, ±5%, C0G, 50 V
C9	0402	muRata	GRM155R71H471KA01	Ceramic capacitor, 470 pF, 50 V, X7R, ±10%
C10	0402	muRata	GRM155R61C225KE11	Ceramic capacitor, 2.2 uF, ±10%, X5R, 16 V
C11	0603	muRata	GRM188R61H225KE11	Ceramic capacitor, 2.2 uF, ±10%, X5R, 50 V
C12	0402	muRata	GRM155B31H103KA88	Ceramic capacitor, 10 nF, ±10%, B, 50 V
C15	0402	muRata	GJM1555C1H5R6CB01D	Ceramic capacitor, 5.6 pF, ±0.25 pF, C0G, 50 V
L1	0603	muRata	LQW18AN5N6D00D	Inductor, 5.6 nH, 750 mA, ±0.5 nH
L2	0603	muRata	LQW18AN6N8D00D	Inductor, 6.8 nH, 750 mA, ±0.5 nH
L3	0603	muRata	LQW18AN6N8D00D	Inductor, 6.8 nH, 750 mA, ±0.5 nH
L4, L6	0402	muRata	LQG15HS18NJ02D	Inductor, 18 nH, 400 mA, ±5%
L5	2.5 x 2.0 x 1.2 mm	muRata	DFE252012P-4R7M	Power inductor, 4.7 uH, 1.4 A, SMD
R1	0402	Panasonic	ERA2AEB6042X	Resistor, 60 kΩ, fixed, SMT, 0.063 W, ±5%
R2	0402	Panasonic	ERJ2GEJ105X	Resistor, 1 MΩ, 50 V, SMT, 0.10 W, ±5%
R3	0402	Panasonic	ERJ2GEJ683X	Resistor, 68 kΩ, 50 V, SMT, 0.10 W, ±5%
R4	0805	ROhm	ESR10EJPJ620	Resistor, 62 Ω, 0.4 W, ±5%
R5	0805	ROhm	ESR10EJPJ431	Resistor, 430 Ω, 0.4 W, ±5%
R6	0603	ROhm	ESR03EJPJ201	Resistor, 200 Ω, 0.25 W, ±5%
D1 ¹	1.6 x 0.8 x 0.6 mm	Diodes Inc.	SDM20U40	0.25 A low VF Schottky Diode SOD523
D2 ²	1.0 x 0.6 x 0.46 mm	Skyworks	SMP1321-040LF	Packaged PIN Diode, SOD-882
C13, R7	DNI			

¹ If selecting a D1 rectifying diode different from that listed in the BoM, we recommend strong caution. Certain Schottky diodes can have a very fast turn-on time but suffer from thermal runaway because of their high reverse leakage current.

The following attributes are general guidelines for selecting a compatible diode:

- Reverse voltage $V_R > 30$ V
- Reverse Leakage $I_R < 100 \mu A$ @ $V_R = 16$ V, $T_A = 125$ °C
- Junction to ambient thermal resistance: $R_{\theta JA} < 400$ °C/W
- Forward continuous current $I_F > 250$ mA
- Peak forward current $I_{FSM} > 1$ A
- Forward voltage $V_F < 1$ V @ 400 mA

Please contact the Skyworks application team for additional support.

² If selecting an RX side shunt PIN diode different from that listed in the BoM, we recommend strong caution. RX mode insertion loss and TX mode ANT-RX isolation may be degraded.

The following attributes are general guidelines for selecting a compatible diode:

- Capacitance (Ct) ≤ 0.2 pF @ 1 MHz, $V_R = 30$ V
- Resistance (RS) $\leq 1 \Omega$ @ $I = 10$ mA

Please contact the Skyworks application team for additional support.

Table 10. SKY12245-492LF Evaluation Board Bill of Materials (BoM 3) 3.4 to 3.8 GHz

Component	Size	Manufacturer	Mfr Part Number	Description
C1	0603	TDK	C1608C0G1H102J080AA	Ceramic capacitor, 1000 pF, ±5%, C0G, 50 V
C2	0402	muRata	GRM1555C1H5R6CZ01	Ceramic capacitor, 5.6 pF, ±5%, C0G, 50 V
C3	0603	TDK	C1608C0G2A100D080AA	Ceramic capacitor, 10 pF, ±0.5pF, C0G, 100 V
C4, C7, C8, C14	0402	TDK	C1005C0G1H101J050BA	Ceramic capacitor, 100 pF, ±5%, C0G, 50 V
C6	0402	muRata	GRM1555C1H221JA01	Ceramic capacitor, 220 pF, ±5%, C0G, 50 V
C9	0402	muRata	GRM155R71H471KA01	Ceramic capacitor, 470 pF, 50 V, X7R, ±10%
C10	0402	muRata	GRM155R61C225KE11	Ceramic capacitor, 2.2 uF, ±10%, X5R, 16 V
C11	0603	muRata	GRM188R61H225KE11	Ceramic capacitor, 2.2 uF, ±10%, X5R, 50 V
C12	0402	muRata	GRM155B31H103KA88	Ceramic capacitor, 10 nF, ±10%, B, 50 V
C15	0402	muRata	GJM1555C1H2R4CB01D	Ceramic capacitor, 2.4 pF, ±0.25 pF, C0G, 50 V
L1	0603	muRata	LQW18AN6N8D00D	Inductor, 6.8 nH, 750 mA, ±0.5 nH
L2	0603	muRata	LQG18HN10NJ00D	Inductor, 10 nH, 400 mA, ±5%
L3	0603	muRata	LQG18HN10NJ00D	Inductor, 10 nH, 400 mA, ±5%
L4, L6	0402	muRata	LQG15HS18NJ02D	Inductor, 18 nH, 400 mA, ±5%
L5	2.5 x 2.0 x 1.2 mm	muRata	DFE252012P-4R7M	Power inductor, 4.7 uH, 1.4 A, SMD
R1	0402	Panasonic	ERA2AEB6042X	Resistor, 60 kΩ, fixed, SMT, 0.063 W, ±5%
R2	0402	Panasonic	ERJ2GEJ105X	Resistor, 1 MΩ, 50 V, SMT, 0.10 W, ±5%
R3	0402	Panasonic	ERJ2GEJ683X	Resistor, 68 kΩ, 50 V, SMT, 0.10 W, ±5%
R4	0805	ROhm	ESR10EJPJ620	Resistor, 62 Ω, 0.4 W, ±5%
R5	0805	ROhm	ESR10EJPJ431	Resistor, 430 Ω, 0.4 W, ±5%
R6	0603	ROhm	ESR03EJPJ201	Resistor, 200 Ω, 0.25 W, ±5%
D1 ¹	1.6 x 0.8 x 0.6 mm	Diodes Inc.	SDM20U40	0.25 A low VF Schottky Diode SOD-523
D2 ²	1.0 x 0.6 x 0.46 mm	Skyworks	SMP1321-040LF	Packaged PIN Diode, SOD-882
C13, R7	DNI			

¹ If selecting a D1 rectifying diode different from that listed in the BoM, we recommend strong caution. Certain Schottky diodes can have a very fast turn-on time but suffer from thermal runaway because of their high reverse leakage current.

The following attributes are general guidelines for selecting a compatible diode:

- Reverse voltage $V_R > 30$ V
- Reverse Leakage $I_R < 100$ μA @ $V_R = 16$ V, $T_A = 125$ °C
- Junction to ambient thermal resistance: $R_{\theta JA} < 400$ °C/W
- Forward continuous current $I_F > 250$ mA
- Peak forward current $I_{FSM} > 1$ A
- Forward voltage $V_F < 1$ V @ 400 mA

Please contact the Skyworks application team for additional support.

² If selecting an RX side shunt PIN diode different from that listed in the BoM, we recommend strong caution. RX mode insertion loss and TX mode ANT-RX isolation may be degraded.

The following attributes are general guidelines for selecting a compatible diode:

- Capacitance (Ct) ≤ 0.2 pF @ 1 MHz, $V_R = 30$ V
- Resistance (RS) ≤ 1 Ω @ I = 10 mA

Please contact the Skyworks application team for additional support.

Table 11. SKY12245-492LF Evaluation Board Bill of Materials (BoM 4) 3.3 to 4.2 GHz

Component	Size	Manufacturer	Mfr Part Number	Description
C1	0603	TDK	C1608C0G1H102J080AA	Ceramic capacitor, 1000 pF, ±5%, C0G, 50 V
C2	0402	muRata	GJM1555C1H100GB01D	Ceramic capacitor, 10 pF, ±2%, C0G, 50 V
C3	0603	TDK	C1608C0G2A100D080AA	Ceramic capacitor, 10 pF, ±0.5pF, C0G, 100 V
C4, C7, C8, C14	0402	TDK	C1005C0G1H101J050BA	Ceramic capacitor, 100 pF, ±5%, C0G, 50 V
C6	0402	muRata	GRM1555C1H221JA01	Ceramic capacitor, 220 pF, ±5%, C0G, 50 V
C9	0402	muRata	GRM155R71H471KA01	Ceramic capacitor, 470 pF, 50 V, X7R, ±10%
C10	0402	muRata	GRM155R61C225KE11	Ceramic capacitor, 2.2 uF, ±10%, X5R, 16 V
C11	0603	muRata	GRM188R61H225KE11	Ceramic capacitor, 2.2 uF, ±10%, X5R, 50 V
C12	0402	muRata	GRM155B31H103KA88	Ceramic capacitor, 10 nF, ±10%, B, 50 V
C15	0402	muRata	GJM1555C1H2R0BB01D	Ceramic capacitor, 2.0 pF, ±0.1 pF, C0G, 50 V
L1	0603	muRata	LQW18AN5N6D00D	Inductor, 5.6 nH, 750 mA, ±0.5 nH
L2	0603	muRata	LQG18HN22NJ00D	Inductor, 22 nH, 300 mA, ±5%
L3	0603	muRata	LQG18HN10NJ00D	Inductor, 10 nH, 400 mA, ±5%
L4, L6	0402	muRata	LQG15HS18NJ02D	Inductor, 18 nH, 400 mA, ±5%
L5	2.5 x 2.0 x 1.2 mm	muRata	DFE252012P-4R7M	Power inductor, 4.7 uH, 1.4 A, SMD
R1	0402	Panasonic	ERA2AEB6042X	Resistor, 60 kΩ, fixed, SMT, 0.063 W, ±5%
R2	0402	Panasonic	ERJ2GEJ105X	Resistor, 1 MΩ, 50 V, SMT, 0.10 W, ±5%
R3	0402	Panasonic	ERJ2GEJ683X	Resistor, 68 kΩ, 50 V, SMT, 0.10 W, ±5%
R4	0805	ROhm	ESR10EZPJ620	Resistor, 62 Ω, 0.4 W, ±5%
R5	0805	ROhm	ESR10EZPJ911	Resistor, 910 Ω, 0.4 W, ±5%
R6	0603	ROhm	ESR03EZPJ471	Resistor, 470 Ω, 0.25 W, ±5%
D1 ¹	1.6 x 0.8 x 0.6 mm	Diodes Inc.	SDM20U40	0.25 A low VF Schottky Diode SOD-523
D2 ²	1.0 x 0.6 x 0.46 mm	Skyworks	SMP1321-040LF	Packaged PIN Diode, SOD-882
C13, R7	DNI			

¹ If selecting a D1 rectifying diode different from that listed in the BoM, we recommend strong caution. Certain Schottky diodes can have a very fast turn-on time but suffer from thermal runaway because of their high reverse leakage current.

The following attributes are general guidelines for selecting a compatible diode:

- Reverse voltage $V_R > 30$ V
- Reverse Leakage $I_R < 100$ μA @ $V_R = 16$ V, $T_A = 125$ °C
- Junction to ambient thermal resistance: $R_{\theta JA} < 400$ °C/W
- Forward continuous current $I_F > 250$ mA
- Peak forward current $I_{FSM} > 1$ A
- Forward voltage $V_F < 1$ V @ 400 mA

Please contact the Skyworks application team for additional support.

² If selecting an RX side shunt PIN diode different from that listed in the BoM, we recommend strong caution. RX mode insertion loss and TX mode ANT-RX isolation may be degraded.

The following attributes are general guidelines for selecting a compatible diode:

- Capacitance (Ct) ≤ 0.2 pF @ 1 MHz, $V_R = 30$ V
- Resistance (RS) ≤ 1 Ω @ I = 10 mA

Please contact the Skyworks application team for additional support.

Table 12. SKY12245-492LF Evaluation Board Bill of Materials (BoM 5) 4.4 to 4.6 GHz

Component	Size	Manufacturer	Mfr Part Number	Description
C1	0603	TDK	C1608C0G1H102J080AA	Ceramic capacitor, 1000 pF, ±5%, C0G, 50 V
C2	0402	muRata	GJM1555C1H100GB01D	Ceramic capacitor, 10 pF, ±2%, C0G, 50 V
C3	0603	TDK	C1608C0G2A100D080AA	Ceramic capacitor, 10 pF, ±0.5pF, C0G, 100 V
C4, C7, C8, C14	0402	TDK	C1005C0G1H101J050BA	Ceramic capacitor, 100 pF, ±5%, C0G, 50 V
C6	0402	muRata	GRM1555C1H221JA01	Ceramic capacitor, 220 pF, ±5%, C0G, 50 V
C9	0402	muRata	GRM155R71H471KA01	Ceramic capacitor, 470 pF, 50 V, X7R, ±10%
C10	0402	muRata	GRM155R61C225KE11	Ceramic capacitor, 2.2 uF, ±10%, X5R, 16 V
C11	0603	muRata	GRM188R61H225KE11	Ceramic capacitor, 2.2 uF, ±10%, X5R, 50 V
C12	0402	muRata	GRM155B31H103KA88	Ceramic capacitor, 10 nF, ±10%, B, 50 V
C15	0402	muRata	GJM1555C1H1R5BB01D	Ceramic capacitor, 1.5 pF, ±0.1 pF, C0G, 50 V
L1	0603	muRata	LQW18AN2N2C00	Inductor, 2.2 nH, 750 mA, ±0.5 nH
L2	0603	muRata	LQW18AN23NG00	Inductor, 24 nH, 300 mA, ±5%
L3	0603	muRata	LQW18AN30NG00	Inductor, 30 nH, 400 mA, ±5%
L4, L6	0402	muRata	LQG15HS18NJ02D	Inductor, 18 nH, 400 mA, ±5%
L5	2.5 x 2.0 x 1.2 mm	muRata	DFE252012P-4R7M	Power inductor, 4.7 uH, 1.4 A, SMD
R1	0402	Panasonic	ERA2AEB6042X	Resistor, 60 kΩ, fixed, SMT, 0.063 W, ±5%
R2	0402	Panasonic	ERJ2GEJ105X	Resistor, 1 MΩ, 50 V, SMT, 0.10 W, ±5%
R3	0402	Panasonic	ERJ2GEJ683X	Resistor, 68 kΩ, 50 V, SMT, 0.10 W, ±5%
R4	0805	ROhm	ESR10EJPJ620	Resistor, 62 Ω, 0.4 W, ±5%
R5	0805	ROhm	ESR10EJPJ431	Resistor, 430 Ω, 0.4 W, ±5%
R6	0603	ROhm	ESR03EJPJ201	Resistor, 200 Ω, 0.25 W, ±5%
D1 ¹	1.6 x 0.8 x 0.6 mm	Diodes Inc.	SDM20U40	0.25 A low VF Schottky Diode SOD-523
D2 ²	1.0 x 0.6 x 0.46 mm	Skyworks	SMP1321-040LF	Packaged PIN Diode, SOD-882
C13, R7	DNI			

¹ If selecting a D1 rectifying diode different from that listed in the BoM, we recommend strong caution. Certain Schottky diodes can have a very fast turn-on time, but suffer from thermal runaway because of their high reverse leakage current.

The following attributes are general guidelines for selecting a compatible diode:

- Reverse voltage $V_R > 30$ V
- Reverse Leakage $I_R < 100$ μA @ $V_R = 16$ V, $T_A = 125$ °C
- Junction to ambient thermal resistance: $R_{\theta JA} < 400$ °C/W
- Forward continuous current $I_F > 250$ mA
- Peak forward current $I_{FSM} > 1$ A
- Forward voltage $V_F < 1$ V @ 400 mA

Please contact the Skyworks application team for additional support.

² If selecting an RX side shunt PIN diode different from that listed in the BoM, we recommend strong caution. RX mode insertion loss and TX mode ANT-RX isolation may be degraded.

The following attributes are general guidelines for selecting a compatible diode:

- Capacitance (Ct) ≤ 0.2 pF @ 1 MHz, $V_R = 30$ V
- Resistance (RS) ≤ 1 Ω @ I = 10 mA

Please contact the Skyworks application team for additional support.

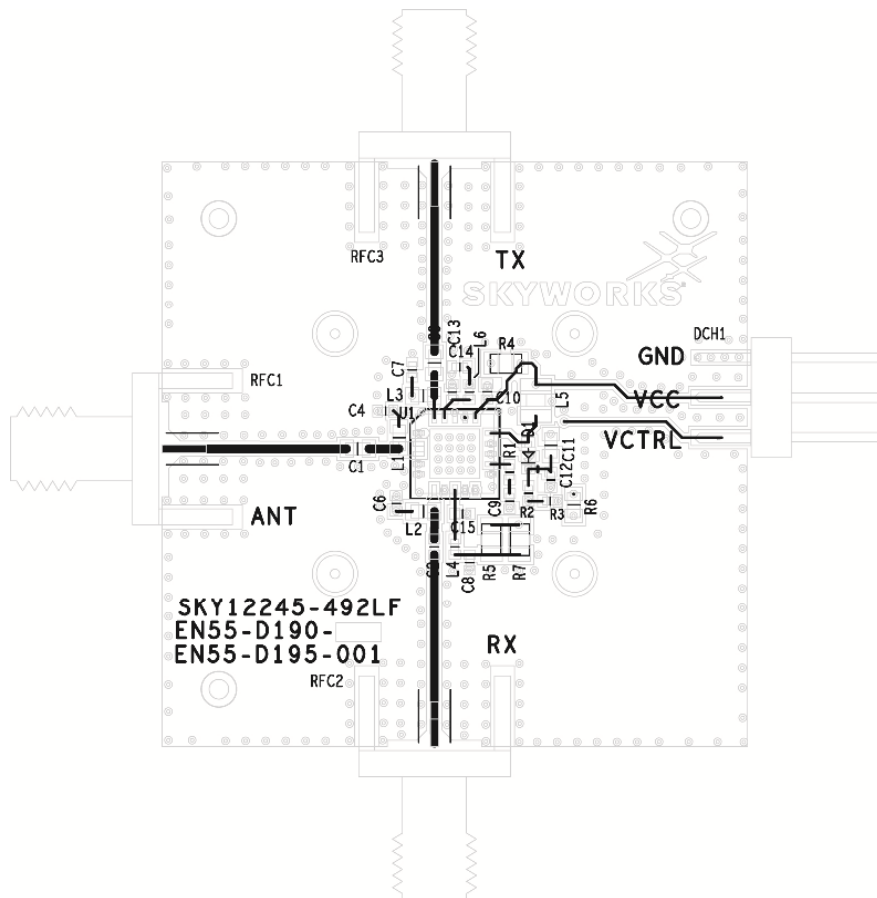

Figure 25. SKY12245-492LF Evaluation Board Assembly Diagram

Cross Section	Name	Thickness (in)	Material
	Top Solder Mask		
	L1	(0.0028)	Cu foil
	Laminate	0.012 ± 0.0006	Rogers R04003C Core
	L2	(0.0014)	Cu foil
	Laminate	(Note 1)	FR4 Prepreg
	L3	(0.0014)	Cu foil
	Laminate	0.010 ± 0.0006	FR4 Core
	L4	(0.0028)	Cu foil
	Bottom Solder Mask		

Note: Adjust this thickness to meet total thickness goal of 0.062 ± 0.005 inch.

204135-022

Figure 26. SKY12245-492LF Layer Detail Physical Characteristics

Package Dimensions

The PCB layout footprint for the SKY12245-492LF is shown in Figure 27. Typical part markings are noted in Figure 28. Package dimensions are shown in Figure 29, and tape and reel dimensions are provided in Figure 30.

Package and Handling Information

Since the device package is sensitive to moisture absorption, it is baked and vacuum packed before shipping. Instructions on the shipping container label regarding exposure to moisture after the container seal is broken must be followed. Otherwise, problems related to moisture absorption may occur when the part is subjected to high temperature during solder assembly.

The SKY12245-492LF is rated to Moisture Sensitivity Level 3 (MSL3) at 260 °C. It can be used for lead or lead-free soldering. For additional information, refer to the Skyworks Application Note, *Solder Reflow Information*, document number 200164.

Care must be taken when attaching this product, whether it is done manually or in a production solder reflow environment. Production quantities of this product are shipped in a standard tape and reel format.

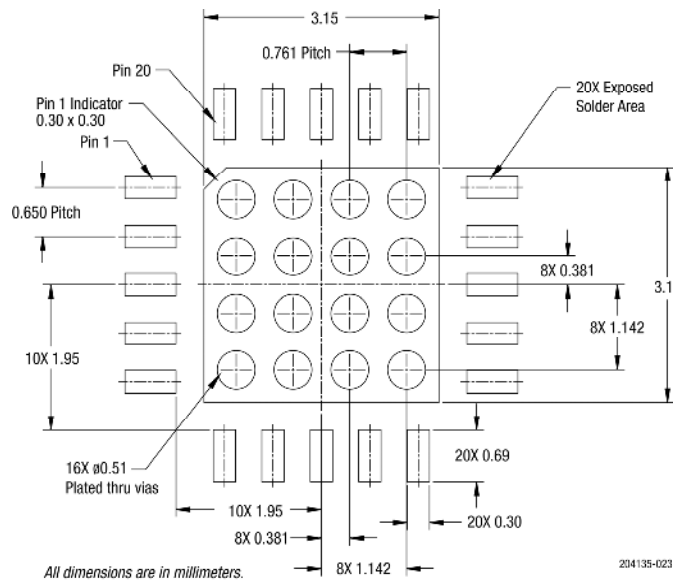

Figure 27. PCB Layout Footprint

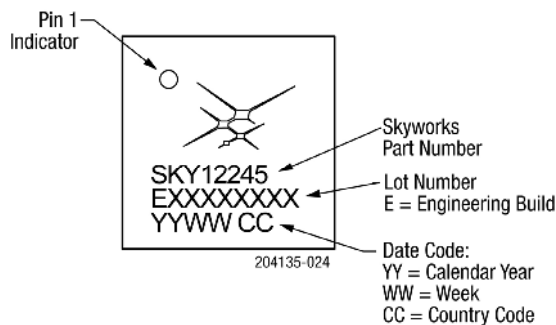
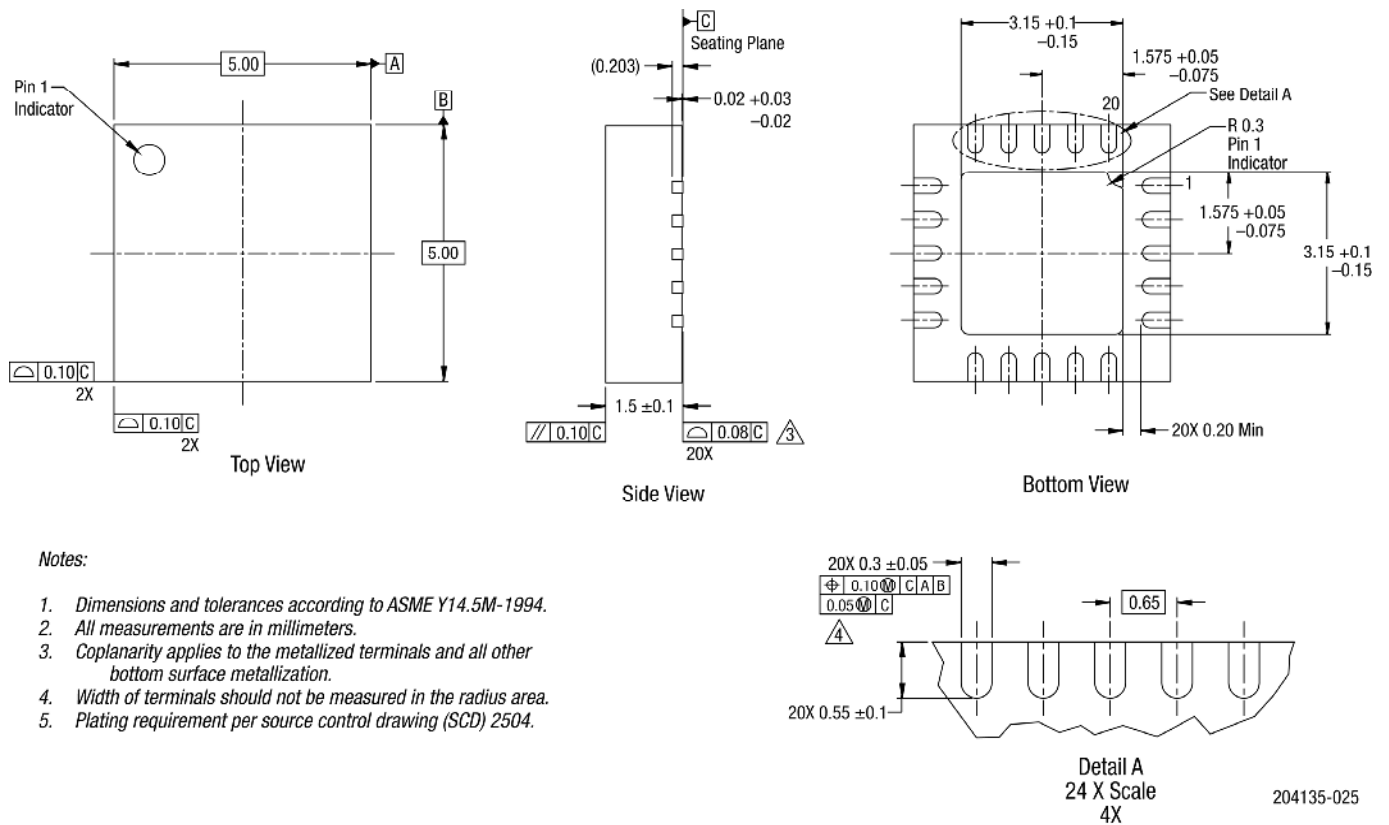

Figure 28. Typical Part Markings (Top View)



Notes:

1. Dimensions and tolerances according to ASME Y14.5M-1994.
2. All measurements are in millimeters.
3. Coplanarity applies to the metallized terminals and all other bottom surface metallization.
4. Width of terminals should not be measured in the radius area.
5. Plating requirement per source control drawing (SCD) 2504.

Figure 29. SKY12245-492LF Package Dimensions

DATA SHEET • SKY12245-492LF: 100 W Compact High-Power SPDT Switch with Integrated Driver

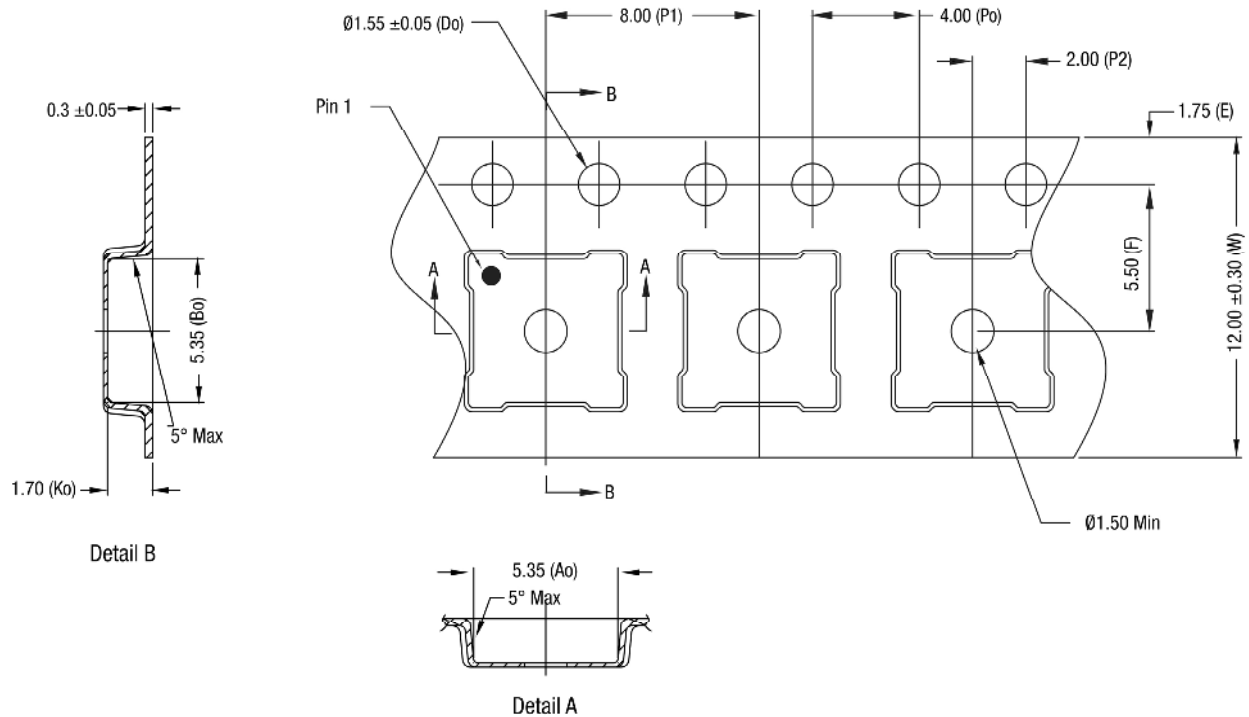

Notes:

1. Carrier tapes must meet all requirements of Skyworks GP01-D233 procurement spec for tape and reel shipping.
2. Carrier tape shall be black conductive polystyrene.
3. Cover tape shall be transparent conductive material.
4. ESD-surface resistivity shall be $\leq 1 \times 10^{10}$ Ohms/square per EIA, JEDEC TNR specification.
5. P0/P1 10 pitches cumulative tolerance on tape: ± 0.20 mm.
6. Ao & Bo measurement point to be 0.30 mm from bottom pocket.
7. All dimensions are in millimeters.

204135-026

Figure 30. SKY12245-492LF Tape and Reel Dimensions

Ordering Information

Part Number	Product Description	Evaluation Board Part Number
SKY12245-492LF	SKY12245-492LF 0.3 to 1.0 GHz BoM 1	SKY12245-492EK1
SKY12245-492LF	SKY12245-492LF 2.0 to 2.8 GHz BoM 2	SKY12245-492EK2
SKY12245-492LF	SKY12245-492LF 3.4 to 3.8 GHz BoM 3	SKY12245-492EK3
SKY12245-492LF	SKY12245-492LF 3.3 to 4.2 GHz BoM 4	SKY12245-492EK4
SKY12245-492LF	SKY12245-492LF 4.4 to 4.6 GHz BoM 5	SKY12245-492EK5

Copyright © 2016-2020 Skyworks Solutions, Inc. All Rights Reserved.

Information in this document is provided in connection with Skyworks Solutions, Inc. ("Skyworks") products or services. These materials, including the information contained herein, are provided by Skyworks as a service to its customers and may be used for informational purposes only by the customer. Skyworks assumes no responsibility for errors or omissions in these materials or the information contained herein. Skyworks may change its documentation, products, services, specifications or product descriptions at any time, without notice. Skyworks makes no commitment to update the materials or information and shall have no responsibility whatsoever for conflicts, incompatibilities, or other difficulties arising from any future changes.

No license, whether express, implied, by estoppel or otherwise, is granted to any intellectual property rights by this document. Skyworks assumes no liability for any materials, products or information provided hereunder, including the sale, distribution, reproduction or use of Skyworks products, information or materials, except as may be provided in Skyworks Terms and Conditions of Sale.

THE MATERIALS, PRODUCTS AND INFORMATION ARE PROVIDED "AS IS" WITHOUT WARRANTY OF ANY KIND, WHETHER EXPRESS, IMPLIED, STATUTORY, OR OTHERWISE, INCLUDING FITNESS FOR A PARTICULAR PURPOSE OR USE, MERCHANTABILITY, PERFORMANCE, QUALITY OR NON-INFRINGEMENT OF ANY INTELLECTUAL PROPERTY RIGHT; ALL SUCH WARRANTIES ARE HEREBY EXPRESSLY DISCLAIMED. SKYWORKS DOES NOT WARRANT THE ACCURACY OR COMPLETENESS OF THE INFORMATION, TEXT, GRAPHICS OR OTHER ITEMS CONTAINED WITHIN THESE MATERIALS. SKYWORKS SHALL NOT BE LIABLE FOR ANY DAMAGES, INCLUDING BUT NOT LIMITED TO ANY SPECIAL, INDIRECT, INCIDENTAL, STATUTORY, OR CONSEQUENTIAL DAMAGES, INCLUDING WITHOUT LIMITATION, LOST REVENUES OR LOST PROFITS THAT MAY RESULT FROM THE USE OF THE MATERIALS OR INFORMATION, WHETHER OR NOT THE RECIPIENT OF MATERIALS HAS BEEN ADVISED OF THE POSSIBILITY OF SUCH DAMAGE.

Skyworks products are not intended for use in medical, lifesaving or life-sustaining applications, or other equipment in which the failure of the Skyworks products could lead to personal injury, death, physical or environmental damage. Skyworks customers using or selling Skyworks products for use in such applications do so at their own risk and agree to fully indemnify Skyworks for any damages resulting from such improper use or sale.

Customers are responsible for their products and applications using Skyworks products, which may deviate from published specifications as a result of design defects, errors, or operation of products outside of published parameters or design specifications. Customers should include design and operating safeguards to minimize these and other risks. Skyworks assumes no liability for applications assistance, customer product design, or damage to any equipment resulting from the use of Skyworks products outside of stated published specifications or parameters.

Skyworks and the Skyworks symbol are trademarks or registered trademarks of Skyworks Solutions, Inc. or its subsidiaries in the United States and other countries. Third-party brands and names are for identification purposes only and are the property of their respective owners. Additional information, including relevant terms and conditions, posted at www.skyworksinc.com, are incorporated by reference.