

NEW!

PVB6 Low Profile Push Switches

Features/Benefits

- Compact design
- Adapted for medium power applications
- SMT & THT soldering process
- Tape & reel packaging for SMT version
- RoHS compliant and compatible

Typical Applications

- Automotive (air conditioning, lighting)
- Industrial
- Control panels



Construction

FUNCTION: Momentary, Push-Push
 CONTACT ARRANGEMENT: DPDT
 SWITCHING MODE: Non-shorting
 TERMINALS: G termination for SMT version;
 PC Pins for THT version

Mechanical

TOTAL TRAVEL / LATCHING TRAVEL:
 OA: 2,3 mm
 EE: 2,3 / 1,5 mm
 OPERATING FORCE: 3N

Process

SOLDERING:
 SMT: Lead free reflow soldering profile compatible
 THT: Lead free wave soldering profile compatible,
 Hand soldering, 350°C for 3 s

Electrical

SWITCHING POWER MAX.: 2,8 W DC
 SWITCHING VOLTAGE MAX.: 14 V DC
 SWITCHING CURRENT MAX.: 200 mA DC
 DIELECTRIC STRENGTH (50 Hz / 1 min): 500 V between open contacts
 OPERATING LIFE:
 OA (momentary): $\geq 3 \times 10^5$ operations
 EE (push-push): $\geq 3 \times 10^5$ operations
 CONTACT RESISTANCE: Initial $\leq 150 \text{ m}\Omega$
 INSULATION RESISTANCE: $\geq 10^8 \Omega$ (100 VDC - 60s)

Environmental

OPERATING TEMPERATURE: -40°C to 80°C

Packaging

200 pieces per reel for SMT version
 1600 pieces per box for THT version

How To Order

Our easy build-a-switch concept allows you to mix and match options to create the switch you need. To order, select desired option from each category and place it in the appropriate box. **Some of the configurations may not be available or could require some development.**

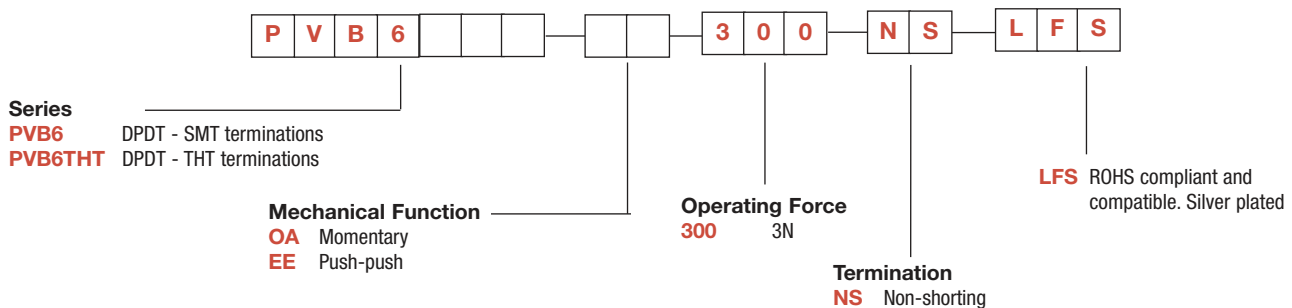

D

Key Switches

PVB6 Low Profile Push Switches

NEW!

PVB6 OA MOMENTARY

ELECTRICAL SCHEMATIC

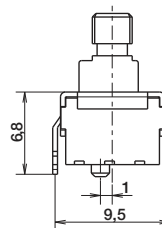
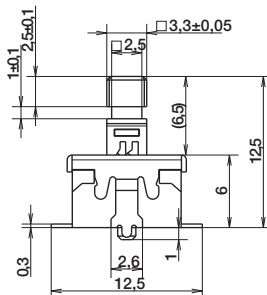
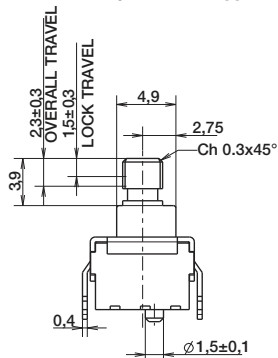
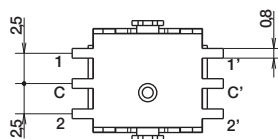
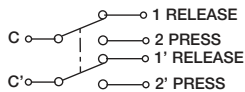

PCB LAYOUT (top view)

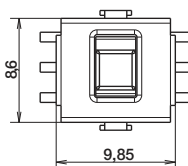
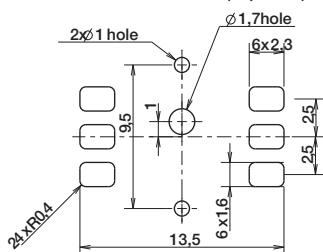

PVB6 EE PUSH PUSH

ELECTRICAL SCHEMATIC

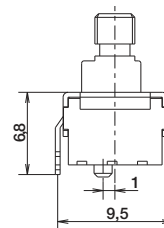
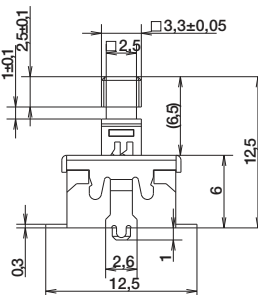
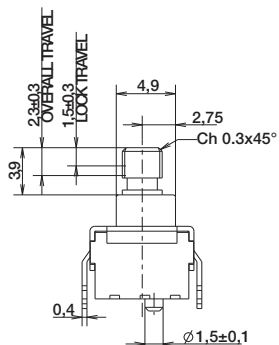
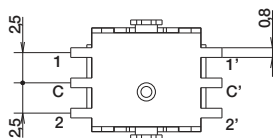
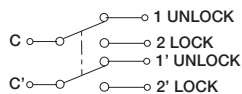

PCB LAYOUT (top view)

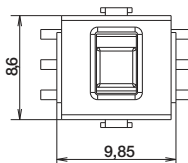
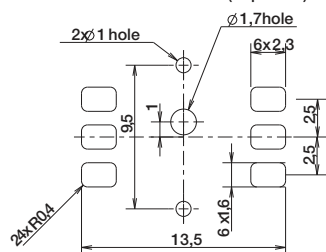

D

Key Switches

PVB6 Low Profile Push Switches

NEW!

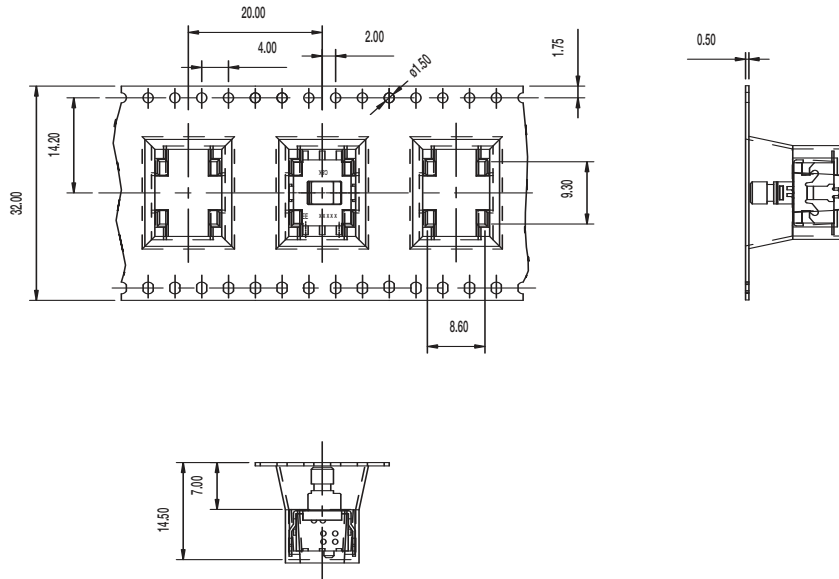

Key Switches