

Purpose

The RT8008 is a high-efficiency 1.5MHz current mode synchronous step-down regulator that can deliver up to 600mA output current from an input voltage range of 2.5V to 5.5V. This document explains the function and use of the RT8008 evaluation board (EVB) and provides information to enable operation and modification of the evaluation board and circuit to suit individual requirements.

Table of Contents

<i>Purpose</i>	1
<i>Introduction</i>	2
<i>General Product Information</i>	2
<i>Key Performance Summary Table</i>	3
<i>Bench Test Setup Conditions</i>	4
<i>Headers Description and Placement</i>	4
<i>Test Points</i>	4
<i>Power-up & Measurement Procedure</i>	5
<i>Output Voltage Setting</i>	5
<i>Schematic, Bill of Materials and Board Layout</i>	6
<i>EVB Schematic Diagram</i>	6
<i>Bill of Materials</i>	6
<i>EVB Layout</i>	7
<i>More Information</i>	10
<i>Important Notice for Richtek Evaluation Board</i>	10

Introduction

General Product Information

General Description

The RT8008 is a high-efficiency pulse-width-modulated (PWM) step-down DC/DC converter. Capable of delivering 600mA output current over an input voltage range of 2.5V to 5.5V, the RT8008 is ideally suited for portable electronic devices that are powered from 1-cell Li-ion battery (or from other power sources within that range) such as cellular phones, PDAs and handy-terminals.

An internal synchronous rectifier with low $R_{DS(ON)}$ dramatically reduces conduction losses in PWM mode. No external Schottky diode is required in practical applications. The RT8008 automatically turns off the synchronous rectifier when the inductor current is low entering discontinuous PFM mode to increase efficiency at light loads.

The RT8008 enters Low-Dropout mode when normal PWM operation cannot regulate the output voltage, turning on the upper P-MOSFET continuously. The RT8008 enters shutdown mode and consumes less than 0.1 μ A when EN pin is pulled low.

The switching ripple is easily smoothed-out by small sized filtering elements due to a fixed operating frequency of 1.5MHz. This, along with its small SOT-23-5 and TSOT-23-5 packages provides a small PCB area. Other features include soft start, low internal reference voltage with 2% accuracy, over temperature protection, and over current protection.

Features

- 2.5V to 5.5V Input Range
- Adjustable Output from 0.6V to VIN
- 1.0V, 1.2V, 1.5V, 1.8V, 2.5V and 3.3V Fixed/ Adjustable Output Voltage
- 600mA Output Current, 1A Peak Current
- 95% Efficiency
- No Schottky Diode Required
- 1.5MHz Fixed Frequency at PWM Operation
- Small SOT-23-5 and TSOT-23-5 Package
- RoHS Compliant and 100% Lead (Pb)-Free

Key Performance Summary Table

Key features	Evaluation board number: PCB003_V1
Default Input Voltage	5V
Max Output Current	600mA
Default Output Voltage	1.2V
Default Marking & Package Type	RT8008GB, SOT-23-5
Operation Frequency	Steady 1.5MHz at PWM
Other Key Features	PSM/ PWM Auto Switched.
Protection	Over Current Protection, Over Temperature Protection

Bench Test Setup Conditions

Headers Description and Placement

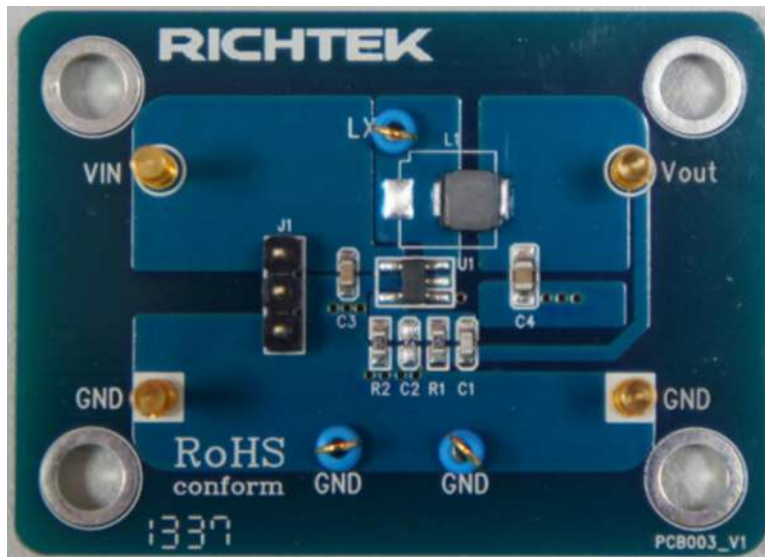

Please carefully inspect the EVB IC and external components, comparing them to the following Bill of Materials, to ensure that all components are installed and undamaged. If any components are missing or damaged during transportation, please contact the distributor or send e-mail to evb_service@richtek.com.

Test Points

The EVB is provided with the test points and pin names listed in the table below.

Test point/ Pin name	Signal	Comment (expected waveforms or voltage levels on test points)
VIN	Input voltage	Input voltage range= 2.5V to 5.5V
VOUT	Output voltage	Default Output Voltage = 1.2V Output voltage range= 0.6V to 5V (see " Output Voltage Setting" section for changing output voltage level)
LX	Switching node test point	LX waveform
J1	Chip Enable control	Drive EN or install a shorting block on Jumper J1 to enable operation (shorting 1-2) or disable operation (shorting 2-3).
GND	Ground	Ground

Power-up & Measurement Procedure

1. Apply a 5V nominal input power supply ($2.5V < V_{IN} < 5.5V$) to the VIN and GND terminals.
2. Place a shorting block across pins 1 and 2 of the J1 jumper to connect EN to VIN ($>1.5V$), to turn on the converter. Short pins 2-3, connecting EN to GND, to turn off the converter.
3. Verify the output voltage (approximately 1.2V) between VOUT and GND.
4. Connect an external load up to 600mA to the VOUT and GND terminals and verify the output voltage and current.

Output Voltage Setting

Set the output voltage with the resistive divider (R1, R2) between VOUT and GND with the midpoint connected to FB. The output is set by the following formula:

$$V_{OUT} = 0.6 \times \left(1 + \frac{R1}{R2}\right)$$

The installed VOUT capacitor (C4) is a 10 μ F, 6.3V X5R ceramic type. For higher output voltages, consider its voltage coefficient (capacitance vs. bias voltage) and ensure that the capacitance is sufficient to maintain stability and provide sufficient transient response for your application. This can be verified by checking the output transient response as described in the RT8008 IC datasheet.

Schematic, Bill of Materials and Board Layout

EVB Schematic Diagram

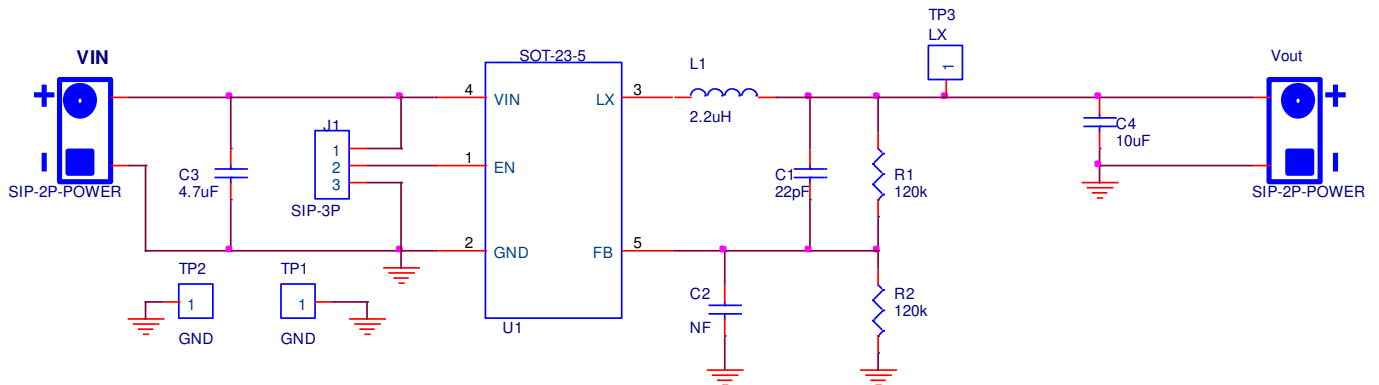

C3: 4.7µF/6.3V/X5R, 0603, TDK C2012X5R0J475M

C4: 10µF/6.3V/X5R, 0805, TDK C2012X5R0J106M

L1: 2.2µH TAIYO YUDEN NR3015T2R2M, DCR=60mΩ

Bill of Materials

Reference	Qty	Part number	Description	Package	Manufacture
U1	1	RT8008GB	DC-DC Converter	SOT-23-5	Richtek
C1	1	0603B220K500NT	22pF/±10%/50V/X7R Ceramic Capacitor	0603	WALSIN
C2	0		Not Installed	0603	
C3	1	C2012X5R0J475M	4.7µF/±20%/6.3V/X5R Ceramic Capacitor	0603	TDK
C4	1	C2012X5R0J106M	10µF/±20%/6.3V/X5R Ceramic Capacitor	0805	TDK
L1	1	NR3015T2R2M	2.2µH/1.5A/±20%, DCR=60mΩ, Inductor	3mmx3mmx1.5mm	TAIYO YUDEN
R1	1		120kΩ/±1%, Resistor	0603	
R2	1		120kΩ/±1%, Resistor	0603	
J1	1		3-Pin Header		
TP	3		Test Pin		
GP	4		Golden Pin		

EVB Layout

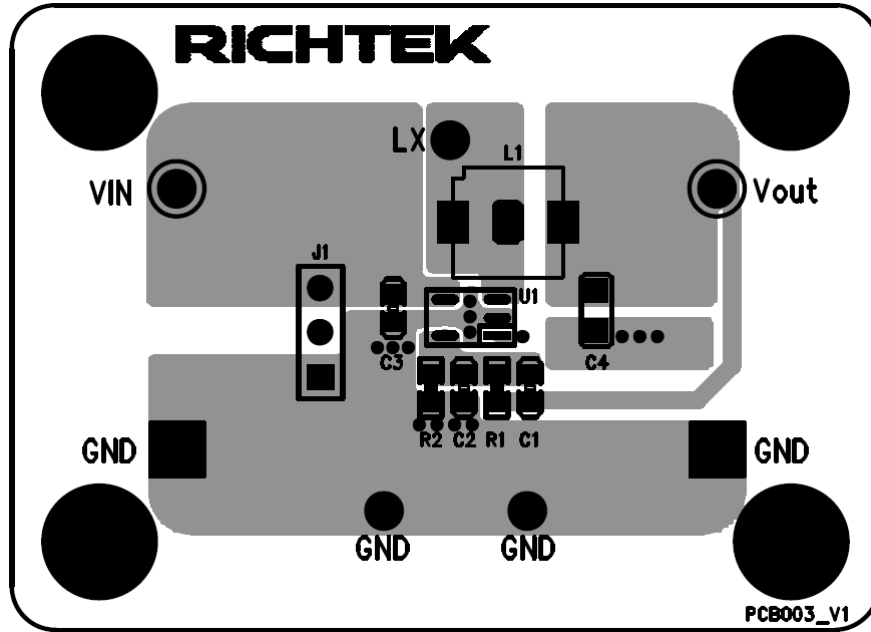

Top View (1st layer)

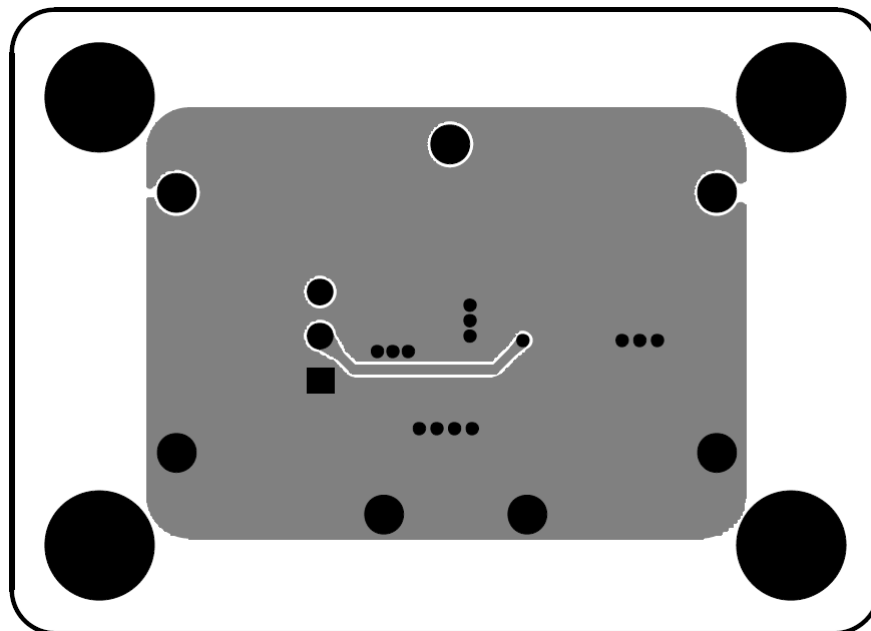

Bottom View (2nd Layer)

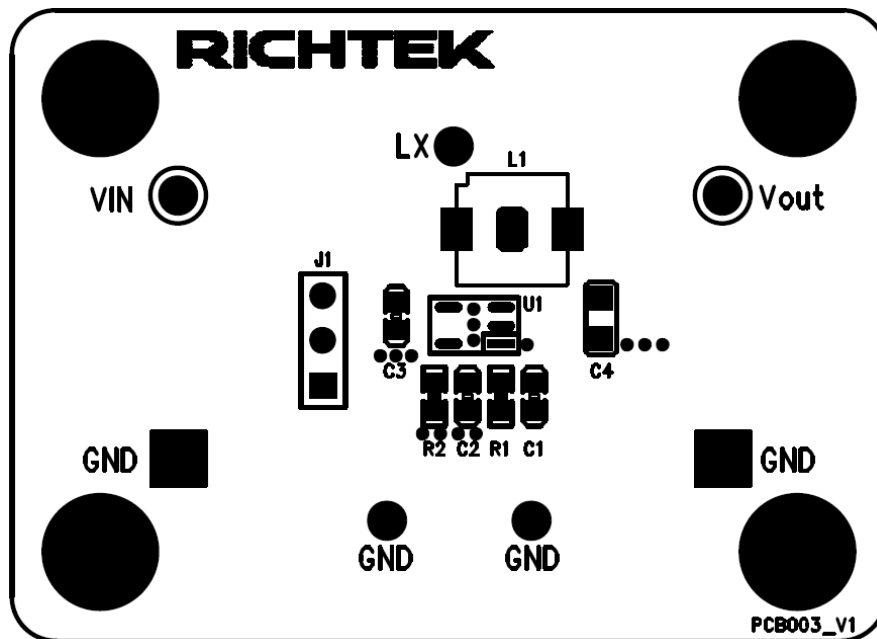

Component Placement Guide—Component Side (1st layer)

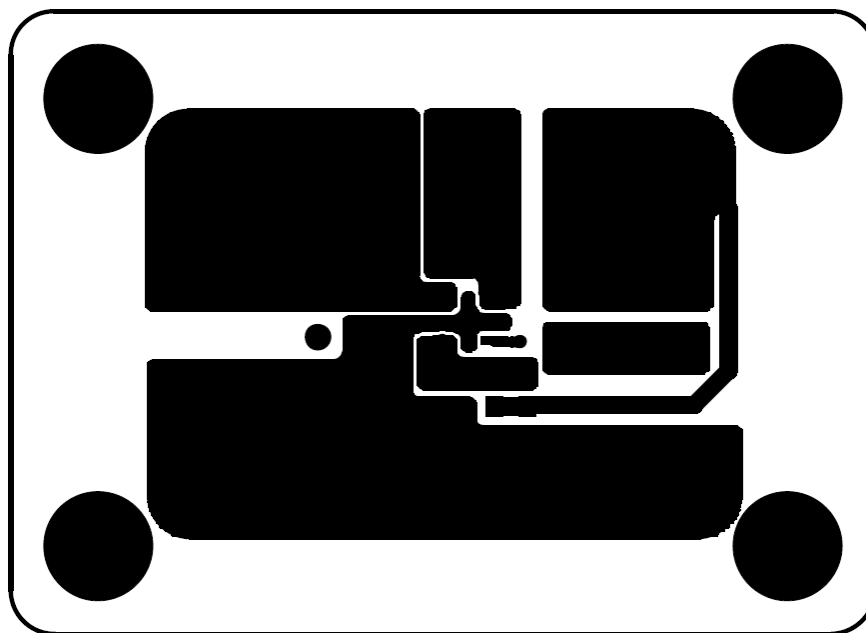

PCB Layout—Component Side (1st Layer)

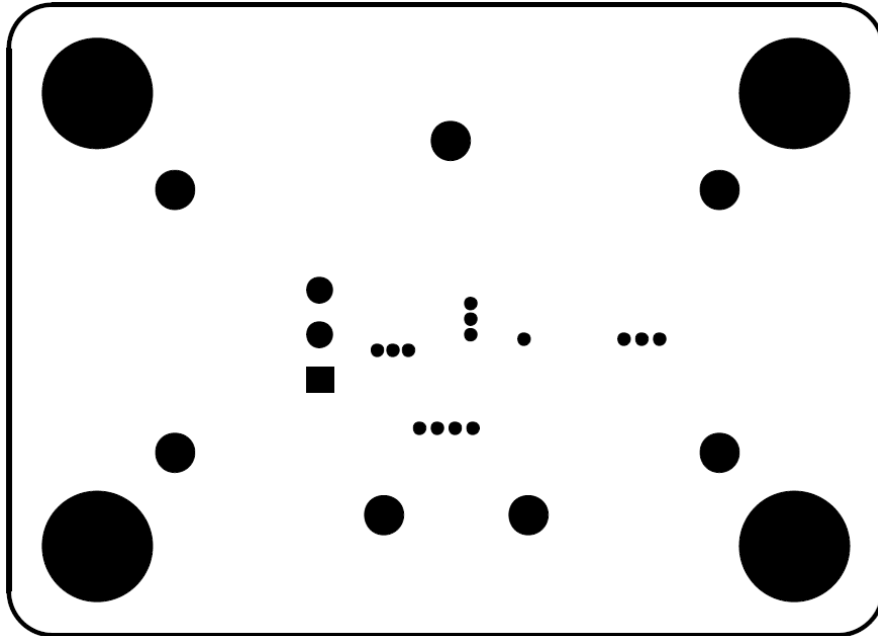

Component Placement Guide—Bottom Side (2nd Layer)

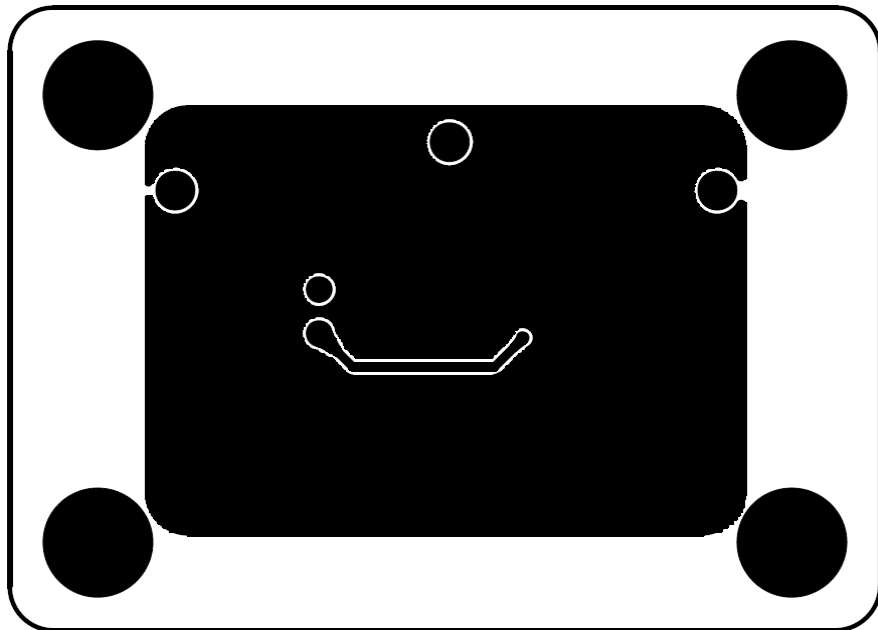

PCB Layout—Bottom Side (2nd layer)

More Information

For more information, please find the related datasheet or application notes from Richtek website <http://www.richtek.com>.

Important Notice for Richtek Evaluation Board

THIS DOCUMENT IS FOR REFERENCE ONLY, NOTHING CONTAINED IN THIS DOCUMENT SHALL BE CONSTRUED AS RICHTEK'S WARRANTY, EXPRESS OR IMPLIED, UNDER CONTRACT, TORT OR STATUTORY, WITH RESPECT TO THE PRESENTATION HEREIN. IN NO EVENT SHALL RICHTEK BE LIABLE TO BUYER OR USER FOR ANY AND ALL DAMAGES INCLUDING WITHOUT LIMITATION TO DIRECT, INDIRECT, SPECIAL, PUNITIVE OR CONSEQUENTIAL DAMAGES.