

DATA SHEET

NTC THERMISTOR
INRUSH CURRENT LIMITER
SP SERIES

RoHS compliant & Halogen free



Product specification— October 26, 2020 V.0



NTC Thermistor SP series Data Sheet

Features

- Effectively restrain surge.
- Low power loss under the stable state.
- Over-current wide control range and fast response.
- Thermal and electrical characteristics with high stability.
- Wide range of electrical specifications.
- RoHS& Halogen Free (HF) compliant.
- Safety certification-UL / TUV

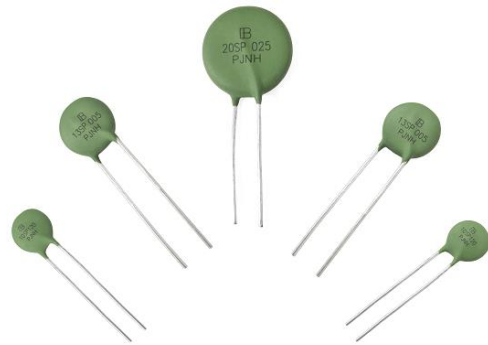

Applications

- Monitor, Sps, Fax, Telecom, Adaptor etc.
- Power supply, Communications equipment etc.

Part Number Code

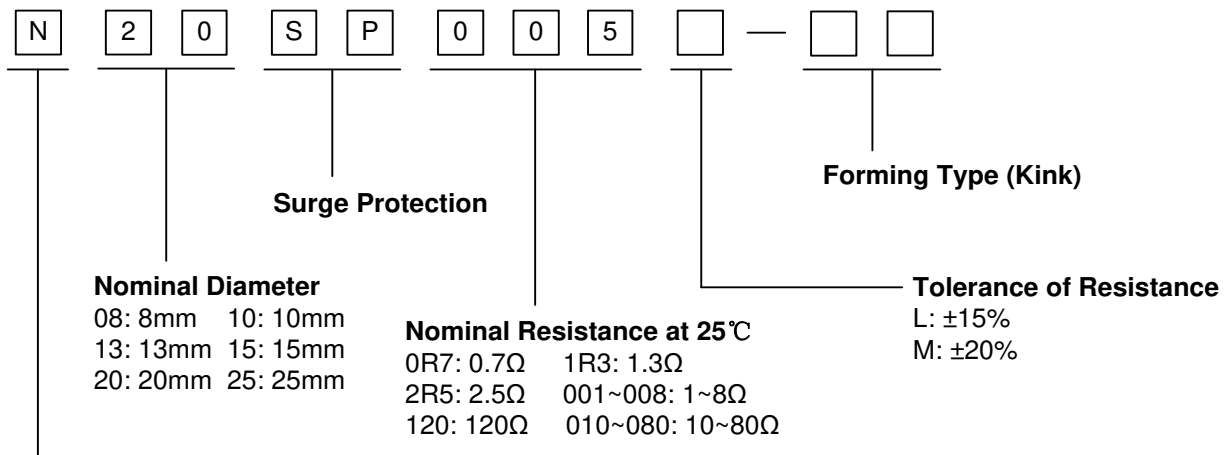

NTC. (Negative Temperature Coefficient)

Marking

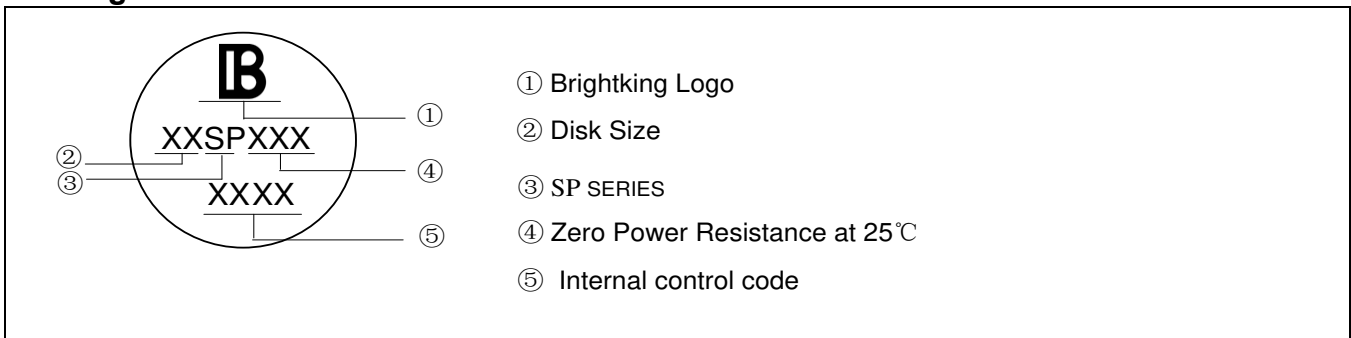

Dimensions (Unit: mm)

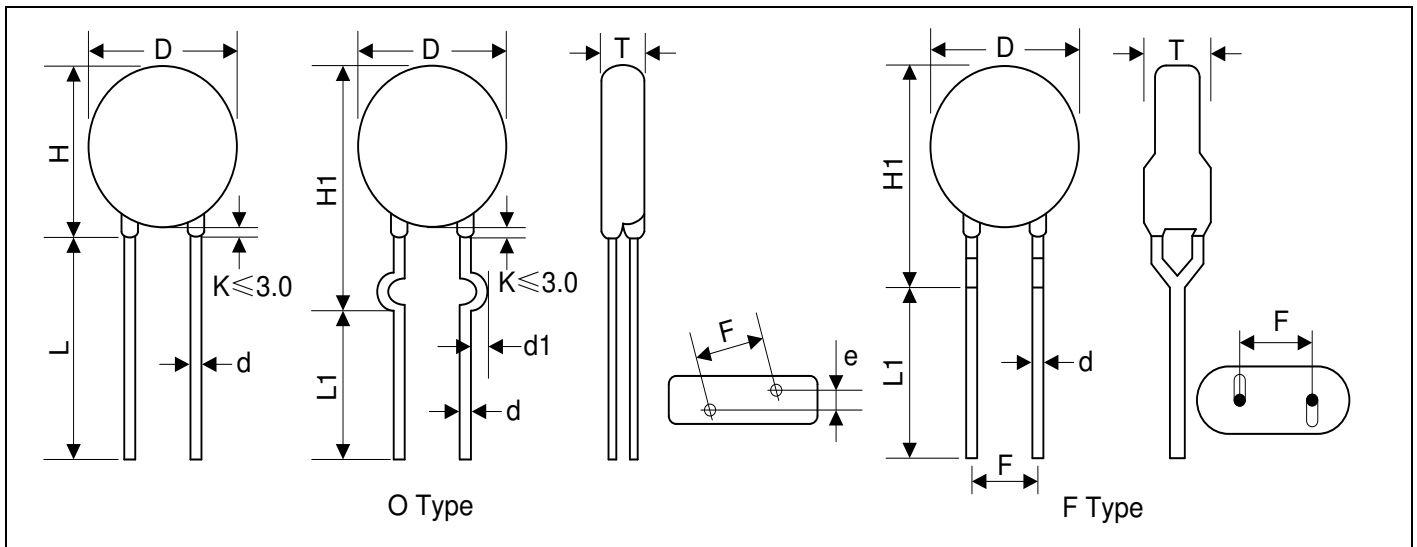

Disc Φ	D (max.)	H (max.)	H1 (max.)	L (Min.)	L1 (Min.)	d (±0.02)	d1 (±0.4)	T (max.)	F (±0.8)	e (±0.5)
08	11.0	13.5	14.0	20.0	15	0.80	1.4	6.0	5.0	2.0
10	13.5	16.0	18.0	20.0	15	0.80	1.4	6.0	5.0	2.1
13	16.0	19.0	22.0	20.0	15	1.00	1.6	6.0	7.5	2.9
15	18.0	21.0	25.0	20.0	15	1.00	1.6	6.5	7.5	3.1
20	24.0	28.0	33.0	20.0	15	1.00	1.6	7.5	7.5	3.6
25	29.0	32.5	38.0	20.0	15	1.00	1.6	7.5	7.5	3.6

Remarks: Straight lead shape is the default lead shape for normal SP series product.

Maximum Power Rating (Pmax)

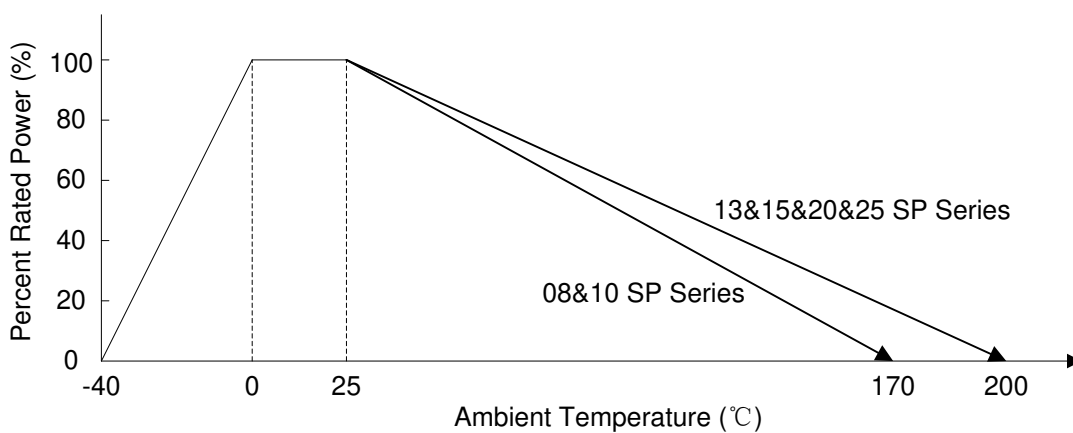

NTC Inrush Current Limiter

SP series

Specifications

Nominal Diameter (mm)	Part Number	Zero Power Resistance at 25°C	Maximum Steady State Current at 25°C	Residual Resistance at 25°C I _{max} R _{I_{max}}	Typical value		Recommend Capacitance 240Vac	Maximum Steady Power	Operating Temperature Range	U _L	T _{UV}
					Thermal Time Constant	Thermal Dissipation Constant					
					(Ω)	(A)					
08	N08SP003□	3	3	0.230	48	12	120	2.0	-40~+170	V	V
	N08SP004□	4	3	0.237	45	12	120	2.0	-40~+170	V	V
	N08SP005□	5	3	0.237	48	9	120	2.0	-40~+170	V	V
	N08SP006□	6	3	0.237	45	9	120	2.0	-40~+170	V	V
	N08SP008□	8	3	0.250	45	9	120	2.0	-40~+170	V	V
	N08SP010□	10	3	0.260	45	9	120	2.0	-40~+170	V	V
	N08SP015□	15	2	0.530	45	12	60	2.0	-40~+170	V	V
	N08SP020□	20	2	0.555	45	12	60	2.0	-40~+170	V	V
	N08SP022□	22	2	0.590	45	12	60	2.0	-40~+170	V	V
	N08SP033□	33	1.5	0.530	45	12	60	2.0	-40~+170	V	V
10	N10SP001□	1	5	0.090	65	17	330	2.5	-40~+170	V	V
	N10SP1R3□	1.3	5	0.090	63	17	330	2.5	-40~+170	V	V
	N10SP1R5□	1.5	5	0.095	60	15	330	2.5	-40~+170	V	V
	N10SP002□	2	5	0.099	55	12	330	2.5	-40~+170	V	V
	N10SP2R5□	2.5	5	0.102	58	11	330	2.5	-40~+170	V	V
	N10SP003□	3	5	0.106	60	11	330	2.5	-40~+170	V	V
	N10SP004□	4	4	0.163	62	10	330	2.5	-40~+170	V	V
	N10SP005□	5	4	0.168	58	10	330	2.5	-40~+170	V	V
	N10SP006□	6	3	0.250	59	10	220	2.5	-40~+170	V	V
	N10SP007□	7	3	0.262	60	13	220	2.5	-40~+170	V	V
	N10SP008□	8	3	0.265	59	12	220	2.5	-40~+170	V	V
	N10SP010□	10	3	0.273	56	12	220	2.5	-40~+170	V	V
	N10SP012□	12	2	0.504	58	11	220	2.5	-40~+170	V	V
	N10SP015□	15	2	0.500	62	11	220	2.5	-40~+170	V	V
	N10SP016□	16	2	0.501	62	11	220	2.5	-40~+170	V	V
	N10SP020□	20	2	0.557	60	12	220	2.5	-40~+170	V	V
	N10SP025□	25	2	0.555	56	12	220	2.5	-40~+170	V	V
	N10SP050□	50	2	0.723	58	10	220	2.5	-40~+170	V	V
N10SP080□	80	1	1.742	55	10	150	2.5	-40~+170	V	V	
N10SP120□	120	1	2.355	60	10	150	2.5	-40~+170	V	V	
N10SP150□	150	1	2.500	55	10	150	2.5	-40~+170	V	V	

NTC Inrush Current Limiter

SP series

Nominal Diameter (mm)	Part Number	Zero Power Resistance at 25°C	Maximum Steady State Current at 25°C	Residual Resistance at 25°C I _{max} R _{lmax}	Typical value		Recommend Capacitance 240Vac	Maximum Steady Power	Operating Temperature Range	U _L	T _{UV}
					Thermal Time Constant	Thermal Dissipation Constant					
					(s)	(mW/°C)					
		(Ω)	(A)	(Ω)	(s)	(mW/°C)	(μF)	(W)	(°C)		
13	N13SP1R3□	1.3	7	0.065	91	15	430	3.0	-40~+200	V	V
	N13SP1R5□	1.5	7	0.083	90	15	430	3.0	-40~+200	V	V
	N13SP2R5□	2.5	6	0.094	85	16	430	3.0	-40~+200	V	V
	N13SP003□	3	5	0.131	93	16	430	3.0	-40~+200	V	V
	N13SP004□	4	5	0.139	91	16	430	3.0	-40~+200	V	V
	N13SP005□	5	5	0.150	93	17	430	3.0	-40~+200	V	V
	N13SP006□	6	5	0.250	92	16	430	3.0	-40~+200	V	V
	N13SP007□	7	5	0.262	91	16	430	3.0	-40~+200	V	V
	N13SP008□	8	4	0.207	91	15	430	3.0	-40~+200	V	V
	N13SP010□	10	4	0.211	87	14	430	3.0	-40~+200	V	V
	N13SP012□	12	4	0.227	82	18	330	3.0	-40~+200	V	V
	N13SP016□	16	3	0.367	87	15	330	3.0	-40~+200	V	V
	N13SP018□	18	3	0.391	90	17	330	3.0	-40~+200	V	V
	N13SP020□	20	3	0.430	93	17	330	3.0	-40~+200	V	V
N13SP025□	25	3	0.430	93	17	330	3.0	-40~+200	V	V	
15	N15SP1R3□	1.3	8	0.059	107	20	640	4.0	-40~+200	V	V
	N15SP1R5□	1.5	8	0.064	107	19	640	4.0	-40~+200	V	V
	N15SP2R5□	2.5	8	0.070	104	20	640	4.0	-40~+200	V	V
	N15SP003□	3	7	0.089	105	20	640	4.0	-40~+200	V	V
	N15SP004□	4	6	0.115	104	18	640	4.0	-40~+200	V	V
	N15SP005□	5	6	0.122	110	20	640	4.0	-40~+200	V	V
	N15SP006□	6	5	0.160	102	20	640	4.0	-40~+200	V	V
	N15SP007□	7	5	0.188	99	21	640	4.0	-40~+200	V	V
	N15SP008□	8	5	0.186	103	15	640	4.0	-40~+200	V	V
	N15SP010□	10	5	0.182	103	19	640	4.0	-40~+200	V	V
	N15SP012□	12	4	0.252	102	21	560	4.0	-40~+200	V	V
	N15SP015□	15	4	0.260	101	17	560	4.0	-40~+200	V	V
	N15SP016□	16	4	0.285	102	22	560	4.0	-40~+200	V	V
	N15SP020□	20	4	0.292	101	20	560	4.0	-40~+200	V	V
	N15SP022□	22	4	0.302	101	20	560	4.0	-40~+200	V	V
	N15SP025□	25	3	0.482	100	21	560	4.0	-40~+200	V	V
	N15SP033□	33	3	0.490	100	21	560	4.0	-40~+200	V	V
	N15SP040□	40	3	0.496	101	20	560	4.0	-40~+200	V	V
N15SP047□	47	3	0.517	102	21	560	4.0	-40~+200	V	V	
N15SP055□	55	3	0.534	102	21	560	4.0	-40~+200	V	V	
N15SP080□	80	2.5	0.748	102	22	560	4.0	-40~+200	V	V	
N15SP120□	120	2	1.159	104	20	560	4.0	-40~+200	V	V	

NTC Inrush Current Limiter

SP series

Nominal Diameter (mm)	Part Number	Zero Power Resistance at 25°C	Maximum Steady State Current at 25°C	Residual Resistance at 25°C I _{max} R _{lmax}	Typical value		Recommend Capacitance 240Vac	Maximum Steady Power	Operating Temperature Range	UL	TUV
					Thermal Time Constant	Thermal Dissipation Constant					
					(s)	(mW/°C)					
		(Ω)	(A)	(Ω)	(s)	(mW/°C)	(μF)	(W)	(°C)		
20	N20SP0R7□	0.7	12	0.039	145	25	820	5.0	-40~+200	V	V
	N20SP001□	1	10	0.051	135	25	820	5.0	-40~+200	V	V
	N20SP1R3□	1.3	8	0.064	144	24	820	5.0	-40~+200	V	V
	N20SP002□	2	8	0.072	140	21	820	5.0	-40~+200	V	V
	N20SP2R5□	2.5	8	0.073	120	23	820	5.0	-40~+200	V	V
	N20SP004□	4	8	0.087	135	25	820	5.0	-40~+200	V	V
	N20SP005□	5	7	0.107	144	24	820	5.0	-40~+200	V	V
	N20SP006□	6	6	0.156	136	24	820	5.0	-40~+200	V	V
	N20SP007□	7	6	0.156	132	24	820	5.0	-40~+200	V	V
	N20SP008□	8	6	0.157	135	24	820	5.0	-40~+200	V	
	N20SP010□	10	6	0.158	135	23	820	5.0	-40~+200	V	V
	N20SP012□	12	5	0.205	132	25	820	5.0	-40~+200	V	V
	N20SP020□	20	6	0.197	127	22	740	5.0	-40~+200	V	V
	N20SP025□	25	6	0.197	127	22	740	5.0	-40~+200	V	V
	N20SP120□	120	2	1.222	142	24	740	5.0	-40~+200	V	V
25	N25SP001□	1	15	0.037	150	30	1240	6.5	-40~+200	V	V
	N25SP1R5□	1.5	15	0.036	150	30	1240	6.5	-40~+200	V	V
	N25SP002□	2	15	0.049	150	30	1240	6.5	-40~+200	V	V
	N25SP2R5□	2.5	15	0.051	150	30	1240	6.5	-40~+200	V	V
	N25SP003□	3	15	0.059	150	30	1240	6.5	-40~+200	V	V
	N25SP004□	4	14	0.054	150	30	1240	6.5	-40~+200	V	V
	N25SP4R7□	4.7	13	0.043	150	30	1240	6.5	-40~+200	V	V
	N25SP005□	5	12	0.066	150	30	1240	6.5	-40~+200	V	V
	N25SP6R8□	6.8	10.5	0.073	150	30	820	6.5	-40~+200	V	V
	N25SP007□	7	10	0.079	150	30	820	6.5	-40~+200	V	V
	N25SP008□	8	9	0.095	150	30	820	6.5	-40~+200	V	V
	N25SP010□	10	8	0.118	150	30	820	6.5	-40~+200	V	V
	N25SP012□	12	7.5	0.132	150	30	820	6.5	-40~+200	V	V
	N25SP015□	15	6.5	0.186	150	30	740	6.5	-40~+200	V	V
	N25SP018□	18	5.5	0.237	150	30	740	6.5	-40~+200	V	V
N25SP020□	20	5	0.237	150	30	740	6.5	-40~+200	V	V	

□ means tolerance of R25 , L: ± 15%, M: ± 20%,

Reliability Test Requirements

Test items Reference standard	Test conditions		Criterion
High Temperature Storage IEC 60068-2-2	T _U ±5℃, 1000±24hrs		No visible damage ΔR25/R25 ≦ 20%
Damp Heat, Steady State IEC 60068-2-78	40±2℃,90~95%RH , 1000±24hrs		No visible damage ΔR25/R25 ≦ 20%
Endurance IEC 60539-1	25±5℃ , I _{max} .1000±24hrs		No visible damage ΔR25/R25 ≦ 20%
Rapid Change of Temperature IEC 60068-2-14	Step	Temperature (℃)	No visible damage ΔR25/R25 ≦ 20%
	1	T _L ± 5	
	2	Room	
	3	T _U ± 5	
	4	Room	
5 Cycles			
Capacitance test standard specifications	25±5℃ , C _{th} , interval 2mins, , Number of cycles: 1000, C _{th} =Capacitance at 340 VDC		No visible damage ΔR25/R25 ≦ 20%
Cyclic endurance IEC 60539-1	25±5℃,I _{max} .1min ON/5min OFF*1000cycles;		No visible damage ΔR25/R25 ≦ 20%
Insulation Test MIL-STD-202F-Method 302	1000 VDC,1min		No visible damage
Tensile Strength of Terminals IEC 60068-2-21	Gradually applying the force specified and keeping the unit fixed for 10±1 sec.		No visible damage ΔR25/R25 ≦ 10 %
	Terminal diameter (mm)	Force (kg)	
	0.5<d ≦ 0.8	1.0	
	0.8<d ≦ 1.25	2.0	
Bending Strength of Terminals IEC60068-2-21	Follow spec: Hold specimen and apply the force specified below to each lead. Bend the specimen to 90°, then return to the original position. Repeat the procedure in the opposite direction.		No visible damage ΔV/V1mA ≦ 5%
	Terminal diameter (mm)	Force (kg)	
	0.5<d ≦ 0.8	0.5	
	0.8<d ≦ 1.25	1.0	
	1.25<d	2.0	
Solderability IEC 60068-2-20	245 ± 3 ℃ , 3 ± 0.3 sec		≧ 95%
Resistance to Soldering Heat IEC 60068-2-20	260 ± 3 ℃ ,10 ± 1 sec		ΔR/R ≦ 5 %

Resistance–Temperature Characteristic Curves

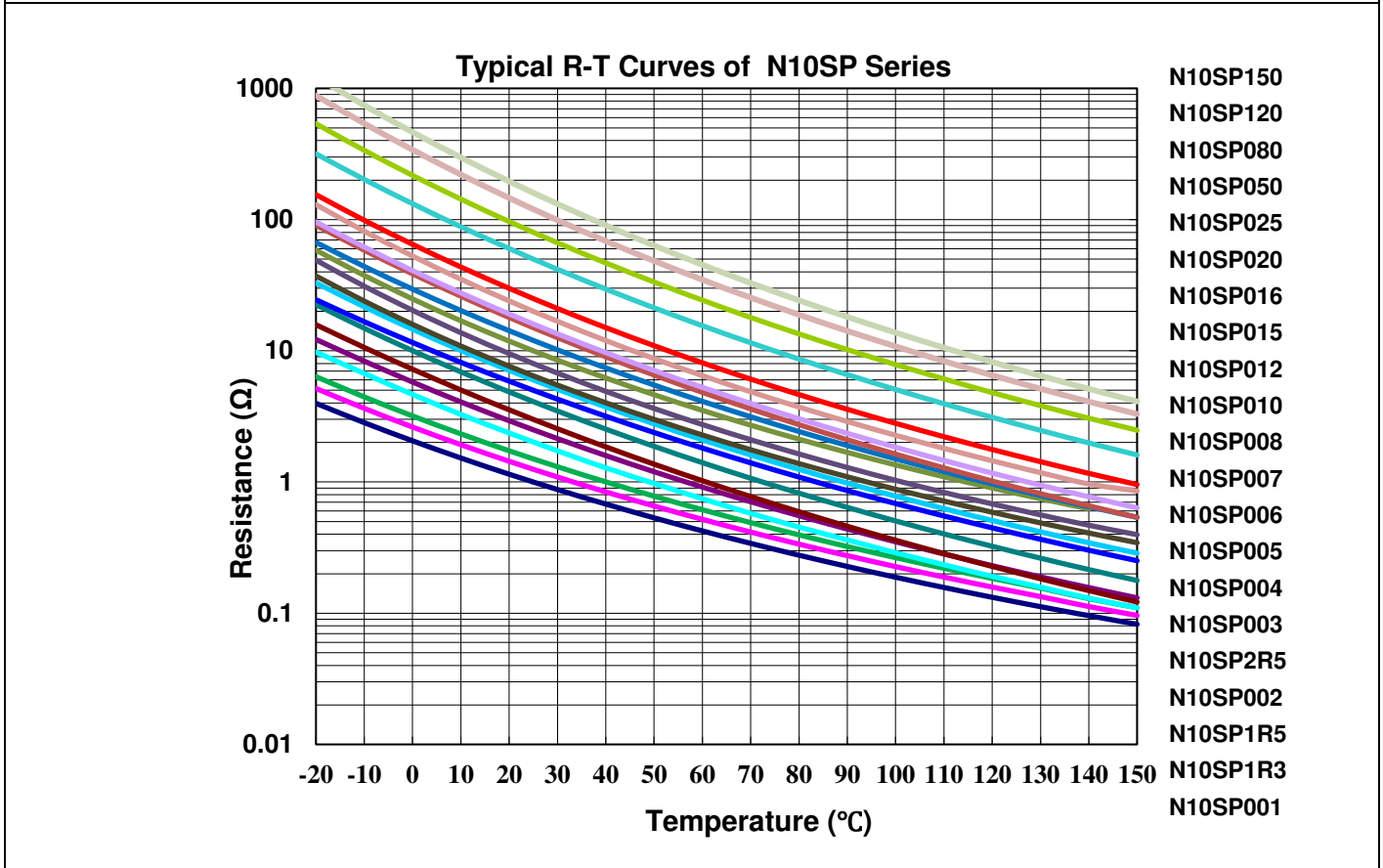
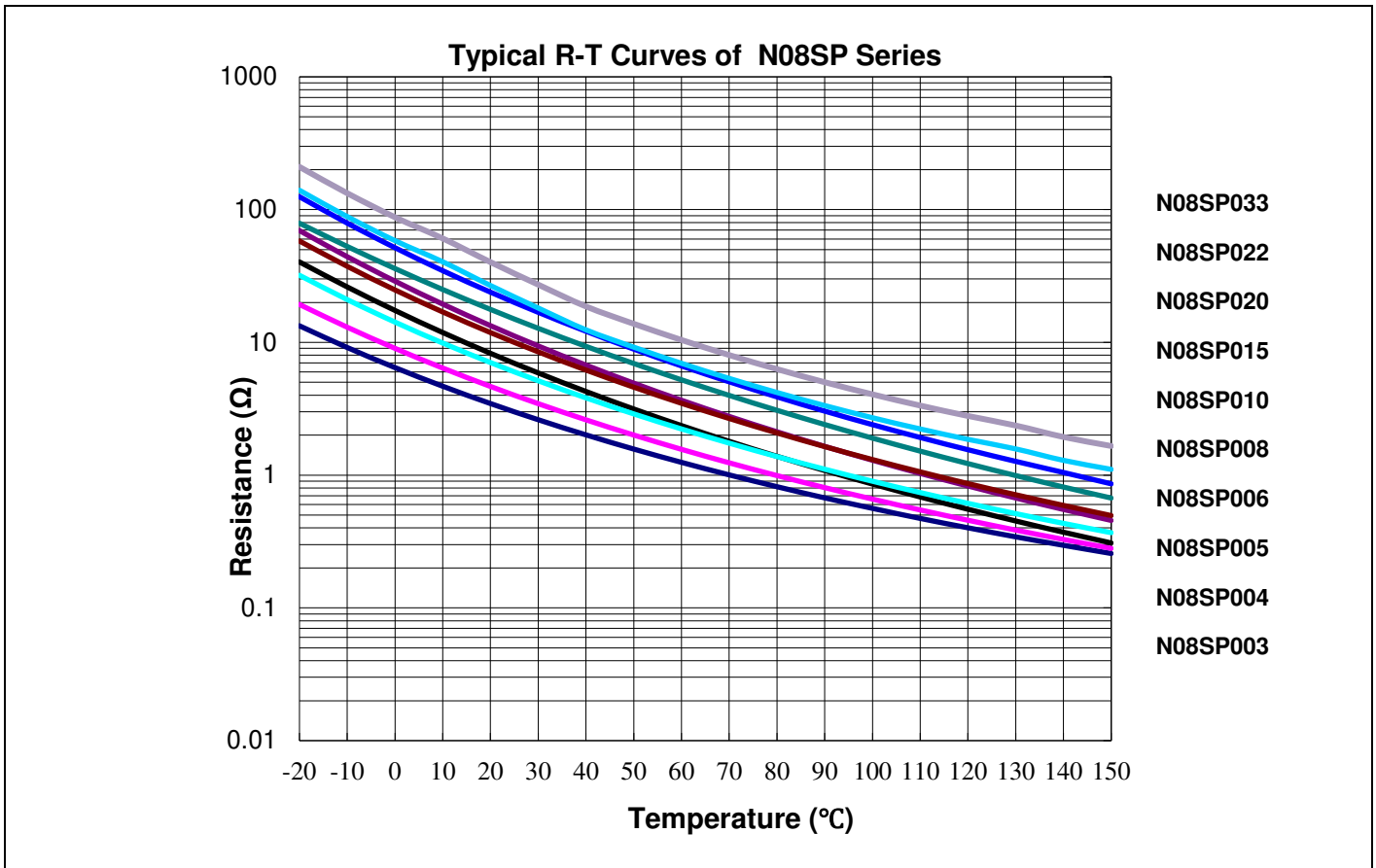

Resistance–Temperature Characteristic Curves

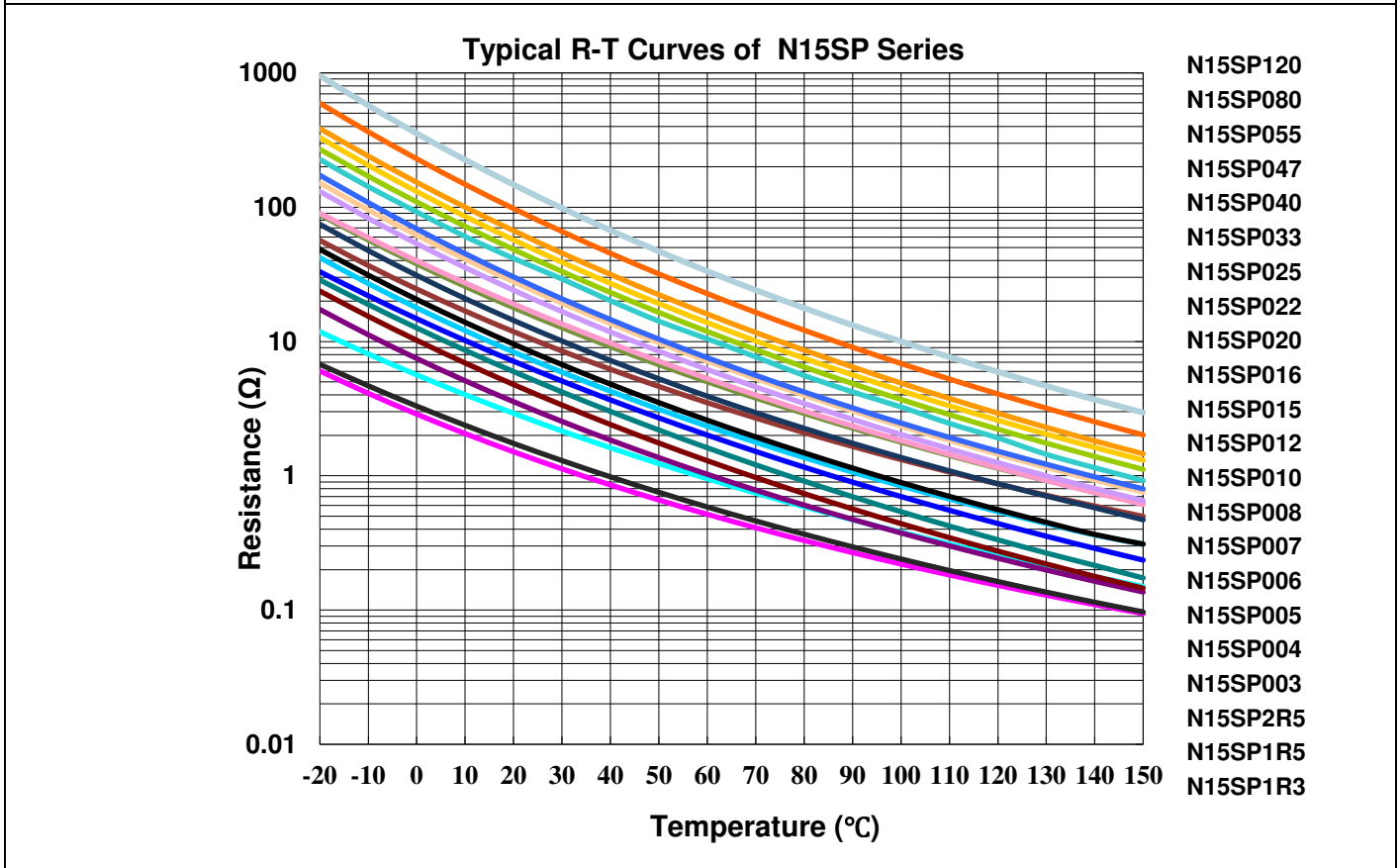
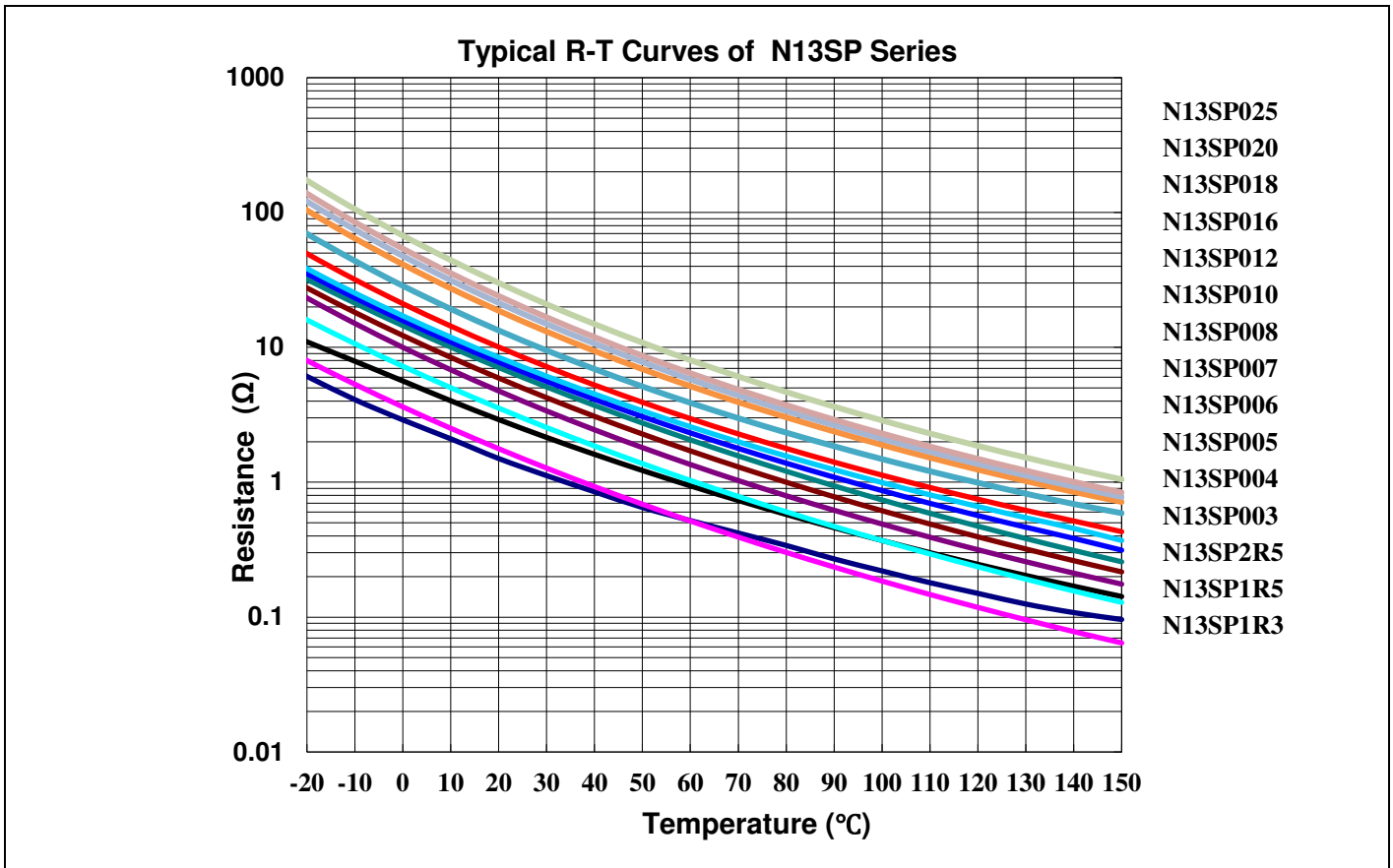

Resistance–Temperature Characteristic Curves

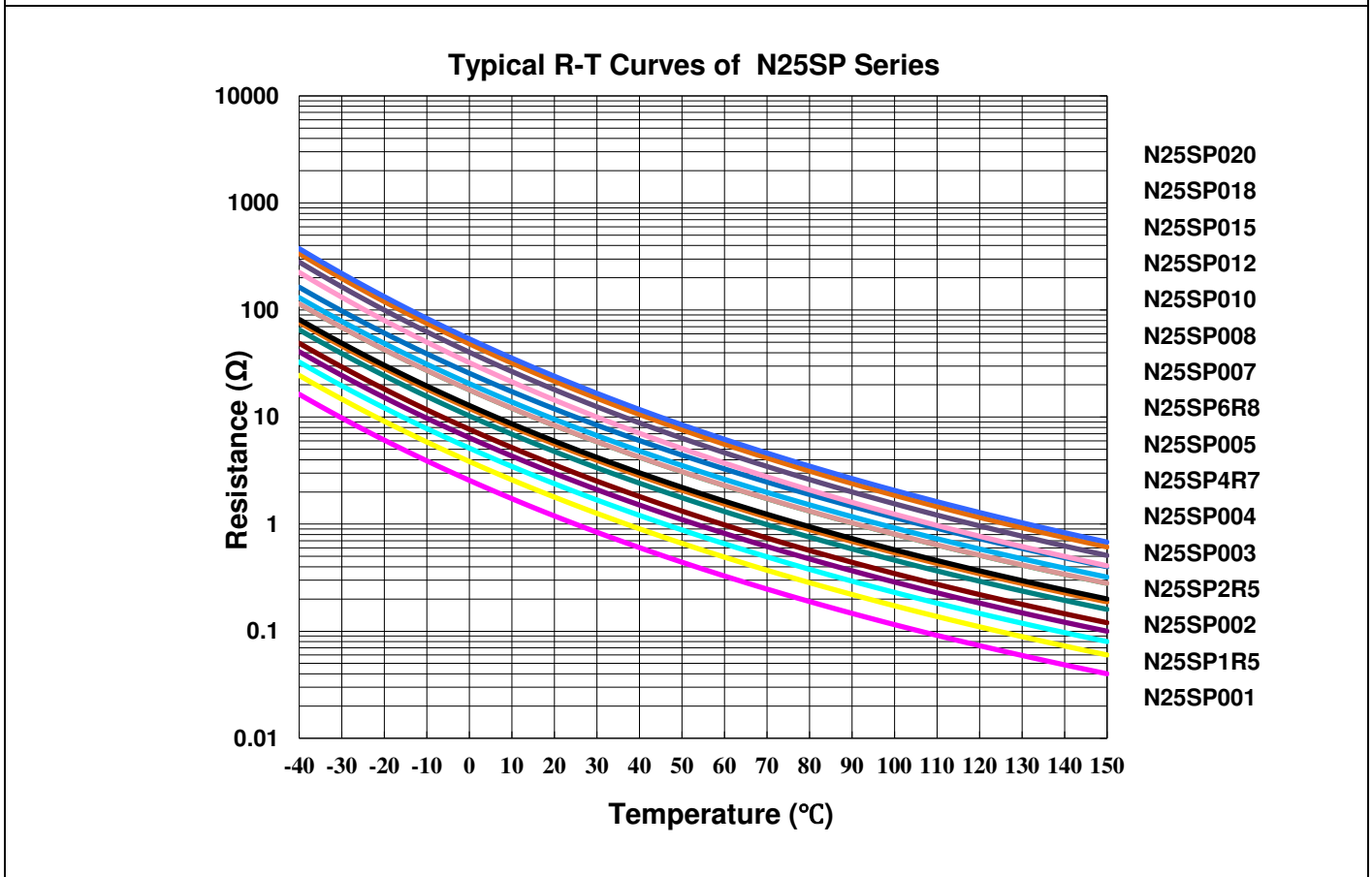
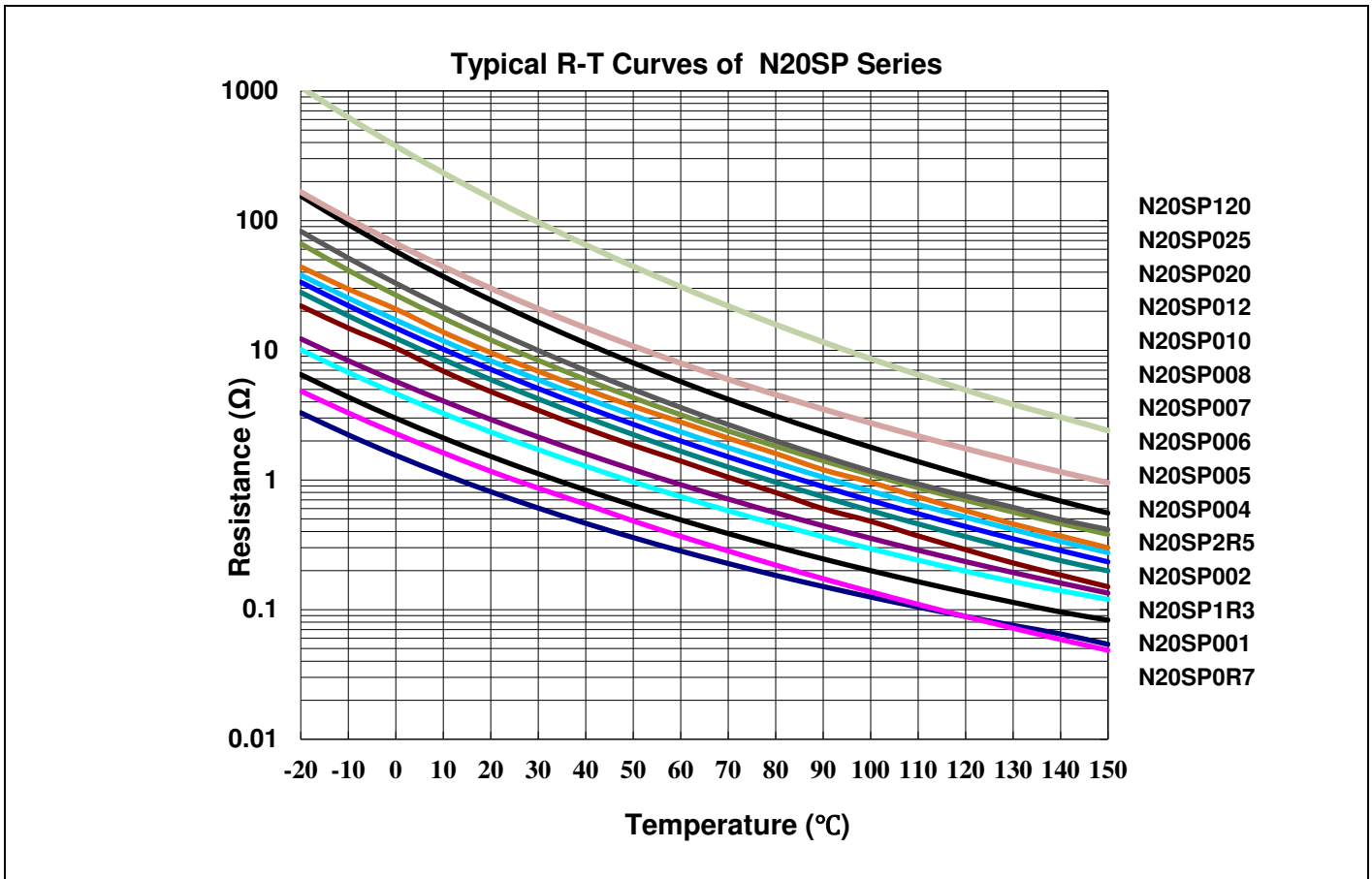

V-I Characteristic Curves

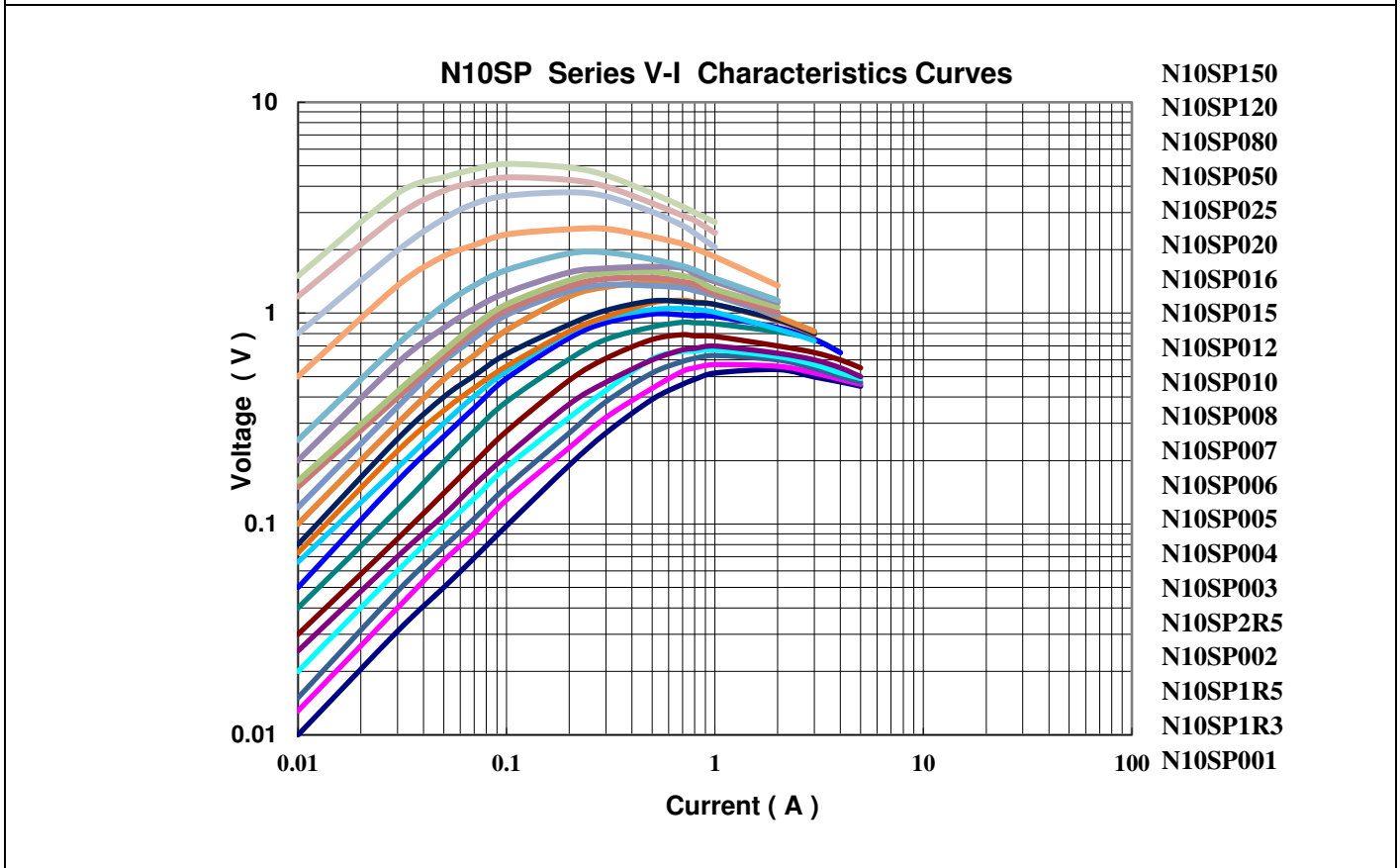
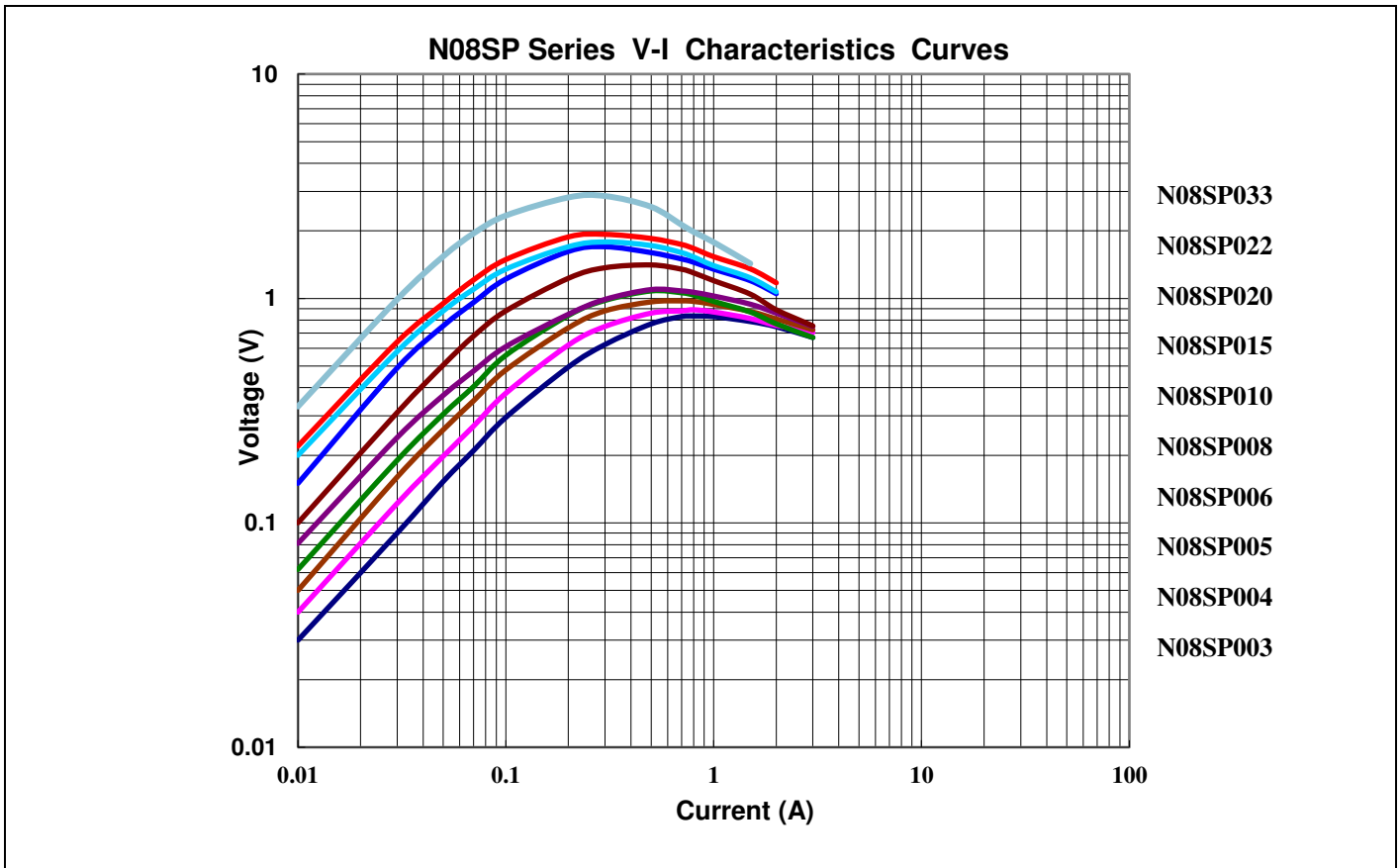

V-I Characteristic Curves

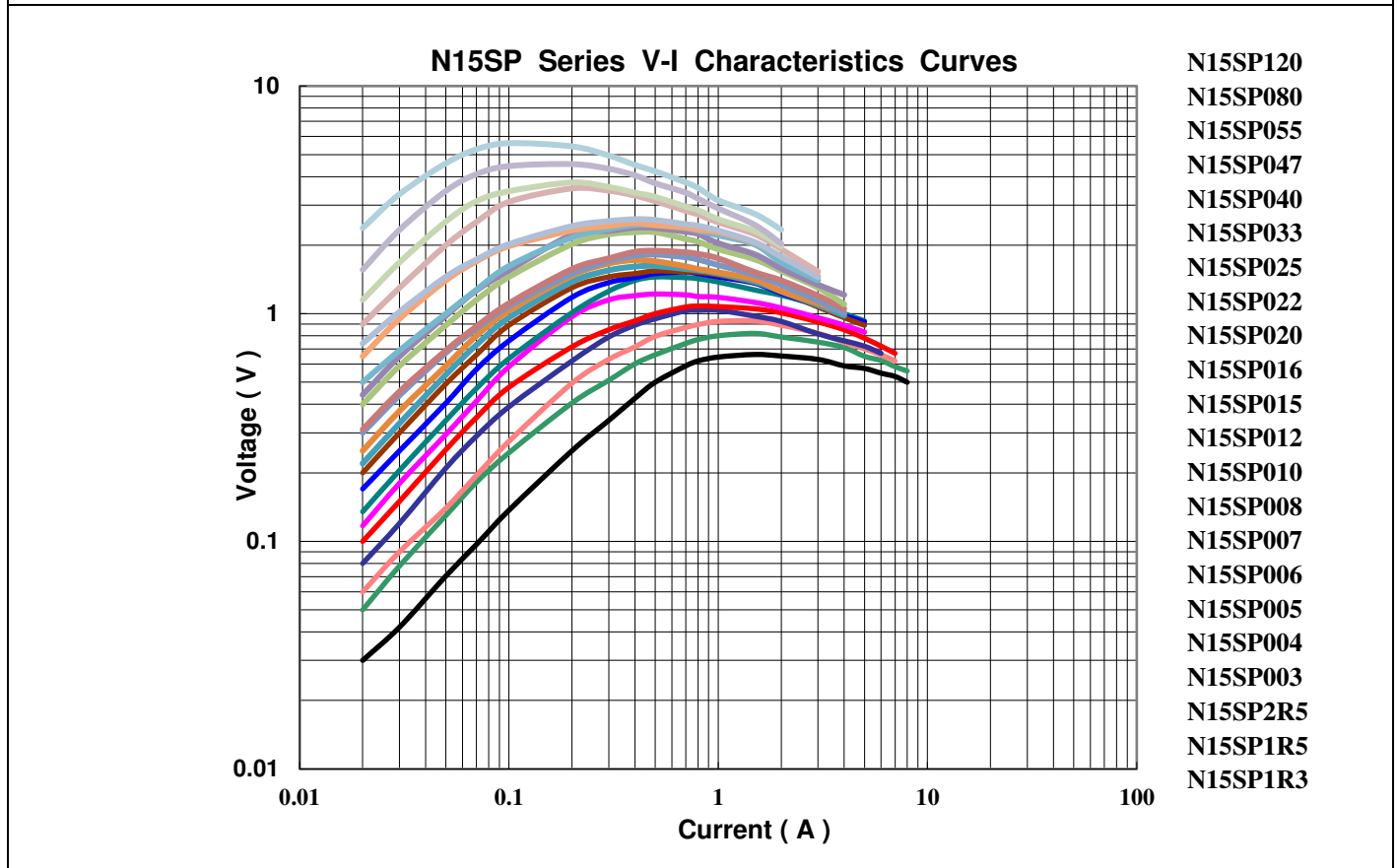
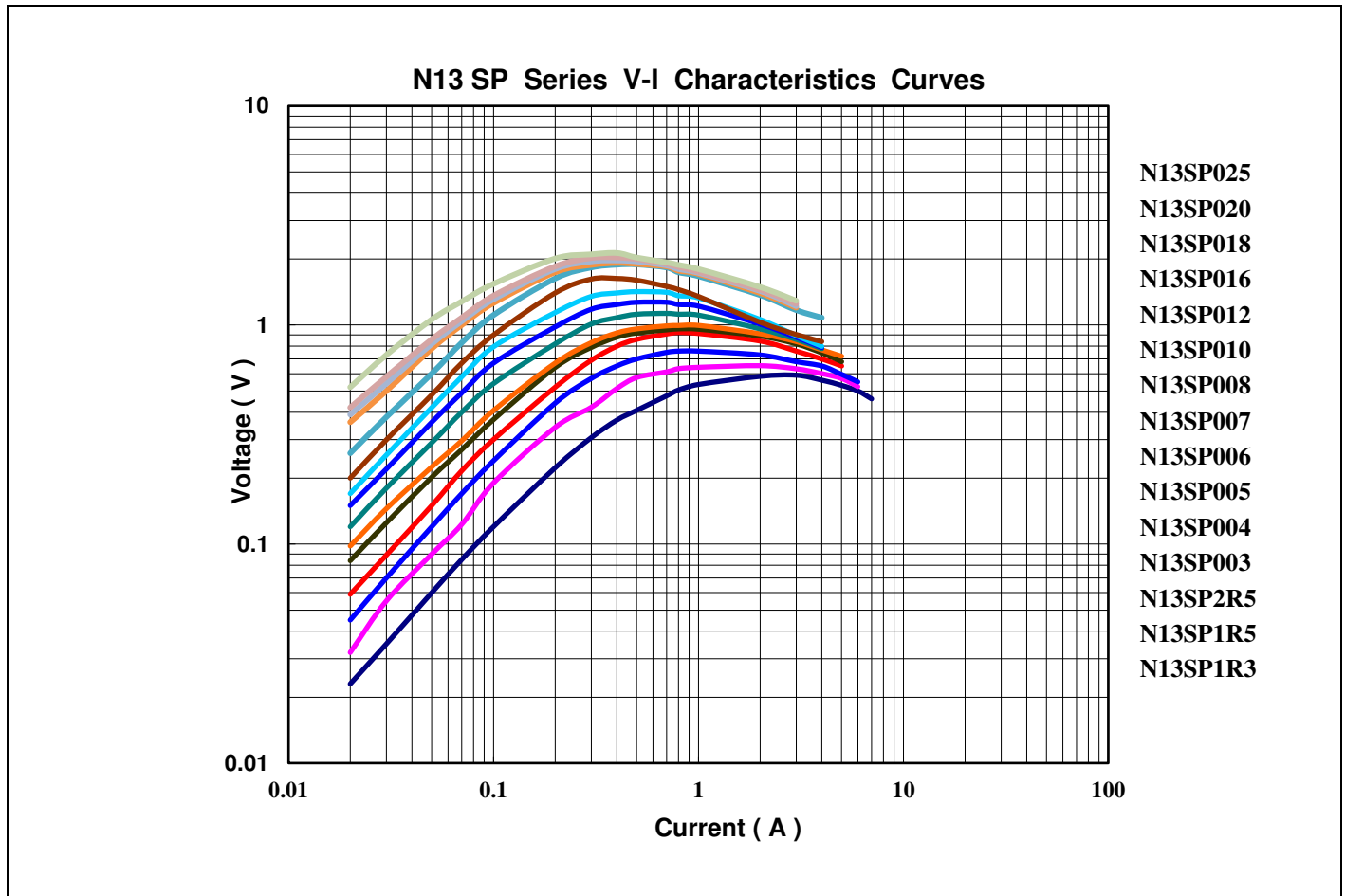

V-I Characteristic Curves

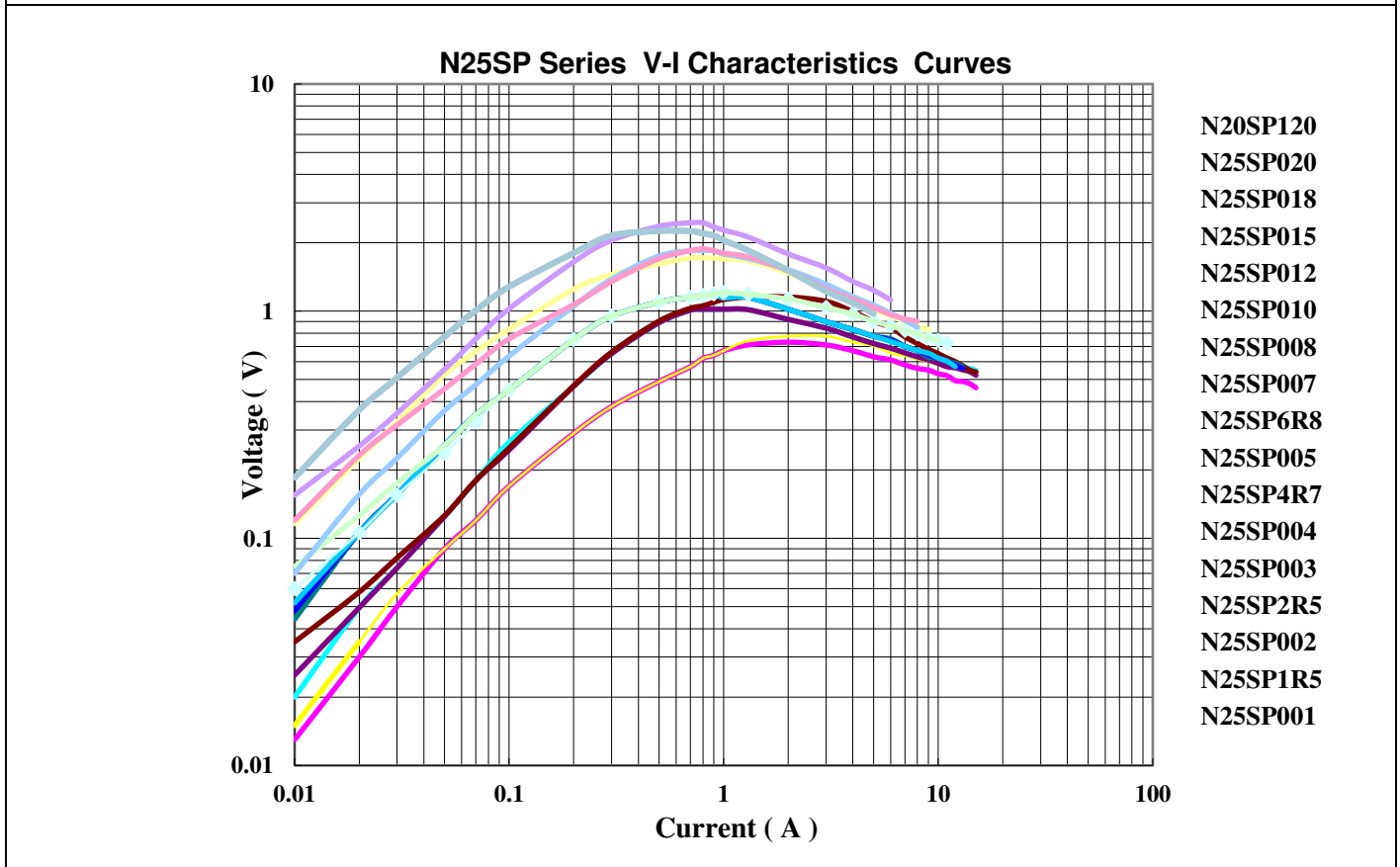
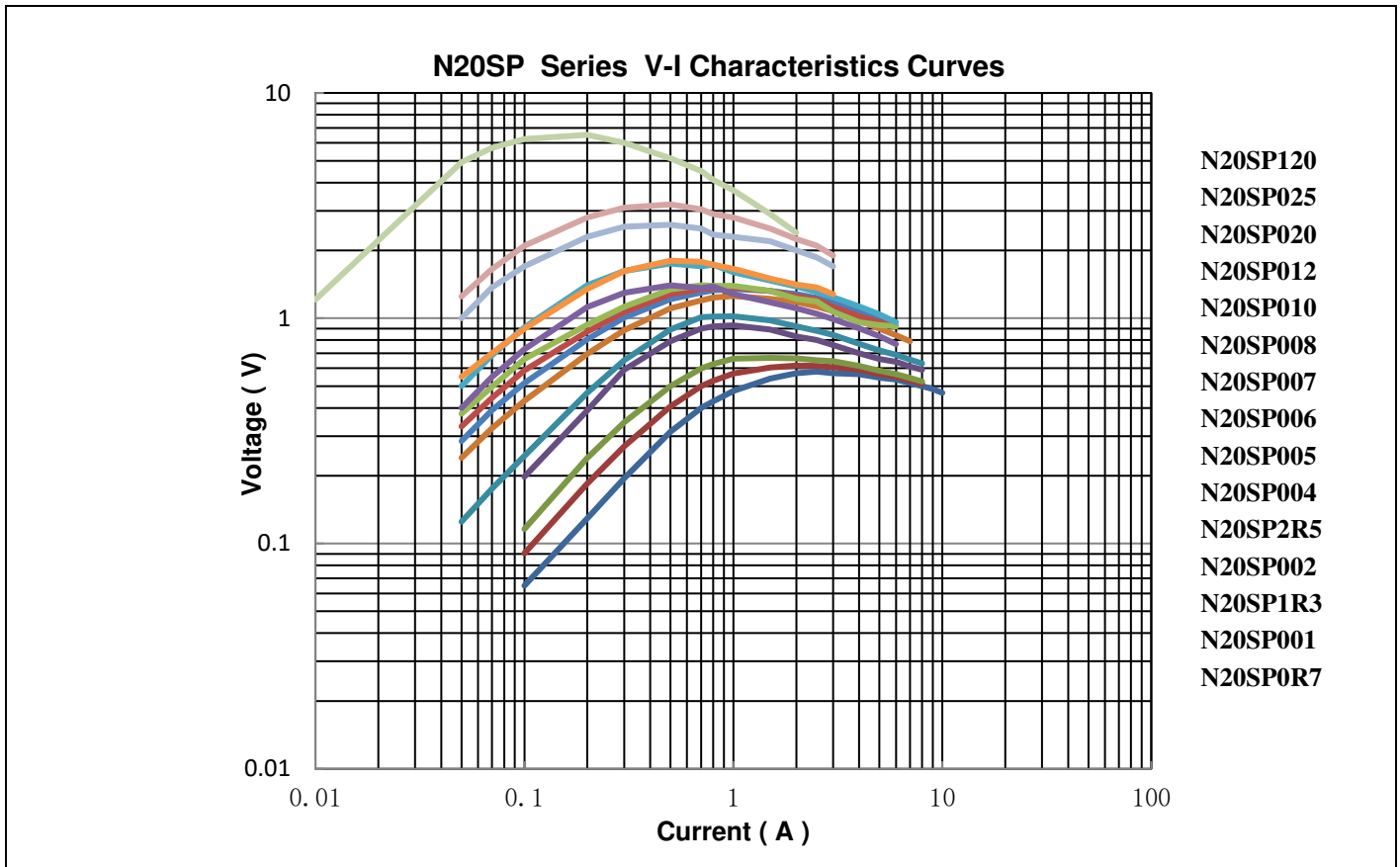

Soldering Recommendation

Wave Soldering Recommendation

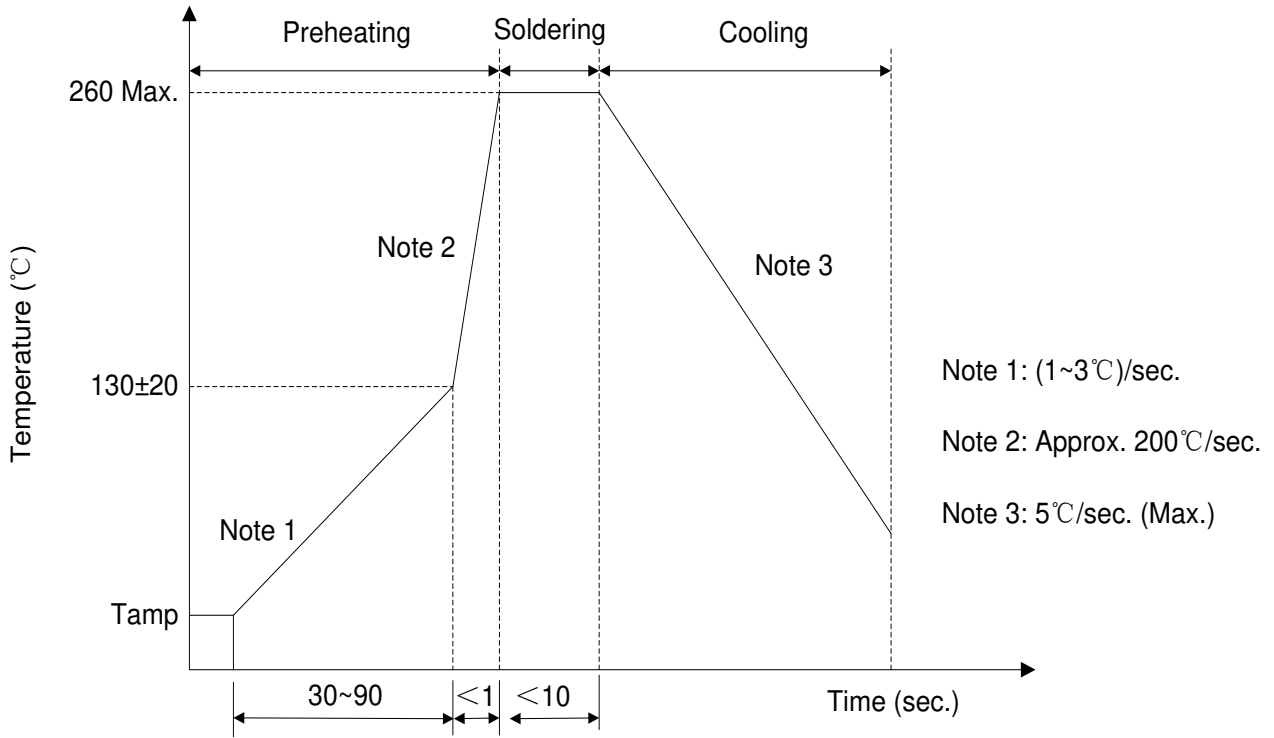

Recommended Reworking Conditions with Soldering Iron

Item	Conditions
Temperature of Soldering Iron-tip	360°C(max.)
Soldering Time	3 seconds(max.)
Distance from Thermistor	2mm (min.)

Packaging

■ Taping Packing

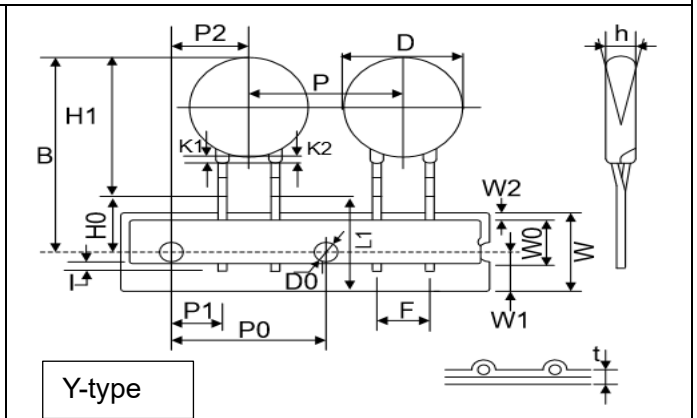
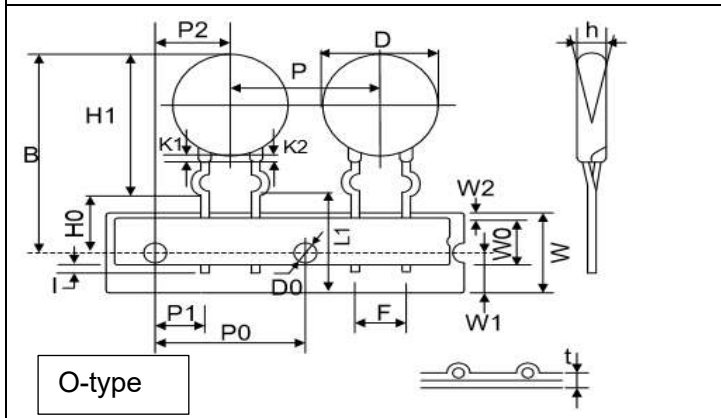
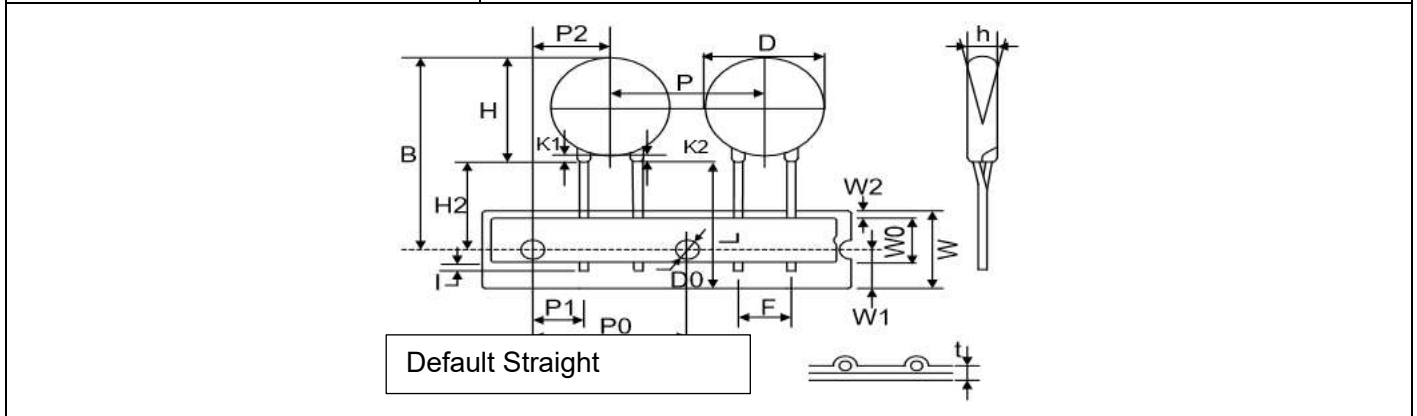
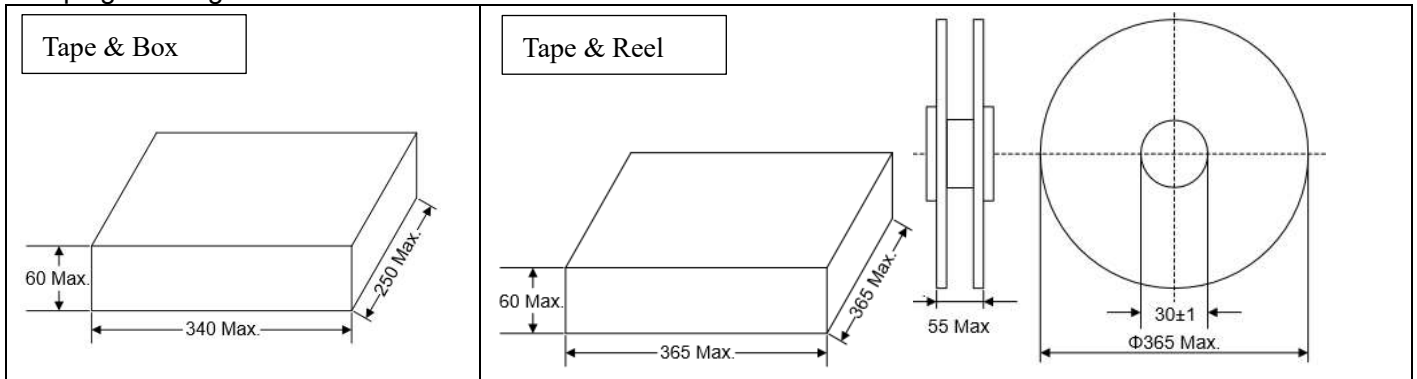

Dimensions	W	W0	W1	W2	H0	H2	D0	t	l
(Unit: mm)	18.0 ±1.0	10.0 ±1.0	9.0 +0.5/-0	Max 3.0	16.0 ±1.0	20.0 ±2.0	4.0 ±0.2	0.6 ±0.1	Max 2
Disc Φ	P0	P1 (±0.7)	P2 (+1.3/-0)	P (+1.0)	H (±1.0)	B (Max)		SPQ P0: 12.7mm	
								Taping & Box	Taping & Reel
8	12.7±0.3	3.85	6.35	12.7	0±2	33		1500pcs/Box	1500pcs/Box
10	12.7±0.3	3.85	6.35	25.4	0±2	36		500pcs/Box	600pcs/Box
13	12.7±1.0	8.95	12.7	25.4	0±4	40		500pcs/Box	600pcs/Box
15	12.7±1.0	8.95	12.7	25.4	0±4	42		500pcs/Box	600pcs/Box
20	/	/	/	/	/	/		/	/
25	/	/	/	/	/	/		/	/

■ Bulk Packing

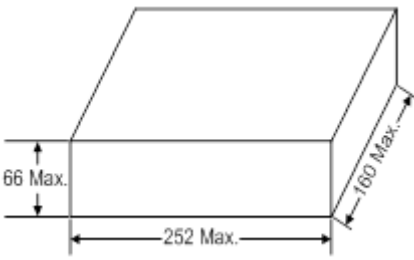
Bulk (Unit: mm)	Disc Φ	SPQ (pcs / Bag)	Quantity	
			(Bags / Box)	(pcs / Box)
	Φ08	500	2	1000
	Φ10	500	2	1000
	Φ13	300	2	600
	Φ15	125	4	500
	Φ20	75	4	300
	Φ25	25	4	100

Warehouse Storage Conditions

- Storage temperature: -10°C~+40°C.
- Relative humidity: ≤80%RH.
- Keep away from corrosive atmosphere and sunlight.
- Period of Storage: 1 year.

LEGAL DISCLAIMER

YAGEO, its distributors and agents (collectively, "YAGEO"), hereby disclaims any and all liabilities for any errors, inaccuracies or incompleteness contained in any product related information, including but not limited to product specifications, datasheets, pictures and/or graphics. YAGEO may make changes, modifications and/or improvements to product related information at any time and without notice.

YAGEO makes no representation, warranty, and/or guarantee about the fitness of its products for any particular purpose or the continuing production of any of its products. To the maximum extent permitted by law, YAGEO disclaims (i) any and all liability arising out of the application or use of any YAGEO product, (ii) any and all liability, including without limitation special, consequential or incidental damages, and (iii) any and all implied warranties, including warranties of fitness for a particular purpose, non-infringement and merchantability.

YAGEO products are designed for general purpose applications under normal operation and usage conditions. Please contact YAGEO for the applications listed below which require especially high reliability for the prevention of defects which might directly cause damage to the third party's life, body or property: Aerospace equipment (artificial satellite, rocket, etc.), Atomic energy-related equipment, Aviation equipment, Disaster prevention equipment, crime prevention equipment, Electric heating apparatus, burning equipment, Highly public information network equipment, data-processing equipment, Medical devices, Military equipment, Power generation control equipment, Safety equipment, Traffic signal equipment, Transportation equipment and Undersea equipment, or for any other application or use in which the failure of YAGEO products could result in personal injury or death, or serious property damage. Particularly **YAGEO Corporation and its affiliates do not recommend the use of commercial or automotive grade products for high reliability applications or manned space flight.**

Information provided here is intended to indicate product specifications only. YAGEO reserves all the rights for revising this content without further notification, as long as products are unchanged. Any product change will be announced by PCN.