

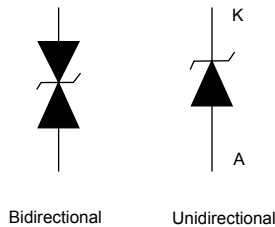

Automotive 600 W TVS in SMB



Features

- AEC-Q101 qualified 
- Peak pulse power: 600 W (10/1000 μ s) and 4 kW (8/20 μ s)
- Stand-off voltage range from 5 V to 188 V
- Unidirectional and bidirectional types
- Low leakage current: 0.2 μ A at 25 °C and 1 μ A at 85 °C
- Operating T_j max: 150 °C
- High power capability at T_j max.: up to 515 W (10/1000 μ s)
- Lead finishing: matte tin plating

Complies with the following standards

- UL94, V0
- J-STD-020 MSL level 1
- J-STD-002, JESD 22-B102 E3 and MIL-STD-750, method 2026 solderable matte tin plated leads
- JESD-201 class 2 whisker test
- IPC7531 footprint
- JEDEC registered package outline
- IEC 61000-4-4 level 4:
 - 4 kV
- ISO10605, IEC 61000-4-2, C= 150 pF - R = 330 Ω exceeds level 4:
 - 30 kV (air discharge)
 - 30 kV (contact discharge)
- ISO10605 - C = 330 pF, R = 330 Ω exceeds level 4:
 - 30 kV (air discharge)
 - 30 kV (contact discharge)
- ISO7637-2 (Not applicable to parts with stand-off voltage lower than battery voltage)
 - Pulse1: $V_S = -150$ V
 - Pulse 2a: $V_S = +112$ V
 - Pulse 3a: $V_S = -220$ V
 - Pulse 3b: $V_S = +150$ V

Description

The SM6TY series are designed to protect sensitive automotive circuits against surges defined in ISO 7637-2 and against electrostatic discharges according to ISO 10605.

The Planar technology makes it compatible with high-end circuits where low leakage current and high junction temperature are required to provide long term reliability and stability.

| Product status link | |
|---------------------|---|
| SM6TY | SM6T6V8AY , SM6T6V8CAY , SM6T7V5AY , SM6T7V5CAY , SM6T10AY , SM6T10CAY , SM6T12AY , SM6T12CAY , SM6T15AY , SM6T15CAY , SM6T16V5AY , SM6T16V5CAY , SM6T18AY , SM6T18CAY , SM6T22AY , SM6T22CAY , SM6T24AY , SM6T24CAY , SM6T27AY , SM6T27CAY , SM6T30AY , SM6T30CAY , SM6T33AY , SM6T33CAY , SM6T36AY , SM6T36CAY , SM6T39AY , SM6T39CAY , SM6T42AY , SM6T42CAY , SM6T47AY , SM6T47CAY , SM6T56AY , SM6T56CAY , SM6T68AY , SM6T68CAY , SM6T75AY , SM6T75CAY , SM6T82AY , SM6T82CAY |

1 Characteristics

Table 1. Absolute maximum ratings ($T_{amb} = 25\text{ }^{\circ}\text{C}$)

| Symbol | Parameter | Value | Unit | |
|-----------|--|--|--------------------|----|
| V_{PP} | Peak pulse voltage | ISO10605 (C = 330 pF, R = 330 Ω): | kV | |
| | | Contact discharge | | 30 |
| | | Air discharge | | 30 |
| | | ISO10605 / IEC 61000-4-2 (C = 150 pF, R = 330 Ω) | | |
| | Contact discharge | 30 | | |
| | Air discharge | 30 | | |
| P_{PP} | Peak pulse power dissipation | 10/1000 μs , T_j initial = T_{amb} | W | |
| T_{stg} | Storage temperature range | -65 to +150 | $^{\circ}\text{C}$ | |
| T_j | Operating junction temperature range | -55 to +150 | $^{\circ}\text{C}$ | |
| T_L | Maximum lead temperature for soldering during 10 s | 260 | $^{\circ}\text{C}$ | |

Figure 1. Electrical characteristics - parameter definitions

Figure 2. Pulse definition for electrical characteristics

Table 2. Electrical characteristics - parameter values ($T_{amb} = 25\text{ }^{\circ}\text{C}$, unless otherwise specified)

| Type | I_{RM} max at V_{RM} | | | V_{BR} at $I_{BR}^{(1)}$ | | | | 10 / 1000 μs | | | 8 / 20 μs | | | αT |
|----------------|--------------------------|-----------------------|------|----------------------------|------|------|----|-------------------------|----------------|----------|----------------------|----------------|----------|----------------------------|
| | | | | | | | | $V_{CL}^{(2)(3)}$ | $I_{PP}^{(4)}$ | R_D | $V_{CL}^{(2)(3)}$ | $I_{PP}^{(4)}$ | R_D | |
| | 25 $^{\circ}\text{C}$ | 85 $^{\circ}\text{C}$ | | Min. | Typ. | Max. | | Max. | | Max. | Max. | | Max. | |
| | μA | V | | V | | | mA | V | A | Ω | V | A | Ω | $10^{-4}/^{\circ}\text{C}$ |
| SM6T6V8AY/CAY | 20 | 50 | 5.80 | 6.45 | 6.8 | 7.14 | 10 | 10.5 | 57 | 0.059 | 14.4 | 275 | 0.027 | 5.7 |
| SM6T7V5AY/CAY | 20 | 50 | 6.40 | 7.13 | 7.5 | 7.88 | 10 | 11.3 | 53 | 0.065 | 15.2 | 266 | 0.027 | 6.1 |
| SM6T10AY/CAY | 20 | 50 | 8.55 | 9.5 | 10.0 | 10.5 | 1 | 14.5 | 41 | 0.098 | 18.6 | 215 | 0.038 | 7.3 |
| SM6T12AY/CAY | 0.2 | 1 | 10.2 | 11.4 | 12 | 12.6 | 1 | 16.7 | 36 | 0.114 | 21.7 | 184 | 0.049 | 7.8 |
| SM6T15AY/CAY | 0.2 | 1 | 12.8 | 14.3 | 15 | 15.8 | 1 | 21.2 | 28 | 0.193 | 27.2 | 147 | 0.078 | 8.4 |
| SM6T16V5AY/CAY | 0.2 | 1 | 14.1 | 15.7 | 16.5 | 17.3 | 1 | 23.1 | 26 | 0.254 | 29 | 136 | 0.092 | 8.6 |
| SM6T18AY/CAY | 0.2 | 1 | 15.3 | 17.1 | 18 | 18.9 | 1 | 25.2 | 24 | 0.263 | 32.5 | 123 | 0.111 | 8.8 |
| SM6T22AY/CAY | 0.2 | 1 | 18.8 | 20.9 | 22 | 23.1 | 1 | 30.6 | 20 | 0.375 | 39.3 | 102 | 0.159 | 9.2 |
| SM6T24AY/CAY | 0.2 | 1 | 20.5 | 22.8 | 24 | 25.2 | 1 | 33.2 | 18 | 0.444 | 42.8 | 93 | 0.189 | 9.4 |
| SM6T27AY/CAY | 0.2 | 1 | 23.1 | 25.7 | 27 | 28.4 | 1 | 37.5 | 16 | 0.569 | 48.3 | 83 | 0.240 | 9.6 |
| SM6T30AY/CAY | 0.2 | 1 | 25.6 | 28.5 | 30 | 31.5 | 1 | 41.5 | 14.5 | 0.690 | 53.5 | 75 | 0.293 | 9.7 |
| SM6T33AY/CAY | 0.2 | 1 | 28.2 | 31.4 | 33 | 34.7 | 1 | 45.7 | 13.1 | 0.840 | 59.0 | 68 | 0.357 | 9.8 |
| SM6T36AY/CAY | 0.2 | 1 | 30.8 | 34.2 | 36 | 37.8 | 1 | 49.9 | 12 | 1.01 | 64.3 | 62 | 0.427 | 9.9 |
| SM6T39AY/CAY | 0.2 | 1 | 33.3 | 37.1 | 39 | 41.0 | 1 | 53.9 | 11.1 | 1.16 | 69.7 | 57 | 0.504 | 10.0 |
| SM6T42AY/CAY | 0.2 | 1 | 36 | 40 | 42.1 | 44.2 | 1 | 58.1 | 10.3 | 1.35 | 76 | 52 | 0.611 | 10.0 |
| SM6T47AY/CAY | 0.2 | 1 | 40 | 44 | 46.7 | 49.0 | 1 | 64.5 | 9.7 | 1.59 | 84.0 | 48.0 | 0.728 | 10.1 |
| SM6T56AY/CAY | 0.2 | 1 | 47.6 | 53.2 | 56 | 58.8 | 1 | 76.6 | 7.8 | 2.28 | 100 | 40 | 1.030 | 10.0 |
| SM6T68AY/CAY | 0.2 | 1 | 58.1 | 64.6 | 68 | 71.4 | 1 | 92 | 6.5 | 3.17 | 121 | 33 | 1.503 | 10.4 |
| SM6T75AY/CAY | 0.2 | 1 | 64.1 | 71.3 | 75 | 78.8 | 1 | 103 | 5.8 | 4.17 | 134 | 30 | 1.84 | 10.5 |
| SM6T82AY/CAY | 0.2 | 1 | 70.0 | 77.8 | 81.9 | 86.0 | 1 | 113 | 5.5 | 4.91 | 146 | 27.0 | 2.22 | 10.5 |

1. To calculate V_{BR} versus T_j : V_{BR} at $T_j = V_{BR}$ at $25\text{ }^{\circ}\text{C} \times (1 + \alpha T \times (T_j - 25))$
2. To calculate V_{CL} versus T_j : V_{CL} at $T_j = V_{CL}$ at $25\text{ }^{\circ}\text{C} \times (1 + \alpha T \times (T_j - 25))$
3. To calculate V_{CL} max versus $I_{PPappli}$: $V_{CLmax} = V_{BR}$ max + $RD \times I_{PPappli}$
4. Surge capability given for both directions for unidirectional and bidirectional devices

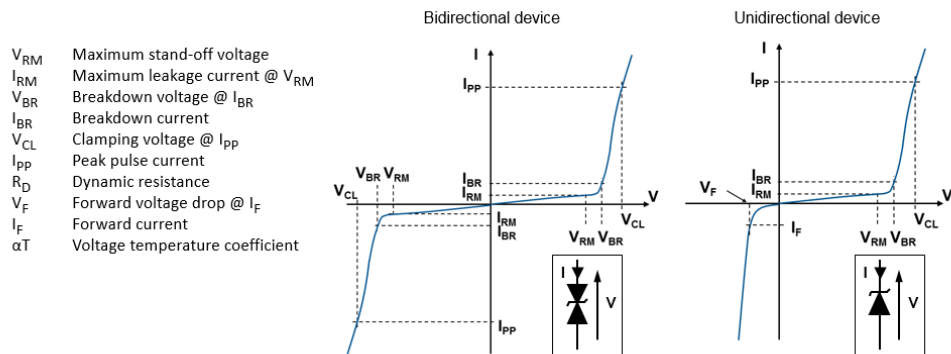
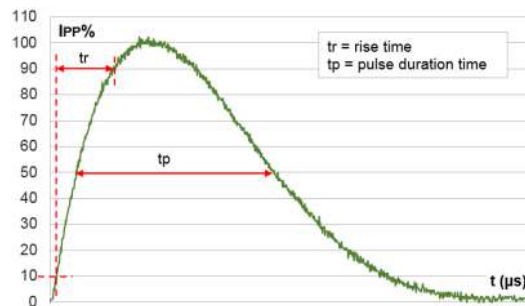
1.1 Characteristics (curves)

Figure 3. Maximum peak power dissipation versus initial junction temperature

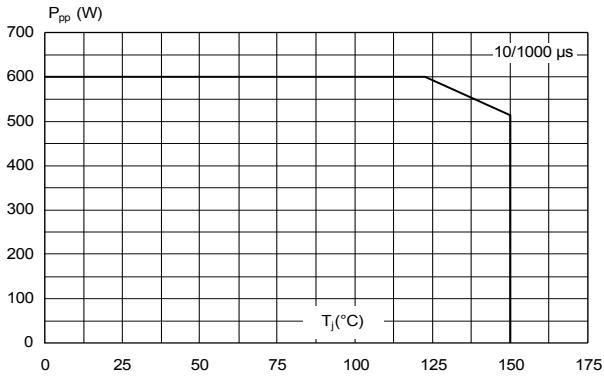

Figure 4. Maximum peak pulse power versus exponential pulse duration

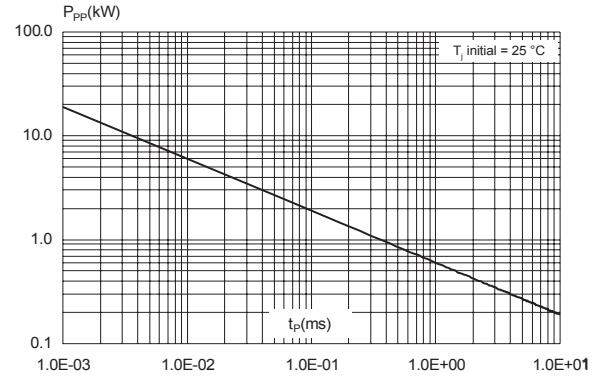

Figure 5. Maximum peak pulse current versus clamping voltage

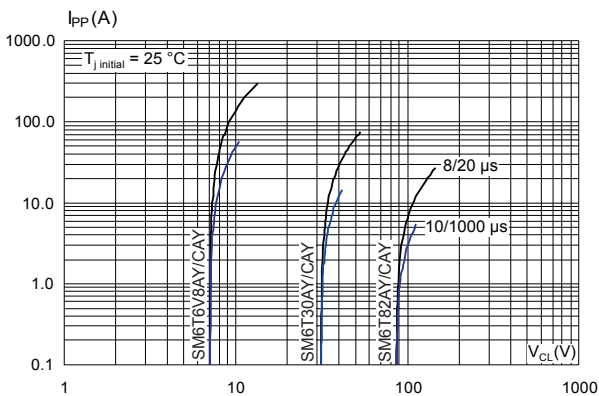

Figure 6. Dynamic resistance versus pulse duration

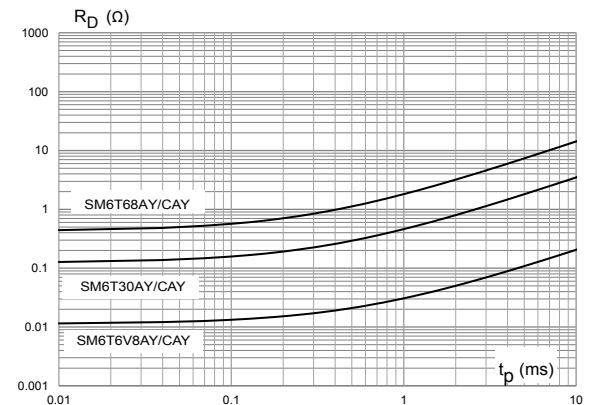

Figure 7. Junction capacitance versus reverse applied voltage (unidirectional types)

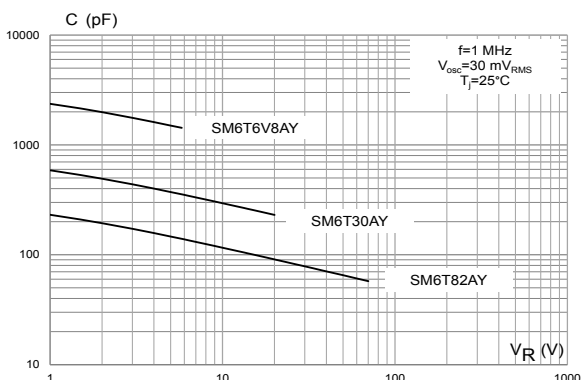

Figure 8. Junction capacitance versus applied voltage (bidirectional type)

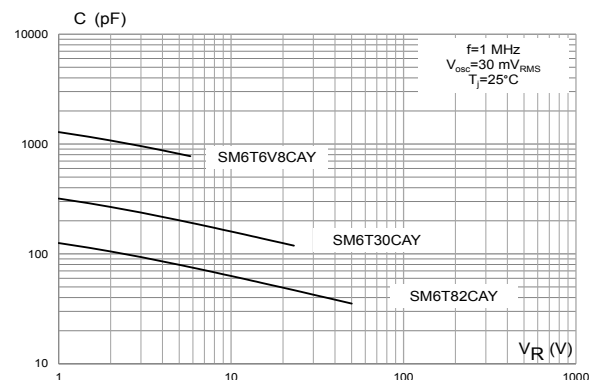

Figure 9. Leakage current versus junction temperature

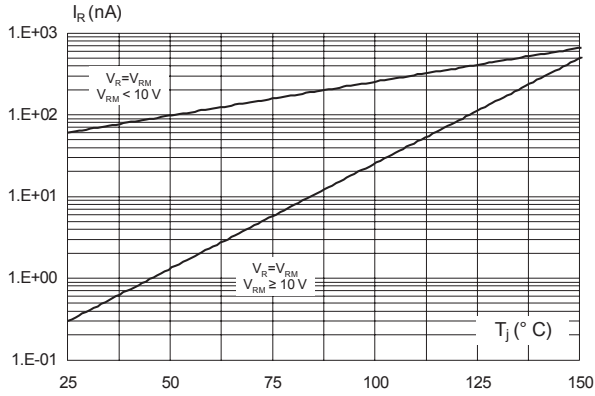

Figure 10. Peak forward voltage drop versus peak forward current

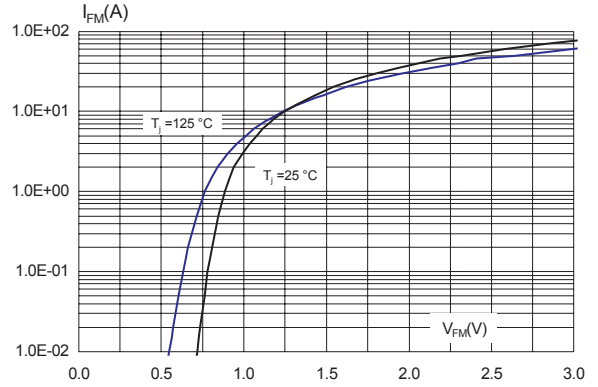

Figure 11. Thermal impedance junction to ambient versus pulse duration

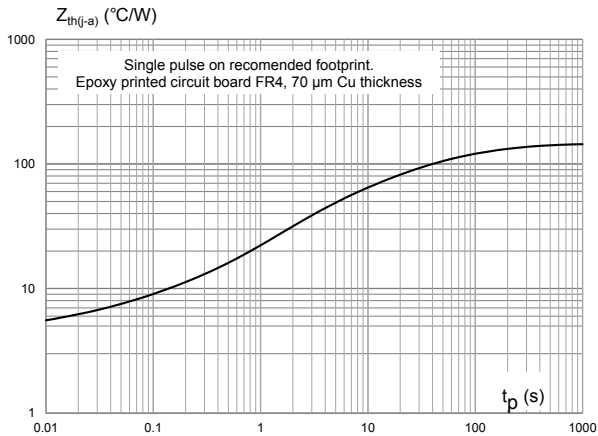

Figure 12. Thermal resistance junction to ambient versus copper area under each lead

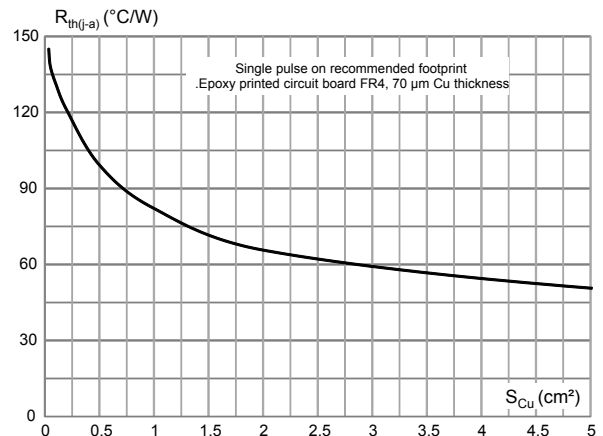

Figure 13. ISO7637-2 pulse 1: Vs = -150 V with 12 V battery

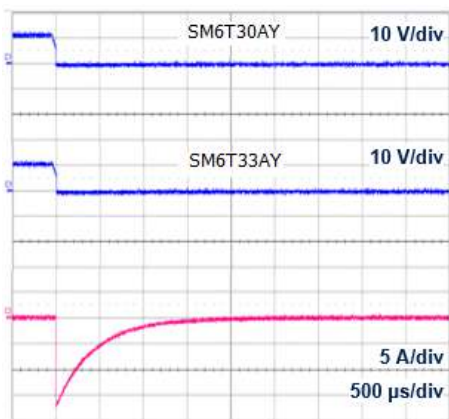

Figure 14. ISO7637-2 pulse 2a: Vs = +112 V with 12 V battery

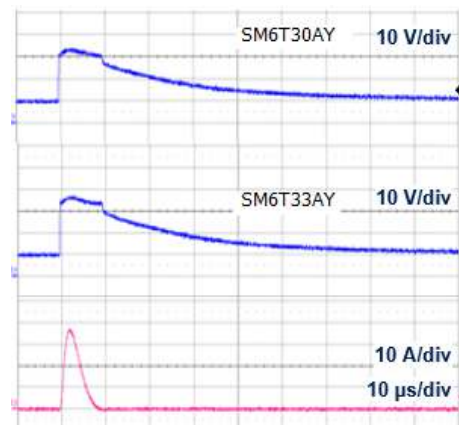

Figure 15. ISO7637-2 pulse 3a: $V_s = -220\text{ V}$ with 12 V battery

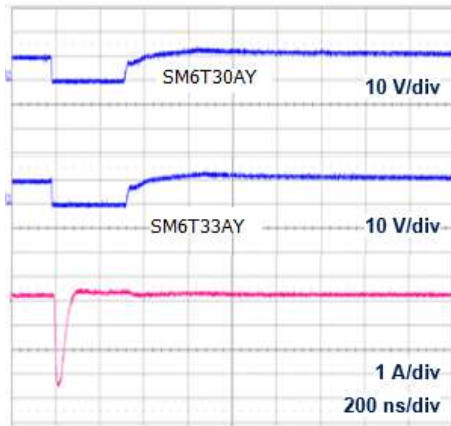
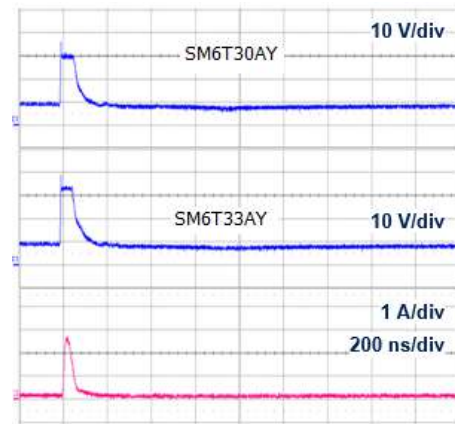

Figure 16. ISO7637-2 pulse 3b: $V_s = +150\text{ V}$ with 12 V battery



2 Package information

In order to meet environmental requirements, ST offers these devices in different grades of **ECOPACK** packages, depending on their level of environmental compliance. ECOPACK specifications, grade definitions and product status are available at: www.st.com. ECOPACK is an ST trademark.

2.1 SMB package information

Figure 17. SMB package outline

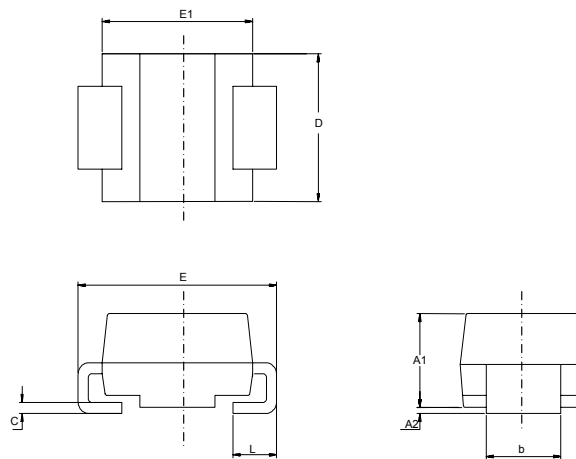

Table 3. SMB package mechanical data

| Ref. | Dimensions | | | |
|------|-------------|------|-----------------------|--------|
| | Millimeters | | Inches ⁽¹⁾ | |
| | Min. | Max. | Min. | Max. |
| A1 | 1.90 | 2.45 | 0.0748 | 0.0965 |
| A2 | 0.05 | 0.20 | 0.0020 | 0.0079 |
| b | 1.95 | 2.20 | 0.0768 | 0.0867 |
| c | 0.15 | 0.40 | 0.0059 | 0.0157 |
| D | 3.30 | 3.95 | 0.1299 | 0.1556 |
| E | 5.10 | 5.60 | 0.2008 | 0.2205 |
| E1 | 4.05 | 4.60 | 0.1594 | 0.1811 |
| L | 0.75 | 1.50 | 0.0295 | 0.0591 |

1. Values in inches are converted from mm

Figure 18. SMB recommended footprint

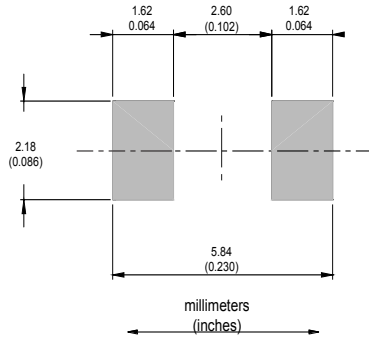

Figure 19. Marking layout

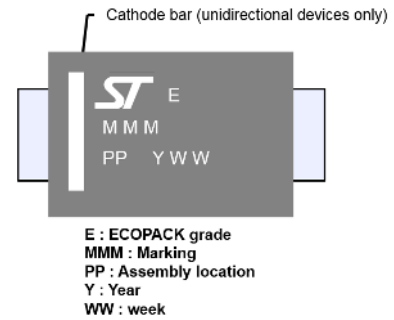
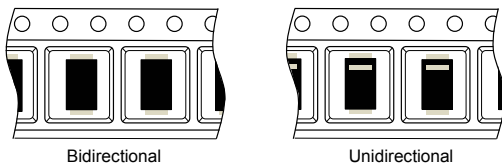

Figure 20. Package orientation in reel



Taped according to EIA-481
Pocket dimensions are not on scale.
Pocket shape may vary depending on package
On bidirectional devices, marking and logo may not be always in the same direction.

Figure 21. Tape and reel orientation

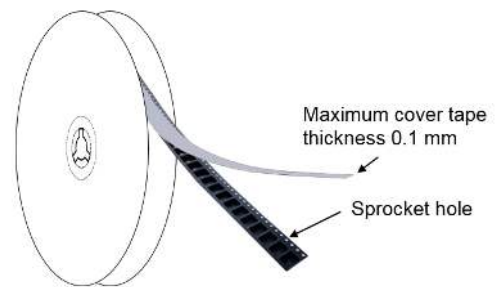

Figure 22. Reel dimensions (mm)

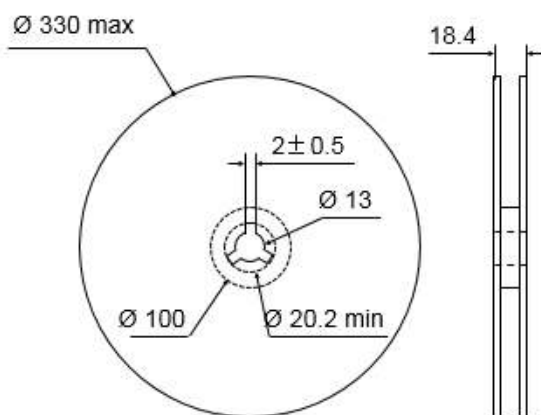

Figure 23. Inner box dimensions (mm)

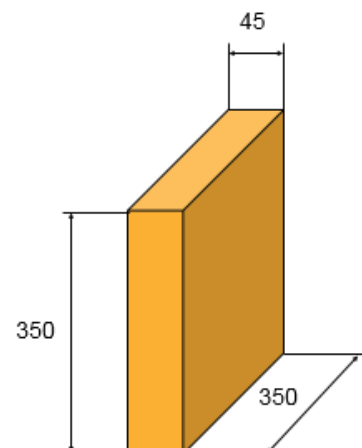
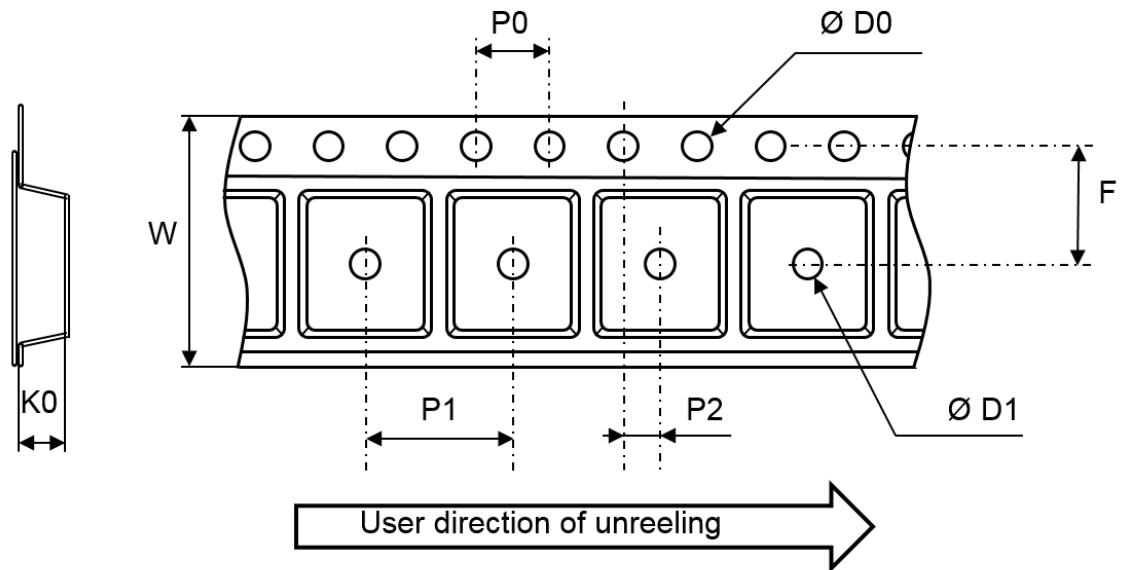

Figure 24. Tape and reel outline



Note: Pocket dimensions are not on scale
Pocket shape may vary depending on package

Table 4. Tape and reel mechanical data

| Ref. | Dimensions | | |
|------|-------------|------|------|
| | Millimeters | | |
| | Min. | Typ. | Max. |
| ØD0 | 1.5 | 1.55 | 1.6 |
| ØD1 | 1.5 | | |
| F | 5.4 | 5.5 | 5.6 |
| K0 | 2.64 | 2.74 | 2.84 |
| P0 | 3.9 | 4.0 | 4.1 |
| P1 | 7.9 | 8.0 | 8.1 |
| P2 | 1.9 | 2.0 | 2.1 |
| W | 11.7 | 12.0 | 12.3 |

2.2 Reflow profile

Figure 25. ST ECOPACK recommended soldering reflow profile for PCB mounting

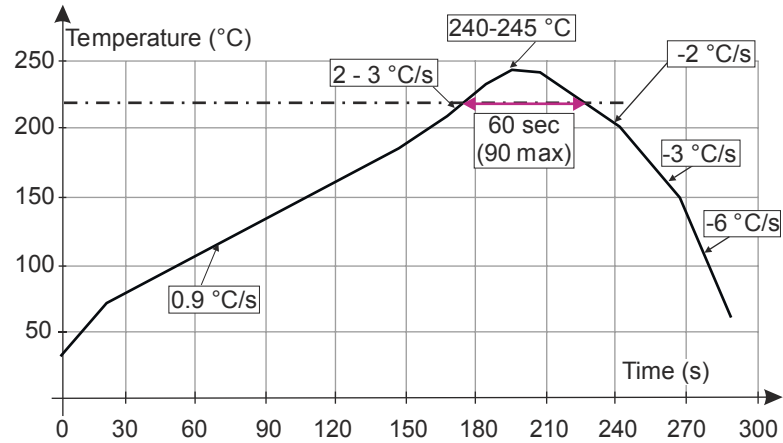

Note: Minimize air convection currents in the reflow oven to avoid component movement. Maximum soldering profile corresponds to the latest IPC/JEDEC J-STD-020.

3 Application and design guidelines

More information is available in the application note AN2689 “Protection of automotive electronics from electrical hazards, guidelines for design and component selection”.

4 Ordering information

Figure 26. Ordering information scheme

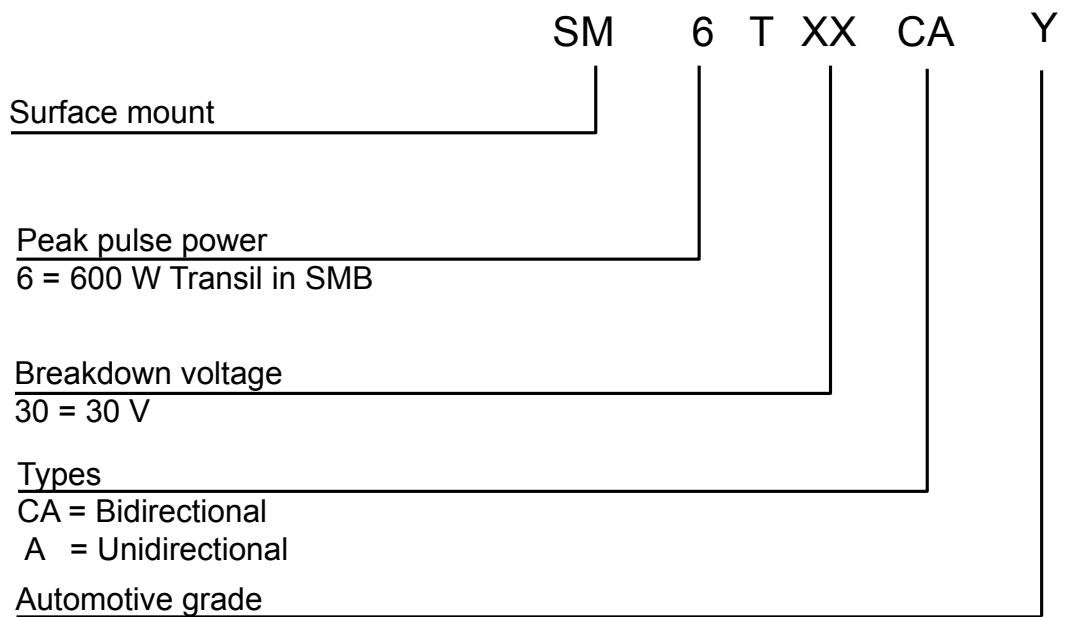

Table 5. Ordering information

| Order code | Marking | Package | Weight | Base qty. | Delivery mode |
|-----------------|----------------------|---------|--------|-----------|---------------|
| SM6TxxxAY / CAY | See Table 6. Marking | SMB | 0.11 g | 2500 | Tape and reel |

Table 6. Marking

| Order code | Marking | Order code | Marking |
|------------|---------|-------------|---------|
| SM6T6V8AY | DEY | SM6T6V8CAY | LEY |
| SM6T7V5AY | DGY | SM6T7V5CAY | LGY |
| SM6T10AY | DPY | SM6T10CAY | LPY |
| SM6T12AY | DTY | SM6T12CAY | LTY |
| SM6T15AY | DXY | SM6T15CAY | LXY |
| SM6T16V5AY | DZY | SM6T16V5CAY | LZY |
| SM6T18AY | EEY | SM6T18CAY | MEY |
| SM6T22AY | EKY | SM6T22CAY | MKY |
| SM6T24AY | EMY | SM6T24CAY | MMY |
| SM6T27AY | EPY | SM6T27CAY | MPY |
| SM6T30AY | ERY | SM6T30CAY | MRY |
| SM6T33AY | ETY | SM6T33CAY | MTY |
| SM6T36AY | EYV | SM6T36CAY | MVY |
| SM6T39AY | EXY | SM6T39CAY | MXY |
| SM6T42AY | FBY | SM6T42CAY | NAY |
| SM6T47AY | FAY | SM6T47CAY | NBY |
| SM6T56AY | FLY | SM6T56CAY | NLY |
| SM6T68AY | FQY | SM6T68CAY | NQY |
| SM6T75AY | FSY | SM6T75CAY | NSY |
| SM6T82AY | FWY | SM6T82CAY | NWY |

Revision history

Table 7. Document revision history

| Date | Version | Changes |
|-------------|---------|---|
| 15-Sep-2010 | 1 | Initial release. |
| 18-Oct-2011 | 2 | Deleted old Table 2. Thermal parameter. Updated Table 2 and added order codes in Table 4. Updated Figure 5, Figure 10 and Figure 11. Updated Complies with the following standards on page 1. |
| 27-Mar-2012 | 3 | Added footnote on page 1. |
| 26-Sep-2014 | 4 | Updated Table 2 and Table 4. Reformatted to current standard. |
| 19-Nov-2014 | 5 | Updated Figure 7 and Figure 8. |
| 05-Oct-2015 | 6 | Updated Figure 17. |
| 09-Jan-2018 | 7 | Updated Table 2: "Electrical characteristics parameter values ($T_{amb} = 25\text{ }^{\circ}\text{C}$, unless otherwise specified)". |
| 16-Mar-2018 | 8 | Updated revision numbering. |
| 20-Mar-2018 | 9 | Updated order code SM6T16V5AY/SM6T16V5CAY. |
| 02-May-2019 | 10 | Updated Section 1.1 Characteristics (curves) and Table 6. Marking . Added Section 2.2 Reflow profile and Section 3 Application and design guidelines . |
| 07-Jul-2021 | 11 | Updated Figure 12 , Figure 14 , Figure 15 , Figure 16 and Figure 17 . Inserted Figure 7 . |

IMPORTANT NOTICE – PLEASE READ CAREFULLY

STMicroelectronics NV and its subsidiaries (“ST”) reserve the right to make changes, corrections, enhancements, modifications, and improvements to ST products and/or to this document at any time without notice. Purchasers should obtain the latest relevant information on ST products before placing orders. ST products are sold pursuant to ST’s terms and conditions of sale in place at the time of order acknowledgement.

Purchasers are solely responsible for the choice, selection, and use of ST products and ST assumes no liability for application assistance or the design of Purchasers’ products.

No license, express or implied, to any intellectual property right is granted by ST herein.

Resale of ST products with provisions different from the information set forth herein shall void any warranty granted by ST for such product.

ST and the ST logo are trademarks of ST. For additional information about ST trademarks, please refer to www.st.com/trademarks. All other product or service names are the property of their respective owners.

Information in this document supersedes and replaces information previously supplied in any prior versions of this document.

© 2021 STMicroelectronics – All rights reserved