

USER GUIDE

Aranet PRO/Aranet PRO Plus/ Aronet PRO Plus LTE

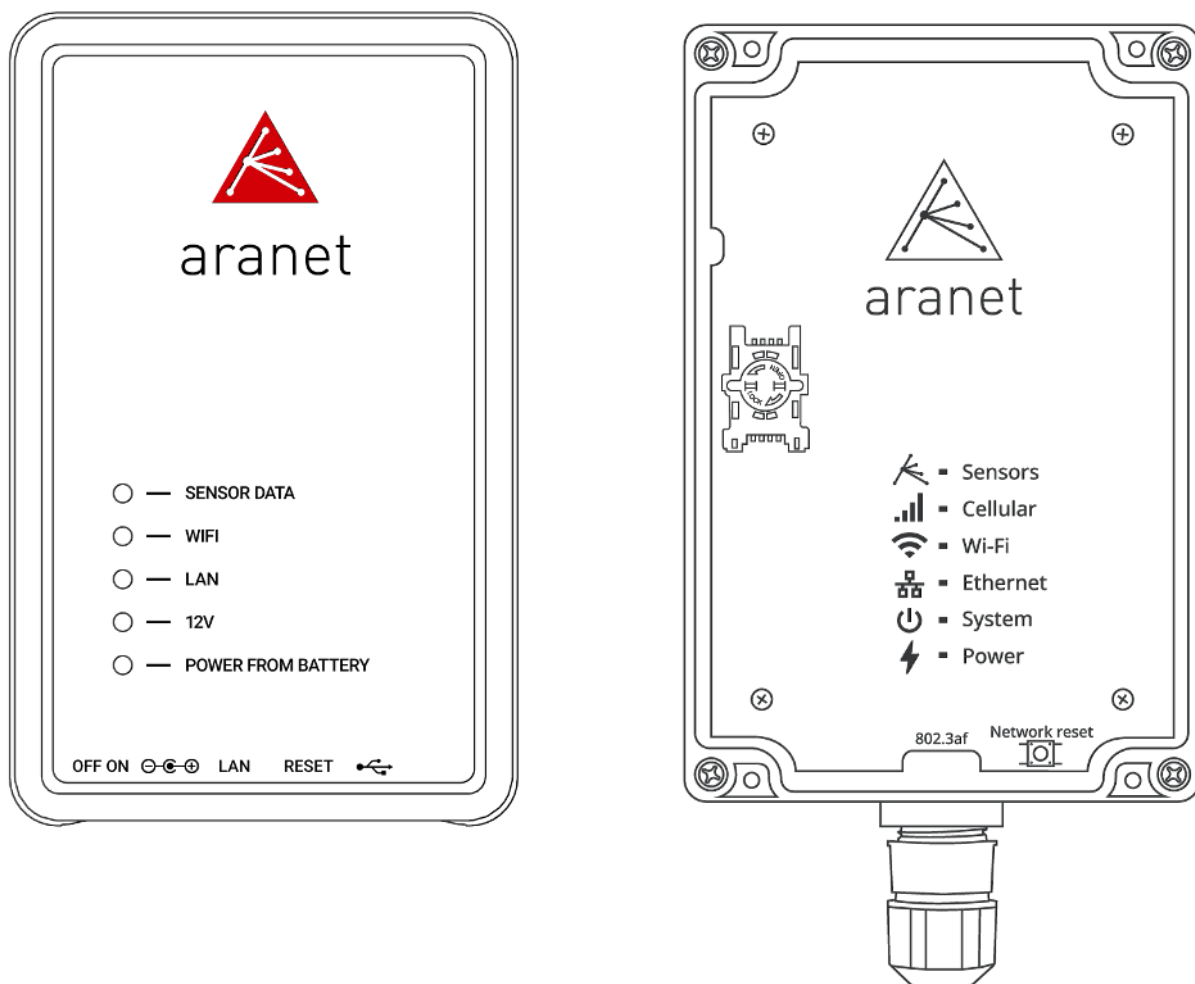

Applicable for **Aranet PRO/Aranet PRO Plus** with firmware starting from v.3.2.4

Document revision v.9.5

March 2023

FCC Compliance statement

This equipment has been tested and found to comply with the limits for a Class B digital device, pursuant to part 15 of the FCC Rules. These limits are designed to provide reasonable protection against harmful interference in a residential installation. This equipment generates, uses and can radiate radio frequency energy and, if not installed and used in accordance with the instructions, may cause harmful interference to radio communications. However, there is no guarantee that interference will not occur in a particular installation. If this equipment does cause harmful interference to radio or television reception, which can be determined by turning the equipment off and on, the user is encouraged to try to correct the interference by one or more of the following measures:

- Reorient or relocate the device.
- Increase the separation between the equipment and receiver.
- Connect the equipment into an outlet on a circuit different from the one the receiver is connected to.
- Consult the dealer or an experienced radio/TV technician for help.

FCC Radiation Exposure Statement

This equipment complies with FCC radiation exposure limits set forth for an uncontrolled environment. This equipment should be installed and operated with a minimum distance of 20 cm between the radiator and your body.



Changes or modifications not expressly approved by the party responsible for compliance could void the user's authority to operate the equipment.

Aranet PRO/PRO Plus does not contain serviceable parts. Warranty will not be applicable in the event of Aranet PRO has been opened or Aranet PRO Plus warranty seals are damaged.

The information presented in this guide is the property of SAF Tehnika, JSC. No part of this document may be reproduced or transmitted without proper permission from SAF Tehnika, JSC.

The specifications or information contained in this document are subject to change without notice due to continuing introduction of design improvements. If there is any conflict between this document and compliance statements, the latter will supersede this document.

SAF Tehnika, JSC has no liability for typing errors in this document or damages of any kind that result from the use of this document.

To get up to date information about accessories and their availability, please contact sales representative.

Industry Canada Regulatory Statement

This device complies with Industry Canada's license-exempt RSSs. Operation is subject to the following two conditions:

1. This device may not cause interference; and
2. This device must accept any interference, including interference that may cause undesired operation of the device.

Le présent appareil est conforme aux CNR d'Industrie Canada applicables aux appareils radio exempts de licence. L'exploitation est autorisée aux deux conditions suivantes: (1) l'appareil ne doit pas produire de brouillage, et (2) l'utilisateur de l'appareil doit accepter tout brouillage radioélectrique subi, même si le brouillage est susceptible d'en compromettre le fonctionnement.

TABLE OF CONTENTS

1	INTRODUCTION	6
1.1	<i>ARANET PRO BASE OVERVIEW</i>	7
1.1.1	What's in the box	7
1.1.2	Aranet PRO indicators	8
1.1.3	Aranet PRO mounting	9
1.1.4	Aranet PRO ports	9
1.1.5	Aranet PRO power options	10
1.1.6	Internal battery backup	10
1.2	<i>ARANET PRO Plus BASE OVERVIEW</i>	11
1.2.1	What's in the box	11
1.2.2	Aranet PRO Plus front view	12
1.2.3	Aranet PRO Plus indicators	13
1.2.4	Aranet PRO Plus mounting	13
1.2.5	SIM-card installation	14
1.2.6	Aranet PRO Plus power options	15
1.2.7	Emergency switching off	15
1.3	<i>ARANET PRO/PRO Plus SPECIFICATIONS</i>	16
2	INITIAL SETUP	18
2.1	<i>Initial setup of Aranet PRO/PRO Plus</i>	18
2.1.1	Initial setup of Aranet PRO/PRO Plus using built-in Wi-Fi Access Point	18
2.1.2	Initial setup of Aranet PRO/PRO Plus using Ethernet cable	19
2.1.3	Initial Login and Fast Settings	20
2.2	<i>Pair sensors to Aranet PRO /PRO Plus</i>	24
2.3	<i>Connecting Aranet PRO/PRO Plus to internet network</i>	26
2.3.1	Connecting Aranet PRO/PRO Plus to internet network using Ethernet cable	27
2.3.2	Connecting Aranet PRO/PRO Plus to internet network using local Wi-Fi network	29
2.3.3	Connecting Aranet PRO Plus LTE to internet network using LTE Modem	32
2.4	<i>Accessing the Aranet PRO/PRO Plus from Internet</i>	33
3	ARANET SENSORHUB OVERVIEW	34
3.1	<i>Main navigation bar</i>	34
3.2	<i>Main menu</i>	34
3.3	<i>Graphs</i>	36
3.4	<i>Sensors</i>	39
3.5	<i>Groups</i>	39
3.5.1	Using groups	39
3.6	<i>System</i>	41
3.6.1	Status menu	41
3.6.2	Region menu	42
3.6.3	Time menu	43
3.6.4	Network menu	44
3.6.5	Firmware menu	48
3.6.6	Backup menu	50
3.6.7	Tools menu	51
3.6.8	Licenses menu	51
3.6.9	Notifications	52
3.6.10	Radio menu	59
3.6.11	Aranet MINI monitor mode	60
3.6.12	Users menu	62

3.6.13	SNMP menu	63
3.7	<i>Integrations</i>	64
3.7.1	MQTT	64
3.7.2	Aranet Cloud	67
3.7.3	Modbus	70
4	SENSORS' SPECIFIC NOTES	73
4.1.1	Weight Sensor	73
4.1.2	Soil (Substrate) VWC, EC and T Sensor	74
4.1.3	4-20 mA and Voltage Sensors	78
4.1.4	Stem Micro-Variation sensor	79
4.1.5	Ultrasonic Distance sensor	82
4.1.6	CO2 and Temperature sensor	83
4.1.7	Pulse Counter sensor	83
4.1.8	NH3 Sensor kit	84
5	LEGAL INFORMATION	85
5.1	<i>TERMS OF USE</i>	85
5.2	<i>WARRANTY</i>	85
5.3	<i>RMA (RETURN MERCHANDISE AUTHORIZATION) FORM</i>	87
5.4	<i>INTELLECTUAL PROPERTY RIGHTS</i>	88
5.5	<i>DATA SECURITY</i>	88
5.6	<i>CLEANING AND MAINTENANCE</i>	88
5.7	<i>ACCESSORIES</i>	89
5.8	<i>DISCLAIMER</i>	89
5.9	<i>ADDITIONAL INFORMATION</i>	89

1 INTRODUCTION

Aranet offers environmental monitoring solutions for a variety of businesses. Aranet PRO and Aranet PRO Plus are industrial grade environment monitoring solutions.

Aranet PRO/PRO Plus can support 12, 50 or 100 sensors depending on license purchased.

The base station has exceptional sensitivity and allows placing the sensors within line-of-sight range of at least 3km/1.9mi.

All Aranet PRO/Aranet PRO Plus base stations include embedded local webserver Aranet SensorHUB. Easy to use interface allows viewing, analyzing, and comparing data in real time, setting thresholds for alarms as well as exporting reports. Responsive design of the software adapts to smartphone, tablet, or laptop.

Document describes the functionality of Aranet PRO/Aranet PRO Plus with firmware version starting v3.0.1.



Aranet PRO and Aranet PRO Plus /PRO Plus LTE differences in hardware and software are highlighted in corresponding chapters using the icon.

Aranet PRO Plus and Aranet PRO Plus LTE differ by 4G LTE modem incorporated in PRO Plus LTE only. The common title "Aranet PRO Plus" is used in this document except the chapters concerning the modem presence.



Aranet PRO having part numbers TDSBWPA1.xxx, TDSBWPA2.xxx, TDSBWPC2.xxx are referred in this document as **Aranet PRO Mk2** and their specific differences in software are highlighted in corresponding chapters using the icon.

Visit www.aranet.com for more information.

1.1 ARANET PRO BASE OVERVIEW

1.1.1 What's in the box

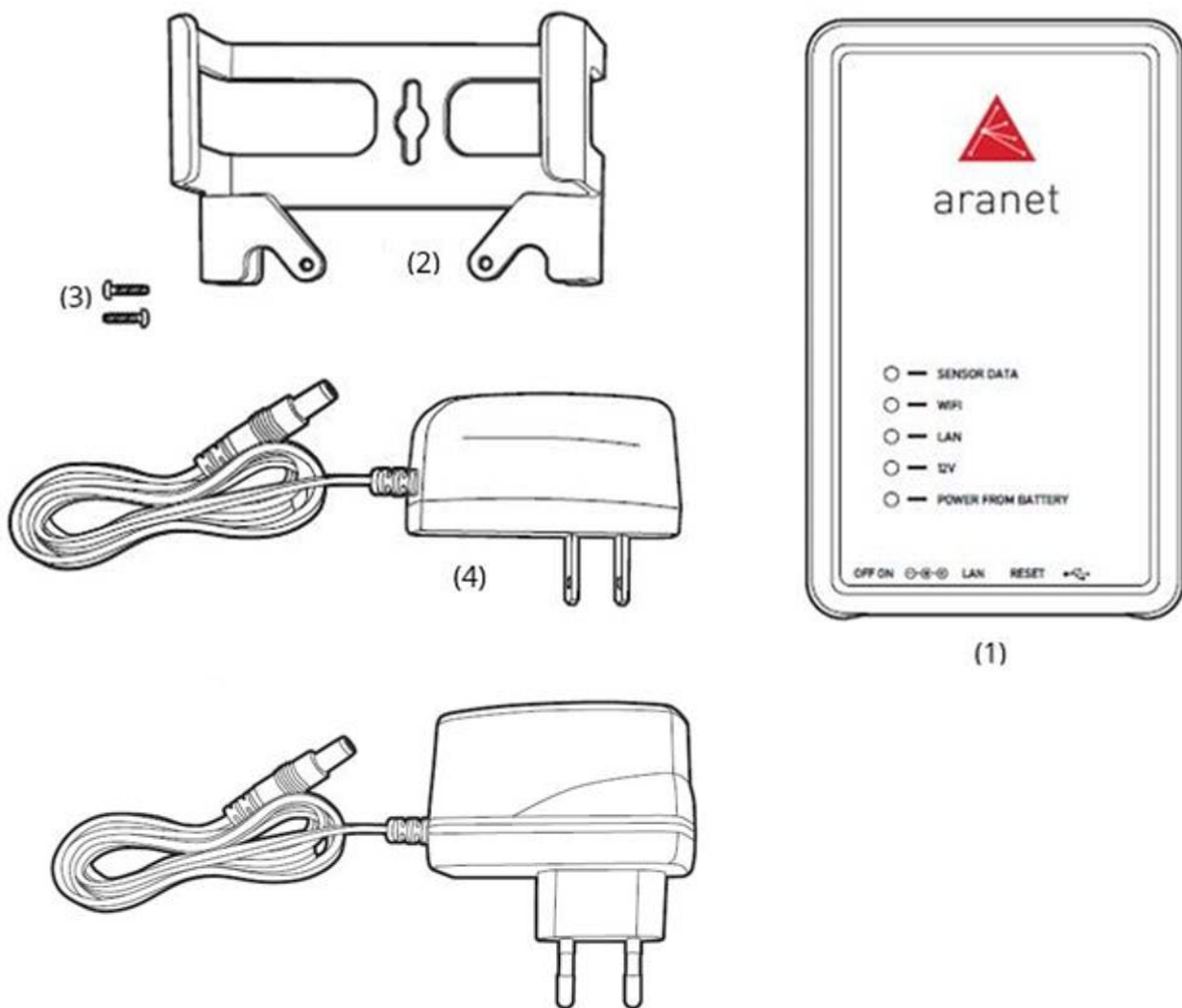

- (1) 1 pc of Aranet PRO base station with installed Aranet SensorHUB software and License
- (2) 1 pc of Aranet PRO base station mount
- (3) 2 pcs of W1412 screws
- (4) 1 pc of AC power adapter (EU or US version depending on product version)

1.1.2 Aranet PRO indicators

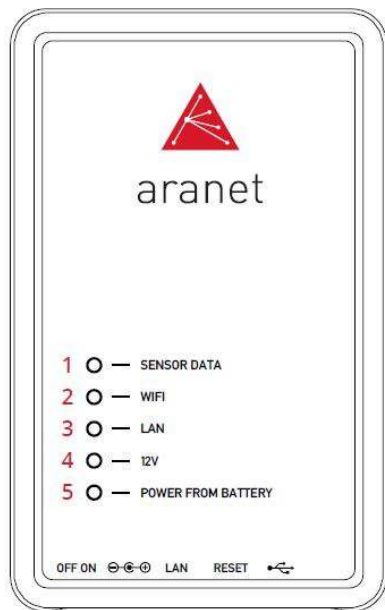

- (1) Sensor data indicator LED – flashes amber every time a data packet is received from a sensor.
- (2) Wi-Fi connection indicator LED – amber light when Aranet PRO is connected to Wi-Fi or works in Access Point mode
- (3) LAN connection indicator LED – amber light when Aranet PRO is connected to LAN connection through an Ethernet cable
- (4) 12V power indicator LED – green light when Aranet PRO is connected to 12V power either through a PoE connection or with the included AC power adapter
- (5) Battery power indicator LED – red light when Aranet PRO is using built in backup battery power

1.1.3 Aranet PRO mounting

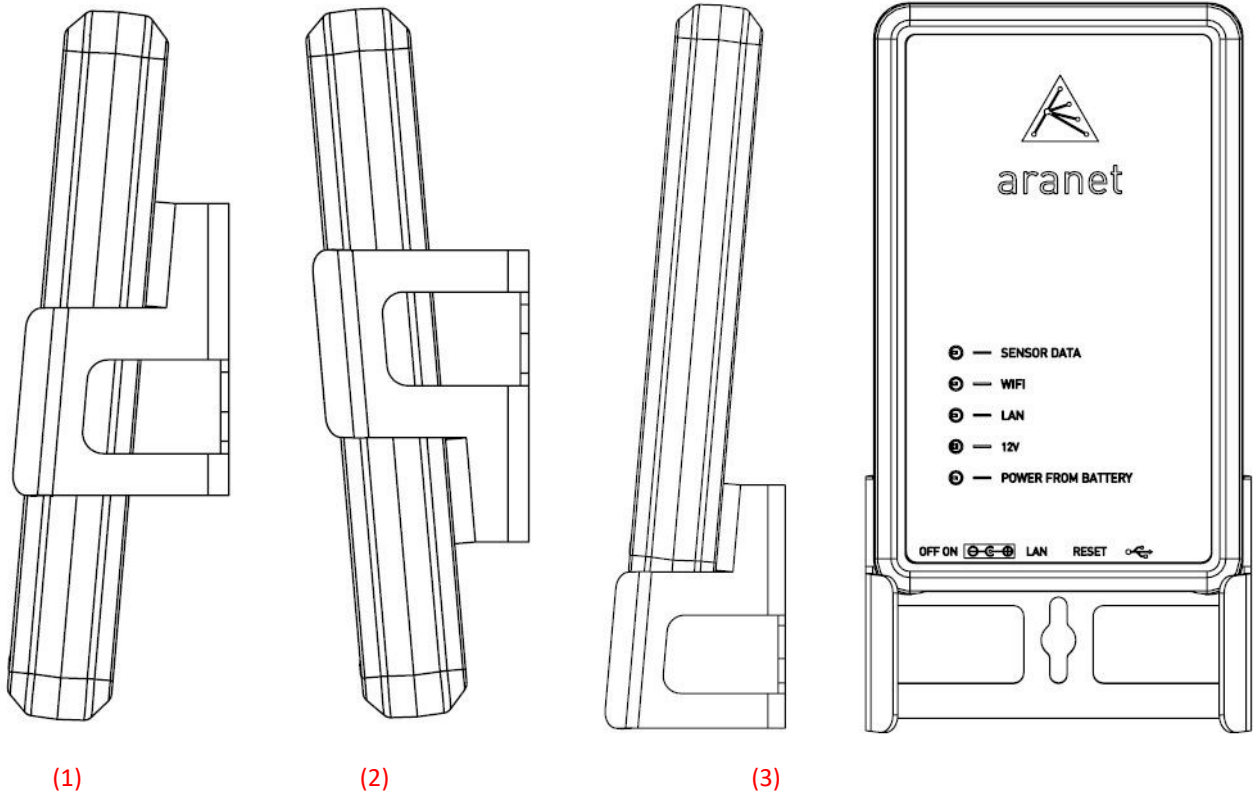

- (1) Base station mount configuration for positioning on vertical surface (e.g., wall).
- (2) Base station mount configuration for positioning on vertical surface (e.g., wall).
- (3) Base station mount configuration for placement on horizontal surface (e.g., table).

1.1.4 Aranet PRO ports

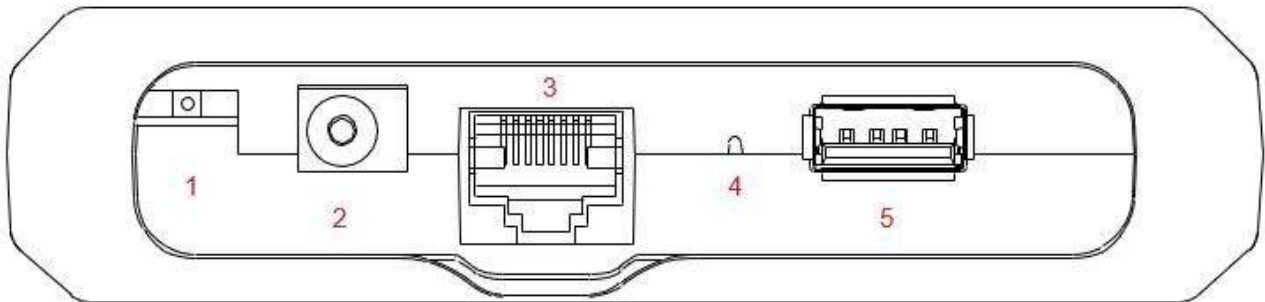

- (1) On-Off switch – switch in the left position means Aranet PRO is turned off, switch in the right position means Aranet PRO is turned *ON*
- (2) AC Power port - for using the included AC power adapter to power Aranet PRO
- (3) Ethernet port – for LAN connectivity as well as PoE connectivity
- (4) Reset button, press, and hold for 5 seconds or more and then release the button to reset network settings and password of “root” user account. The reset button is accessed through hole with some thin object like pencil.
- (5) USB port – for connecting USB modem to enable SMS notification functionality, and for connecting and configuring Aranet MINI.

1.1.5 Aranet PRO power options

Aranet PRO can be powered with the included power adapter either directly or via the optional passive Ethernet injector PN TDAPOE01.

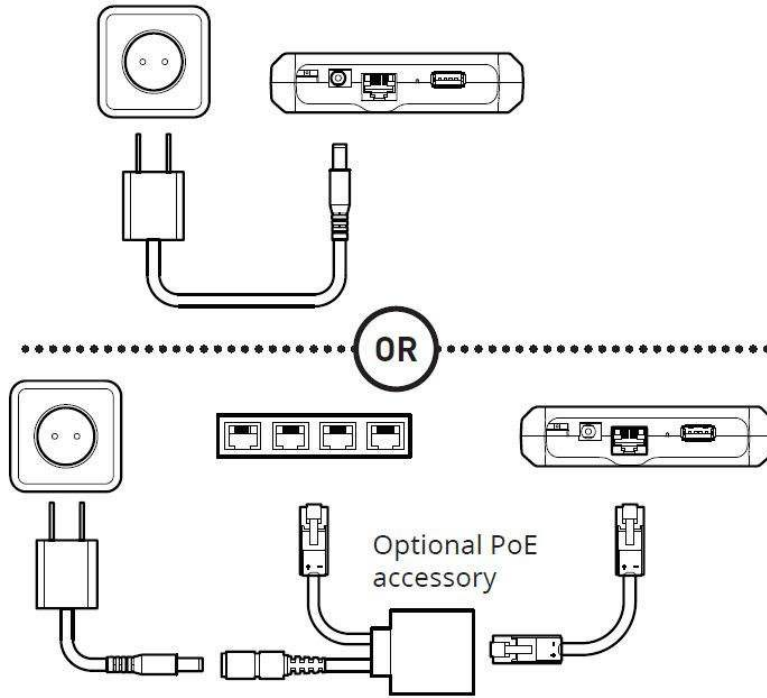

1.1.6 Internal battery backup

Aranet PRO is supplied with built in battery backup providing up to 30 minutes of power supply in case of main power failure. It is meant only as a backup and allows Aranet PRO to shut down safely. System warning (if enabled) will be issued in case of main power failure and before Aranet PRO switches off completely. Warning will be sent as email and/or SMS to the destination configured by users belonging to the Administrator group.



!WARNING! ARANET PRO BASE STATIONS CONTAIN A LI-ION 14500 PROTECTED TYPE RECHARGEABLE BATTERY AND A CR2032 TYPE BATTERY. RISK OF DAMAGE IF BATTERY IS REPLACED BY AN INCORRECT TYPE. THE USER IS RESPONSIBLE FOR DISPOSAL OF BATTERIES ACCORDING TO THE STATE LEGISLATION.

1.2 ARANET PRO Plus BASE OVERVIEW

1.2.1 What's in the box

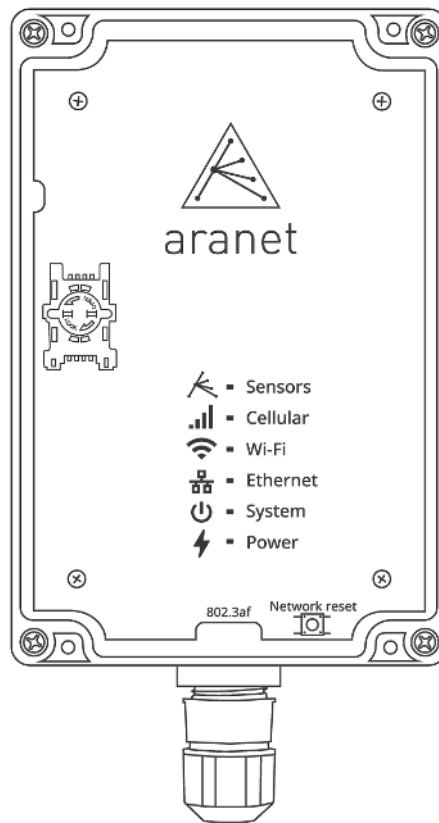

(1)

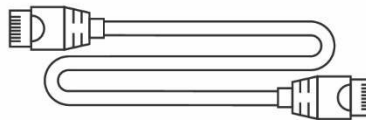

(2)

- (1) 1 pc of Aranet PRO Plus base station with installed Aranet SensorHUB software and License
- (2) 1 pc of Cat.5 Ethernet cable 1m

1.2.2 Aranet PRO Plus front view

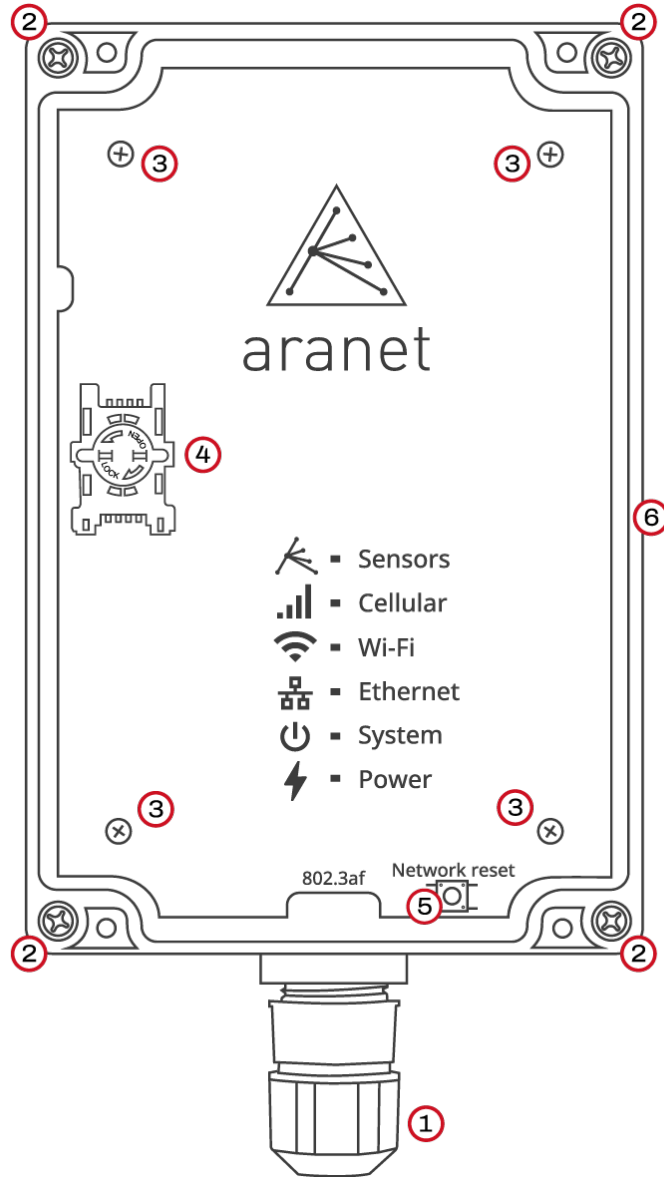

- (1) IP68 protected RJ-45 Ethernet port for Network and Power connection.
- (2) Screws for detaching/securing Aranet PRO Plus case lid – 4 pcs.
- (3) Warranty seals - Nylon screws – 4 pcs. Warranty is lost if damaged.
- (4) SIM-card holder (Aranet PRO Plus LTE P/N TDSBOB03, TDSBOBU3, TDSBOBC3 only).
- (5) Network Reset button; press and hold for 5 seconds or more and then release the button to reset network settings and password of “root” user account.
- (6) Humidity membrane.

1.2.3 Aranet PRO Plus indicators

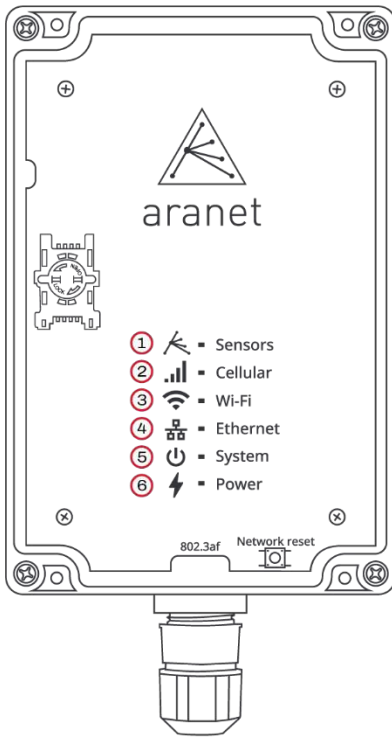

- (1) **Sensors** data indicator LED – flashes amber every time a data packet is received from a sensor.
- (2) **Cellular** connection indicator – slow flashes red when no SIM-card is installed, or no connection is established; fast flashes with steady pauses when connected to GSM LTE network.
- (3) **Wi-Fi** connection indicator LED – yellow light when Aranet PRO Plus Wi-Fi network interface is enabled, and base is connected to Wi-Fi or works in Access Point mode.
- (4) **Ethernet** connection indicator LED – yellow light when Aranet PRO Plus is connected to LAN using cable
- (5) **System** indicator – green light when Aranet PRO Plus system is started.
- (6) **Power** indicator LED – green light when Aranet PRO Plus is powered.

1.2.4 Aranet PRO Plus mounting

Aranet PRO Plus case has four dedicated holes for 4...4.5 mm screws by which base can be mounted to smooth surface:

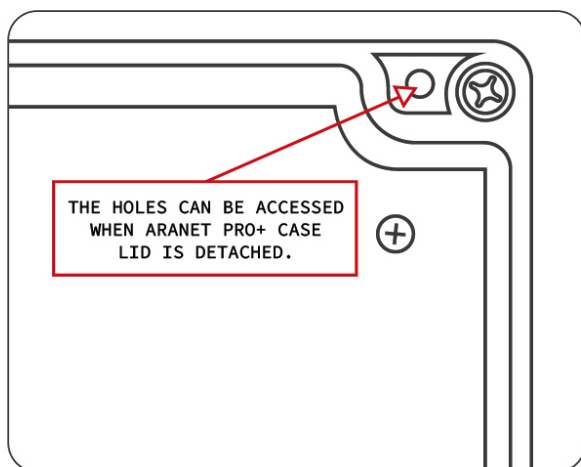

1.2.5 SIM-card installation

Aranet PRO Plus LTE P/N TDSBOB03, TDSBOBU3, TDSBOBC3 is equipped with GSM LTE 4G modem accepting Mini size SIM-card.

To install SIM-card into modem:

- (1) Disconnect Aranet PRO Plus LTE from power source and wait for system to shutdown (all LEDs go Off).
- (2) Detach Aranet PRO Plus LTE transparent lid by loosening 4 screws at the base's case corners.
- (3) Locate SIM-card holder.
- (4) Loosen the holder cover by rotating metal locking plate counterclockwise.
- (5) Flip the cover off.
- (6) Insert SIM-card into the cover observing correct orientation.
- (7) Flip cover back and fasten it by rotating metal locking plate clockwise.
- (8) Put back Aranet PRO Plus LTE lid and fasten 4 screws.

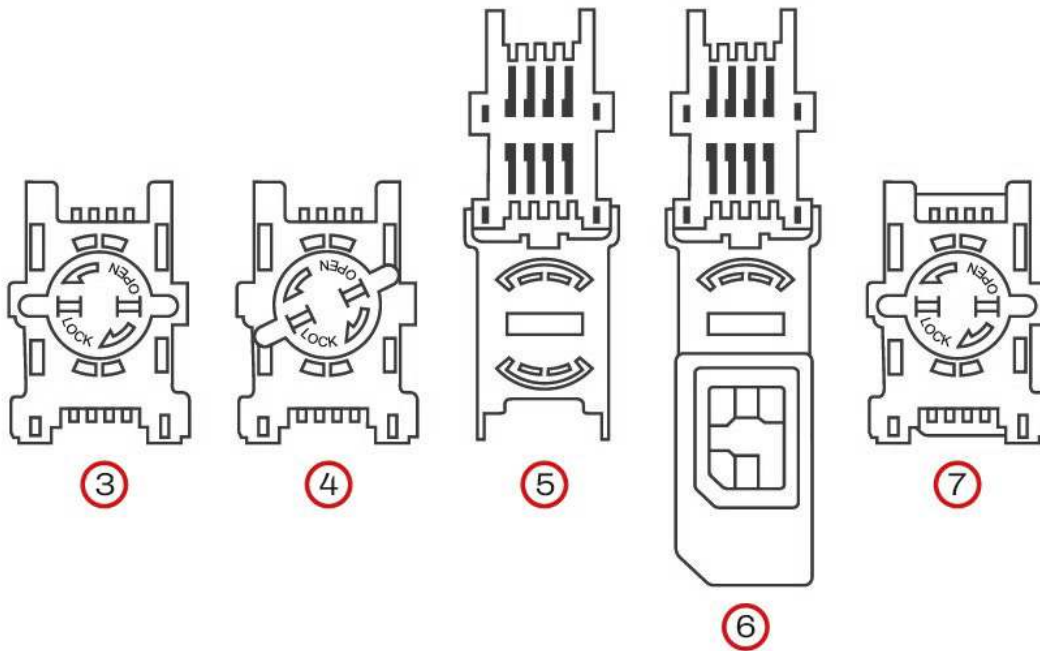

1.2.6 Aranet PRO Plus power options

Aranet PRO Plus is powered by 802.3af PoE directly from the PoE enabled Ethernet switch or using optional active PoE injector PN TDAPOE03.

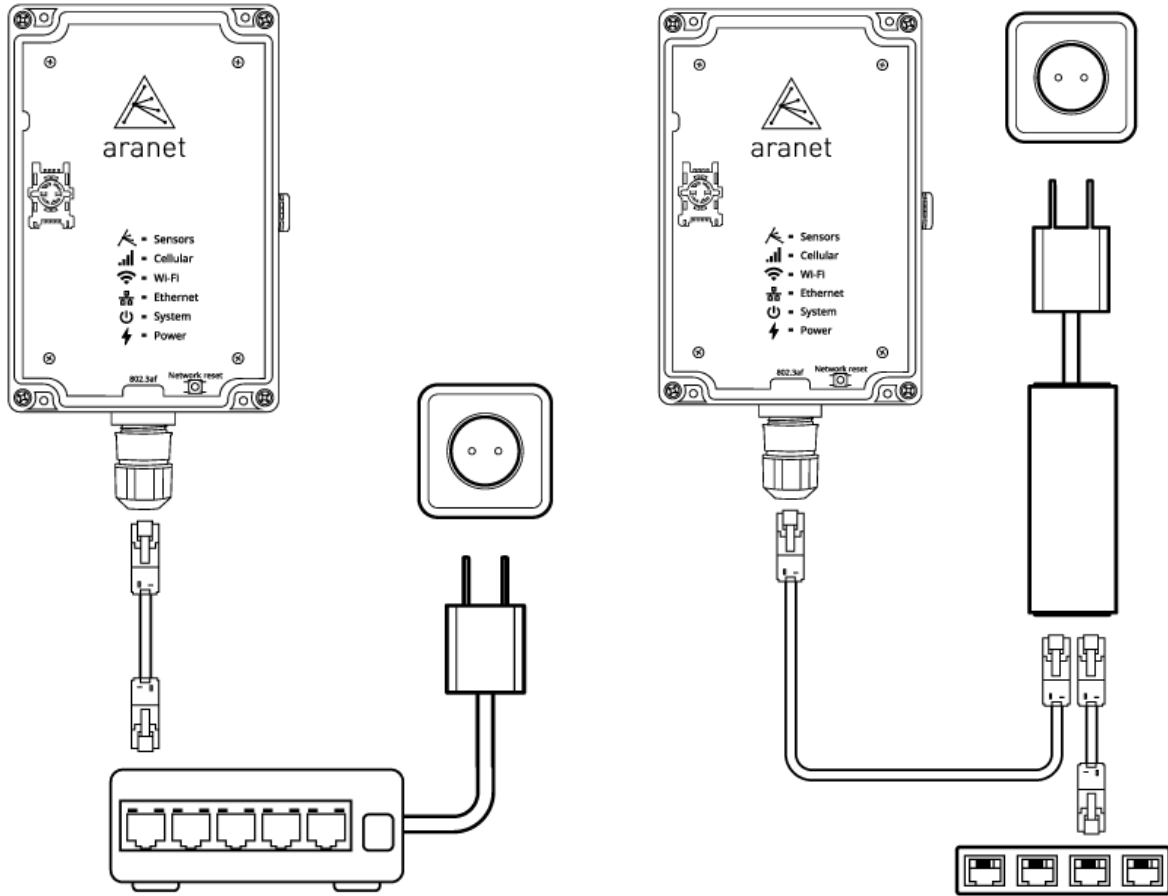

1.2.7 Emergency switching off

Aranet PRO Plus can shut down and switch off safely in case of main power failure. System notification will be sent as email and/or SMS to the destination configured by users belonging to the Administrator group.



!WARNING! ARANET PRO Plus BASE STATIONS CONTAIN CR2032 TYPE BATTERY. RISK OF DAMAGE IF BATTERY IS REPLACED BY AN INCORRECT TYPE. THE USER IS RESPONSIBLE FOR DISPOSAL OF BATTERIES ACCORDING TO THE STATE LEGISLATION.

1.3 ARANET PRO/PRO Plus SPECIFICATIONS

	Aranet PRO	Aranet PRO Plus	Aranet PRO Plus LTE
Part Number (P/N)	TDSBWB01, TDSBWBU1, TDSBWBC1, TDSBWPA1.xxx, TDSBWPA2.xxx, TDSBWPC2.xxx	TDSBOA03, TDSBOAU3, TDSBOAC3	TDSBOB03, TDSBOBU3, TDSBOBC3
Maximum sensor count*	100/50/12		
Alarm type	Email		
Optional alarm	SMS notification through external USB modem	N/A	SMS notification
Memory	10 years of measurements of 100 sensors**		
Receiver sensitivity	-127 dBm		
Channels – Europe EU868	Channel 1: 868.10 MHz		
	Channel 2: 868.30 MHz		
	Channel 3: 868.50 MHz		
Channels – Americas US920	Channel 1: 917.3 / 922.9 MHz		
	Channel 2: 917.5 / 923.1 MHz		
	Channel 3: 917.7 / 923.3 MHz		
	Channel 4: 917.9 / 923.5 MHz		
Channels – Russia RU869	Channel 1: 868.85 MHz	N/A	
	Channel 2: 869.05 MHz	N/A	
Channels – Asia AS923	Channel 1: 923.1 MHz		
	Channel 2: 923.3 MHz		
User interface	Aranet SensorHUB		
Interface accessibility	PC, tablet, or smart phone connected via Ethernet cable or local Wi-Fi connection		
Interface languages	English, French, Spanish, Nederland, Russian, Latvian, German, Portugal		
Temperature scale	Celsius, Fahrenheit, Kelvin		
Data protection	Password protected user accounts, encryption for data		
Communication	Ethernet cable, local Wi-Fi (2.4 GHz)	Ethernet cable, local Wi-Fi (2.4 GHz),	Ethernet cable, local Wi-Fi (2.4 GHz) GSM LTE 4G

Browser compatibility	Latest versions of Chrome Safari Edge		
Power options	AC/DC power adapter	PoE 802.3af	
	Optional power supply with Passive 12V PoE injector	Optional PoE injector P/N TDAPOE03	
	Built-in battery (backup power up to 30 min)	Supercapacitors for safe shutdown	
Operating temperature	0°C to 40°C / 32°F to 104°F	-40 °C to +60 °C / -40 °F to 140 °F	
Operating humidity	0% to 100% non-condensing		
Dimensions	107x170x26 mm / 4.2x6.7x1.02 in w/o mounting bracket	180 x 120 x 45 mm / 7.09 x 4.72 x 1.77 in	
Ports	12VDC power port, 1 x Ethernet, 1 x USB A	1 x Ethernet	
SIM-card	N/A	N/A	1 x Mini size
Weight	190g/ 6.7oz w/o mounting bracket	250 g /(8.8 oz	
Construction	ABS Plastic, steel mounting bracket	PC plastic	
Protection class	IP42	IP67	
CE / FCC / IC Marking	Yes	CE	
Included	AC/DC power adapter, mounting bracket	Cat.5 Ethernet cable 1 m	
Additional – Europe	Aranet MINI can be used as a monitor		

* Depending on license purchased

** Aranet4 PRO sensor with 5-minute TX interval chosen for calculation.

2 INITIAL SETUP

2.1 Initial setup of Aranet PRO/PRO Plus

Aranet PRO/Aranet PRO Plus can be configured with built-in Wi-Fi Access Point or with Ethernet connection to local network. This allows quick and easy access to Aranet PRO using any personal devices like PC, tablet, or smartphone.

Aranet PRO/Aranet PRO Plus base station Network factory settings are:

- Wi-Fi interface configured as Access Point:
 - SSID - "Aranet-*****" (refer to the label attached to Aranet PRO/PRO Plus); Encryption – WPA2-PSK-CCMP;
 - **Aranet PRO Mk2** SSID - "Aranet-*****" Encryption – None;
 - IP address – 192.168.206.100;
 - Subnet Mask – 255.255.255.0
- Ethernet Interface:
 - DHCP client – On;
 - Static IP fallback – On;
 - IP address – 192.168.205.100;
 - Subnet Mask – 255.255.255.0



2.1.1 Initial setup of Aranet PRO/PRO Plus using built-in Wi-Fi Access Point

Aranet PRO/Aranet PRO Plus setup using built-in Wi-Fi Access Point is the easiest way to start working.

- (1) **Aranet PRO Plus:** Interconnect base station using Ethernet cable with the port of the PoE injector TDAPOE03 marked as "OUT" or a port of a PoE-enabled switch. Wait until LED indicators "Power", "System", and "Wi-Fi" turn On.



Aranet PRO: Plug in included AC power adapter jack and switch base on using On-Off switch. Wait until LED indicators next to "12V" and "Wi-Fi" turn on and wait for another 30 seconds.

- (2) Using a smartphone or a PC open its Wi-Fi network settings and find new wireless network access point called "Aranet-*****". Connect to it using password from the label.



Aranet PRO Mk2 – connect without password.

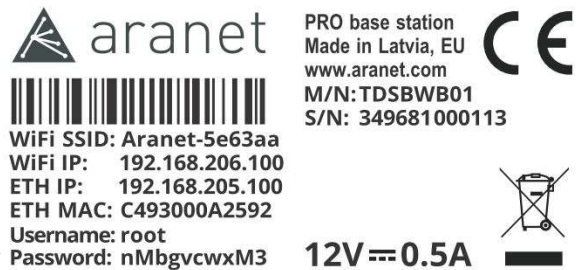

- (3) Open internet browser and type in the URL bar IP address: 192.168.206.100
- (4) You should now see the Aranet PRO/Aranet PRO Plus login screen (refer to chapter [2.1.3 Initial Login and Fast Settings](#) of this manual).

2.1.2 Initial setup of Aranet PRO/PRO Plus using Ethernet cable

I. Aranet Pro connection to Local Network (LAN) with working DHCP server

- (1) **Aranet PRO Plus:** Plug in Ethernet cable connected to powered PoE enabled switch or powered PoE insert TDAPOE03 “OUT” terminal; plug in another Ethernet cable to PoE insert “IN” terminal and connect it to LAN Ethernet switch (router).

Wait until LED indicators “Power”, “System”, and “Ethernet” turn On.

Aranet PRO: Plug in Aranet PRO into power source using the AC power adapter and plug in the Ethernet cable that connects Aranet PRO into local network (Router or Ethernet Switch) Wait until LED indicators next to “12V” and “Wi-Fi” turn on and wait for another 30 seconds.

- (2) Search for new IP-address assigned to Aranet PRO/Aranet PRO Plus by DHCP server. You can consult your local network administrator or scan your local network with any Network scanner.
- (3) Open internet browser and type in the URL bar discovered in the previous step IP address.
- (4) You should now see the Aranet PRO/Aranet PRO Plus login screen (refer to chapter [2.1.3 Initial Login and Fast Settings](#) of this manual).

II. Aranet PRO/Aranet PRO Plus connection to PC

- (1) **Aranet PRO Plus:** Plug in Ethernet cable (connected to powered PoE insert TDAPOE03 “OUT” terminal; plug another Ethernet cable to PoE insert “IN” terminal and connect it directly to your PC. Wait until LED indicators “Power”, “System”, and “Ethernet” turn On.

Aranet PRO: Plug in included AC power adapter jack and switch base on using On-Off switch, plug in Ethernet cable that connects Aranet PRO directly to your PC. Switch Aranet PRO on. Wait until LED indicators next to “12V” and “LAN” turn on and wait for another 30 seconds.

- (2) Make sure the PC is not connected to any Wi-Fi Internet connections.
- (3) For Windows 10, in the Control Panel menu navigate to **Control Panel >Network and Internet >Network and Sharing Center**.
- (4) Click “Change adapter settings”.
- (5) Right-click on “Local Area Connection” and click on “Properties”.
- (6) Select “Internet Protocol Version 4 (TCP/IPv4)” and click on “Properties”.
- (7) Select “Use the following IP Address”, set IP address to 192.168.205.101 and subnet mask to 255.255.255.0, leave rest of the fields blank and press “Save”.
- (8) Open the Internet browser and in URL bar type the IP address of Aranet PRO/PRO Plus: 192.168.205.100
- (9) You should now see the Aranet PRO/PRO Plus login screen (refer to chapter [2.1.3 Initial Login and Fast Settings](#) of this manual).

PRO
PRO+

PRO
PRO+

2.1.3 Initial Login and Fast Settings

Username and password for login can be found on the label attached to Aranet PRO/PRO Plus (see example below).

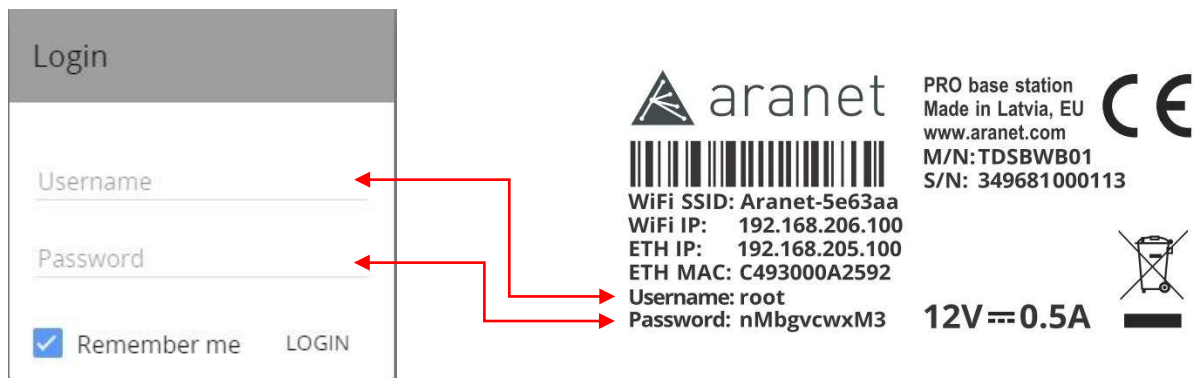

Aranet PRO Mk2:

Username: *root*

Password: *changeme*



!NOTE! **Root** is an administrator account. For security reasons, we recommend changing the password as soon as possible.

We also recommend creating separate accounts for users as required. There are two levels (groups) of access – **user** and **administrator**. **User** group accounts have read-only permissions, can only view parameters, and can subscribe to notifications. The total account limit is 20 (including **root** account).

After entering Username, Password and clicking **LOGIN** button for the first time, following page will open:

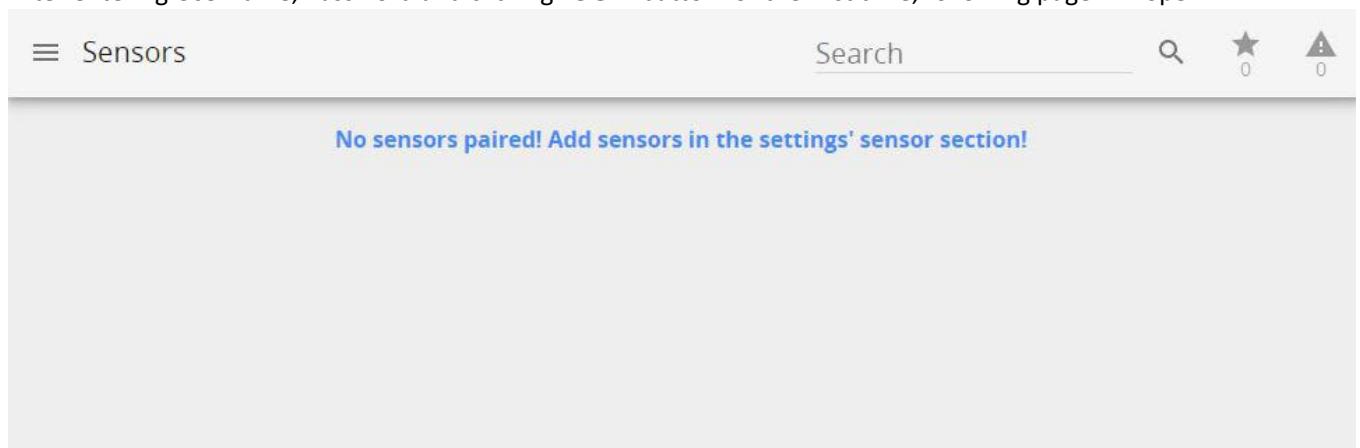

Now you can change the regional, network, and other settings, as well as start pairing the sensors. Refer to [chapter 3.2 ARANET SENSORHUB OVERVIEW](#) for detailed information about Menu.

It is a good practice to start with **System** settings.

Click with your mouse to the **Menu** icon  to open **MAIN** menu and select **System**:

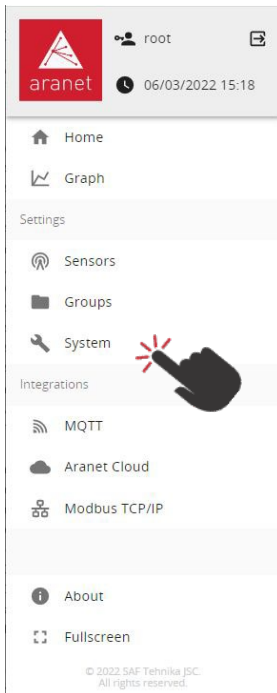

Navigate to **Region** menu and set your preferred *Language, Units, Time, and Data* formats. Click **Save** 

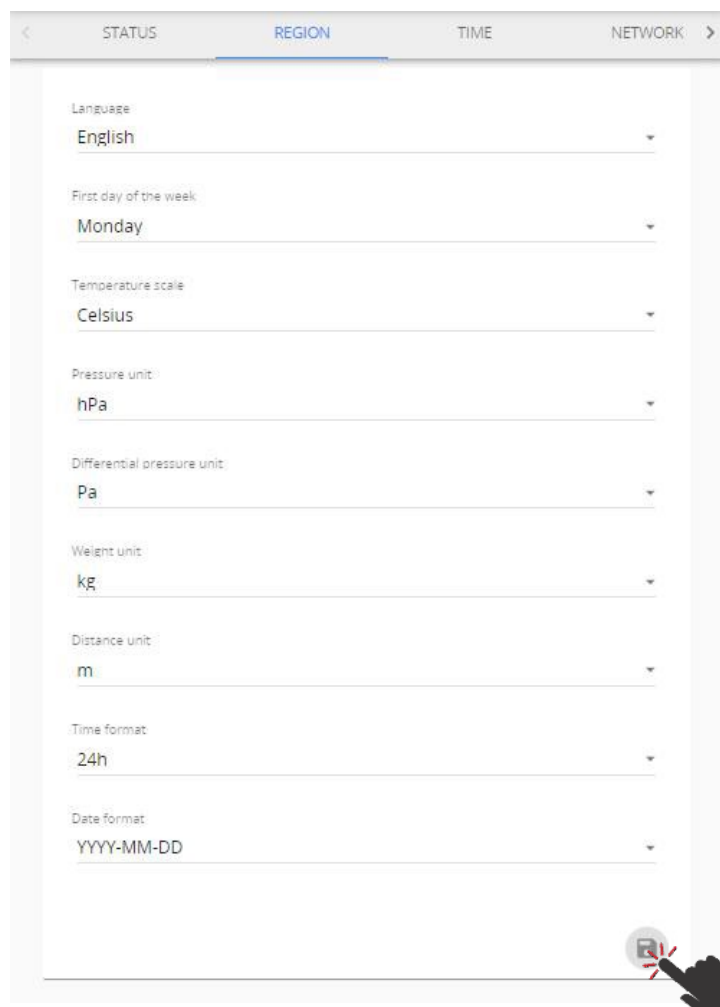

Navigate to **Time** menu and set time *manually, synchronize with your PC or NTP*. Click **Save** .

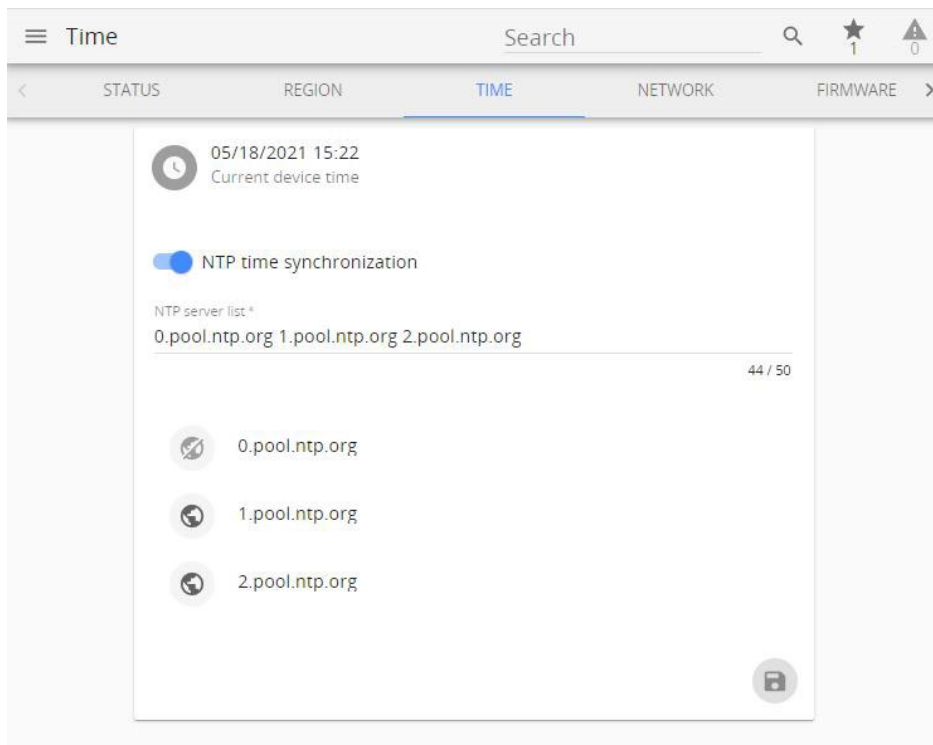

Navigate to **Firmware** menu.

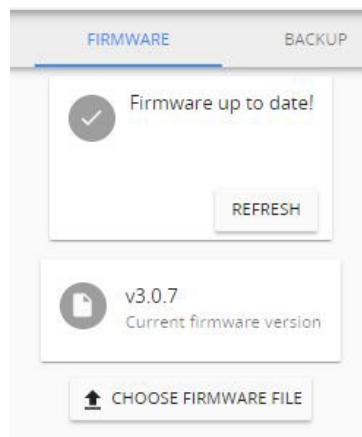

It is highly advised to install the latest firmware for your Aranet PRO/PRO Plus base. Visit aranet.com/downloads/ to download the latest firmware version and upgrade your device if it has older firmware version installed. Refer to this document chapter [3.6.5 Firmware menu](#) for upgrade instructions.

Navigate to **Radio** menu.

It is advised to scan radio channels for better availability before pairing the sensors because of possible interference from other devices using same frequency range that might be installed near to your location. Be patient, it is long-lasting process and can take up to 3 hours. You can skip scanning by now and select channel at your desire, but this can lead to less good communication between sensors and Aranet PRO/PRO Plus base.

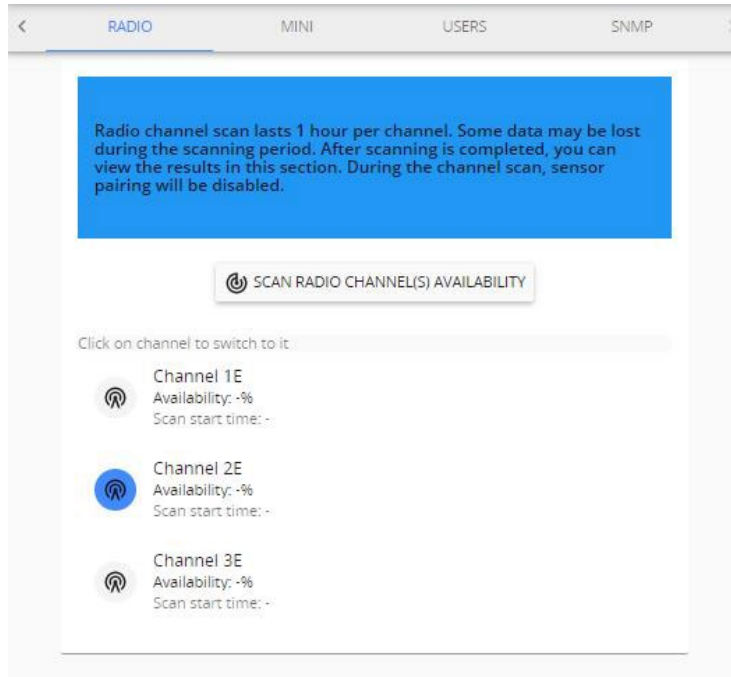

!NOTE! Keep in mind: you will have to repeat all sensors pairing process if you decide to change radio channel.

You can leave **System** menu now and switch to **Sensors** menu for sensors pairing.

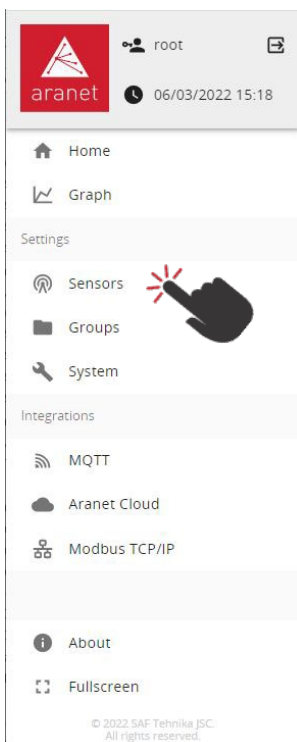

2.2 Pair sensors to Aranet PRO /PRO Plus

Aranet PRO/PRO Plus supports several types of sensors. To connect them to the system the same steps apply for all types of sensors. Sensors can be paired by-one or in batch.

When pairing the sensor, it should be physically located within around 20 meters of Aranet PRO/PRO Plus.

- (1) Open the battery compartment of sensor, see example image below. While holding with one arm the plastic cup, turn clockwise the main plastic body of the sensor (do not remove or twist the cable).

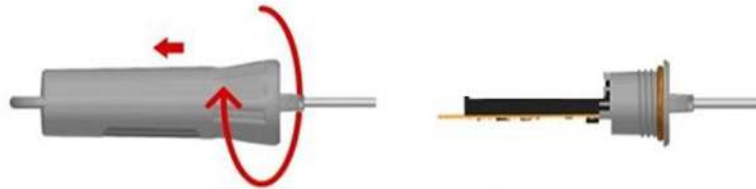

Most other sensors have visible battery compartment or screws on the body. Loosen the screws to take out the lid and expose battery compartment. Take out battery(ies) from the sensor(s) you want to pair. If there are two batteries in the battery compartment, it is enough to take out one.



!NOTE! When pairing **Aranet4 PRO** sensor, make sure that “Radio” switch is in ON (upper) position:



- (2) Log in to Aranet PRO/PRO Plus web-interface using an account with Administrator rights
- (3) Navigate to Aranet PRO/PRO Plus Main menu
- (4) Choose “Sensors” menu

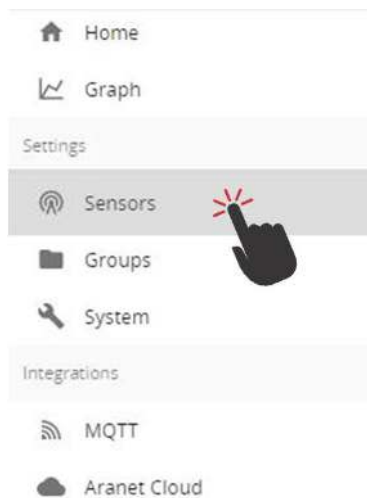

- (5) Set the Measurement interval (10, 5, 2 or 1 minute).
- (6) Click “PAIR SENSOR” button to initiate pairing for a sensor.

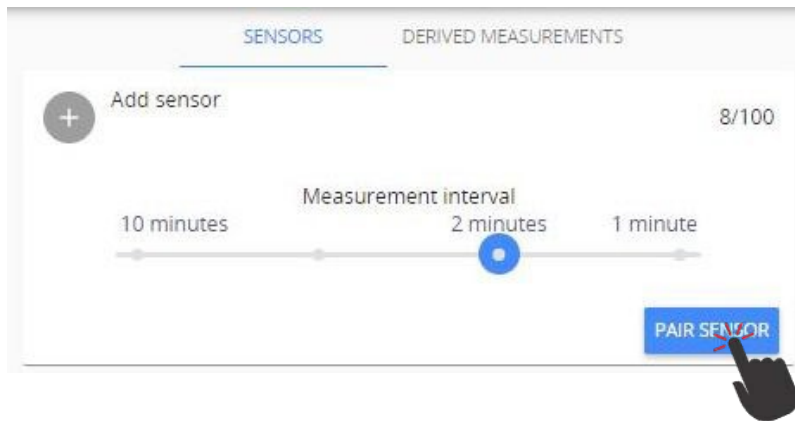

2-minute timer indicated by closing ring is started:

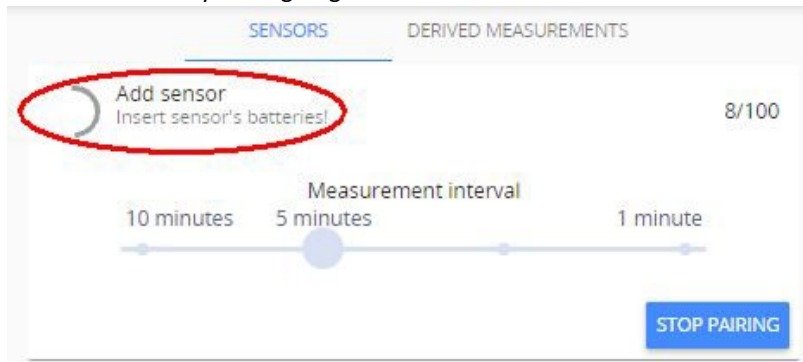

- (7) Insert sensor's battery(ies) by observing the correct polarity. Refer to datasheet of respective sensor for information on supported battery types.
- (8) Red LED light will flash on the sensor. Three short flashes followed by a long flash will signal a connection failure, the pause between flashes will be the same. In case of successful pairing the long flash will follow immediately after a short flash. Observing the LED light indications can save time while pairing sensors, however, Aranet PRO/PRO Plus software will also display successfully paired sensor in the sensors list: new sensors are indicated by green triangle. Sensor pairing process usually lasts 10-15 seconds but can be prolonged up to 30 seconds.



Each time new sensor is successfully paired, 2-minutes timer is restarted. If sensor pairing was not successful within 30-seconds period, take out battery from the sensor, wait 10 seconds and place battery back to repeat pairing process. When you finish pairing all sensors, press "STOP PAIRING" button or wait for the timer to close pairing process automatically.

- (9) After successful pairing, close the battery compartment of sensor(s).

(10) Now you can rename the sensor(s), set thresholds for alarms, add it(them) to *favorites*, etc. After completing your tasks click **Save**  button for every modified sensor.

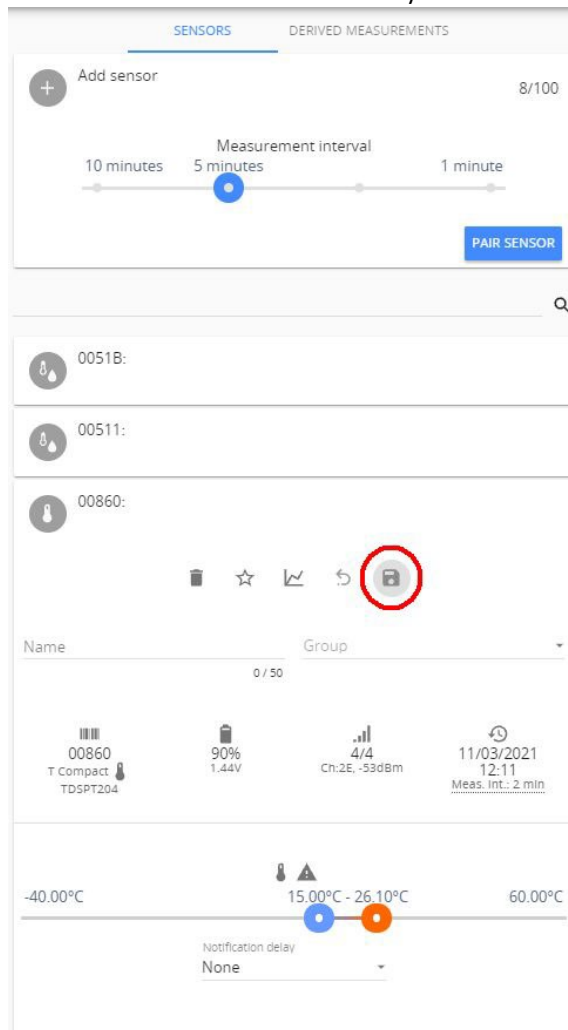

You have now paired sensors to Aranet PRO/PRO Plus and can place it in the desired location.

All paired sensors appear on the **Home** page of SensorHUB:

Sensors		Search		★ 1	▲ 0
⌵	⬇	Name	Group		
22.9°C	43%	0051B		🗑️	★
22.1°C	37%	00511		🗑️	★
21.6°C		0089D		🗑️	★
21.1°C		00860	Group 1	🗑️	★
20.4°C	40%				
558 ppm		003E6	Group 1	🗑️	★
1017 hPa					

The fast set-up process is finished.

2.3 Connecting Aranet PRO/PRO Plus to internet network

Additional features like network time synchronization (NTP), reporting and alarm notifications using e-mail, connection to Aranet Cloud etc. require connectivity to Internet (or internal data (Local) network).

Connection to Local Area Network (LAN) and Internet using Ethernet cable is preferable, however connection using Wi-Fi and LTE is also possible.

2.3.1 Connecting Aranet PRO/PRO Plus to internet network using Ethernet cable

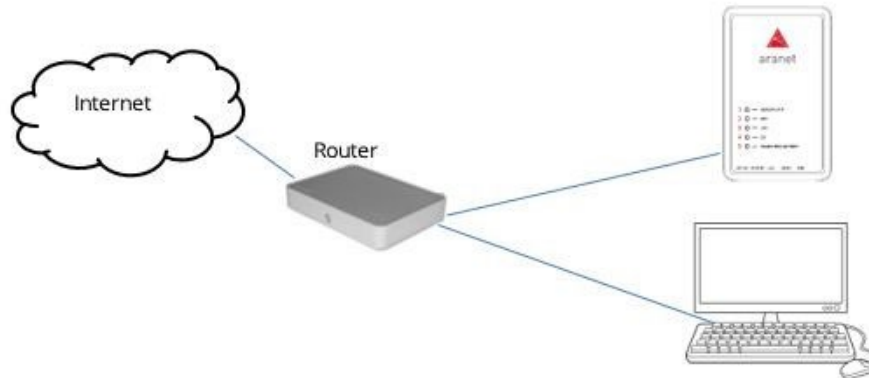

If during initial setup process you connected your Aranet PRO/PRO Plus to [Local Network with working DHCP server](#), most probably Aranet PRO/PRO Plus is connected to Internet already. Consult your network administrator to be sure.

If you are connected to Aranet PRO/PRO Plus using its [built-in Wi-Fi Access Point](#), you should change Ethernet settings on Aranet PRO/PRO Plus in following way:

(1) Navigate to **SYSTEM > NETWORK** and select **ETHERNET** tab



(2) **Aranet PRO Plus:** Interconnect Aranet PRO Plus base station with the port of the PoE injector TDAPOE03 marked as "OUT" or a port of a PoE-enabled switch. Wait until the LED indicator "Ethernet" turns On. Wait until LED indicator "Ethernet" turns On.

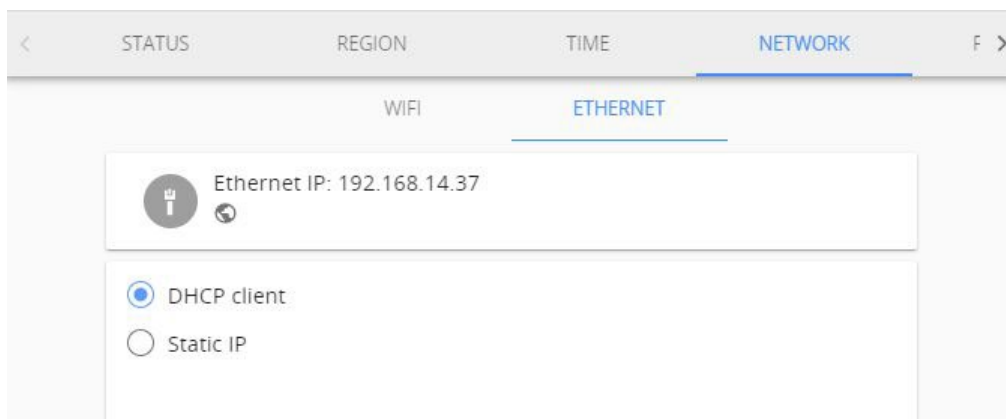

Aranet PRO: Connect Aranet PRO LAN port to external router (or Switch) LAN port using Ethernet cable. Check if the LED indicator next to "LAN" is On.

(3) As factory setting, Aranet PRO/PRO Plus DHCP client is ON. If there is working DHCP server in the network (as usually is when connecting to router), Aranet PRO/PRO Plus will receive new IP address automatically. While connected to Aranet Wi-Fi, you can verify new Ethernet IP address assigned by external router like shown in the picture below. Note the **globe**  symbol is not crossed, which indicates successful connectivity to the Internet.



In case of static IP, select **Static IP** and fill in all needed fields: *IP address, Subnet Mask, Default gateway* and *DNS server*, **example** is shown in the picture below, and click **Save** . Consult your network administrator for these parameters in your local network.

WIFI ETHERNET

 Ethernet IP: 192.168.20.130 



DHCP client
 Static IP

IP address*
192.168.20.130

Subnet mask*
255.255.255.0

Default gateway
192.168.20.1

DNS Server
192.168.20.1

MAC: C4:93:00:13:00:07



Note! DHCP is a dynamic protocol for IP address assignment. There might be occasions when the DHCP server's assigned IP address for Aranet PRO/PRO Plus Ethernet port is changed. Consult your network administrator or refer to the user manual of the external router on how to always reserve the same IP address assigned to the Aranet PRO/PRO Plus Ethernet port (MAC address).

2.3.2 Connecting Aranet PRO/PRO Plus to internet network using local Wi-Fi network

In case you wish to connect your Aranet PRO/PRO Plus to your local Wi-Fi network, you should change Wi-Fi settings on Aranet PRO/PRO Plus in following way:

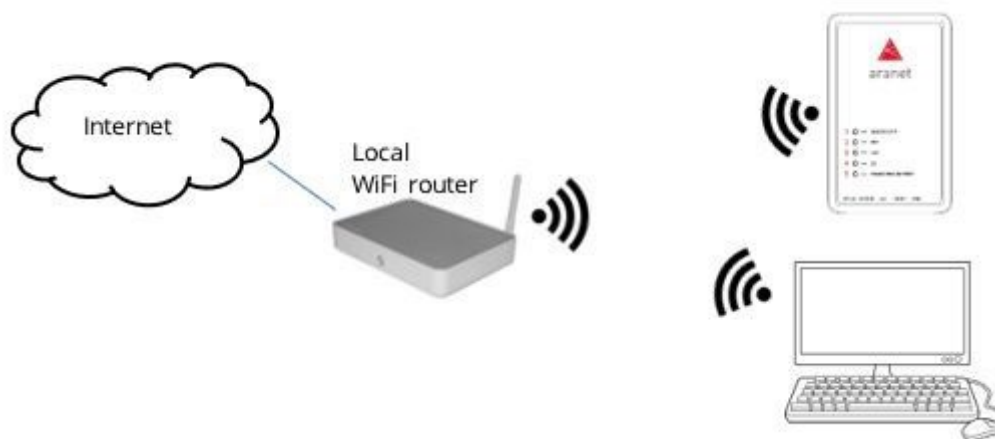

- (1) Navigate to **SYSTEM > NETWORK** and select **WIFI** tab
- (2) Choose the “**Client**” mode (see picture below).
- (3) Under “Select from this list or input manually” find name of your local Wi-Fi network
- (4) Choose the required **Encryption**
- (5) Fill in the Wi-Fi password (if required)
- (6) Write down the MAC-address of the W-Fi interface (12 symbols separated by semicolon)
- (7) Click on  to save the settings



!NOTE! Most Wi-Fi routers have DHCP enabled by default, we recommend keeping this setting for ease of set up. For advanced users, however, static IP address set up is possible.

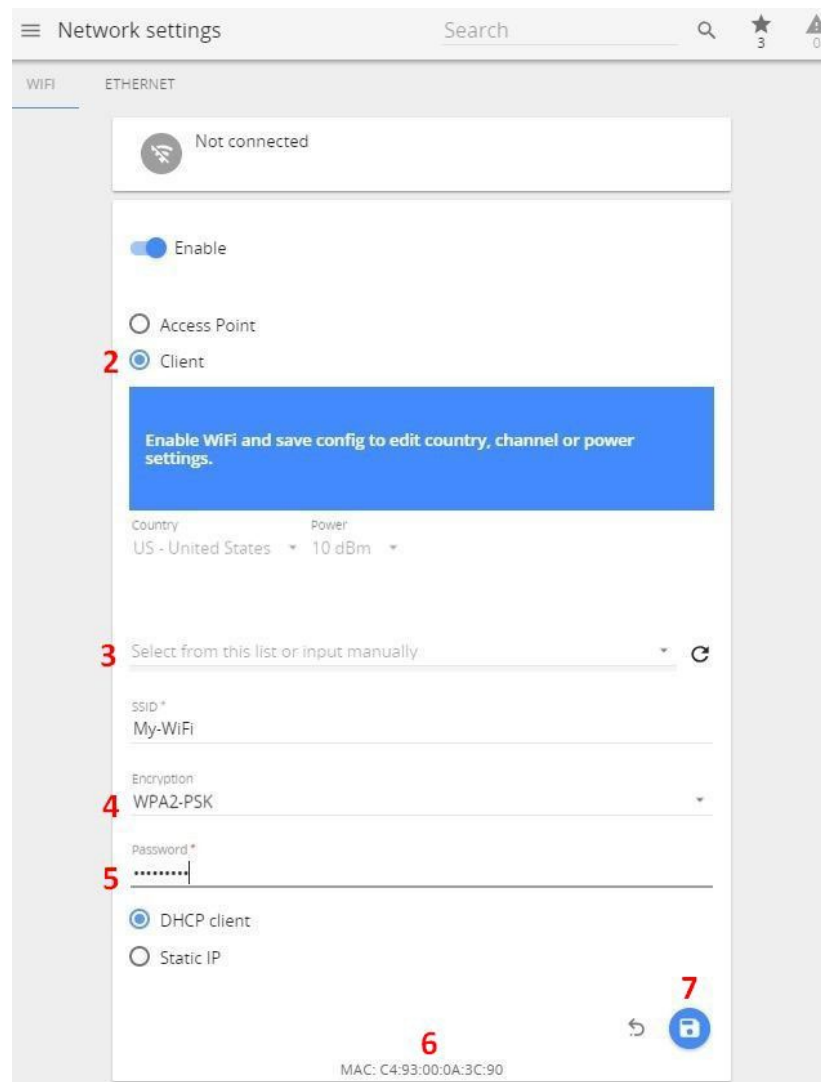

- (8) After the new Wi-Fi settings on Aranet PRO/PRO Plus are saved, web page will reload, and new IP address will be assigned to the base by the external Wi-Fi router. **If you were connected to the base using its Wi-Fi Access Point, your connection to the base will be lost.**
- (9) Connect your PC to the same Wi-Fi network you had choose at p. (3).
- (10) Wait for base station to load (observe its LED indicators)
- (11) Consult your network administrator about the IP-address assigned to the base by local DCHP server or use any Network Scanner to find it.
 Here is shown as example “Advanced IP-scanner” for Windows (<https://www.advanced-ip-scanner.com/download/>); Mac users can use f.e. LanScan (<https://apps.apple.com/us/app/lanscan/id472226235>)
- a Launch scanner and press “IP” button to select the range of network your PC is connected to.
 - b Press “Scan” button to start the scanning
 - c Wait for the scanning to complete and locate the MAC address you wrote down at p. (6) in “MAC Address” column
 - d The address in the column “IP” is the one assigned to Aranet PRO/PRO Plus base.

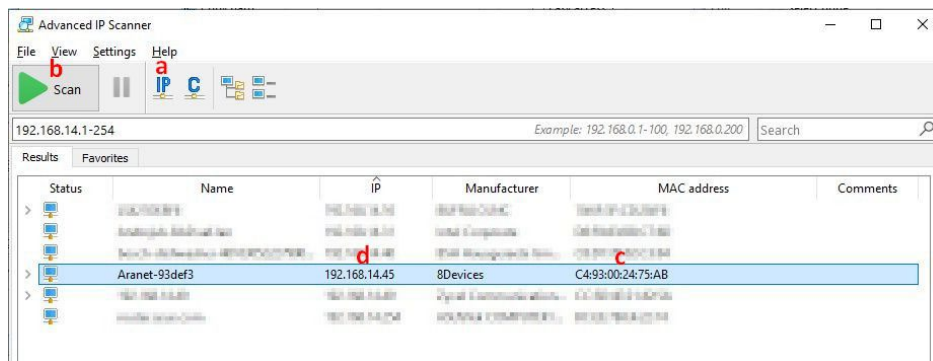

(12) Type in this IP address into the browser URL field and login to Arant PRO/PRO Plus.

Note the globe symbol  is not crossed, which indicates successful connectivity to the Internet.

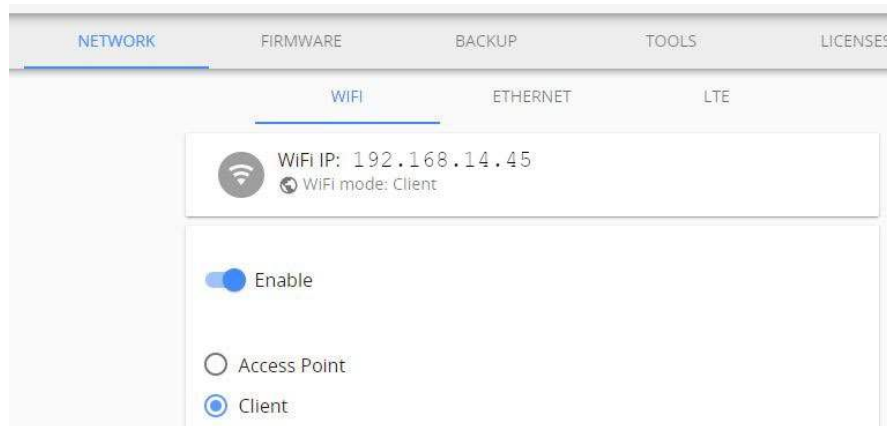



!NOTE! Most Wi-Fi routers have DHCP enabled by default, we recommend keeping this setting for ease of set up. For advanced users, however, static IP address set up is possible.

2.3.3 Connecting Aranet PRO Plus LTE to internet network using LTE Modem



Aranet PRO Plus LTE P/N TDSBOB03, TDSBOBU3, TDSBOBC3: LTE menu is visible when modem is detected by the system. Mini size GSM SIM-card with valid Mobile Internet contract must be inserted into the modem to ensure its functionality. SIM-card is not included in the Aranet PRO Plus LTE scope of delivery. It is customer's duty to sign the contract for Mobile Internet connection usage. Using Mobile Internet can cause additional expenses not covered by Aranet PRO Plus LTE manufacturer.

Please consult your Mobile Internet provider for data to fill out connection configuration fields.

- (1) Enable LTE connection
- (2) Fill out APN (mandatory) and other fields (if required)
- (3) Click on  to save the settings
- (4) Wait for the settings to take effect, page reload may be required. Successful connection will be indicated by IP address assigned to the base and **Globe**  symbol with no crossover:

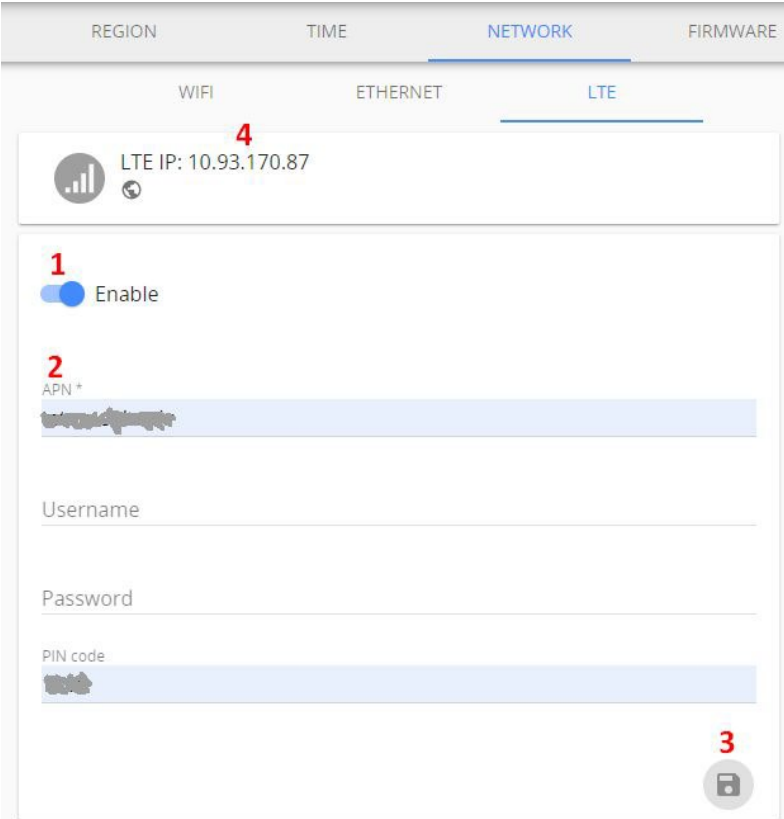

The screenshot shows the 'NETWORK' configuration page for the Aranet PRO Plus LTE device. The 'LTE' tab is active, and the 'Enable' toggle is turned on. The APN field is filled with a value. The Username, Password, and PIN code fields are empty. A save icon is visible in the bottom right corner. A red '4' is placed above the LTE IP address, and a red '1' is placed above the 'Enable' toggle, a red '2' above the APN field, and a red '3' above the save icon.

It is possible to access Aranet PRO Plus LTE web interface from internet over LTE connection. For this purpose, please contact your Mobile Internet provider and request *static* IP-address for the SIM-card inserted into modem.



!NOTE! LTE connection configuration with *static* IP-address may differ from one with dynamically assigned IP-address. Please consult your Mobile Internet provider for details.

2.4 Accessing the Aranet PRO/PRO Plus from Internet

For remote access to Aranet PRO/PRO Plus from Internet, public (fixed, static) IP address is required.

While all Aranet PRO/PRO Plus network interfaces can be used for accessing the base from Internet, **Ethernet interface is most preferable option for this purpose.**

IP address is assigned to selected Aranet PRO/PRO Plus network interface as a Static IP address. Refer to chapter “**Network**” and corresponding interface menu section.

In case you have a router (fixed or mobile) with already available fixed IP address, you can use port forwarding feature on your router to setup an access to Aranet PRO/PRO Plus. Port forwarding is configured on your router. Refer to the User Guide of your router on how port forwarding should be configured.

Below is example of possible configuration.

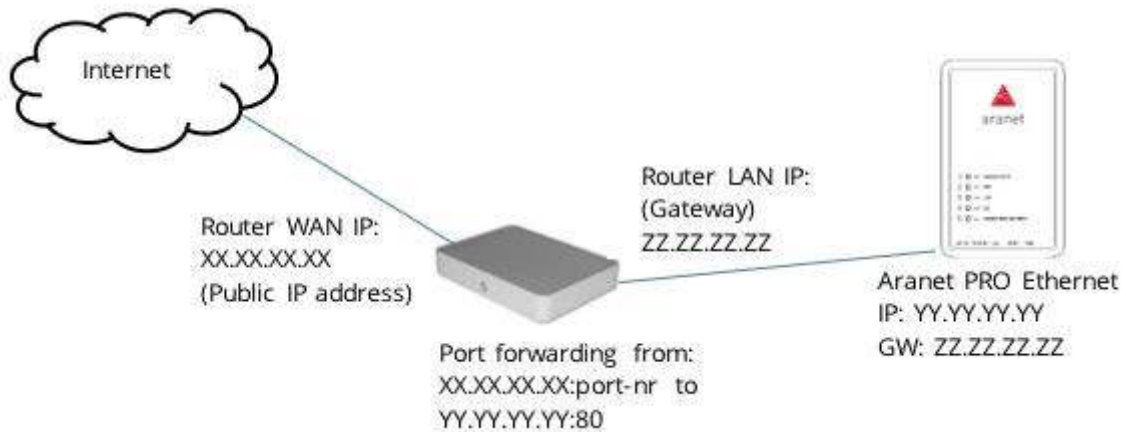

For accessing Aranet PRO/PRO Plus, open the Internet browser and in URL bar type the IP address with port number, xx.xx.xx.xx:port-nr (for instance, 213.100.100.1:8100).

These were the main steps needed for monitoring your sensors data. To make monitoring more convenient and illustrative, you can create **Graphs**, set up **Sensor Groups** and alarms, **Notifications** sending, etc. For instructions, please read corresponding chapter in following [ARANET SENSORHUB OVERVIEW](#).

It is also possible to enable Aranet sensor data upload to **Aranet Cloud** - Plug & Play Cloud solution for Aranet IoT ecosystem.

3 ARANET SENSORHUB OVERVIEW

3.1 Main navigation bar

The main navigation bar contains the icon for *main menu*, indication of page you are viewing, a *search box*, *favorite*, and *alarm* filter icons.

The search box allows you to quickly locate paired sensor or sensor group from any location of the menu page.

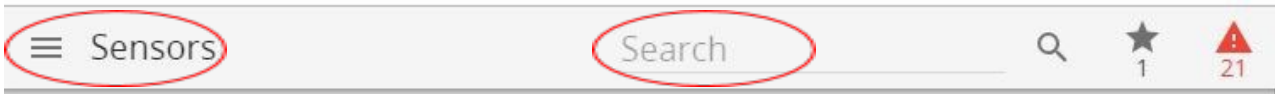

For filtering, type in the Search bar any of following characteristics of sensor you are looking for:

- Name of sensor
- Sensor ID
- Group of sensors

The *favorite* ★ icon allows you to quickly access all the sensors you have added to your favorite lists. Each user account has its own favorite list.

The *alarm* ⚠ icon allows you to quickly see a list of all sensors that have current alarms and may need attention.

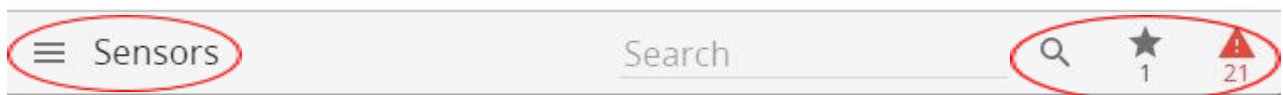

3.2 Main menu

Main menu contains following sections - **Home, Graph, Sensors, Groups, System, MQTT, Aranet Cloud, Modbus TCP/IP.**

From these sections you can navigate to all options of the Aranet PRO/PRO Plus software.

General information about the user login, current device time and date as well as log off option are displayed here. As well for better visibility, you can choose Fullscreen mode.

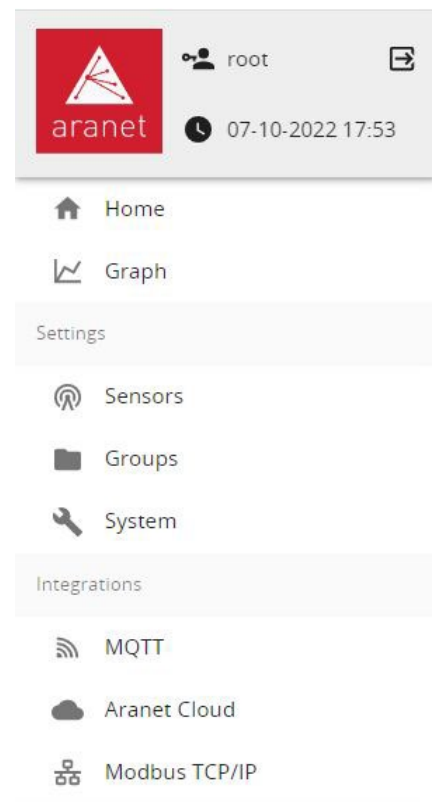

The “**Home**” menu is the main monitoring page that lists all the added sensors. Sensor information is updated in real time.

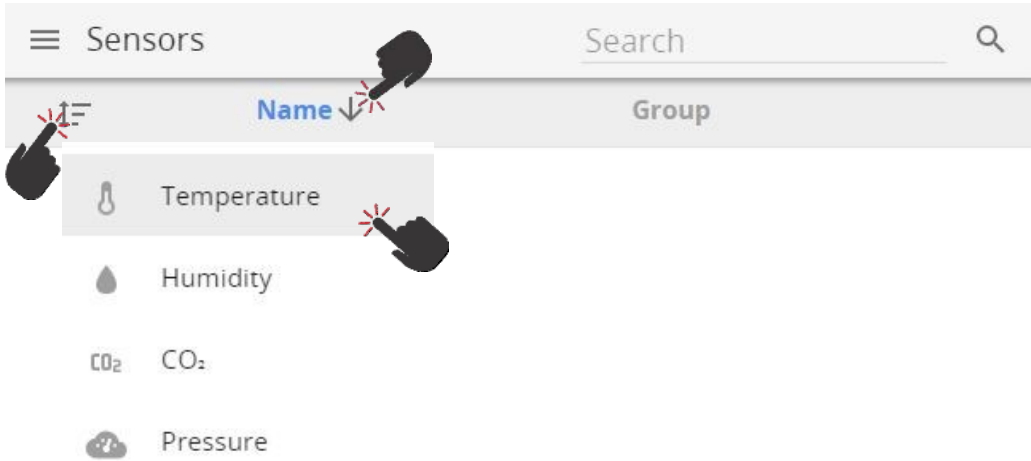

It is possible to arrange the sensors by highest or lowest measurement values, by name or by group.

Click on the **Sort** button  to open a sub-menu of measurement types. Click on a measurement type to sort by this measurement and hide sensors which do not provide it. Clicking on "Name" or "Group" will list all sensors.



Click on  to sort by name or value in descending order. Click on  to sort by name or value in ascending order.

By selecting respective sensor, a submenu opens with sensor information (sensor serial number, type, name, group, thresholds, last time data was received, battery level, signal strength).

All changes for sensor settings can be adjusted here. Selecting *Graph* icon will open Graph screen for respective sensor.

Favorite icon  enables a user to add/remove the sensor as a favorite.

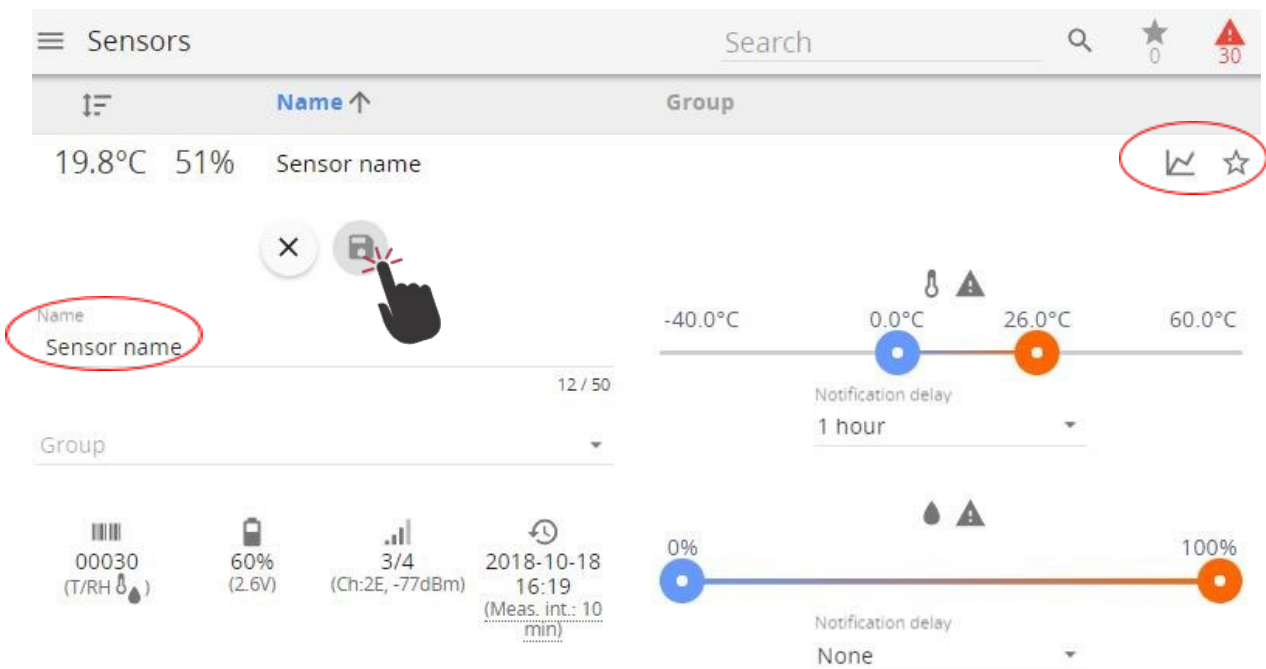

Notification delay allows the user to define a delay for the sending of the exceeded threshold alarm notifications. Please refer to [3.6.9 Notifications](#) for further information.

3.3 Graphs

Graphs screen enables user to view, compare and analyze the data from the sensors. The “**Graph**” page enables user to look at historical data, patterns, and changes, as well as compare multiple sensor readings over time to see potential correlations.

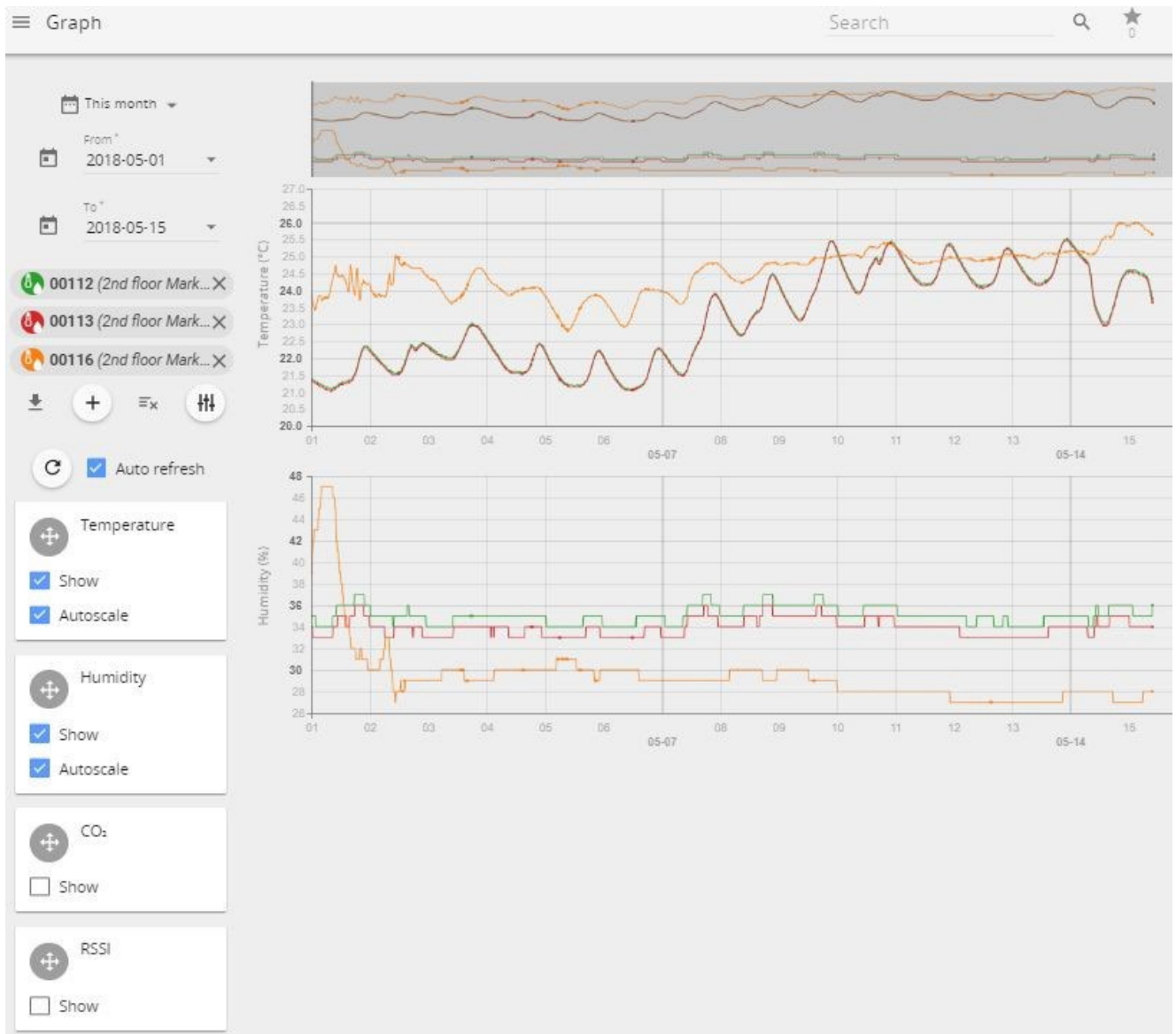

- (1) By pressing icon **+** add up to 20 sensors at once for analysis one by one or use icon **+≡** to add first 20 sensors at once.
- (2) Choose which values to graph depending on the attached sensor and receive as much information as needed.
- (3) Set custom period to look for historic data analysis.
- (4) Export data to *.xlsx*, *.csv*, *.png* or *.svg* files by using **Download** **↓** button.

Use **Tune** **≡** button to open a sub-menu allowing user to select or deselect additional parameters to display on graphics (received signal strength level RSSI, battery level, and others).

On a computer the timeline zoom-in and zoom-out can be done using mouse scroll wheel while mouse pointer is positioned in the graph area (some application requires holding down the **Control** button (**ctrl**) while scrolling the mouse wheel).

On a smartphone device it is possible to use multi touch and panning function with two fingers for navigation. Positioning the cursor on specific point on the graph, detailed information about measurement reading will be displayed.

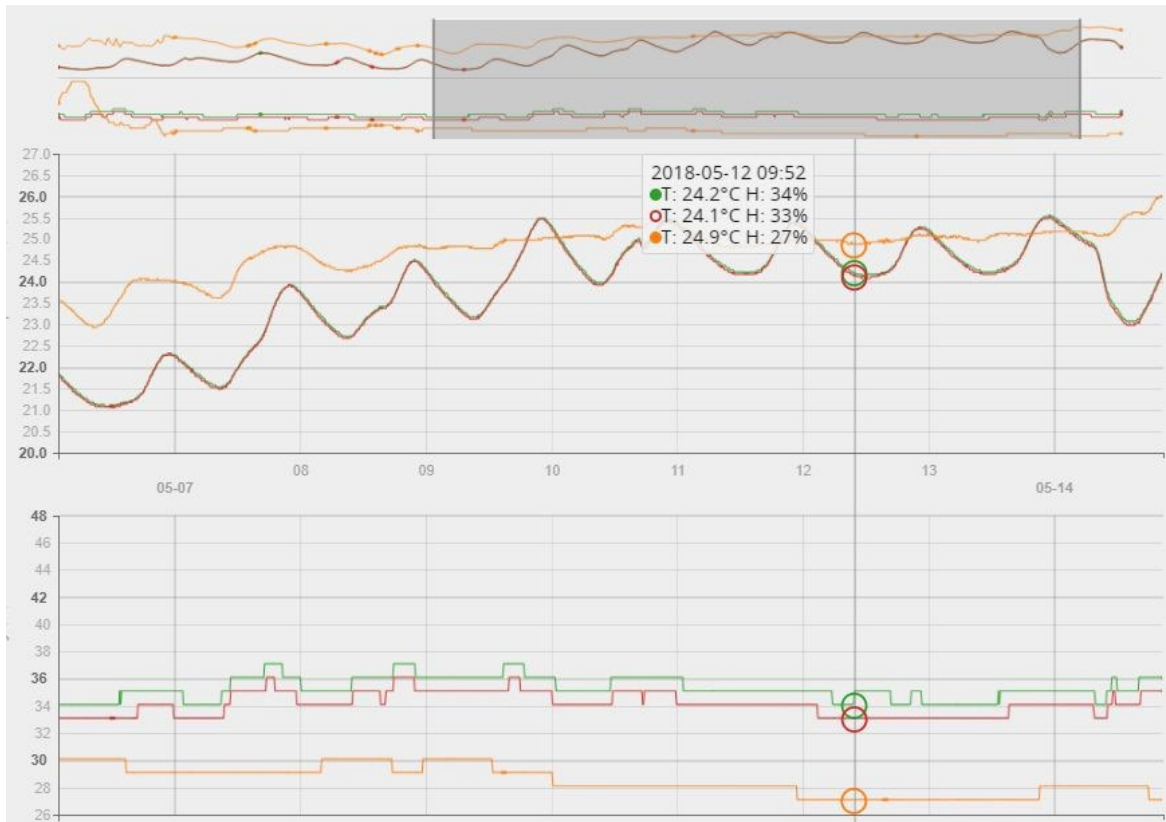

If you wish to highlight some sensor's data in the graph, click on the sensors name.

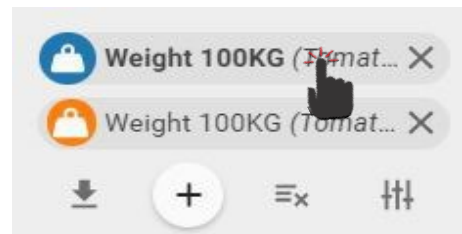

The graph line of the selected sensor will be highlighted in **bold**.

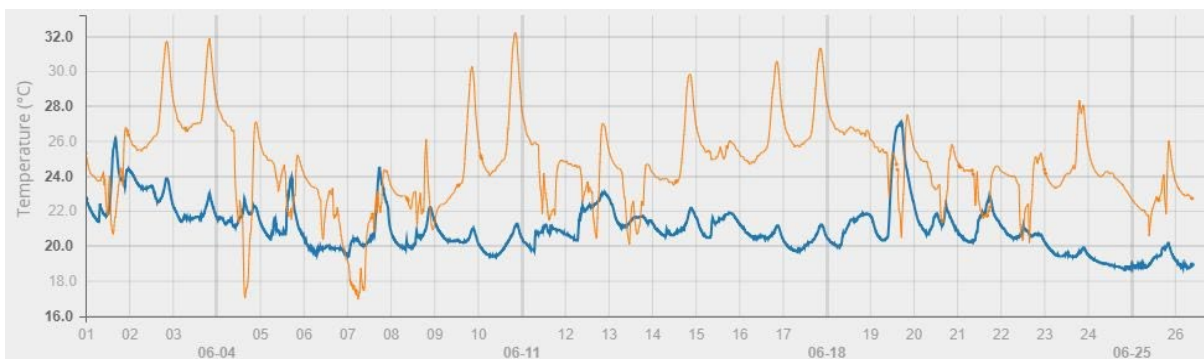



To display the measurement curves with more granularity, untick the **Autoscale** and choose the Min and Max values by moving the slide bars or typing in the required values.

To rearrange the order in which the graphs are displayed, drag the parameter boxes by the **Move**  handle. Release it in the desired position.

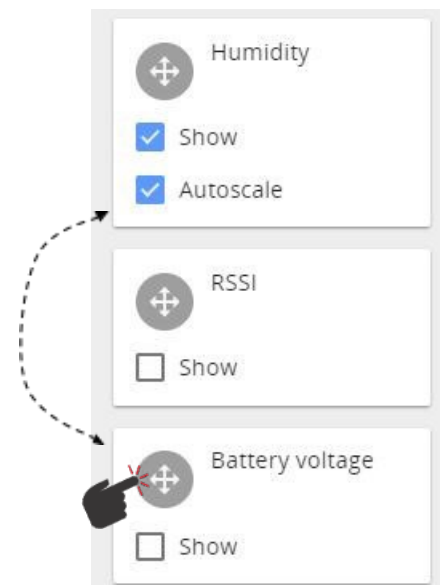

3.4 Sensors

Sensors settings is where sensors can be paired and the sensor information, such as group, name and thresholds, can be adjusted (see [2.2 Pair sensors to Aranet Pro](#) and [3.5 Groups](#) sections).

Some parameters are applicable only to specific sensors, see chapter [4 SENSORS' SPECIFIC NOTES](#).

3.5 Groups

Aranet SensorHUB allows users to create sensor **groups**, which can be helpful when managing large number of sensors. **Groups** can have names that represent for instance their type, location, room, etc. As well as set alert thresholds and choose different alarm types applicable for whole group. Maximum number of supported groups is 20.

3.5.1 Using groups

- (1) You should be logged in using an account with administrative rights.
- (2) To create a new group, go to Aranet PRO/PRO Plus Main menu and choose the **"Groups"** menu.

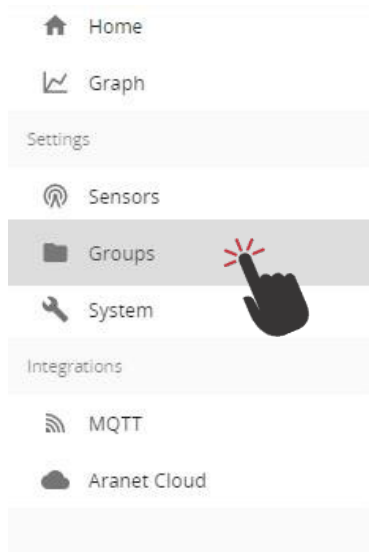

- (3) Click "Add group" .

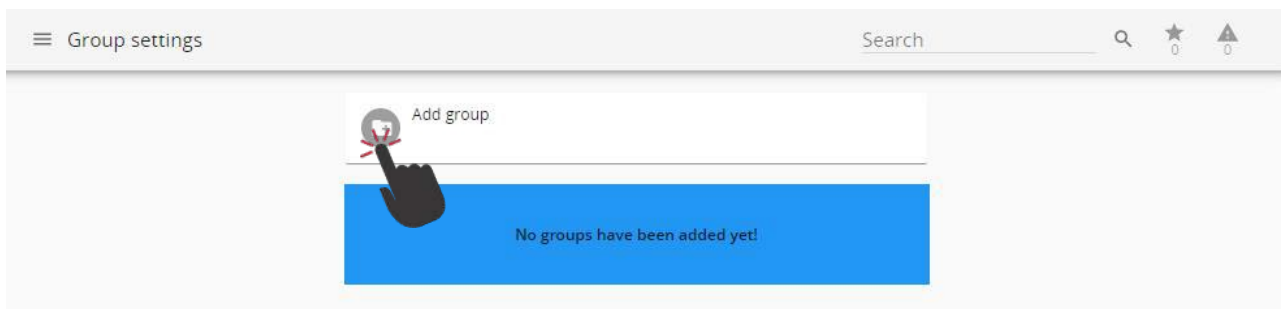

- (4) Now the group can be renamed and thresholds for alarms can be set. These thresholds work for all sensors in the group, unless a sensor is specified to use its own threshold in sensor menu. After editing click the **Save**  button.

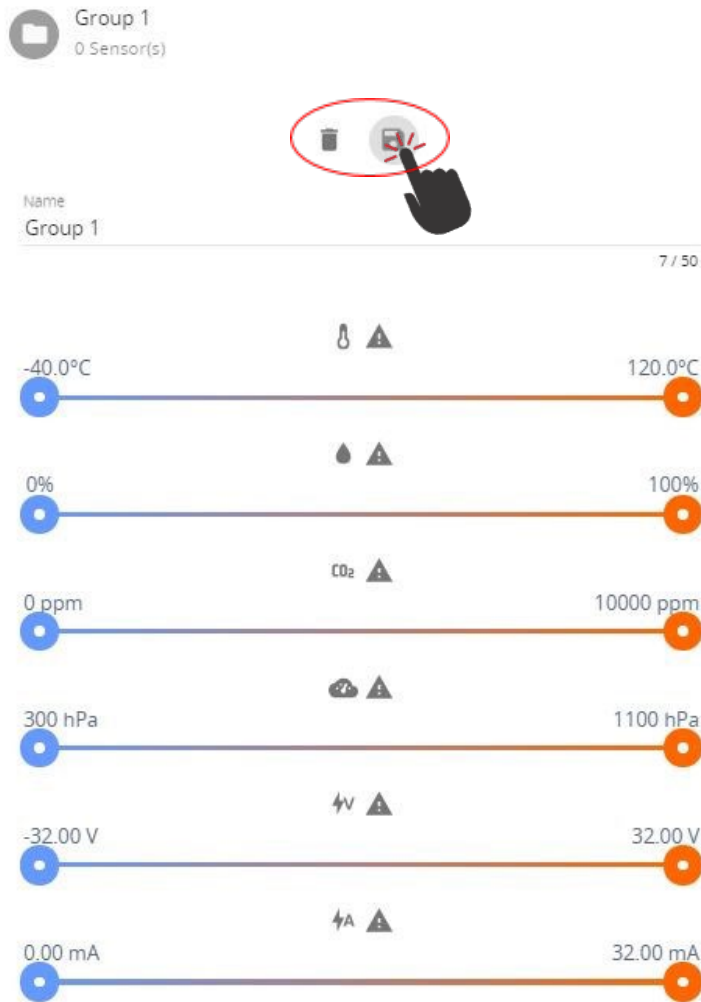

(5) To add sensors to a group, choose the “Sensors” menu and click on the item you would like to add. (Same is possible from main menu “Home”)



(6) In sensor options click on the group drop down menu. Choose the group you would like to add this sensor to.

(7) In sensor options it is also possible to toggle between sensor thresholds and group thresholds as preferred, so even grouped sensors can have individual thresholds.

(8) Click the **Save** button to save changes.

3.6 System

“System settings” screen is where you will find critical information and options for your Aranet PRO/PRO Plus.

3.6.1 Status menu

The **status** screen is a status information screen that will provide you with information about the Aranet PRO/PRO Plus.

You can change the name of the Aranet PRO/PRO Plus device by clicking on the **pencil**  sign and typing in the new name and confirming the change with the **SAVE** button.

Aranet PRO/PRO Plus device name will be used in the email notifications for easier identification of which Aranet PRO/PRO Plus device is sending the message.

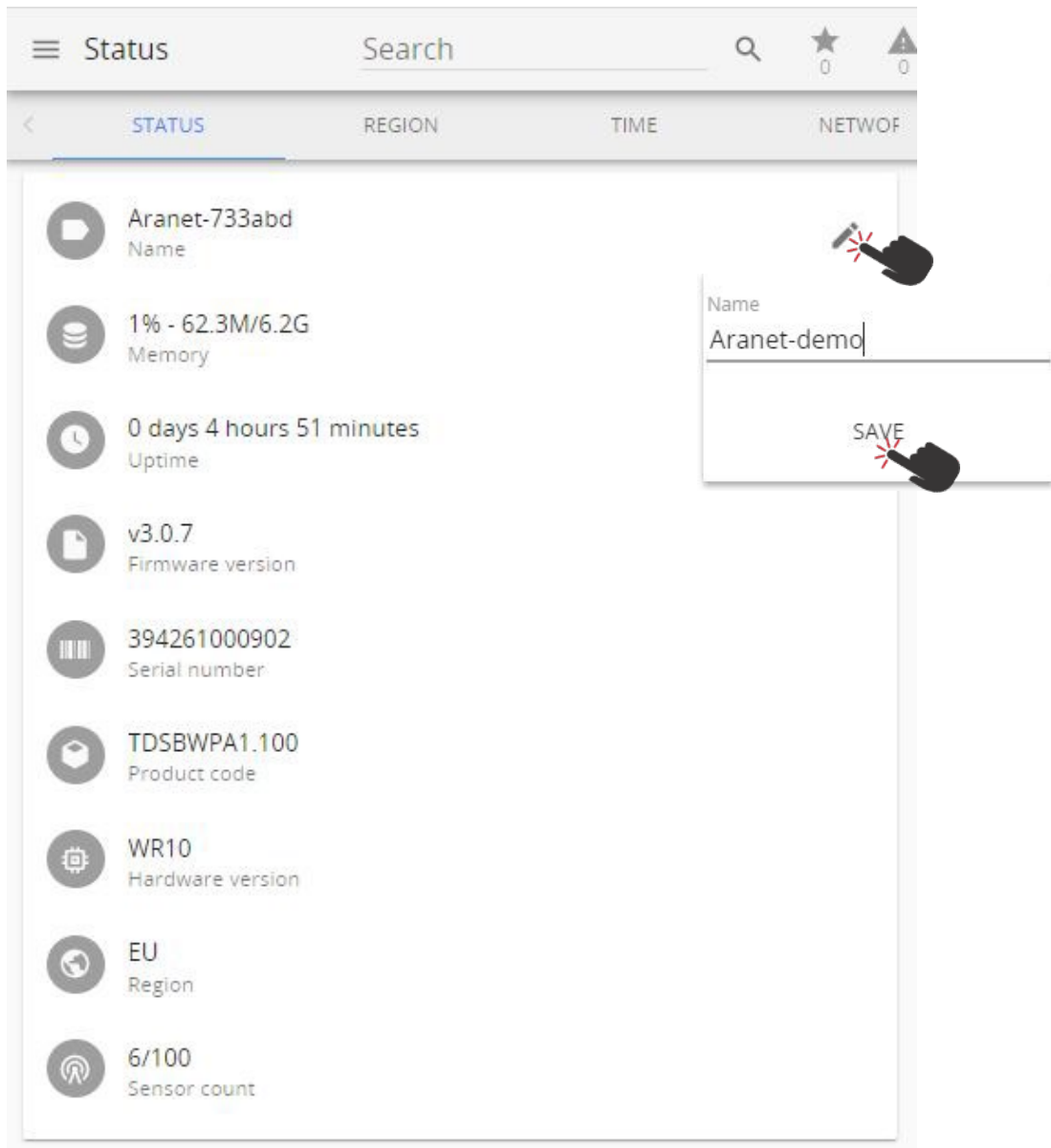

3.6.2 Region menu

The “**Regional settings**” menu is where the interface of Aranet PRO/PRO Plus can be set up with the preferred language, temperature scale and time and date format settings. To apply new settings, click **Save**  button.

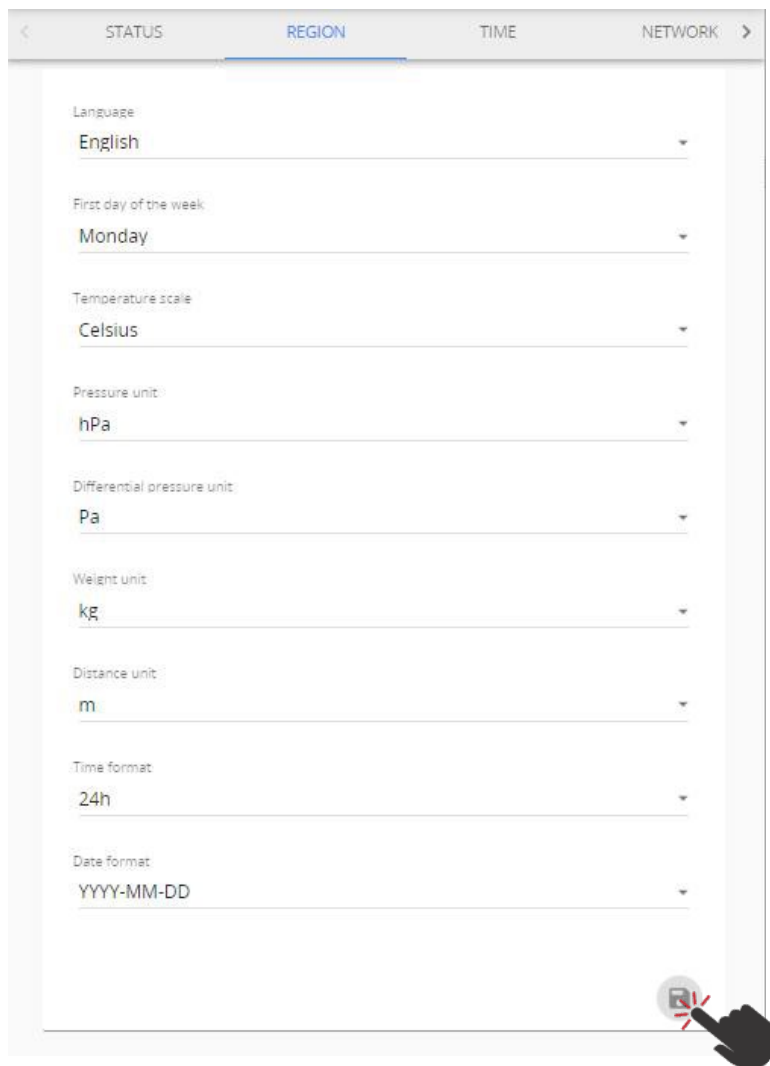

3.6.3 Time menu

By default, Aranet PRO/PRO Plus uses the local devices time settings, however it is possible to change the time and set it up manually, if it is preferred, as well as to use an NTP server for time synchronization.

NTP time synchronization requires connectivity with Internet (refer to chapter [3.6.4 Network menu](#)).

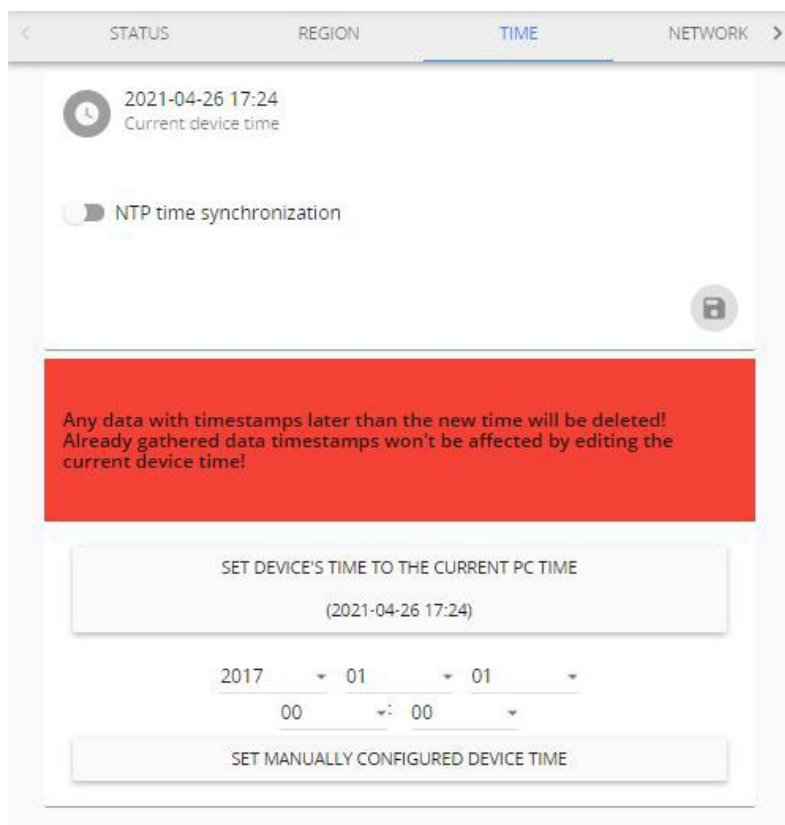

!NOTE! If device time is adjusted backwards, any data previously gathered with a timestamp later than the newly set time will be discarded and permanently lost.

It is recommended to enable NTP time synchronization if Aranet PRO/PRO Plus is registered to Aranet Cloud.

3.6.4 Network menu

The “**Network settings**” menu is where you can configure the connectivity of Aranet PRO/PRO Plus. Wi-Fi and Ethernet connectivity is supported for connecting to the internet; however, Ethernet connectivity is preferred for stability. It is also recommended to disable not used network interfaces to lower the processor load.



Aranet PRO Plus LTE P/N TDSBOB03, TDSBOBU3, TDSBOBC3 have built-in GSM LTE 4G modem accepting MINI size SIM-card. SIM-card as well as Mobile network connection plan are not included in the scope of delivery and should be purchased by the Aranet PRO Plus LTE base owner separately.

3.6.4.1 WIFI menu

By default, Aranet PRO/PRO Plus is configured as a **Wi-Fi Access Point** for easy initial configuration. However, if you wish this can be changed. The first menu screen is for the Wi-Fi setup where you can choose between **Access Point** and **Client** connectivity.

Factory settings of Aranet PRO/PRO Plus Wi-Fi interface are:

- Wi-Fi interface configured as Access Point
 - SSID - “Aranet-*****” (refer to the label attached to Aranet PRO/PRO Plus); Encryption – WPA2-PSK-CCMP;
 - **Aranet PRO Mk2** SSID - “Aranet-*****” Encryption – None;
 - IP address – 192.168.206.100;
 - Subnet Mask – 255.255.255.0



The image shows the Aranet label with the following information:
- Logo: aranet
- Barcode
- Text: PRO base station, Made in Latvia, EU, www.aranet.com, M/N: TDSBWB01, S/N: 349681000113
- Wi-Fi SSID: Aranet-5e63aa
- Wi-Fi IP: 192.168.206.100
- ETH IP: 192.168.205.100
- ETH MAC: C493000A2592
- Username: root
- Password: nMbgvcwxM3
- Power: 12V 0.5A
- CE mark and a crossed-out trash can icon.

- (1) In Access point connectivity it is possible to add/change password to your Aranet PRO/PRO Plus Wi-Fi, as well as change its name, IP address and subnet mask. Apply the changes by **Save**  button.

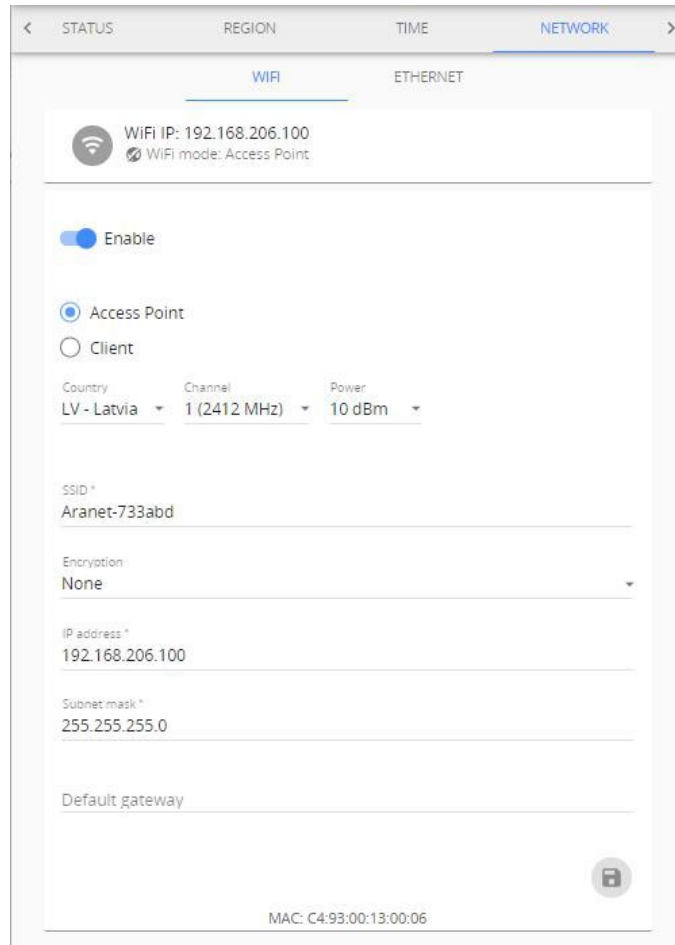

- (2) In case you wish to connect Aragnet PRO/PRO Plus to a local Wi-Fi network choose the **Client** mode, find the appropriate Wi-Fi connection, and fill in the Wi-Fi password. Apply the changes by **Save**  button.

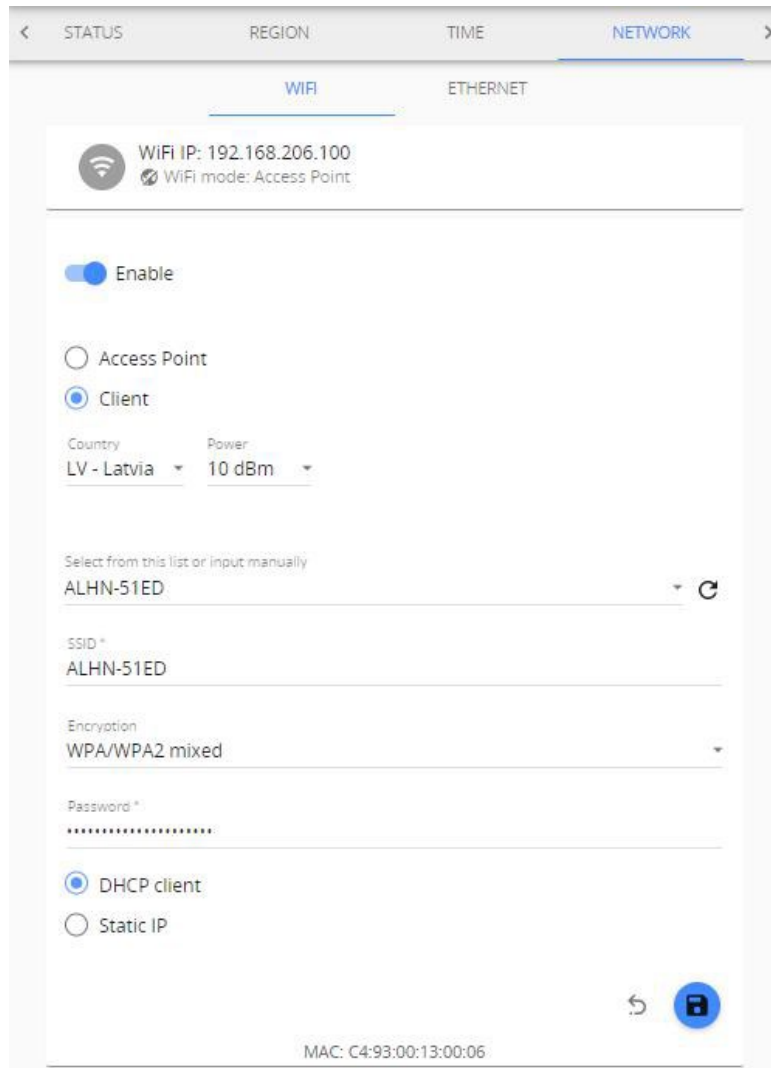

The screenshot displays the 'NETWORK' configuration page for the Aragnet PRO/PRO Plus router. The 'WIFI' tab is selected, showing the following settings:

- WiFi IP: 192.168.206.100
- WiFi mode: Access Point (checked)
- Enable:
- Mode: Access Point, Client
- Country: LV - Latvia
- Power: 10 dBm
- Select from this list or input manually: ALHN-51ED
- SSID: ALHN-51ED
- Encryption: WPA/WPA2 mixed
- Password: [Redacted]
- IP Mode: DHCP client, Static IP
- MAC: C4:93:00:13:00:06



!NOTE! Most routers have DHCP enabled by default, we recommend keeping this setting for ease of set up. For advanced users, however, static IP address set up is possible.

Globe  symbol with no crossover indicates successful connectivity to network.

3.6.4.2 Ethernet menu

Ethernet connection is preferred for Aranet PRO/PRO Plus, as it is generally more reliable. In the **Ethernet** menu there are two options - either to have it work in **DHCP** client mode or have a **Static IP**.

Factory settings of Aranet PRO/PRO Plus Ethernet interface are:

- DHCP client – On;
- Static IP fallback – On;
- IP address – 192.168.205.100;
- Subnet Mask – 255.255.255.0.

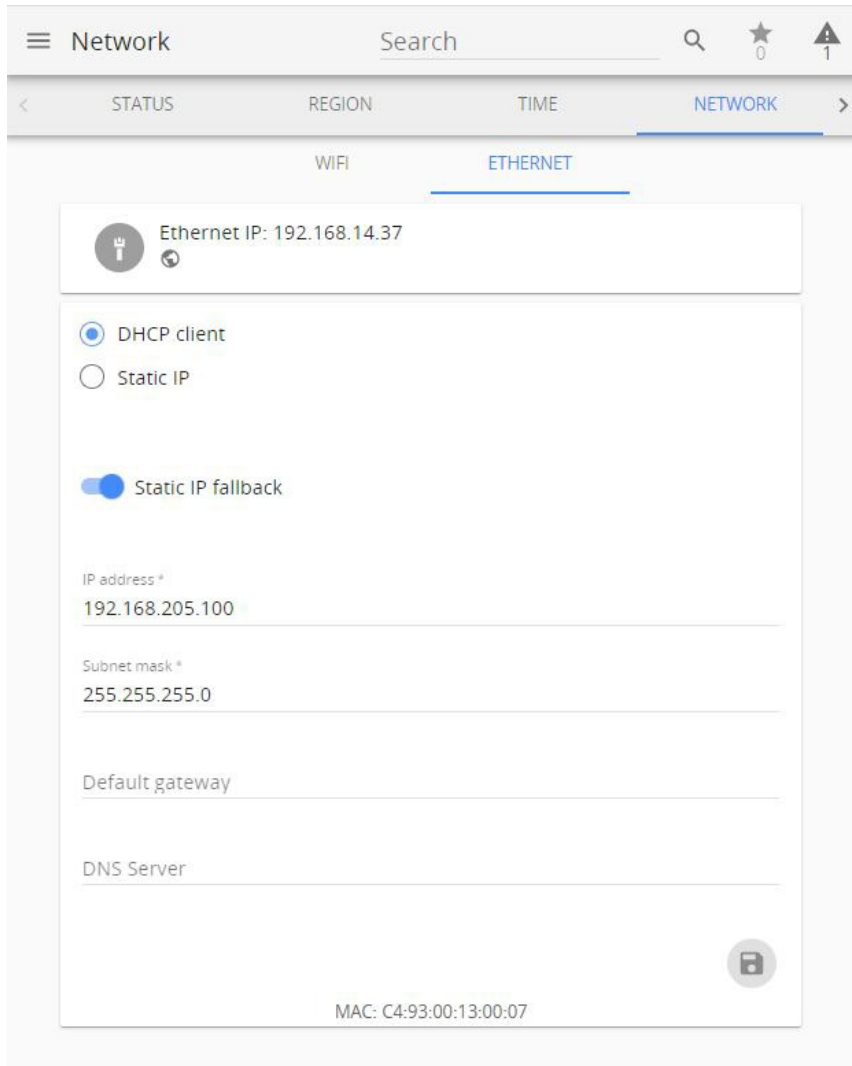

Static IP fallback switch is visible when DHCP client mode is selected. When switched *ON*, and Aranet PRO/PRO Plus *did not receive IP address* from DHCP server, last settings entered in *IP address*, *Subnet mask*, *Default gateway* and *DNS server* fields are applied. If no settings were entered before, default Factory settings are in force. The same settings are in force after [NETWORK RESET](#).

If **Static IP fallback** is switched *OFF*, no valid IP address is assigned to Aranet PRO/PRO Plus Ethernet interface when it *did not receive IP address* from DHCP server.



!NOTE! Most routers have DHCP enabled by default, we recommend keeping this setting for ease of set up. For more advanced users, however, static IP address set up is possible.

Globe symbol with no crossover  indicates successful connectivity to network.

3.6.4.3 LTE menu



Aranet PRO Plus LTE P/N TDSBOB03, TDSBOBU3, TDSBOBC3: LTE menu is visible when modem is detected by the system. Mini size GSM SIM-card with valid Mobile Internet contract must be inserted into the modem to ensure its functionality. SIM-card is not included in the Aranet PRO Plus LTE scope of delivery. It is customer's duty to sign the contract for Mobile Internet connection usage. Using Mobile Internet can cause additional expenses not covered by Aranet PRO Plus LTE manufacturer.

Please consult your Mobile Internet provider for data to fill out connection configuration fields.

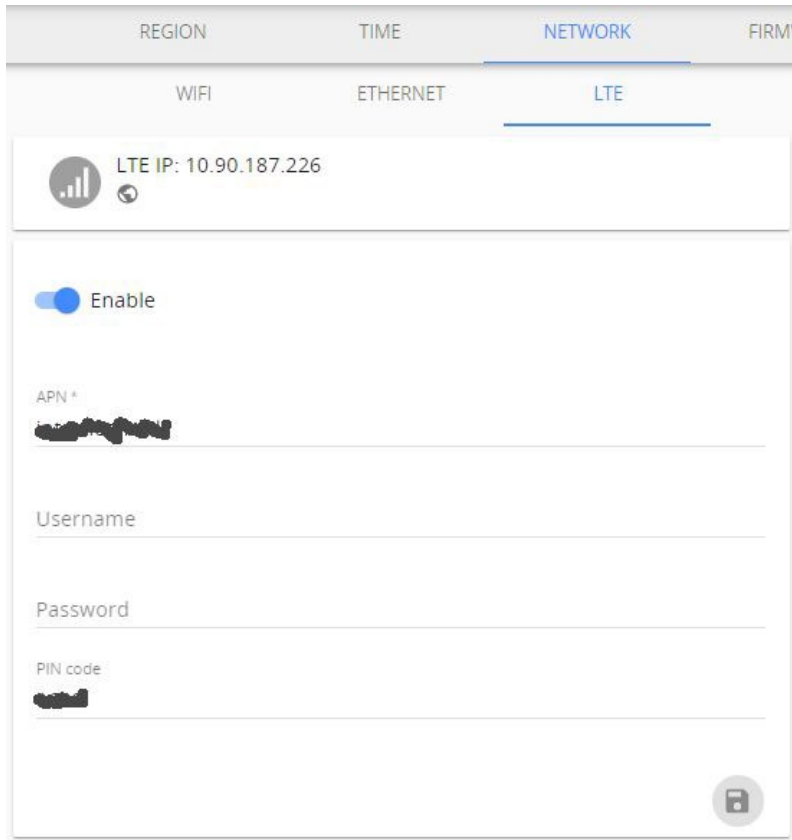

It is possible to access Aranet PRO Plus LTE web interface from internet over LTE connection. For this purpose, please contact your Mobile Internet provider and request *static* IP-address for the SIM-card inserted into modem.



!NOTE! LTE connection configuration with *static* IP-address may differ from one with dynamically assigned IP-address. Please consult your Mobile Internet provider for details.

Globe  symbol with no crossover indicates successful connection to network.

3.6.5 Firmware menu

The **firmware** submenu shows current software version and allows to update it. Semi-automatic update is implemented since Aranet PRO/PRO Plus firmware v. 3.0.1.; manual update is possible too. For semi-automatic firmware update Aranet PRO/PRO Plus must be connected to internet.

When navigating to this menu, Aranet PRO/PRO Plus connects to *SAF Tehnika* server over HTTPS protocol TCP on port 443 to check for newer firmware version availability. If newer firmware version is released, notification is shown.

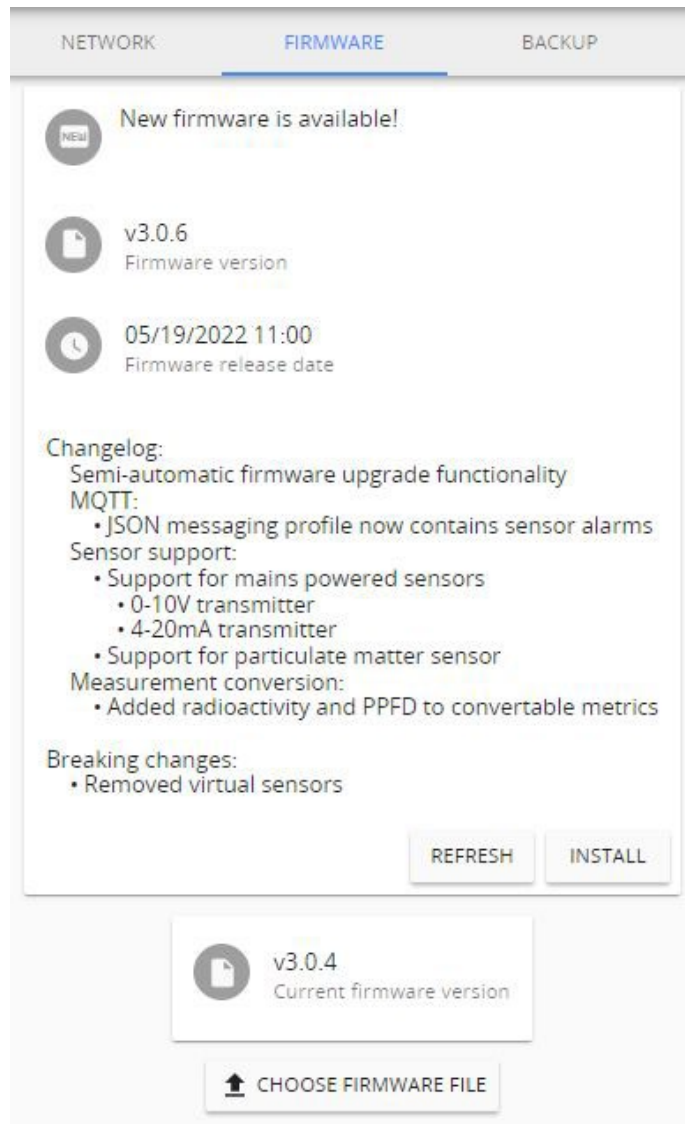

If the base is not connected to internet, the error message is displayed:

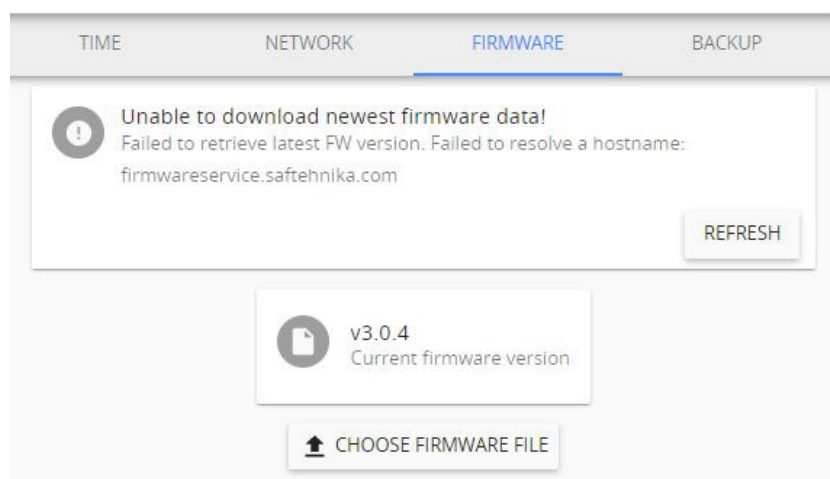

To update firmware, press **INSTALL** button. After confirming the update with Administrator password, process will start.

Following message is displayed when process is finished:



To update firmware manually, first download the firmware update file from aranet.com/downloads/ and store it on your PC. Extract file with extension **.gz** from the archive. Do not unpack the firmware file! Then click on the **“CHOOSE FIRMWARE FILE”** text box and locate the **.gz** file on the PC. Once that is done press the upload button next to it.

!NOTE! Firmware can be upgraded to the same or higher version only. Downgrade is possible to the subversion only. I.e. downgrade from v.3.x.x **is not** possible to v.2.x.x or 3.y.y; downgrade **is** possible from v.3.x.x to v.3.x.y. Firmware upgrade file name should not be changed, as it might not be recognized otherwise.



The software update usually takes about two minutes to be completed. During that period, the device will reboot to complete the update. After the firmware upgrade, if the Aranet PRO/PRO Plus web interface does not function properly, we recommend clearing the browser's cache.

Example on clearing the cache for Chrome web browser:

- (1) On your computer, open Chrome.
- (2) At the top right, click **More** 
- (3) Click **More tools > Clear browsing data**.
- (4) At the top, choose a time range. To delete everything, select **All time**.
- (5) Next to **"Cookies and other site data"** and **"Cached images and files,"** check the boxes. (6) Click **Clear data**.

3.6.6 Backup menu

The **backup** menu is where user can create a backup for device settings.

When Aranet PRO/PRO Plus base is registered to Aranet Cloud (see [p. 3.7.2 of this document](#)) it sends a backup file to the Aranet Cloud once per day when any changes in the base configuration or sensors list are made. Up to 10 latest backup files are visible to the Aranet Cloud user and can be downloaded from base information card in Aranet Cloud.

- (1) To perform a backup just click the “**EXPORT BACKUP**” button and a file will automatically be downloaded. It enables quick cloning of settings and sensors of current Aranet PRO/PRO Plus for either duplication reasons, or if full factory reset is necessary, which also can be performed in this menu.
- (2) To upload a backup file, click on “**IMPORT BACKUP**” and locate a backup file. Once that is done click the upload icon next to it. You will be asked for administrator’s password: type it in and click “**OK**”.
- (3) To upload backup file to Aranet Cloud manually, click on “**UPLOAD BACKUP**”.

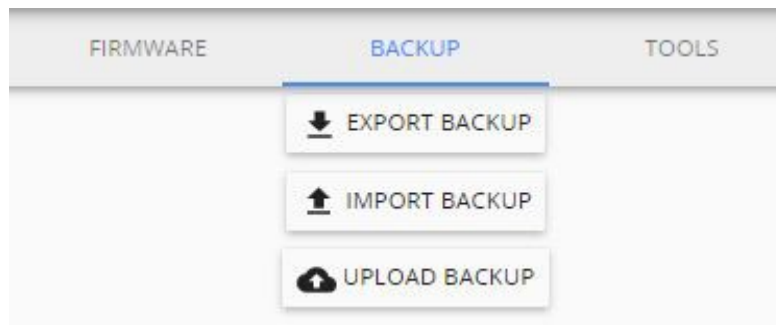

!NOTE! It is important to remember that the gathered data will not be saved in the backup file, it needs to be exported in case you wish to save it.

Aranet PRO/PRO Plus **Name** and **Network settings** is saved in the backup file; if you duplicate (clone) the base station, current Aranet PRO/PRO Plus name and Network configuration will be overwritten with imported one!

3.6.7 Tools menu

Aranet PRO/PRO Plus base management options, such as **remote reboot**, **network reset**, **full factory reset**, and **diagnostics** file download are available here:

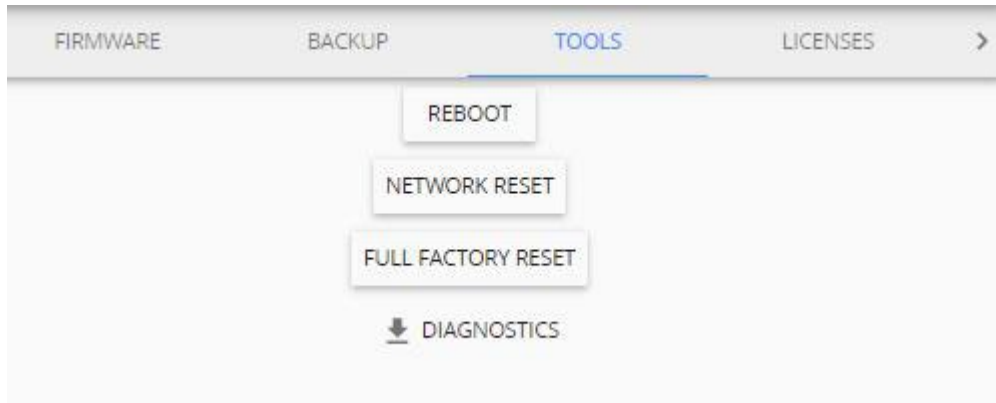

REBOOT – reboots the Aranet PRO/PRO Plus.

NETWORK RESET will load the default network settings for Aranet PRO/PRO Plus and can also be performed by a **network reset button** on Aranet PRO/PRO Plus by holding it for 5 or more seconds, however that will also reset the root user password.

FULL FACTORY RESET will delete all the configuration data and reset Aranet PRO/PRO Plus to default settings. Previously recorded measurement data will be available and not be deleted.

DIAGNOSTICS – file containing specific Aranet PRO/PRO Plus base station information is downloaded by clicking this button. This file could be helpful for malfunctioning investigation and ought to be sent to factory for analysis.

3.6.8 Licenses menu

List of purchased and installed Aranet PRO/PRO Plus licenses is available here.

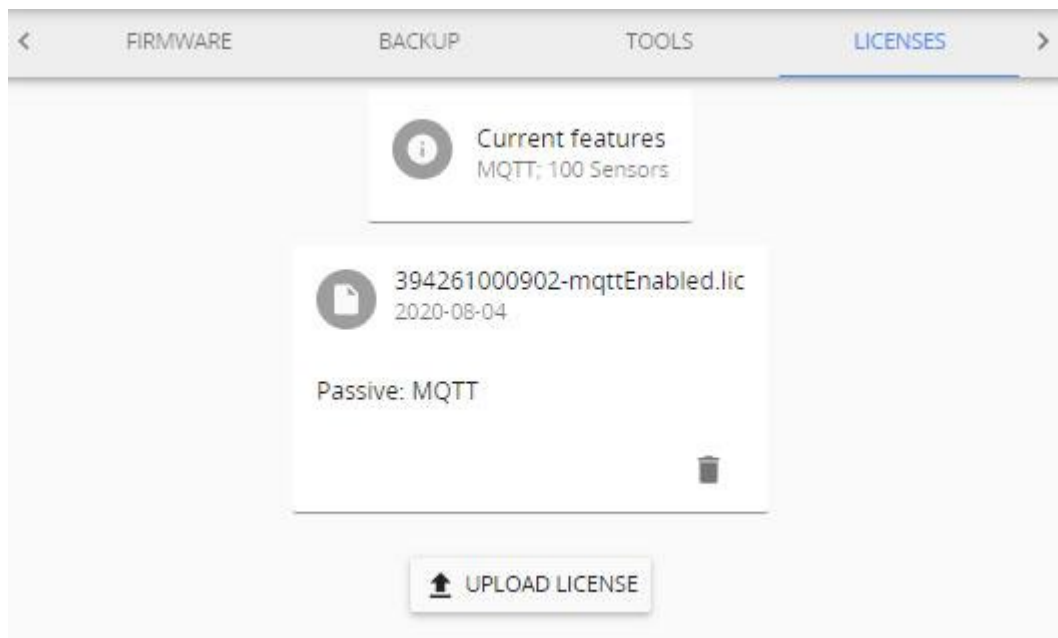

To add new license to Aranet PRO/PRO Plus base station click **UPLOAD LICENSE** button, select license file, and click **OK**.

3.6.9 Notifications

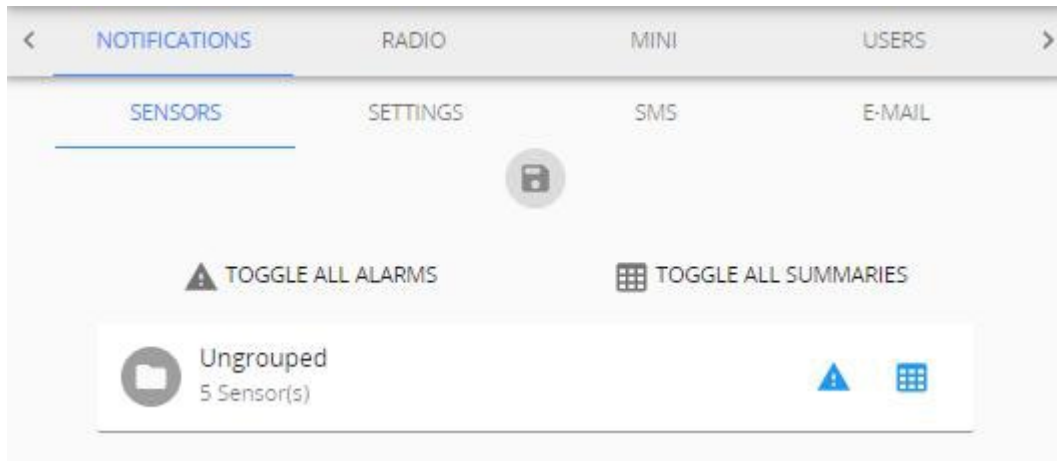

“Notifications” menu offers management of alarms and summaries. Aranet PRO/PRO Plus offers receiving alarms and summaries via e-mail notifications or text messages (SMS).

Notification settings are applicable for each individual user account. Each user account can have different notification settings like summary, alarms, e-mail, and phone number for SMS delivery.



3.6.9.1 Sensors screen

The first **Sensors** screen shows groups of sensors and allows you to choose individual settings for each group.

- (1) Click icons to receive **alarms**  for thresholds crossed, **summaries**  or both.
- (2) If sensors are not added to any group, they will be automatically grouped together under “Ungrouped”.
- (3) If you click on the group, it will expand to show individual sensors in case you wish to individually manage which sensors you will be notified about.
- (4) Click on **Save**  button.

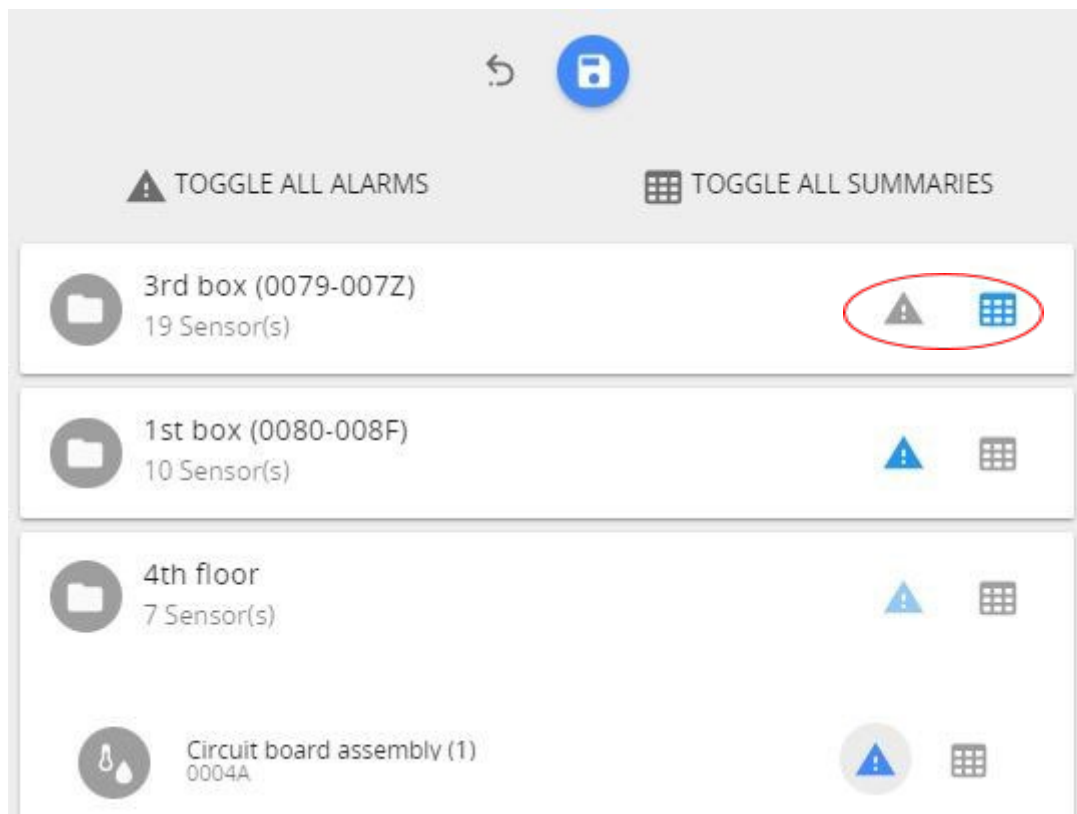

An e-mail and/or SMS will be sent immediately or after the delay time set under “**Notification delay**” for the respective sensor. For setting a Notification delay navigate to the **Main menu (Home)** and click on required sensor.

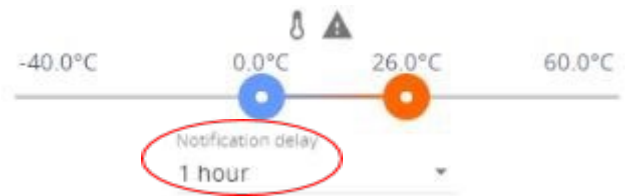

3.6.9.2 Settings screen

The **Settings** screen is where you can choose if you want to receive notifications via email, text messages or both, and what type of notification to receive.



!NOTE! To set up an *e-mail notification*, please start with configuring the [E-MAIL](#) which notifications will be sent from. Then proceed back to **SETTINGS** to specify email address where notifications will be sent to.

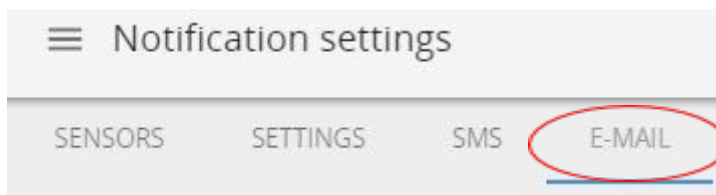

- (1) Input your email address and phone number to receive the notifications.
- (2) **Save** changes once you have completed all tasks.
- (3) It is suggested to perform a test of notifications by using the **TEST SENDING** button located at the bottom of Settings screen. If correct email and/or phone number is entered, the notification message should be delivered. Allow some time for notifications being delivered. Check any spam folder in case of missing test email notification.

SENSORS

SETTINGS

SMS

E-MAIL

E-mail

 Enable

E-mail*

test@somesite.com

Summary sending condition

Always send

Summary send time

15:00

 Send system warnings Send sensor alarms Send "sensor returned to normal" alerts

SMS

SMS settings have to be configured, before SMSs can be sent!

 Enable Send system warnings Send sensor alarms Send "sensor returned to normal" alerts

Alarms

Packet loss alarm

After 3 missing in a row

Save configuration to enable test sending.

TEST SENDING



Send system warnings – enables the notifications related to Aranet PRO/PRO Plus system events (like reboot, shutdown, upgrade, main power failure, etc.)

Send sensor alarm – enables notifications related to sensor alarms (like threshold crossed, battery low or battery empty)

Send “sensor returned to normal” alerts – enables notification related to sensor when its state has returned to normal (for instance, measurement returned below threshold).

Alarms – set communication alarm creation rule: how many sensor’s measurements in a row are lost before communication alarm is generated.

To send an e-mail and/or SMS notification to several recipients, please create additional user accounts and configure their respective e-mail address and phone number.

3.6.9.2.1 Summary report

Summary report, if enabled and configured, will be sent once per day at a time (HH:00) specified by setting “summary send time”.

The report will be sent in an email containing the following information:

- Minimum, average and maximum of Temperature, Humidity, CO2, Pressure, Voltage, Current.
- Packet loss in percentage (with missing packet count and the maximum number of packets lost in a row).
- Temperature, Humidity, CO₂, Pressure, Voltage and Current alarms when a threshold was crossed (above or below) and its duration.
- Name of the sensor and name of group it belongs to.
- Battery warnings.
- Channel warnings (in case a sensor is using a different radio channel than the Aranet PRO base station).
- Warnings about number of faulty data packets received.
- Sensor restart warnings including the number of restarts.
- Sensor error warnings.
- System information such as: how many days, hours, minutes the system has been running, number of device reboots, number and duration of main power loss, number of factory and network resets, current Firmware version and memory usage in %.

(1) summary information in the e-mail, like shown in the example below.

Temperature			Humidity			CO2			Pressure			Voltage			Current			Packet loss	Name	Group
Min	Avg	Max	Min	Avg	Max	Min	Avg	Max	Min	Avg	Max	Min	Avg	Max	Min	Avg	Max			
21.2°C	24.4°C	25.7°C	28%	30%	34%	-	-	-	-	-	-	-	-	-	-	-	-	0%	Sens 1	Group 1
-	-	-	-	-	-	-	-	-	-	-	-	-	-	-	0.00 mA	0.00 mA	0.00 mA	1%	Sens 3	Group 2
• Humidity: 1 alarm (under), duration 24h 0min (under) • 1 packets missing (max 1 in a row)!																				

System information:

Running for 24 h 00 min
 Device rebooted 0 times
 Power lost 0 times (0 h 0 min)
 Number of factory resets: 0
 Number of network resets: 0
 Firmware version: v1.4
 Memory usage: 1% (40.7M/6.2G)

(2) Excel summary file as attachment to the notification e-mail, containing the above stated information like shown in the example below.

Temperature			Humidity			CO2			Pressure			Voltage			Current			Packet loss	Name	Group
Min	Avg	Max	Min	Avg	Max	Min	Avg	Max	Min	Avg	Max	Min	Avg	Max	Min	Avg	Max			
21.2°C	24.4°C	25.7°C	28%	30%	34%										0.00 mA	0.00 mA	0.00 mA	0%	Sens 1	Group 1
																		1%	Sens 3	Group 2

Temperature alarms			Humidity alarms			CO2 alarms			Pressure alarms			Voltage alarms			Current alarms			
Over	Duration	Under	Over	Duration	Under	Over	Duration	Under	Over	Duration	Under	Over	Duration	Under	Over	Duration	Under	
					1	24:00:00												

Warnings			
RSSI	Battery Channel	Faulty/misordered data packets	Sensor restart
1 packets missing (max 1 in a row)!			

3.6.9.3 SMS screen

The **SMS** screen is where you can set up SMS alarm functionality.



Aranet PRO Plus TDSBOB03, TDSBOBU3, TDSBOBC3: SMS functionality can be enabled if SIM-card with valid Mobile Internet contract is inserted in Aranet PRO Plus LTE modem. Refer to [p.3.6.4.3 LTE menu](#) of this document for configuration.

Aranet PRO: SMS functionality is enabled if you have a USB GSM modem with an active SIM card connected to Aranet PRO. Please find actual information about the supported (tested) GSM modems here:

<https://forum.aranet.com/aranet-solutions/what-cellular-usb-modems-are-compatible-with-aranet-pro-base-station/>

Please note that other modems not listed here might be used as well. To determine if your modem function properly, user can perform a simple test using **“TEST SENDING”** button described in previous chapter.

In some cases, modem requires PIN entered even PIN security is disabled on the SIM card. When inserting modem for first time, allow up to 3 minutes for modem to stabilize. Status “OK” indicates that modem is ready. During initializing the status might change several times. Following messages will indicate status of modem:

GSM modem not connected – GSM modem is not connected or is not recognized. Re-insert the modem and allow it to stabilize.

Modem did not accept this PIN – indicates that entered PIN code is incorrect. Enter correct PIN code.

Fault description – indicated additional information about the fault modem is experiencing. Ok – modem is ready.

Using button **RETRY** can help modem to initialize again in case of fault situation.

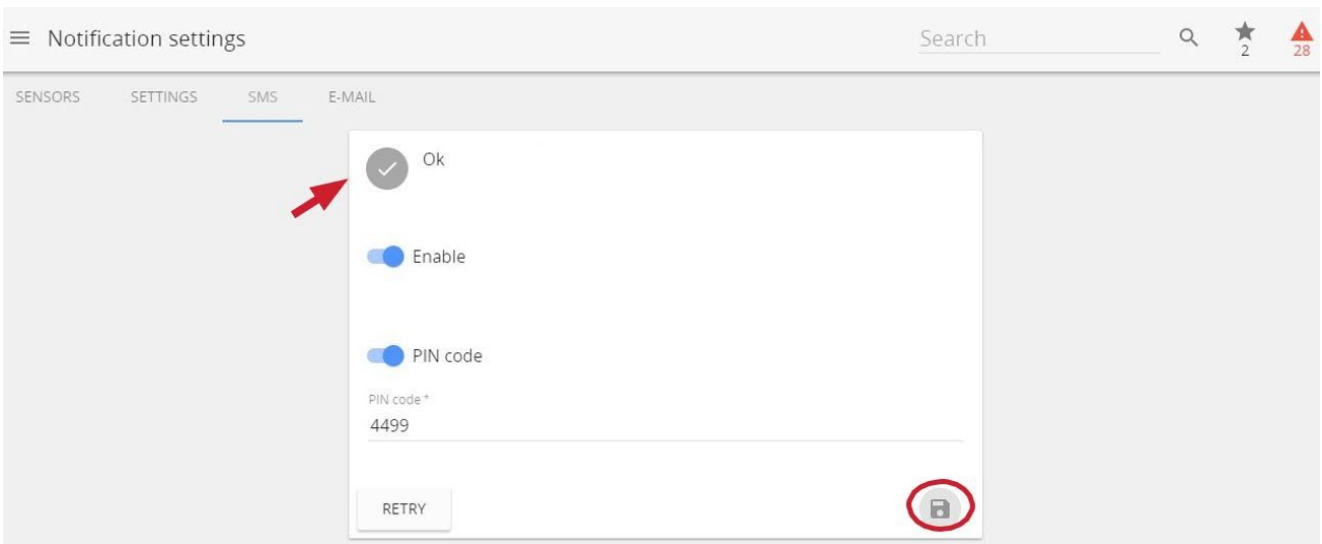



!NOTE! The SIM card cannot be activated through Aranet PRO/PRO Plus software, the card can only be unlocked with the PIN code, so it must be pre-activated.



Aranet PRO: Keep in mind maximal current of 500mA the base can supply over USB-connection. In case of current draw exceeding 500mA (i.e., due to low cellular reception levels) the base station may be unable to supply sufficient current to the modem thus causing unstable behavior. This can be remedied using an external power supply and “Y-type” USB cable with DATA+POWER and POWER jacks to supplement the power. Make sure to connect the cable correctly!





3.6.9.4 E-mail screen

The **e-mail** screen is where you set up the e-mail from which the notifications will be sent.

There is support for *Gmail*, *Outlook*, and *Yahoo* accounts, however a Custom SMTP provider can also be set up.

For e-mail notifications to work, the Aranet PRO should have connectivity to mail server (internet or other data network). Please refer to chapter [3.6.4 Network](#) for details.

Successful connectivity is indicated by the globe symbol that is not crossed over. Indication examples:

-   - indicates proper connectivity to internet via Ethernet cable
-   - indicates no connectivity to Wi-Fi and no connectivity to internet via Wi-Fi

Some email service providers like **Gmail** requires enabled “2-step verification”.

Using Customer SMTP as E-mail service provider, consult with the provider for appropriate SMTP settings to use.

It is advised to check whether notification e-mails do not end up in spam folder.

Other typical messages about connectivity:

E-mail server reached successfully! – connectivity with SMTP server is ok.

Connect error – no connectivity with SMTP server. Check the internet connection or consult the email service provider for further assistance.

AUTH error – incorrect **username** or **password**. For some e-mail service providers, you might need to enable “allow apps that use less secure sign in”.

Once all the required information is filled out, saved and the connection is tested successfully you can start receiving E-Mail alarms and summaries.

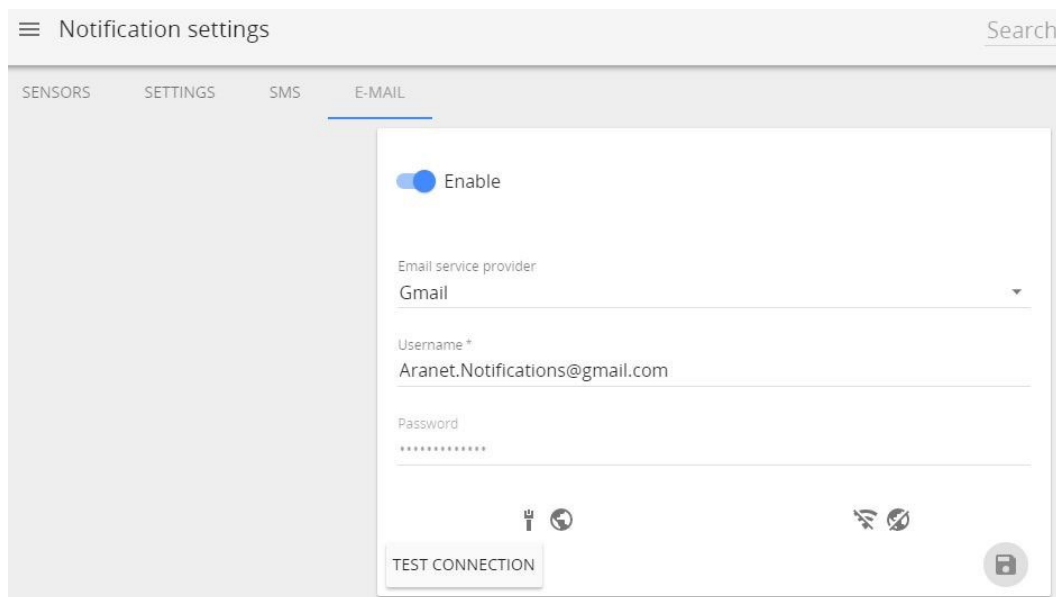

3.6.10 Radio menu

Radio menu allows to perform a channel radio availability scan for each of the available channels.

If the area has a dense coverage of sensors from other base stations this can become important.



!NOTE! If sensors are already paired to Aranet PRO/PRO Plus they will also show up as interference in the radio scan of the channel currently in use.

A channel scan can be activated for selected channel or all channels at same time. Scan takes 60 minutes per channel during which it is not possible to pair new sensors to the base station or change the time of device. Channel switching is disabled during the scan. Some data may be lost during the scanning period.

You can abort the scan process by selecting **STOP SCAN**. The statistics of scanned channel in this case will be lost.

After scan we recommend choosing the channel with the highest availability to ensure that you receive reliable data stream from the sensors and avoid data loss.



!NOTE! When changing channel, already paired sensors require re-pairing.

< RADIO MINI USERS SNMP >

Radio channel scan lasts 1 hour per channel. Some data may be lost during the scanning period. After scanning is completed, you can view the results in this section. During the channel scan, sensor pairing will be disabled.

SCAN RADIO CHANNEL(S) AVAILABILITY

Click on channel to switch to it:

- Channel 1E
Availability: -%
Scan start time: -
- Channel 2E
Availability: -%
Scan start time: -
- Channel 3E
Availability: -%
Scan start time: -

3.6.11 Aranet MINI monitor mode

Aranet MINI monitor mode serves as a screen function displaying up to 12 sensor data. It can be used if constant display of the data readings is required from the sensors paired to Aranet PRO/PRO Plus. User can set as many Aranet MINI to **Monitor** mode, as necessary.

Aranet MINI only supports *Aranet T/RH sensor, Aranet PT100 sensor and Transmitter, Aranet T Probe sensor and Aranet CO2 sensor.*



!NOTE! Configuring the Aranet MINI into monitor mode, previous configuration of the Aranet MINI will be overwritten. Follow the instructions below on how Aranet MINI can be reconfigured to its default standalone mode.

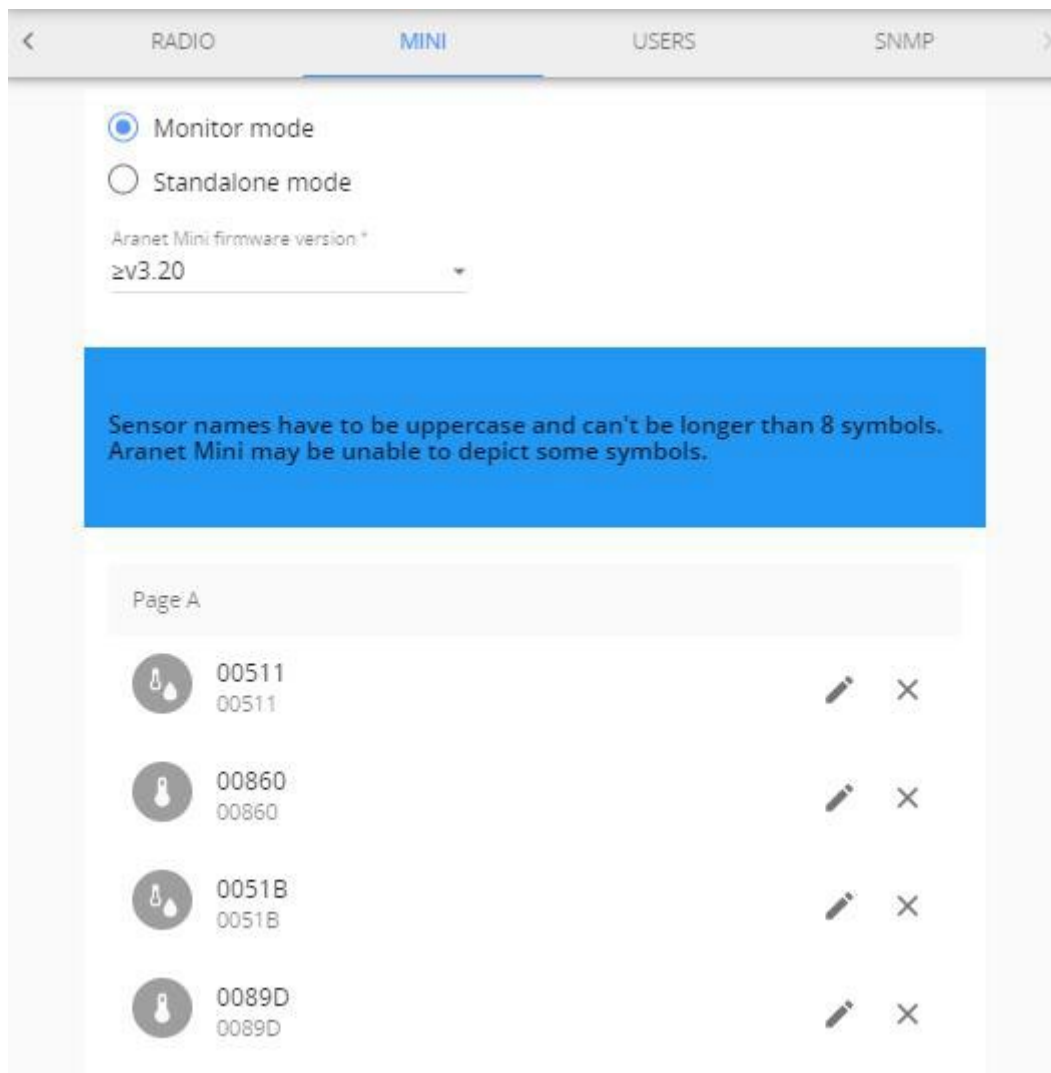

There are two ways to configure Aranet MINI to work in **monitor** mode:

3.6.11.1 Using a computer

- (1) To configure Aranet MINI into **monitor** mode you need to log in Aranet PRO using a desktop PC and choose the **Monitor** mode in **System** settings menu, submenu Aranet Mini.
- (2) Select the firmware version of Aranet MINI you will be using as Monitor.
- (3) Choose the sensors you wish to display on Aranet MINI (up to 12 sensors) by selecting the (+) buttons. Here you can change name of the sensors and rearrange the position by drag and drop.

- (4) Press the “**Download Configuration**” button. Configuration file is then saved on your computer and needs to be transferred on Aranet Mini to enable the monitor functionality.
- (5) Aranet Mini should be connected to a free USB port on the computer using for instance the included USB cable. It will automatically recognize Aranet Mini as a storage device. The downloaded file needs to be transferred to the Aranet Mini main file directory. New settings from configuration file will automatically be applied to Aranet MINI.

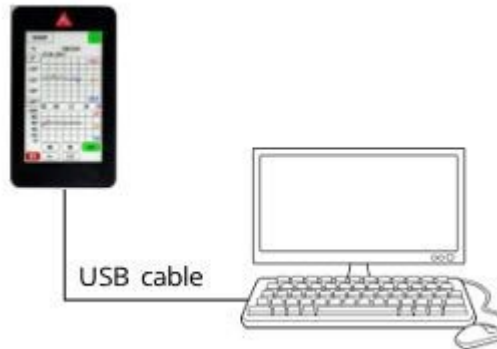

- (6) Disconnect the USB cable.
- (7) To return full Aranet MINI functionality select the Standalone mode in the same Aranet PRO menu and repeat steps 3 - 5.

3.6.11.2 Directly from Aranet PRO/PRO Plus to Aranet MINI

- (1) To configure Aranet MINI into monitor mode you need to log in Aranet PRO/PRO Plus using a desktop PC or a smart device and choose the Monitor mode in System settings menu, submenu Aranet Mini.
- (2) The firmware version of the Aranet MINI will be detected automatically once it is connected to Aranet PRO/PRO Plus. You do not need to select the version manually.
- (3) Choose the sensors you wish to display on Aranet MINI (up to 12 sensors) by selecting the (+) buttons. Here you can change name of the sensors and rearrange the position by drag and drop.
- (4) Aranet Mini should be connected to the USB port on the Aranet PRO/PRO Plus using the included USB cable. The “Upload via USB” button will become available, by pressing on it the settings will automatically be loaded on Aranet Mini.



- (5) Disconnect the USB cable.
- (6) To return full Aranet MINI functionality select the **Standalone** mode in the same Aranet PRO/PRO Plus menu and repeat steps 3 - 5.

3.6.12 Users menu

The **Users** is where you can create new users, delete, and edit the data about existing ones. There are two types of account groups - **User** and **Administrator**.

The **User** group account has limited access to many of the settings' features, however full access to data and sensors is granted. By default, user *Guest* in User group is provided.

The **Administrator** group account should only be given to those who need features, such as software update, network reset, threshold settings, etc. By default, **root** account in Administrator group is provided. Root account cannot be deleted, nor its name changed. **Root** account can modify other user accounts belonging to Administrator and User groups.

Up to 20 accounts can be created (including root).



!NOTE! Change the root user password! Default password is a placeholder that is well known and should only be used for initial setup or after resetting to factory defaults.

Refer to chapter [3.6.7 Tools, Factory reset](#) on options resetting root password.

< RADIO MINI **USERS** SNMP >

+ Add user

guest
User

🗑️ 🔒

Name *
guest 5 / 32

Group
User ▾

New password 0 / 32

Repeat new password 0 / 32

root
Administrator

3.6.13 SNMP menu

SNMP menu is where you setup Simple Network Management Protocol parameters for Aranet PRO/PRO Plus health monitoring. Necessary enterprise specific (*SAF-ENTERPRISE.MIB*, *SAF-ARANET-PRO.MIB*) and additional trap event type and severity level definitions related (*ITU-ALARM-TC.MIB*, *IANA-ITU-ALARM-TC.MIB*) MIB files can be downloaded here.

Current Aranet PRO/PRO Plus SNMP agent implementation supports read-only mode on OID request processing. Max 5 SNMP managers' IP v4 addresses and max 5 trap managers' IP v4 addresses can be added.

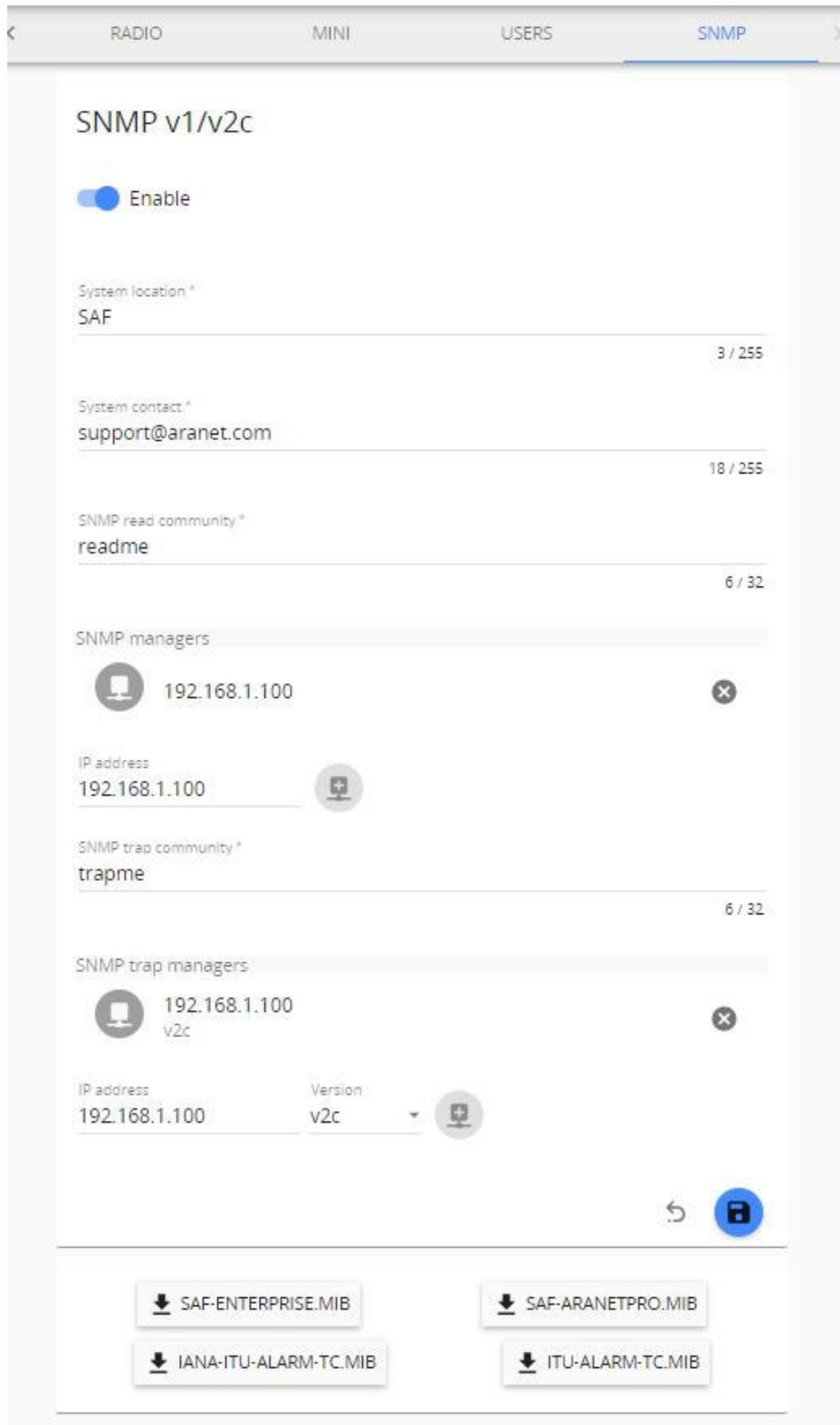

3.7 Integrations

Aranet PRO/PRO Plus integration possibilities are license-based. Each integration’s license is purchased separately. Aranet integration with 3rd party systems is possible using MQTT, Modbus and Aranet Cloud functionality on the Aranet PRO/PRO Plus base station.

3.7.1 MQTT

To use Aranet PRO/PRO Plus as MQTT publisher it is necessary to have:

- A software/application which can make data requests and receive data in MQTT format (subscribe to MQTT data reception), for example, account on *Amazon AWS* or *Microsoft Azure* cloud computing platforms.
- Access to some MQTT broker that is necessary to obtain data from Aranet PRO/PRO Plus base station and then send it to the user software.
- A valid MQTT license file uploaded on Aranet PRO/PRO Plus base station.

MQTT menu is where you setup connection to your MQTT broker.

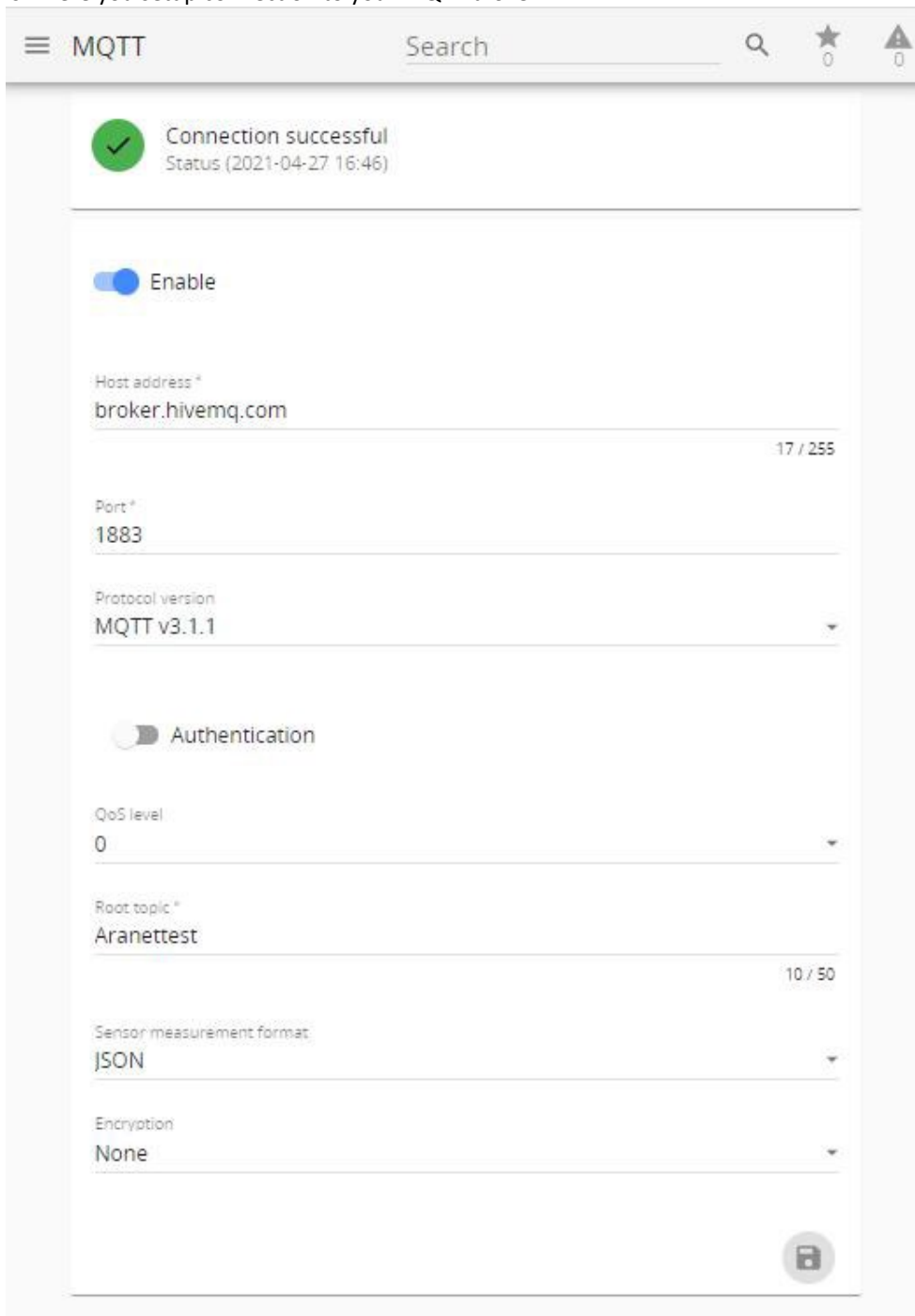

- 1) **Enable** – allows enabling/disabling MQTT data transmission from Aranet PRO/PRO Plus base station;
- 2) **Host address** – allows configuring IP address or hostname for the MQTT broker;
- 3) **Port** – allows selecting the TCP port used for the connection to the MQTT broker. The most common ports are 1883 or 8883;
- 4) **Protocol version** – allows selecting MQTT protocol version used for connection to MQTT broker. The broker should support selected version;
- 5) **Authentication** - upon necessity allows enabling additional authentication for the connection to MQTT broker and type in:
 - a. Username and
 - b. Password for such connection authentication;

The screenshot shows a configuration form for MQTT authentication. At the top, there is a toggle switch labeled 'Authentication' which is turned on (blue). Below it are several input fields and dropdown menus:

- Username ***: A text input field containing the text 'mqtt_andrey'.
- Password ***: A password input field with a masked password represented by a series of dots.
- QoS level**: A dropdown menu currently set to '0'.
- Root topic ***: A text input field containing the text 'Aranettest', with a character count '10 / 50' displayed to the right.
- Sensor measurement format**: A dropdown menu currently set to 'JSON'.

- 6) **QoS level (0, 1 or 2)** for MQTT message delivery on the MQTT broker can be selected as necessary;
- 7) **Root topic** – allows selecting root topic name with what MQTT messages will be published from Aranet PRO/PRO Plus base station on MQTT broker. In our example, we will use the name **Aranet**;
- 8) **Sensor measurement format** – allows selecting format (*raw, JSON or Azure*) in which MQTT messages from Aranet PRO/PRO Plus base station will be published on MQTT broker;
- 9) **Encryption** - upon necessity allows configuration of additional encrypted certificates (*TLS version 1.1, 1.2 or 1.3*) to be used for the more secure connection to the MQTT broker;
 - a. Validate host certificate – enable to upload necessary secure connection certificates;
 - b. click **MQTT_CA.CRT** to upload root CA certificate in PEM format for MQTT broker;
 - c. Supply client certificate - enable to upload the device public certificate and private key for secure connection to MQTT broker;
 - d. click **MQTT_CLIENT.KEY** to upload the Aranet PRO/PRO Plus base station private key for secure connection to MQTT broker;
 - e. click **MQTT_CLIENT.CRT** to upload the Aranet PRO/PRO Plus base station public key for secure connection to MQTT broker;

Encryption
 TLSv1.3

Validate host certificate



 Host CA certificate
 1024/2048 bit PEM encoded

 MQTT_CA.CRT

Supply client certificate

 Client private key
 1024/2048 bit PEM encoded

Signature:
 SHA256:0D:02:AD:D2:F3:B0:5D:1B:58:CB:DF:78:FC:28:B6:E1:1B:F1:46:9
 B:DF:2F:CE:D2:B4:6B:B4:F8:A6:F6:93:93



 MQTT_CLIENT.KEY  REGENERATE

 mqttClient.csr



 Client certificate
 1024/2048 bit PEM encoded

 MQTT_CLIENT.CRT

10) When all necessary configuration parameters are entered, they should be saved by pressing the blue **Save**  icon.

If configured MQTT connection is successful, then **Connection successful** message will be shown on the top of the page also showing the precise time when the connection was established.

For more MQTT connections settings examples refer to <https://aranet.com/software/>

3.7.2 Aranet Cloud

Aranet Cloud menu is where you setup connection to Aranet Cloud.

Aranet Cloud is a Plug & Play Cloud solution for Aranet IoT ecosystem. Aranet Cloud is Enterprise grade solution for centralized access and management of Aranet data, automated data monitoring and possibility to set up customized notifications for sensor measurements.

Aranet Cloud usage does not require integrator involvement or third-party solutions to enable centralized and remote data access for any number of sensors and bases. All sensors are available at one place – no need to switch between base stations or build solutions how to access remote locations

Every organization can set up trial Aranet Cloud account with access for a period of 30 days.

Before setting up an Aranet PRO/PRO Plus base station on the Aranet Cloud platform a couple of things should be verified and provided:

- User has any type of device with a working Internet connection and WEB browser installed on it.
- User has access to an e-mail account that can be used for new account registration in the Aranet Cloud platform.
- Aranet PRO/PRO Plus base station is properly connected to the Internet and has at least firmware version 2.4.6. Aranet Cloud receives data from base stations using HTTPS protocol on TCP port 443.

- 1) Open aranet.cloud in new browser tab or window and log in with your credentials; If you do not have user account, please register new user account.
- 2) Go to **Settings** and click **NEW BASE** button to register new Aranet Pro base;

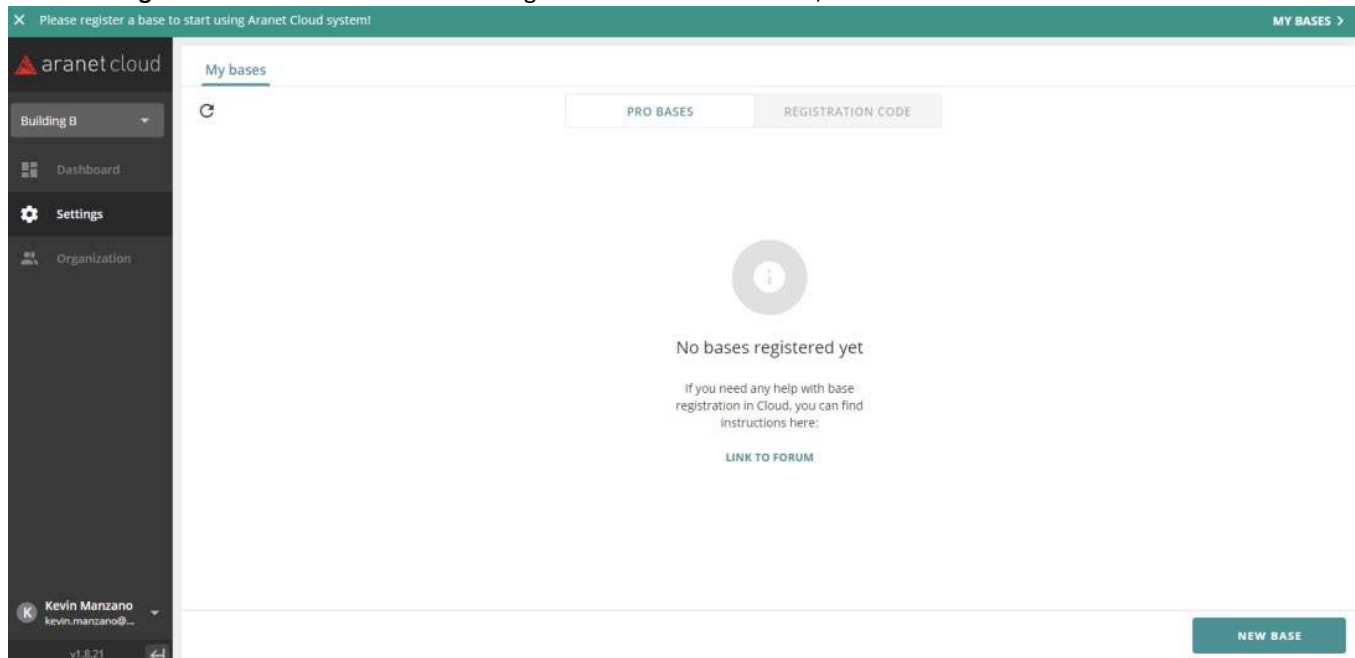

- 3) Remember or copy to clipboard generated registration code;

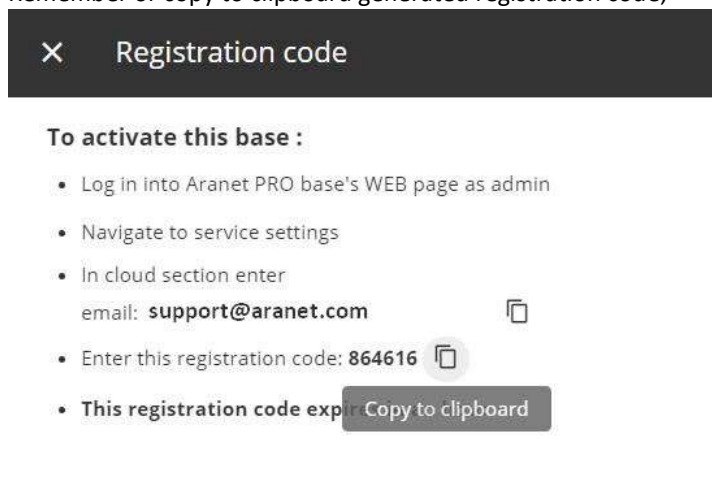

- 4) Switch back to Aranet PRO/PRO Plus webpage, make sure about *Cloud service availability* – icon must be green*, and type in or paste from clipboard e-mail address you are registered with in **aranet.cloud**, and generated registration code;

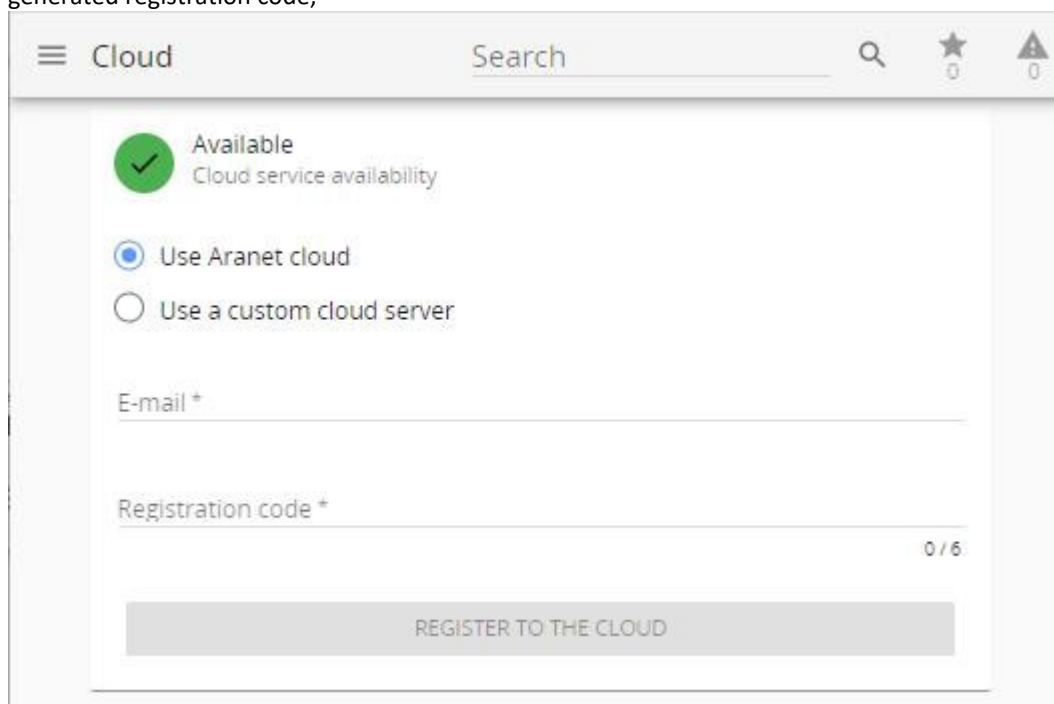

The screenshot shows a web interface for cloud registration. At the top, there is a navigation bar with a hamburger menu icon, the word "Cloud", a search bar, and icons for search, favorites, and notifications. Below the navigation bar, there is a status indicator: a green checkmark in a circle followed by the text "Available" and "Cloud service availability". Underneath, there are two radio button options: "Use Aranet cloud" (which is selected) and "Use a custom cloud server". Below these options are two input fields: "E-mail *" and "Registration code *". The "Registration code *" field has a character count of "0 / 6". At the bottom of the form is a button labeled "REGISTER TO THE CLOUD".

- 5) Click **REGISTER TO THE CLOUD**.

New webpage will open informing about registering result. Reload page to see information about cloud connection state.

* If Cloud service is unavailable and icon is red, then check base Internet connection.

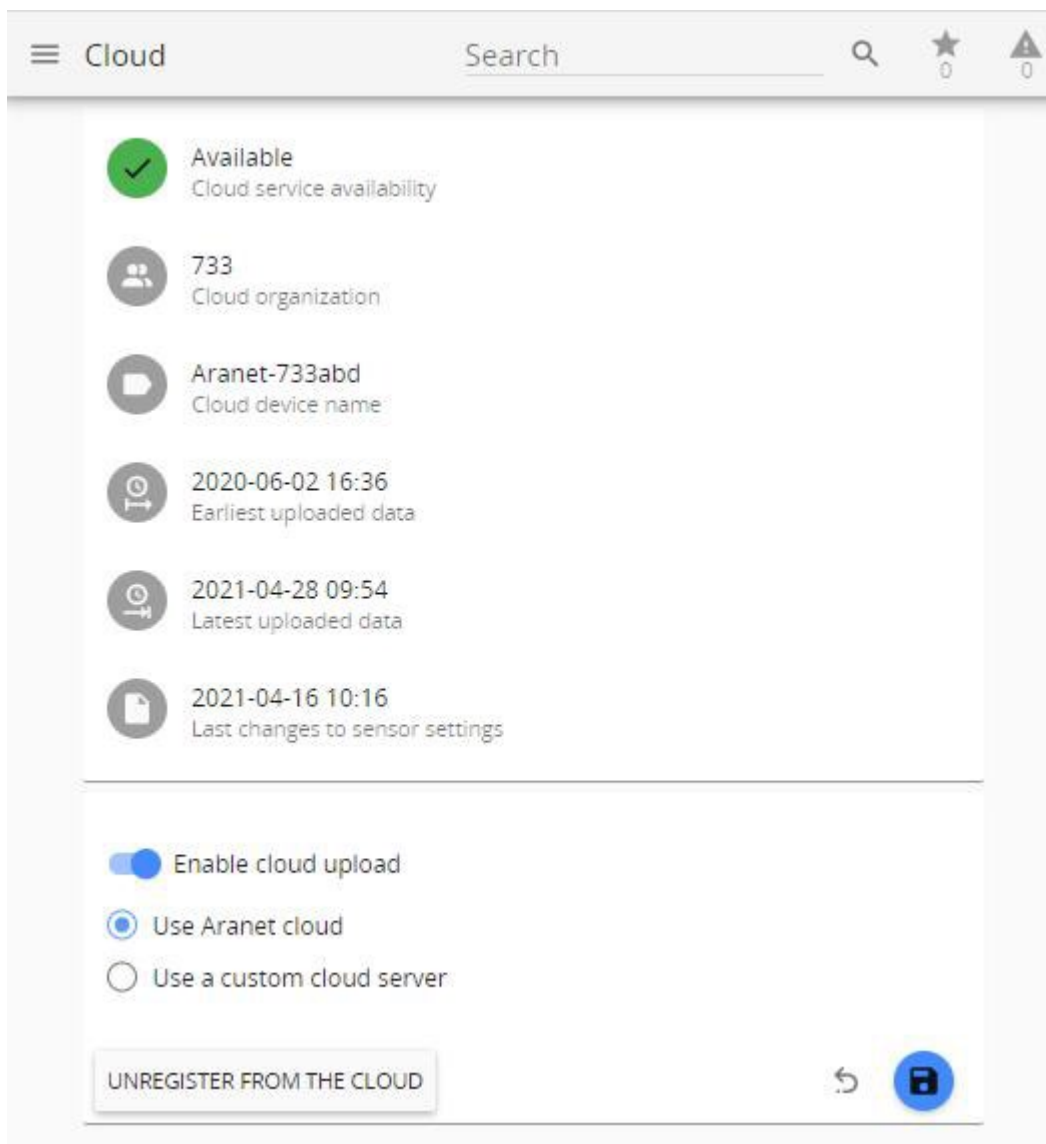

Aranet PRO/PRO Plus base will start its' paired sensor measurement data upload to the Aranet Cloud platform. The sensor data upload process depending on sensor data amount and data connection speeds between Aranet PRO/PRO Plus base station and Aranet Cloud system can take up to 20 – 30 minutes. During this process sensor data will gradually appear in the Aranet Cloud organization.

You can pause uploading sensor data and backup files by switch off “**Enable cloud upload**”. If you wish to unregister Aranet PRO/PRO Plus base from cloud, click **UNREGISTER FROM THE CLOUD**. For more information about Aranet Cloud refer to [Aranet Cloud User guide](#). For Aranet Cloud usage guidelines please refer to [Aranet Cloud forum](#).

3.7.3 Modbus

Aranet PRO/PRO Plus Modbus TCP/IP feature currently supports "Input register" object types. All other types can be defined in the configuration file, but they will be ignored. It refers also to function codes. Only function code 4 is supported (read "Input register").

Aranet PRO/PRO Plus appears in Modbus networks as **server (slave)** having its own *server(slave) ID*. By default, Aranet PRO/PRO Plus *server (slave) ID* is "1".

Notes for client side:

- Register size: 16 bits;
- Endianness - big-endian with high word first:
 - high byte first;
 - high word first (for 2 register/32-bit values).
- Supports only:
 - Modbus function: read input registers (code: 4)
 - Modbus data type: input registers (any address can be used in supported range: 0-65535)
- Used Modbus TCP exceptions
 - In case if unsupported function is being requested, message with "ILLEGAL_FUNCTION" code will be replied.
 - In case if unavailable registry address is being requested, message with "ILLEGAL_DATA_ADDRESS" code will be replied. This exception is sent also in case if address is colliding with any other registry address.
 - In case if uninitialized registry address is being requested, message with "ILLEGAL_DATA_VALUE" code will be replied. Address of the registry exists, but valid data of measurement has not been assigned yet.

Modbus menu is where you setup connection to Aranet PRO/PRO Plus.

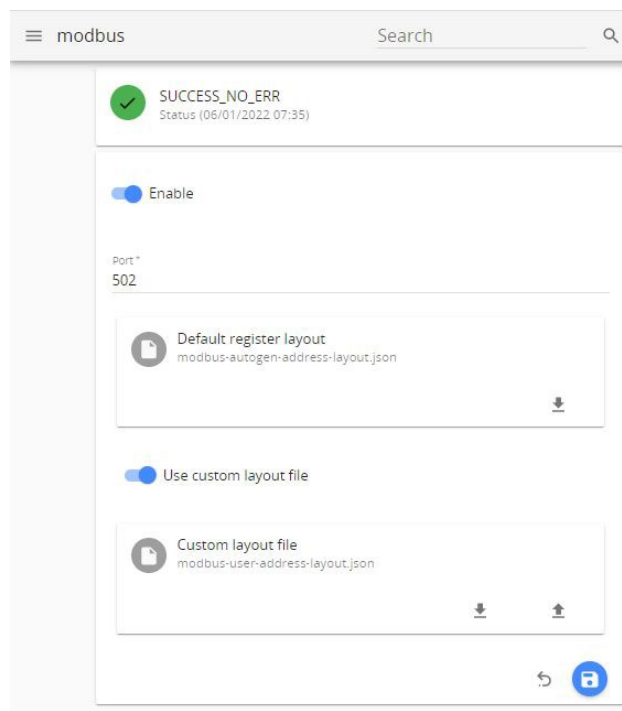

- 1) **Enable** – allows enabling/disabling Modbus TCP/IP on Aranet PRO/PRO Plus base station;
- 2) **Port** – allows selecting the TCP port used for the connection to the Modbus *client (master)*. The most common port is 502.
- 3) **Default register layout** – autogenerated Aranet PRO/PRO Plus Modbus addresses layout file in *json* format can be downloaded here. ([See layout file example below](#)).
- 4) **Use custom layout file** – when enabled, custom Modbus addresses *json* file can be uploaded to the Aranet PRO/PRO Plus base here as well as downloaded back from base station.
- 5) **Save** or **Cancel** changes.

Autogenerated Aranet PRO/PRO Plus Modbus addresses layout file example.

Most important explanations about addresses are given in downloaded *json* file as *//comments*:

```
////////////////////////////////////
// Aranet PRO Modbus mapping configuration description.
// The configuration supports the inputRegisters protocol object type.
// Each type has its own address offset value (e.g., 30000).
// Each offset value is expected to be in a range: 0-65535// Sensors can be mapped
// for each object type.
// Each sensor has:
//   - offset value (e.g., 0);
//   - set of measurements (e.g., temperature, humidity, battCharge, rssi).
// Each measurement has:
//   - offset value (which must be unique in between particular sensor's
// measurement offset values, e.g., temperature - 1, humidity - 3, rssi - 5,
// battCharge - 6, etc.);
//   Registry address of specific measurement is the sum of offsets, .e.g,
// protocol object type inputRegisters (30000) + sensor X offset (0) + measurement
// Y offset (1) which makes Input register's address value 30001 for the sensor's X
// measurement Y.
//   - sum of offsets (e.g., registry address) must be in a range: 0-65535
//   - data type (int16, int32, uint16, uint32, float32).
//   This datatype determines how particular measurement must be interpreted
// (as integer or float value).
//   Data type also determines the registry size needed to encode the value
// into bytes. Size of two bytes is used for a single Modbus registry.
//   The selected data type also affects an offset value for the next
// measurement address, e.g., if temperature's (1) data type is float then next
// measurement offset value must be 3 as temperature measurement offset is 1 and
// it's data type length is 2.
// Address overlapping will be reported as a configuration error.
////////////////////////////////////

{
  "version": "1.0.0",
  "inputRegisters": {
    "offset": 0,
    //////////////////////////////////////
    "5245796": { // Sensor 500B64; Address: 0
      "offset": 0,
      "motorseconds": { // Address 0: measurement motorseconds in s
        "offset": 0,
        "dataType": "int32",
        "multiplier": 1
      },
      "motorsecondscumulative": { // Address 2: measurement motorsecondscumulative in s
        "offset": 2,
        "dataType": "int32",
        "multiplier": 1
      },
      "battCharge": { // Address 4: divide by 100 to get battCharge in fraction
        "offset": 4,
        "dataType": "int32",
        "multiplier": 100
      },
      "rssi": { // Address 6: measurement rssi in dBm
        "offset": 6,
        "dataType": "int32",
        "multiplier": 1
      },
      "time": { // Address 8: measurement time in seconds
        "offset": 8,
        "dataType": "uint32",
        "multiplier": 1
      }
    },
    //////////////////////////////////////
    "1049873": { // Sensor 100511; Address: 20
      "offset": 20,
      "temperature": { // Address 20: divide by 1000 to get temperature in C
        "offset": 0,
        "dataType": "int32",
        "multiplier": 1000
      },
      "humidity": { // Address 22: divide by 10 to get humidity in %
        "offset": 2,
        "dataType": "int32",
        "multiplier": 10
      },
      "battCharge": { // Address 24: divide by 100 to get battCharge in fraction
        "offset": 4,
        "dataType": "int32",
        "multiplier": 100
      }
    }
  }
}
```

```
},
"rssi": {          // Address 26: measurement rssi in dBm
  "offset": 6,
  "dataType": "int32",
  "multiplier": 1
},
"time": {          // Address 28: measurement time in seconds
  "offset": 8,
  "dataType": "uint32",
  "multiplier": 1
}
},
////////////////////////////////////////////////////////////////////////////////////////////////////////////////////////////////
}
```

Autogenerated file can be used as template for Custom layout file creation: you can edit it to read needed sensors and measurements only.

4 SENSORS' SPECIFIC NOTES

4.1.1 Weight Sensor

To reset the zero offset of weight (tare), click on the **TARE** button. The last measured tared and (untarred weight), as well as the date and time of the last tare event will be indicated.

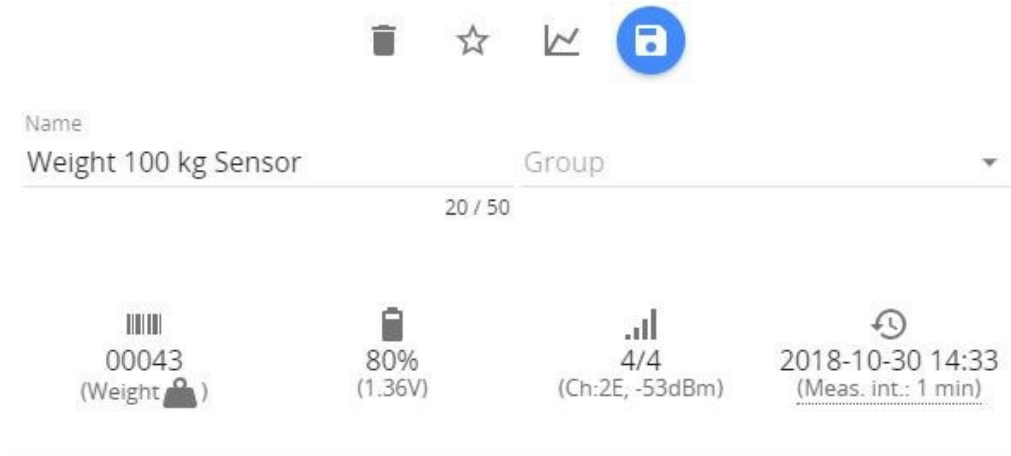

By default, the graph of the **Weight Sensor** will display measurements of a tared weight. To display the untarred

weight in the graph, click the **Tune**  button and tick the "Show" box.

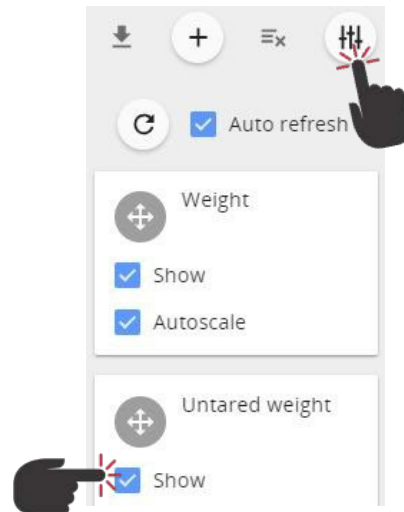

4.1.2 Soil (Substrate) VWC, EC and T Sensor

The soil (substrate) VWC, EC and T Sensor displays the **Volumetric Water Content** and **Pore Water Electrical Conductivity** measurements values (**Temperature** is displayed on **Graph**).



Under the “**Sensors**” menu it is possible to select the calibration of the VWC and EC (pore water) calculation method, by selecting *Topp G.C., Mineral Soil, Rockwool Ecover, or Rockwool Grodan*.

VWC is defined as 6th order polynomial of *Epsilon*:

$$\text{VWC} = a + b \cdot \epsilon + c \cdot \epsilon^2 + d \cdot \epsilon^3 + e \cdot \epsilon^4 + f \cdot \epsilon^5 + g \cdot \epsilon^6,$$

where ϵ is the apparent dielectric permittivity calculated from RAW by

$$\epsilon = (2.887e-09 \cdot \text{RAW}^3 - 2.080e-05 \cdot \text{RAW}^2 + 5.276e-02 \cdot \text{RAW} - 43.39)^2.$$

Presets are available and based on calibration results provided by **MeterGroup**:

#	Manufacturer	Product	Calibration date	EC (dS/m)	T (°C)	Slab size	Teros-12 placement
1	Grodan	GT Master	2021 May	4.00 (0.02)	22 (2)	H10 x 15 x 17 cm	2x, inserted horizontally, 4 cm from bottom of slab
2	Grodan	Prestige	2021 May	4.00 (0.02)	22 (2)	H7.5 x 17 x 15 cm	2x, inserted horizontally, 4 cm from bottom of slab
3	Ekover	Grunt Tomato	2021 May	4.00 (0.02)	22 (2)	H7 x 20 x 14.5 cm	2x, inserted horizontally, 4 cm from bottom of slab
4	Ekover	Grunt Green 1.0	2021 May	4.00 (0.02)	22 (2)	H7.5x17x20 cm	2x, inserted horizontally, 4 cm from bottom of slab
5	Ekover	Grunt Green 2.0	2021 May	4.00 (0.02)	22 (2)	H7.5x17x20 cm	2x, inserted horizontally, 4 cm from bottom of slab
6	Ozo Golf Club		2021 May	0.25	22 (2)	NA	2x
7	Grodan	DM32 40/40 HUGO	2021 October	2.1	NA	H14.5x14.5x13.75 cm	2x, inserted horizontally, 7 cm from bottom of slab
8	Charcoir	3 Liter BioPot	2022 April	1.3	NA	16x16x16 cm	2x, inserted horizontally, 1.25 inches from bottom of slab
9	Kekkila	Natural Control	2022 July	4.5	NA	24x12x19 cm	2x, inserted horizontally, 4 cm from bottom of slab

Coefficient values (4 significant figures) used in Pre-sets:

#	VWC preset name	6 (g)	5 (f)	4 (e)	3 (d)	2 (c)	1 (b)	0 (a)	
1 (default)	Topp G.C. et al. (1980)	0	0	0	4.300e-06	-5.500e-04	2.920e-02	-5.300e-02	doi:10.1029/WR016i003p00574
2	mineral soil	0	0	-2.925e-08	7.293e-06	-6.845e-04	3.129e-02	-3.612e-02	recommendation by MeterGroup; 0-8 dS/m, 0-60% VWC
3	rockwool Ekover	0	2.070e-09	-5.405e-07	5.443e-05	-2.649e-03	6.858e-02	-4.324e-02	T=22 °C; EC=4 dS/m; Tomato/Green 1.0/Green 2.0; 4 cm from bottom
4	rockwool Grodan	0	0	-7.785e-08	1.756e-05	-1.395e-03	5.224e-02	-5.440e-02	T=22 °C; Prestige/GT Master/DM32 40/40 HUGO
5	coco or peat	0	0	0	0	0	6.276e-03	2.420e-01	30-60% VWC; Charcoir/Kekkila
6	soiless media	-1.655e-10	4.353e-08	-4.473e-06	2.261e-04	-5.812e-03	7.991e-02	-6.141e-02	recommendation by MeterGroup;
	custom	0	0	0	0	0	0	0	write calibration conditions here

Should you require to modify the calibration curve, change the required calibration values. If any of the preset calibration values are changed, the method type will be change to "Custom".

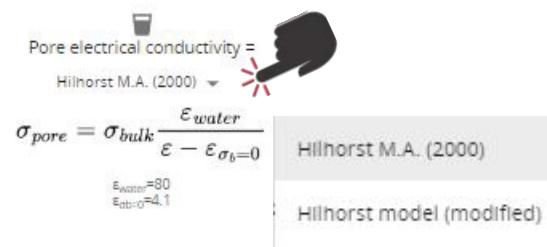
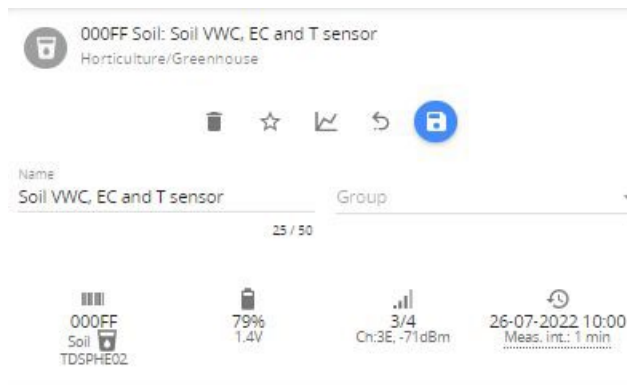

Pore electrical conductivity is calculated using Hilhorst M.A. formula:

$$\sigma_{pore} = \frac{\epsilon_{water}}{\epsilon - \epsilon_{\sigma_b=0}} \sigma_{bulk}$$

Where $\epsilon_{water} = 80$ and $\epsilon_{\sigma_b=0} = 4.1$

For better precision of smaller values modified formula can be selected:

$$\sigma_{pore} = \frac{\epsilon_{water} - \epsilon_{\sigma_b=0}}{\epsilon - \epsilon_{\sigma_b=0}} \sigma_{bulk}$$

where $\epsilon_{water} = 80$ and $\epsilon_{\sigma_b=0} = 1$

The custom value of $\epsilon_{\sigma_b=0}$ can be entered as well.

The graph of soil sensors by default displays Temperature, Volumetric Water Content and Pore Electrical Conductivity.

Use the **Tune**  button, to display the Bulk Electrical Conductivity and dielectric permittivity (ϵ).

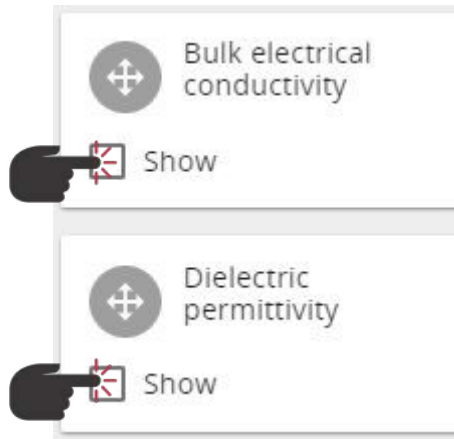

!NOTE! It is possible to order sensor **calibration coefficients for your substrate** in SAF Tehnika. Please contact support@aranet.com for details.

4.1.3 4-20 mA and Voltage Sensors

The **4-20mA Sensor** can be used for current measurements (within a range of 0 - 30 mA) and the **Voltage Sensor** - for voltage measurements (within a range of -32 to +32 VDC).

Under the “**Sensors**” menu, it is possible to enable conversion from mA/V to other values depending on transducer type connected to mA/V Sensor.

If required, switch the **Conversion** on, and use the drop-down menu to choose a predefined *Dimension* and *Unit*. If the required *Dimension* or *Unit* is not in the list, choose “*Other*” as the Dimension and input your own measurement unit.

Define the reference values for two measurement points (i.e., sensor’s min/max voltage). For example, set 0 V equal to 100 of your units and 32V equal to 1000 of your units. The values will then be linearly calculated according to these two reference points.

00011:

Name: 00011 Group: 0 / 50

00011 (Voltage 4V) 66% (1.26V) 4/4 (Ch:2E, -55dBm) 2018-10-19 16:38 (Meas. Int.: 1 min)

-32.00 V 32.00 V

Notification delay: None

Conversion: Dimension: Other Unit: my units

8 / 10

Please provide reference points

4V 1	0	V = 100	my units
4V 2	30	V = 1000	my units

4.1.4 Stem Micro-Variation sensor

To show the correct stem diameter value with the Stem Micro-Variation sensor it is necessary to configure it upon installation. The process can be done in the following steps:

1. First existing stem diameter should be measured with a ruler or caliper (*in our example 8mm*):



2. Then sensor detecting element should be mounted on the stem:



- Sensor electric current reading on Aranet PRO base station graphical user interface should be checked and recorded (*in our example 5.12mA*)

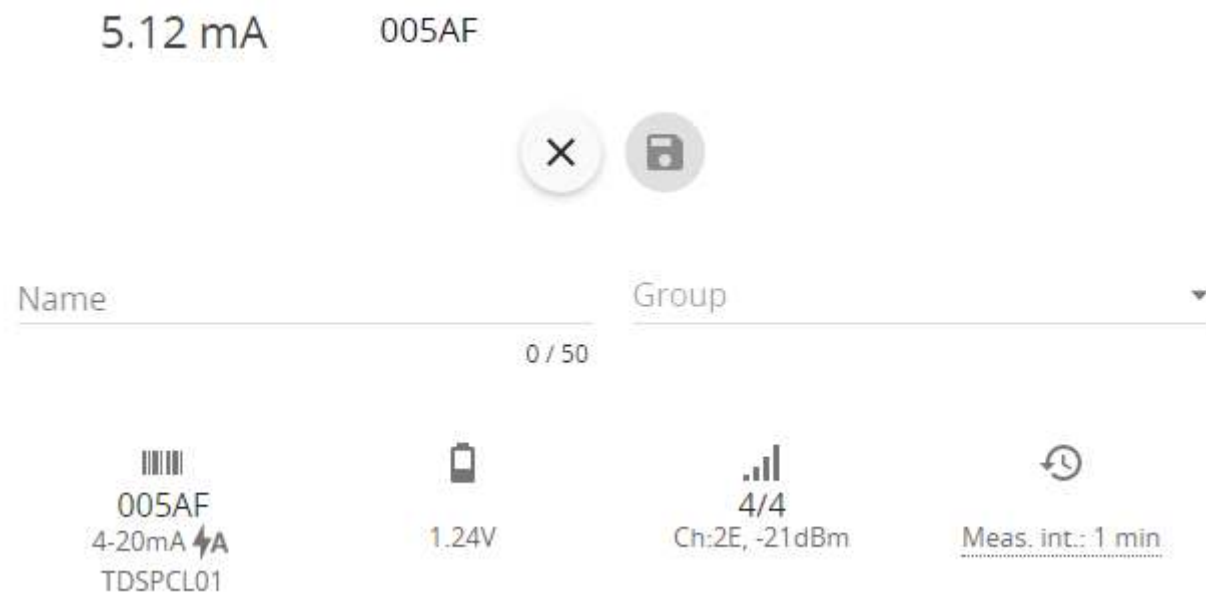

- Next it is necessary to determine how much from the sensor measurement range (4–20 mA) is already used by the current measurement. Here from the recorded current value then minimal reading value = 4mA should be subtracted (*in our example $5.12\text{ mA} - 4\text{ mA} = 1.12\text{ mA}$*)
- Then subtraction value obtained in the previous point should be divided by 0.01mA that is the resolution step of electric current measurements (*in our example $1.12\text{mA}/0.01\text{mA} = 112$*). This is the measurement range in step units that are already used by the sensor.
- Next used electric current measurement step unit value should be multiplied by 0.003125mm that is the value of one measurement step unit in millimeters (*in our example $112 * 0.003125\text{mm} = 0.35\text{mm}$*). The obtained value should be rounded to 2 digits after the comma, and it is the measurement range used by the sensor in millimeters (*in our example 0.35mm*);
- Next, the used measurement range in millimeters should be subtracted from stem diameter measured in point 1 (*in our example $8\text{mm} - 0.35\text{mm} = 7.65\text{mm}$*) and here we obtain stem diameter value that corresponds to 4mA electric current reading of the sensor
- Then measurement value in millimeters should be determined that correspond to max electric current measurement value 20mA. Sensor measurement range in millimeters is 5mm, so this value should be added to the value obtained in point 7 to get the value corresponding to the 20mA electric current reading of the sensor (*in our example $7.65\text{mm} + 5\text{mm} = 12.65\text{mm}$*)
- Finally, previously obtained millimeter values for 4mA and 20mA should be entered in Stem Micro-variation sensor **Conversion** configuration in Aranet PRO base station graphical user interface section **Sensors** → **SENSORS** after that user will be able to see sensor measurements in mm of the stem diameter:

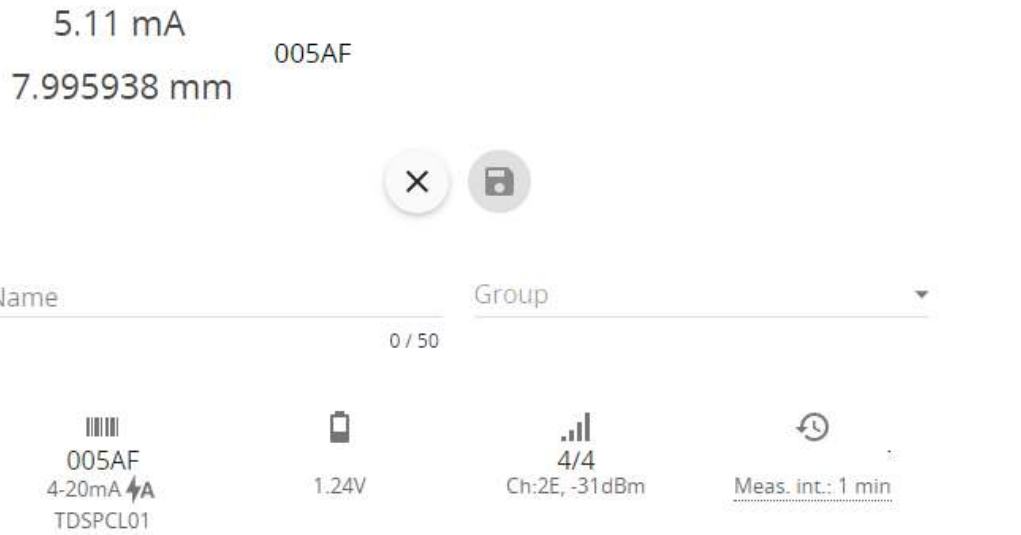
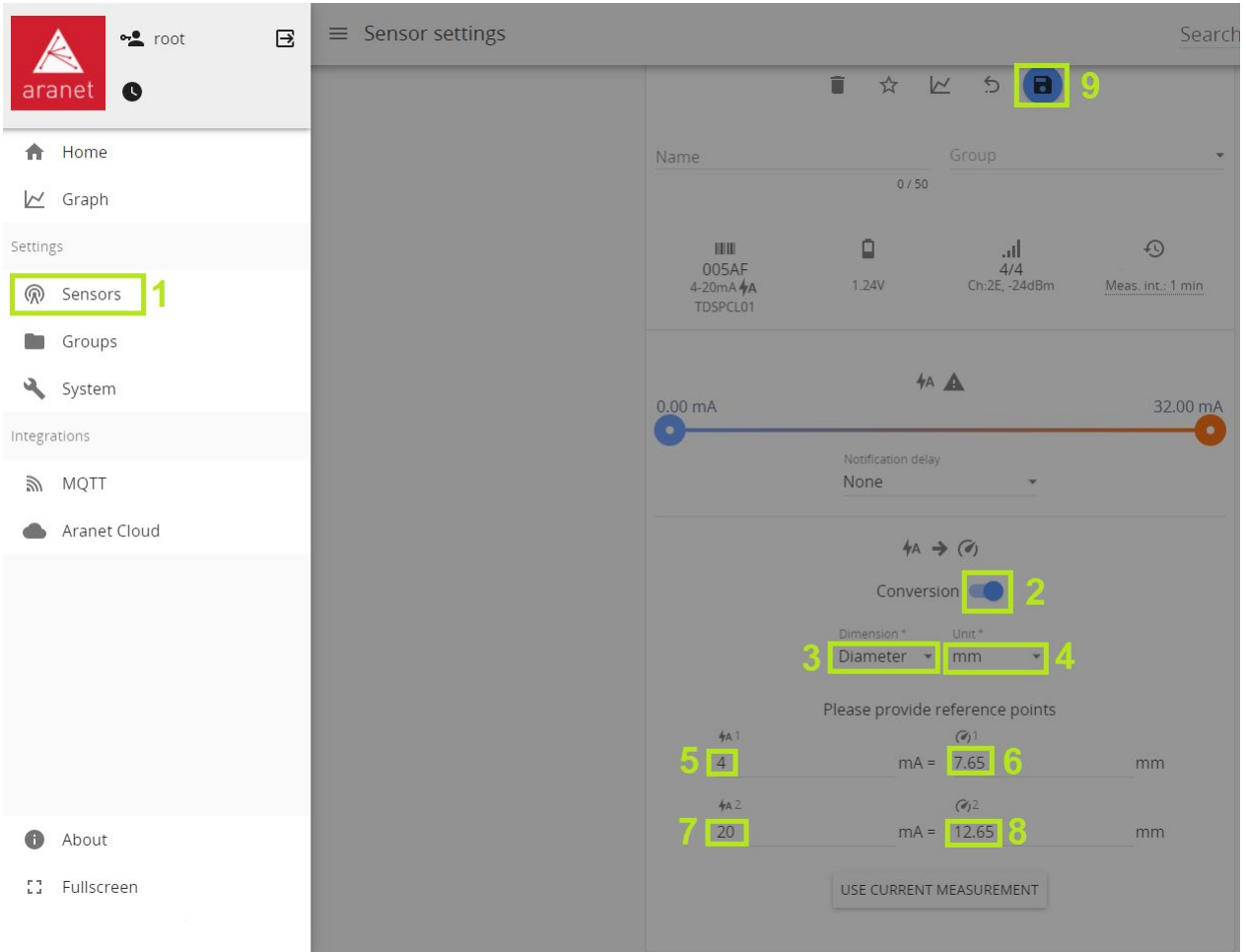

4.1.5 Ultrasonic Distance sensor

Aranet Ultrasonic Distance sensor uses ultrasound to measure the distance to an object. A high frequency sound wave is emitted by the device, measuring the time it takes for the wave to reach the object and then return to the sensor. Aranet Ultrasonic Distance sensor works with a wide range of liquid and non-liquid materials. Various practical applications of the sensor include measuring grain level in a silo, or the level of a liquid in a container, as well as other uses.

When pairing Ultrasonic Distance sensor, it is possible to set measurement thresholds and reference point, if needed.

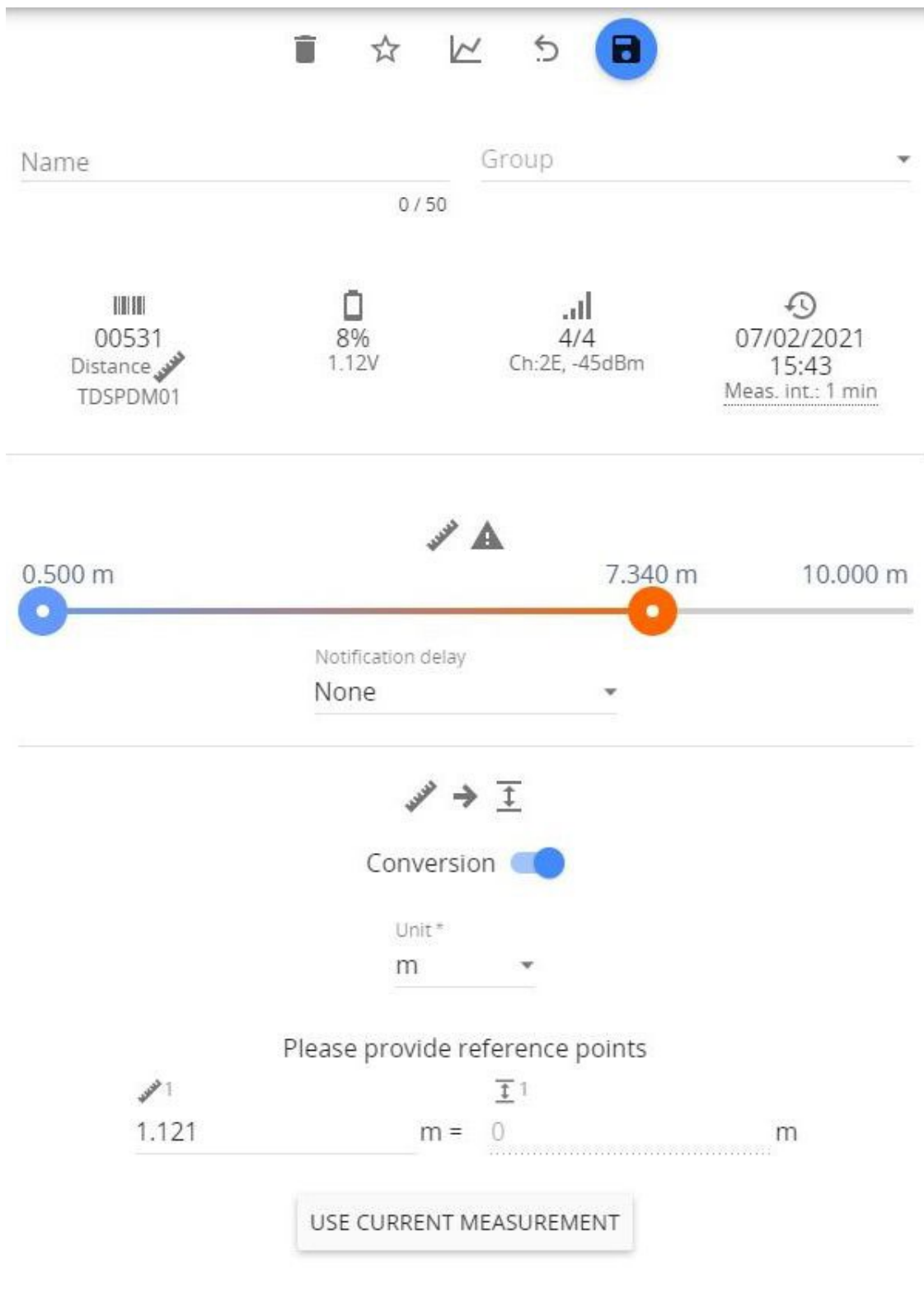

Enable conversion switch and select Units from drop-down list. Then enter Zero reference point manually or press “USE CURRENT MEASUREMENT” button to use current measurement as Zero point.

4.1.6 CO2 and Temperature sensor

The sensor comes factory calibrated, but when recalibration is needed it can be done in the following steps:

- 1) Screw out top part of the sensor;
- 2) Small dipswitch on the PCB board should be set in **MAN** position;
- 3) Press and hold **CALIBR.** button till red LED starts to blink;
- 4) Now sensor should be left in the fresh air outdoor environment during the calibration process for 30 minutes without any person nearby.
- 5) When the calibration process is finished, screw on the sensor's top part back.

4.1.7 Pulse Counter sensor

The sensor counts the number of mechanical contact closes. The applications include electricity meters, water flow monitoring etc. Both count-per-measurement interval and the cumulative count are registered. The SensorHub software can convert and represent these measurements in the preferred metric (Volume, Current, Torque etc.) and preferred units (liters, joules, watt-hours etc.).

The screenshot shows the SensorHub interface for a sensor named "0095E: Pulse Counter". At the top, there are icons for deleting, favoriting, graphing, refreshing, and locking. Below this, the sensor's name "Pulse Counter" and a "Group" dropdown menu are visible. A progress indicator shows "13 / 50".

The main display area contains four data points:

- 0095E**: Contact Pulse (TDSPIC02)
- 84%**: 1.42V
- 3/4**: Ch:3E, -66dBm
- 28/10/2021 17:30**: Meas. int.: 1 min

Below the data points, there is a "Conversion" section with a toggle switch that is turned on. It includes dropdown menus for "Dimension*" (set to "Volume") and "Unit*" (set to "l").

A note says "Please provide reference points". Below this, there is a conversion formula: $1 \text{ pulses} = 10 \text{ l}$.

4.1.8 NH3 Sensor kit

NH3 sensor kit for use in laboratories, livestock, poultry farms and sewage treatment plants to monitor the leakage of ammonia gas and give an alarm to protect humans and animals.

Kit consists of DOL53 sensor, wire junction box TDADCA01 and Aranet 0-10 VDC transmitter. Sensor and transmitter are connected to junction box which is powered by 220-240 VAC. In addition, Aranet 0-10V transmitter is powered by 1 AA size battery. Connection scheme is following:

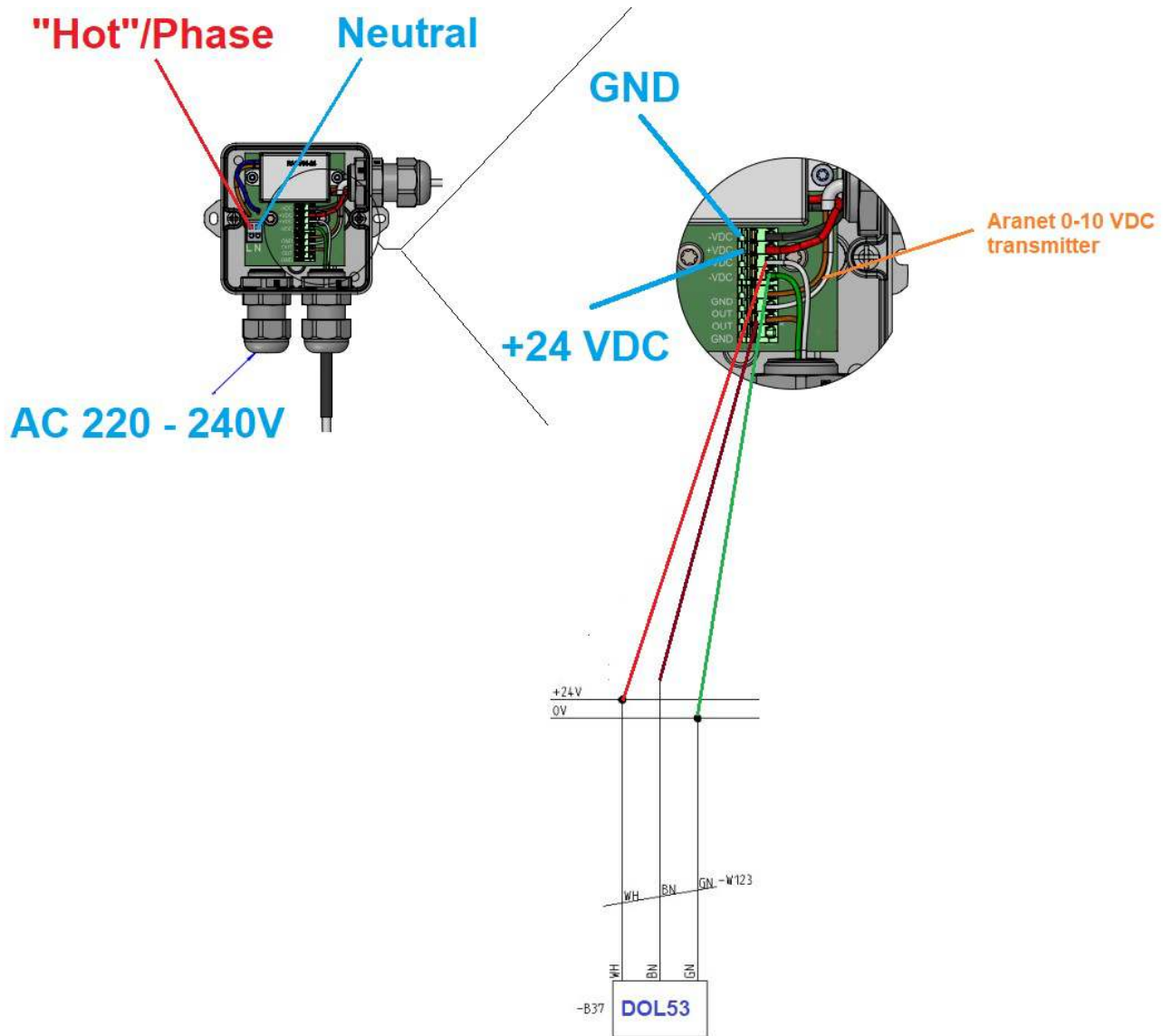

5 LEGAL INFORMATION

5.1 TERMS OF USE

Aranet PRO base station - The Customer is obliged to guarantee the usage, maintenance, and preservation of the Equipment at their own expense in a way that excludes the Equipment's theft, loss, destruction, harming and/or damaging (including as a result of mechanical damages, moisture, liquid related damages, lightning and/or other similar events). Base station may only be used indoors, it needs to be protected from environmental impact (snow, rain, direct sunlight).



NOTE! For the full Terms and Conditions, please visit: <https://aranet.com/terms-and-conditions/>

5.2 WARRANTY

ARANET WARRANTY

SAF, which includes SAF Tehnika and SAF North America, LLC, has built a reputation on providing high- quality products to its customers and it stands behind each product it manufactures, including Aranet. Accordingly, SAF warrants the products it manufactures will be free from defects in material or workmanship and will function in accordance with their official written specifications for a minimum of two years as long as they are used and stored in accordance with industry standards and any unique handling instructions provided by SAF. While SAF warrants all of its products will function in accordance with their official written specifications, SAF does not warrant all products will function uninterrupted or error free. Further, verbal or informal specifications will not be covered by the Warranty. To be enforceable, a product specification must be stated in SAF official literature. No product shall be considered defective or otherwise in breach of the Warranty simply because it needs to be adapted to or otherwise does not comply with the laws and regulations (including frequency range) of the customer's home country or jurisdiction.

WARRANTY TERM

The Warranty shall apply to Aranet 24 months after it is shipped to the customer. An invoice itemizing a product's warranty period shall be included with the product when it is delivered to the customer. No verbal extensions or modifications of the Warranty shall be enforceable.

WARRANTY LIMITATIONS

The Warranty shall be voidable at SAF's discretion in any circumstance where a SAF manufactured product has been damaged by a customer's conduct or an act of God including, but not limited to: a.) damage caused by the customer's improper use of the product; b.) mechanical damage caused by a physical impact; c.) the accumulation of moisture or water in a product's housing; d.) damage caused by wind, hail, rain, animal, insect or other environmental events; and e.) electromagnetic damage caused by a power surge, overvoltage, or a strike of lightning. Finally, for the Warranty to be effective, all repairs and modifications to a product, including its software, must be performed by SAF and the Warranty shall be voidable at SAF's discretion in any circumstance where a customer or its agent opens a product's housing or otherwise attempts to modify or repair a product, including its software, without SAF's permission. There are currently no third parties authorized to repair SAF's products.

PRODUCT REPAIRS & LIABILITY LIMITATIONS

In the event a SAF manufactured product does not conform with the Warranty, SAF will fix or replace the non-functioning product in accordance with the return and repair policy below. These options shall be a customer's sole remedy.

IN NO EVENT SHALL SAF BE LIABLE FOR ANY INDIRECT, INCIDENTAL, SPECIAL OR CONSEQUENTIAL DAMAGES ARISING OUT OF OR RELATING TO THE SALE OR USE OF ITS PRODUCTS, WHETHER OR NOT SAF HAS ADVANCE NOTICE OF THE POSSIBILITY OF SUCH DAMAGES. SAF'S SOLE AND EXCLUSIVE

MAXIMUM LIABILITY FOR ANY LEGAL CLAIM ASSOCIATED WITH A SALE COMPLETED PURSUANT TO THESE TERMS OR THE WARRANTY, REGARDLESS OF WHETHER SUCH CLAIM SOUNDS IN CONTRACT OR TORT, LAW OR EQUITY, SHALL NOT EXCEED THE PRICE OF THE PRODUCT(S) SOLD TO A GIVEN CUSTOMER. BY SUBMITTING THEIR PURCHASE ORDER, EACH CUSTOMER KNOWINGLY WAIVES ANY AND ALL CLAIMS AND DAMAGES PRECLUDED BY THE FOREGOING LIMITATIONS INCLUDING, BUT NOT LIMITED TO, ALL CLAIMS ASSOCIATED WITH PERSONAL INJURIES (INCLUDING ANY CLAIMS BASED IN PRODUCT OR STRICT LIABILITY), LOST REVENUE AND PROFITS, LOSS OF TECHNOLOGY, LOSS OF RIGHTS OF SERVICES, UNFAIR COMPETITION AND COMMERCIAL LOSSES OF ANY KIND.

ACCEPTANCE, RETURNS & REPAIRS

If Customer has not received the goods, he can contact SAF to help solving the problem. The claim of non- received goods should be raised within 60 days from the date of payment. No assistance will be available after the term of 60 days has passed. Prior to raise a claim to SAF, Customer should ascertain that a parcel is not received by any other person in Customer's premises. Also, Customer is asked to ascertain that a parcel is not left at any of the neighbors, etc.

SAF keeps the right to perform an investigation for a period of 20 days. In the case SAF has made a decision to compensate Customer for the losses, either a new product may be sent to customer or the price for the ordered product may be returned to Customer.

If Customer is not satisfied with a received product, he can proceed as described further. Restocking and Refund is not applicable for legal entity.

Physical person who is a resident of US and Canada may require Restocking and Refund within 60 days from the date of payment. No Restocking and Refund will be available after the term of 60 days has passed.

If the Restocking is accepted by SAF, the product(s) must be returned – unused, condition as brand new, without any defects, without dirt and scratches, containing all original labels, full completion as received, in original package as received. The shipment back to SAF is on Customer's account. If Customer has failed to meet all of the Restocking rules mentioned above, SAF keeps the right to refuse the Refund, or reduce the amount of money returned.

If Customer has not requested a Restocking, Refund or raised a claim within 60 days from the date of Invoice, the product (set) is considered to be accepted by Customer.

Shipping to SAF

If the failure is discovered to a SAF manufactured product, it will be given a Return Materials Authorization ("RMA") number and should be returned to SAF by completing the RMA form at <https://aranet.com/rma/> and then shipping the non-functioning product in its original packaging (or packaging providing a similar level of protection) to one of the facilities below.

Standard shipping address is:

SAF Tehnika RMA Dep.

24a Ganibu dambis Riga LV-1005 LATVIA

All North American customers should ship their products to:

SAF North America, LLC

3250 Quentin Street, Unit 128

Aurora, Colorado 80011 U.S.A.

(720) 502-0728

All returns shall be sent to SAF at the customer's expense and shall not be considered delivered until they arrive at SAF's facilities. SAF assumes no responsibility and shall not be liable for any products damaged while in transit to SAF's facilities. SAF strongly recommends the customer to purchase an appropriate amount of insurance from the carrier they use to return the product(s) to SAF.

Inspection & Repair

Non-functioning product(s) shall be evaluated and treated as follows:

DOA. Any product discovered as non-functioning within 30 days after it is shipped to the customer, for any reason other than a customer's misuse or mishandling, shall be deemed "Dead on Arrival" or "DOA" and replaced free of charge. Aranet products will be replaced no later than 20 business days after SAF verifies its non-functioning status.

Warranty Repair. All products subject to the Warranty shall, depending on the circumstances, will be repaired or replaced free of charge within 20 business days of their arrival at SAF's facilities. Non-warranty Repairs. SAF will repair a product for a period of 5 years after it is delivered to the customer. All products repaired outside of the Warranty shall be repaired at the customer's sole expense. A quote for repair shall be provided to the customer via e-mail prior to the product being received by SAF or within a reasonable time after the product arrives at SAF's facilities. All repair and shipping costs must be paid by the customer in advance. SAF shall repair and ship the non-functioning product within 20 business days of receiving full payment for the repairs.

Post-repair Warranty

All repaired products shall be subject to the Warranty for a period of six months after they are repaired.

The additional warranty described herein may extend but shall in no way reduce any pre-existing warranty periods already applicable to the product.

Return Costs

If a given product is covered by the Warranty, SAF will pay the shipping costs associated with returning it to the customer. If a product is outside of the Warranty, the customer shall pay all costs associated with transmitting it to and from SAF. An estimated cost of return will be included in any repair invoice sent to the customer and must be paid before SAF will return a repaired product.

Shipping & Abandonment

Any non-functioning product remaining in SAF's possession for three months after a customer receives an invoice for repairs because the customer has failed to pay the invoice in question, shall be considered abandoned. A customer's rights in all abandoned products shall be considered forfeit and SAF shall have the right to reprocess such products in any manner it sees fit.

Sole Warranty

UNLESS SAF AGREES TO ADDITIONAL OR ALTERNATE TERMS IN WRITING, THE WARRANTY DESCRIBED HEREIN IS THE SOLE AND EXCLUSIVE WARRANTY OFFERED TO SAF'S CUSTOMERS, AND NO ADDITIONAL WARRANTIES ARE GIVEN OR IMPLIED, INCLUDING, WITHOUT LIMITATION, ANY IMPLIED WARRANTIES OF MERCHANTABILITY, NON-INFRINGEMENT, TITLE OR FITNESS FOR A PARTICULAR PURPOSE.

CHANGES TO THESE TERMS & CONDITIONS

We reserve the right to update or change our Terms and Conditions at any time and you should check these Terms and Conditions periodically. Your continued use of the Service after we post any modifications to the Terms and Conditions on this page will constitute your acknowledgment of the modifications and your consent to abide and be bound by the modified Terms and Conditions.

5.3 RMA (RETURN MERCHANDISE AUTHORIZATION) FORM

To file an RMA case, please fill out the form here: <https://rma.aranet.com/>

5.4 INTELLECTUAL PROPERTY RIGHTS

All intellectual property rights in or related to the Products including, but not limited to, patents, trade secrets, know-how, copyright, trademarks, service marks, and mask rights, registered or unregistered, owned or otherwise used by SAF, as well as all goodwill related thereto are and shall remain at all times the exclusive property of SAF. None of the foregoing property rights may be exploited by SAF's customers except as provided in these Terms nor shall such rights be transferred to SAF's customers except as expressly provided in these Terms. Each customer shall take reasonable measures to protect SAF's intellectual property rights.

SAF's and Aranet name and logo are proprietary trademarks and shall not be used without SAF's explicit permission. The customer shall further not alter or remove any proprietary marks, logos, or labels on SAF's Products.



!NOTE! Read carefully

It is responsibility of the user to enforce the country regulation and the specific environment regulation. Do not use this device if using the device is prohibited. Do not use the device if doing so causes danger or interference with other electronic devices.

Keep away from children, do not allow children or pets to bite or suck the device or accessories. Doing so may result in damage or explosion. Observe local laws and regulations and respect the privacy and legal rights of others.

Do not disassemble the product; any mark of tampering will compromise the warranty validity. We recommend following the instructions of this user guide for correct setup and use of the product.

5.5 DATA SECURITY

Aranet systems use encryption when the data is transmitted from the sensors to the base station. A unique encryption key is provided for each base station. The transmission protocol has built in safeguards against malicious operations (for example replay attacks).

Aranet sensors are protected from unauthorized data collection, therefore even if sensors are accessed the software used and the configuration parameters cannot be compromised.

To connect new sensors the user needs to be in proximity to the base station, therefore it is not possible to connect new sensors without authorization in order to compromise Aranet system by obtaining the encryption key.

5.6 CLEANING AND MAINTENANCE

Keep the device and accessories dry. Do not attempt to dry it with an external heat source, such as microwave oven or hair dryer.



Do not expose your device and accessories to extreme cold or heat. These environments may interfere with proper function and may lead to fire or explosion.

Avoid collision, which may lead to device malfunctions, overheating, fire, or explosion.

Please handle the product with care, avoiding any dropping and contact with the internal circuit board as electrostatic discharges may damage the product itself.

CAUTION: ARANET PRO BASE STATION CONTAIN AN ENCLOSED BATTERY. RISK OF DAMAGE IF

BATTERY IS REPLACED BY AN INCORRECT TYPE. DISPOSE OF USED BATTERIES

ACCORDING TO THE INSTRUCTIONS.

The user is responsible for disposal of the batteries according to the WEEE Directive Recast (Directive 2012/19/EU) and Battery Directive (Directive 2006/66/EC). Batteries should not be disposed of as household garbage. These items should not be disposed as of unsorted municipal waste and should be taken to a certified collection point for recycling or proper disposal.

5.7 ACCESSORIES

Use only power supplies which are provided by manufacturer and in the original packaging of this product.

Using unapproved or incompatible power adapter, charger or battery may cause fire, explosion or other hazards.

Choose only accessories approved for use with this model by the device manufacturer. The use of any other types of accessories may void the warranty, may violate local regulations and laws and may be dangerous. Please contact your retailer for information about the availability of approved accessories in your area.

5.8 DISCLAIMER

All contents of this manual are provided “as is”. Except as required by applicable laws, no warranties of any kind, either express or implied, including but not limited to, the implied warranties of merchantability and fitness for a particular purpose, are made in relation to the accuracy, reliability, or contents of this manual.

To the maximum extent permitted by applicable law, in no event shall SAF Tehnika JSC be liable for any special, incidental, indirect, or consequential damages, or loss of profits, business, revenue, data, goodwill savings or anticipated savings regardless of whether such losses are foreseeable or not.

5.9 ADDITIONAL INFORMATION

For additional information, please contact support@aranet.com



SAF Tehnika JSC

24a, Ganību Dambis Rīga,

LV-1005, Latvia

© 2017 - 2022 SAF Tehnika JSC. All rights reserved.