

TLC252, TLC252A, TLC252B, TLC252Y, TLC25L2, TLC25L2A, TLC25L2B TLC25L2Y, TLC25M2, TLC25M2A, TLC25M2B, TLC25M2Y LinCMOS™ DUAL OPERATIONAL AMPLIFIERS

SLOS0021 – JUNE 1983 – REVISED MARCH 2001

- A-Suffix Versions Offer 5-mV V_{IO}
- B-Suffix Versions Offer 2-mV V_{IO}
- Wide Range of Supply Voltages
1.4 V to 16 V
- True Single-Supply Operation
- Common-Mode Input Voltage Includes the Negative Rail
- Low Noise . . . 30 nV/ $\sqrt{\text{Hz}}$ Typ at $f = 1 \text{ kHz}$
(High-Bias Versions)

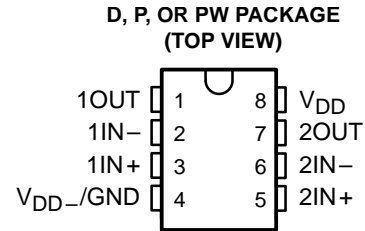

symbol (each amplifier)

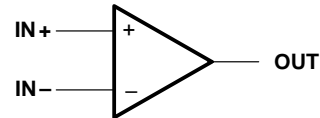

description

The TLC252, TLC25L2, and TLC25M2 are low-cost, low-power dual operational amplifiers designed to operate with single or dual supplies. These devices utilize the Texas Instruments silicon gate LinCMOS™ process, giving them stable input offset voltages that are available in selected grades of 2, 5, or 10 mV maximum, very high input impedances, and extremely low input offset and bias currents. Because the input common-mode range extends to the negative rail and the power consumption is extremely low, this series is ideally suited for battery-powered or energy-conserving applications. The series offers operation down to a 1.4-V supply, is stable at unity gain, and has excellent noise characteristics.

These devices have internal electrostatic-discharge (ESD) protection circuits that prevent catastrophic failures at voltages up to 2000 V as tested under MIL-STD-883C, Method 3015.1. However, care should be exercised in handling these devices as exposure to ESD may result in a degradation of the device parametric performance.

AVAILABLE OPTIONS

T _A	V _{IO} max AT 25°C	PACKAGED DEVICES			CHIP FORM (Y)
		SMALL OUTLINE (D)	PLASTIC DIP (P)	TSSOP (PW)	
0°C to 70°C	10 mV	TLC252CD	TLC252CP	TLC252CPW	TLC252Y
	5 mV	TLC252ACD	TLC252ACP	TLC252ACPW	—
	2 mV	TLC252BCD	TLC252BCP	TLC252BCPW	—
	10 mV	TLC25L2CD	TLC25L2CP	TLC25L2CPW	TLC25L2Y
	5 mV	TLC25L2ACD	TLC25L2ACP	TLC25L2ACPW	—
	2 mV	TLC25L2BCD	TLC25L2BCP	TLC25L2BCPW	—
	10 mV	TLC25M2CD	TLC25M2CP	—	TLC25M2Y
	5 mV	TLC25M2ACD	TLC25M2ACP	—	—
	2 mV	TLC25M2BCD	TLC25M2BCP	—	—

The D package is available taped and reeled. Add the suffix R to the device type (e.g., TLC252CDR). Chips are tested at 25°C.



Please be aware that an important notice concerning availability, standard warranty, and use in critical applications of Texas Instruments semiconductor products and disclaimers thereto appears at the end of this data sheet.

LinCMOS is a trademark of Texas Instruments.

PRODUCTION DATA information is current as of publication date. Products conform to specifications per the terms of Texas Instruments standard warranty. Production processing does not necessarily include testing of all parameters.

 **TEXAS
INSTRUMENTS**

POST OFFICE BOX 655303 • DALLAS, TEXAS 75265

Copyright © 2001, Texas Instruments Incorporated

TLC252, TLC252A, TLC252B, TLC252Y, TLC25L2, TLC25L2A, TLC25L2B TLC25L2Y, TLC25M2, TLC25M2A, TLC25M2B, TLC25M2Y LinCMOS™ DUAL OPERATIONAL AMPLIFIERS

SLOS002I – JUNE 1983 – REVISED MARCH 2001

description (continued)

Because of the extremely high input impedance and low input bias and offset currents, applications for the TLC252/25_2 series include many areas that have previously been limited to BIFET and NFET product types. Any circuit using high-impedance elements and requiring small offset errors is a good candidate for cost-effective use of these devices. Many features associated with bipolar technology are available with LinCMOS™ operational amplifiers without the power penalties of traditional bipolar devices. General applications such as transducer interfacing, analog calculations, amplifier blocks, active filters, and signal buffering are all easily designed with the TLC252/25_2 series devices. Remote and inaccessible equipment applications are possible using their low-voltage and low-power capabilities. The TLC252/25_2 series is well suited to solve the difficult problems associated with single-battery and solar-cell-powered applications. This series includes devices that are characterized for the commercial temperature range and are available in 8-pin plastic dip and the small-outline package. The device is also available in chip form.

The TLC252/25_2 series is characterized for operation from 0°C to 70°C.

equivalent schematic (each amplifier)

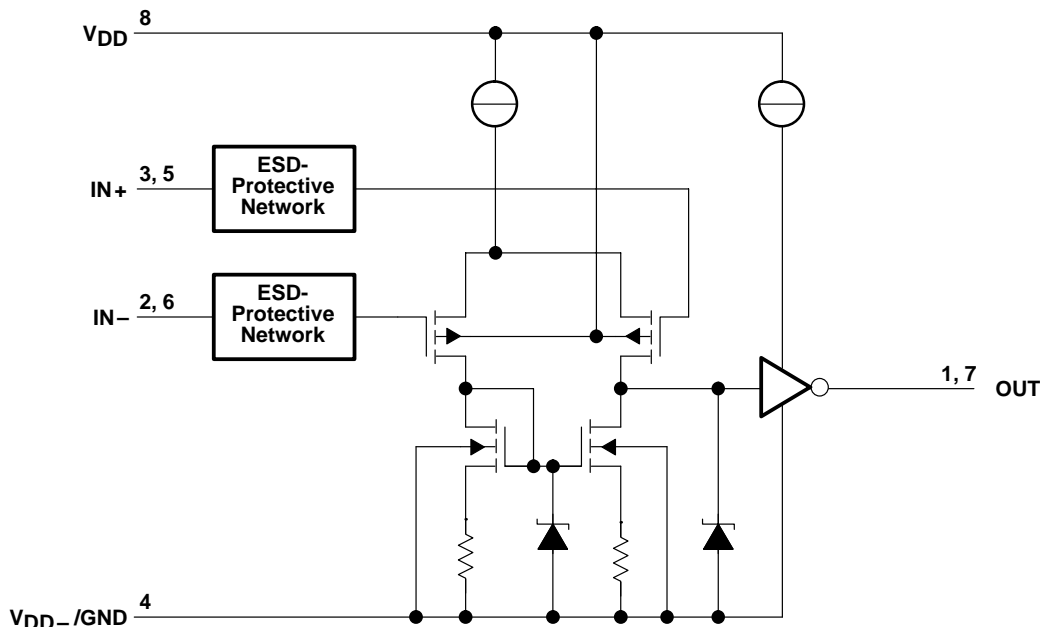

TLC252, TLC252A, TLC252B, TLC252Y, TLC25L2, TLC25L2A, TLC25L2B
 TLC25L2Y, TLC25M2, TLC25M2A, TLC25M2B, TLC25M2Y
 LinCMOS™ DUAL OPERATIONAL AMPLIFIERS

SLOS002I – JUNE 1983 – REVISED MARCH 2001

TLC252Y, TLC25L2Y, and TLC25M2Y chip information

These chips, properly assembled, display characteristics similar to the TLC252/25_2. Thermal compression or ultrasonic bonding may be used on the doped-aluminum bonding pads. Chips may be mounted with conductive epoxy or a gold-silicon preform.

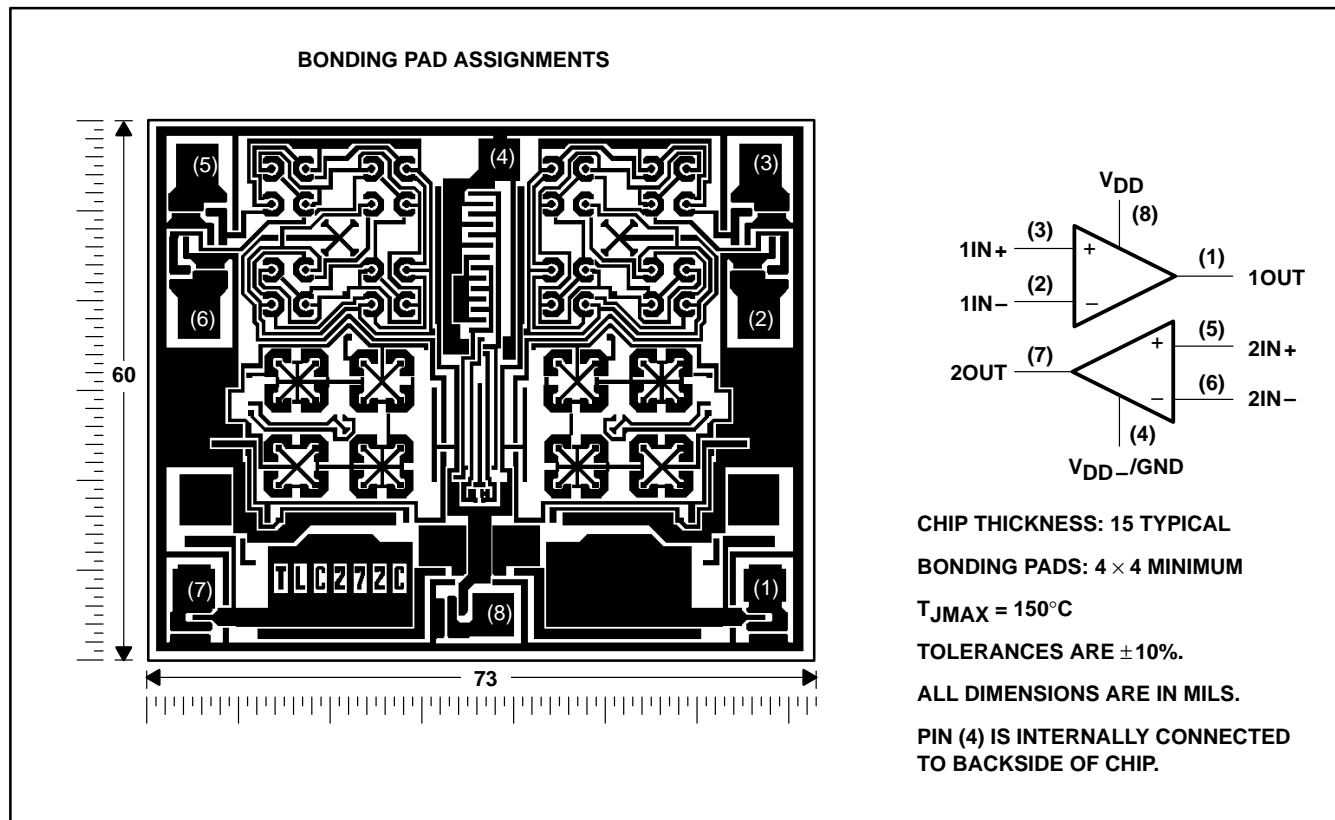

**TLC252, TLC252A, TLC252B, TLC252Y, TLC25L2, TLC25L2A, TLC25L2B
TLC25L2Y, TLC25M2, TLC25M2A, TLC25M2B, TLC25M2Y
LinCMOS™ DUAL OPERATIONAL AMPLIFIERS**

SLOS002I – JUNE 1983 – REVISED MARCH 2001

absolute maximum ratings over operating free-air temperature range (unless otherwise noted)†

Supply voltage, V_{DD} (see Note 1)	18 V
Differential input voltage, V_{ID} (see Note 2)	± 18 V
Input voltage range, V_I (any input)	-0.3 V to 18 V
Duration of short circuit at (or below) 25°C free-air temperature (see Note 3)	unlimited
Continuous total dissipation	See Dissipation Rating Table
Operating free-air temperature range, T_A	0°C to 70°C
Storage temperature range	-65°C to 150°C
Lead temperature 1,6 mm (1/16 inch) from case for 10 seconds	260°C

† Stresses beyond those listed under “absolute maximum ratings” may cause permanent damage to the device. These are stress ratings only, and functional operation of the device at these or any other conditions beyond those indicated under “recommended operating conditions” is not implied. Exposure to absolute-maximum-rated conditions for extended periods may affect device reliability.

- NOTES: 1. All voltage values, except differential voltages, are with respect to V_{DD-}/GND .
 2. Differential voltages are at $IN+$, with respect to $IN-$.
 3. The output may be shorted to either supply. Temperature and/or supply voltages must be limited to ensure the maximum dissipation rating is not exceeded.

DISSIPATION RATING TABLE

PACKAGE	$T_A \leq 25^\circ\text{C}$ POWER RATING	DERATING FACTOR ABOVE $T_A = 25^\circ\text{C}$	$T_A = 70^\circ\text{C}$ POWER RATING
D	725 mW	5.8 mW/°C	464 mW
P	1000 mW	8.0 mW/°C	640 mW
PW	525 mW	4.2 mW/°C	336 mW

recommended operating conditions

		MIN	MAX	UNIT
Supply voltage, V_{DD}		1.4	16	V
Common-mode input voltage, V_{IC}	$V_{DD} = 1.4$ V	0	0.2	V
	$V_{DD} = 5$ V	-0.2	4	
	$V_{DD} = 10$ V	-0.2	9	
	$V_{DD} = 16$ V	-0.2	14	
Operating free-air temperature, T_A		0	70	°C



**TLC252, TLC252A, TLC252B, TLC252Y, TLC25L2, TLC25L2A, TLC25L2B
TLC25L2Y, TLC25M2, TLC25M2A, TLC25M2B, TLC25M2Y
LinCMOS™ DUAL OPERATIONAL AMPLIFIERS**

SLOS002I – JUNE 1983 – REVISED MARCH 2001

electrical characteristics at specified free-air temperature, $V_{DD} = 1.4\text{ V}$ (unless otherwise noted)

PARAMETER		TEST CONDITIONS†	TLC252_C			TLC25L2_C			TLC25M2_C			UNIT	
			MIN	TYP	MAX	MIN	TYP	MAX	MIN	TYP	MAX		
V_{IO}	Input offset voltage	$V_O = 0.2\text{ V}$, $R_S = 50\ \Omega$	25°C	10			10			10			mV
			0°C to 70°C	12			12			12			
			25°C	5			5			5			
			0°C to 70°C	6.5			6.5			6.5			
			25°C	2			2			2			
			0°C to 70°C	3			3			3			
α_{VIO}	Average temperature coefficient of input offset voltage		25°C to 70°C	1			1			1			$\mu\text{V}/^\circ\text{C}$
I_{IO}	Input offset current	$V_O = 0.2\text{ V}$	25°C	1 60		1 60		1 60		1 60		pA	
			0°C to 70°C	300		300		300					
I_{IB}	Input bias current	$V_O = 0.2\text{ V}$	25°C	1 60		1 60		1 60		1 60		pA	
			0°C to 70°C	600		600		600					
V_{ICR}	Common-mode input voltage range		25°C	0 to 0.2		0 to 0.2		0 to 0.2		0 to 0.2		V	
V_{OM}	Peak output voltage swing‡	$V_{ID} = 100\text{ mV}$	25°C	450 700		450 700		450 700		450 700		mV	
A_{VD}	Large-signal differential voltage amplification	$V_O = 100\text{ to }300\text{ mV}$, $R_S = 50\ \Omega$	25°C	10		20		20		20		V/mV	
CMRR	Common-mode rejection ratio	$V_O = 0.2\text{ V}$, $V_{IC} = V_{ICRmin}$	25°C	60 77		60 77		60 77		60 77		dB	
I_{DD}	Supply current	$V_O = 0.2\text{ V}$, No load	25°C	300 375		25 34		200 250		200 250		μA	

† All characteristics are measured under open-loop conditions with zero common-mode input voltage unless otherwise specified. Unless otherwise noted, an output load resistor is connected from the output to ground and has the following value: for low bias $R_L = 1\text{ M}\Omega$, for medium bias $R_L = 100\text{ k}\Omega$, and for high bias $R_L = 10\text{ k}\Omega$.

‡ The output swings to the potential of V_{DD-}/GND .

operating characteristics, $V_{DD} = 1.4\text{ V}$, $T_A = 25^\circ\text{C}$

PARAMETER		TEST CONDITIONS	TLC252_C			TLC25L2_C			TLC25M2_C			UNIT
			MIN	TYP	MAX	MIN	TYP	MAX	MIN	TYP	MAX	
B_1	Unity-gain bandwidth	$A_V = 40\text{ dB}$, $C_L = 10\text{ pF}$, $R_S = 50\ \Omega$	12			12			12			kHz
SR	Slew rate at unity gain	See Figure 1	0.1			0.001			0.01			V/ μs
	Overshoot factor	See Figure 1	30%			35%			35%			



**TLC252, TLC252A, TLC252B, TLC252Y, TLC25L2, TLC25L2A, TLC25L2B
TLC25L2Y, TLC25M2, TLC25M2A, TLC25M2B, TLC25M2Y
LinCMOS™ DUAL OPERATIONAL AMPLIFIERS**

SLOS002I – JUNE 1983 – REVISED MARCH 2001

electrical characteristics at specified free-air temperature, $V_{DD} = 5\text{ V}$ (unless otherwise noted)

PARAMETER		TEST CONDITIONS	T_A †	TLC252C, TLC252AC, TLC252BC			UNIT
				MIN	TYP	MAX	
V_{IO}	Input offset voltage	TLC252C	$V_O = 1.4\text{ V},$ $R_S = 50\ \Omega,$ $V_{IC} = 0,$ $R_L = 10\text{ k}\Omega$	25°C	1.1	10	mV
				Full range		12	
		TLC252AC	$V_O = 1.4\text{ V},$ $R_S = 50\ \Omega,$ $V_{IC} = 0,$ $R_L = 10\text{ k}\Omega$	25°C	0.9	5	
				Full range		6.5	
		TLC252BC	$V_O = 1.4\text{ V},$ $R_S = 50\ \Omega,$ $V_{IC} = 0,$ $R_L = 10\text{ k}\Omega$	25°C	0.23	2	
				Full range		3	
α_{VIO}	Average temperature coefficient of input offset voltage		25°C to 70°C	1.8		$\mu\text{V}/^\circ\text{C}$	
I_{IO}	Input offset current (see Note 4)	$V_O = 2.5\text{ V},$ $V_{IC} = 2.5\text{ V}$	25°C	0.1	60	pA	
			70°C	7	300		
I_{IB}	Input bias current (see Note 4)	$V_O = 2.5\text{ V},$ $V_{IC} = 2.5\text{ V}$	25°C	0.6	60	pA	
			70°C	40	600		
V_{ICR}	Common-mode input voltage range (see Note 5)		25°C	-0.2 to 4	-0.3 to 4.2	V	
			Full range	-0.2 to 3.5		V	
V_{OH}	High-level output voltage	$V_{ID} = 100\text{ mV},$ $R_L = 10\text{ k}\Omega$	25°C	3.2	3.8	V	
			0°C	3	3.8		
			70°C	3	3.8		
V_{OL}	Low-level output voltage	$V_{ID} = -100\text{ mV},$ $I_{OL} = 0$	25°C	0	50	mV	
			0°C	0	50		
			70°C	0	50		
A_{VD}	Large-signal differential voltage amplification	$V_O = 0.25\text{ V to } 2\text{ V},$ $R_L = 10\text{ k}\Omega$	25°C	5	23	V/mV	
			0°C	4	27		
			70°C	4	20		
CMRR	Common-mode rejection ratio	$V_{IC} = V_{ICRmin}$	25°C	65	80	dB	
			0°C	60	84		
			70°C	60	85		
k_{SVR}	Supply-voltage rejection ratio ($\Delta V_{DD}/\Delta V_{DD}$)	$V_{DD} = 5\text{ V to } 10\text{ V},$ $V_O = 1.4\text{ V}$	25°C	65	95	dB	
			0°C	60	94		
			70°C	60	96		
I_{DD}	Supply current (two amplifiers)	$V_O = 2.5\text{ V},$ No load $V_{IC} = 2.5\text{ V},$	25°C	1.4	3.2	mA	
			0°C	1.6	3.6		
			70°C	1.2	2.6		

† Full range is 0°C to 70°C.

NOTES: 4. The typical values of input bias current and input offset current below 5 pA were determined mathematically.

5. This range also applies to each input individually.



**TLC252, TLC252A, TLC252B, TLC252Y, TLC25L2, TLC25L2A, TLC25L2B
TLC25L2Y, TLC25M2, TLC25M2A, TLC25M2B, TLC25M2Y
LinCMOS™ DUAL OPERATIONAL AMPLIFIERS**

SLOS002I – JUNE 1983 – REVISED MARCH 2001

electrical characteristics at specified free-air temperature, $V_{DD} = 10\text{ V}$ (unless otherwise noted)

PARAMETER		TEST CONDITIONS		T_A †	TLC252C, TLC252AC, TLC252BC			UNIT
					MIN	TYP	MAX	
V_{IO}	Input offset voltage	TLC252C	$V_O = 1.4\text{ V}$, $R_S = 50\ \Omega$	$V_{IC} = 0$, $R_L = 10\text{ k}\Omega$	25°C	1.1	10	mV
					Full range		12	
		TLC252AC	$V_O = 1.4\text{ V}$, $R_S = 50\ \Omega$	$V_{IC} = 0$, $R_L = 10\text{ k}\Omega$	25°C	0.9	5	
					Full range		6.5	
		TLC252BC	$V_O = 1.4\text{ V}$, $R_S = 50\ \Omega$	$V_{IC} = 0$, $R_L = 10\text{ k}\Omega$	25°C	0.29	2	
					Full range		3	
α_{VIO}	Average temperature coefficient of input offset voltage			25°C to 70°C	2		$\mu\text{V}/^\circ\text{C}$	
I_{IO}	Input offset current (see Note 4)	$V_O = 2.5\text{ V}$	$V_{IC} = 2.5\text{ V}$	25°C	0.1	60	pA	
				70°C	7	300		
I_{IB}	Input bias current (see Note 4)	$V_O = 2.5\text{ V}$	$V_{IC} = 2.5\text{ V}$	25°C	0.6	60	pA	
				70°C	50	600		
V_{ICR}	Common-mode input voltage range (see Note 5)			25°C	-0.2 to 9	-0.3 to 9.2	V	
				Full range	-0.2 to 8.5		V	
V_{OH}	High-level output voltage	$V_{ID} = 100\text{ mV}$	$R_L = 10\text{ k}\Omega$	25°C	8	8.5	V	
				0°C	8	8.5		
				70°C	7.8	8.4		
V_{OL}	Low-level output voltage	$V_{ID} = -100\text{ mV}$	$I_{OL} = 0$	25°C	0	50	mV	
				0°C	0	50		
				70°C	0	50		
A_{VD}	Large-signal differential voltage amplification	$V_O = 1\text{ V to }6\text{ V}$	$R_L = 10\text{ k}\Omega$	25°C	10	36	V/mV	
				0°C	7.5	42		
				70°C	7.5	32		
CMRR	Common-mode rejection ratio	$V_{IC} = V_{ICRmin}$		25°C	65	85	dB	
				0°C	60	88		
				70°C	60	88		
k_{SVR}	Supply-voltage rejection ratio ($\Delta V_{DD}/\Delta V_{DD}$)	$V_{DD} = 5\text{ V to }10\text{ V}$	$V_O = 1.4\text{ V}$	25°C	65	95	dB	
				0°C	60	94		
				70°C	60	96		
I_{DD}	Supply current (two amplifiers)	$V_O = 5\text{ V}$, No load	$V_{IC} = 5\text{ V}$	25°C	1.9	4	mA	
				0°C	2.3	4.4		
				70°C	1.6	3.4		

† Full range is 0°C to 70°C.

- NOTES: 4. The typical values of input bias current and input offset current below 5 pA were determined mathematically.
5. This range also applies to each input individually.



**TLC252, TLC252A, TLC252B, TLC252Y, TLC25L2, TLC25L2A, TLC25L2B
TLC25L2Y, TLC25M2, TLC25M2A, TLC25M2B, TLC25M2Y
LinCMOS™ DUAL OPERATIONAL AMPLIFIERS**

SLOS002I – JUNE 1983 – REVISED MARCH 2001

operating characteristics, $V_{DD} = 5\text{ V}$

PARAMETER	TEST CONDITIONS	T_A	TLC252C, TLC252AC, TLC252BC			UNIT
			MIN	TYP	MAX	
SR Slew rate at unity gain	$R_L = 10\text{ k}\Omega$, See Figure 1 $C_L = 20\text{ pF}$	$V_{I(PP)} = 1\text{ V}$	25°C	3.6		V/ μ s
			0°C	4		
			70°C	3		
		$V_{I(PP)} = 2.5\text{ V}$	25°C	2.9		
			0°C	3.1		
			70°C	2.5		
V_n Equivalent input noise voltage	$f = 1\text{ kHz}$, $R_S = 20\ \Omega$, See Figure 2	25°C	25		nV/ $\sqrt{\text{Hz}}$	
B_{OM} Maximum output-swing bandwidth	$V_O = V_{OH}$, See Figure 1 $C_L = 20\text{ pF}$, $R_L = 100\text{ k}\Omega$	25°C	320		kHz	
		0°C	340			
		70°C	260			
B_1 Unity-gain bandwidth	$V_I = 10\text{ mV}$, $C_L = 20\text{ pF}$, See Figure 3	25°C	1.7		MHz	
		0°C	2			
		70°C	1.3			
ϕ_m Phase margin	$V_I = 10\text{ mV}$, See Figure 3 $f = B_1$, $C_L = 20\text{ pF}$	25°C	46°			
		0°C	47°			
		70°C	43°			

operating characteristics, $V_{DD} = 10\text{ V}$

PARAMETER	TEST CONDITIONS	T_A	TLC252C, TLC252AC, TLC252BC			UNIT
			MIN	TYP	MAX	
SR Slew rate at unity gain	$R_L = 10\text{ k}\Omega$, See Figure 1 $C_L = 20\text{ pF}$	$V_{I(PP)} = 1\text{ V}$	25°C	5.3		V/ μ s
			0°C	5.9		
			70°C	4.3		
		$V_{I(PP)} = 5.5\text{ V}$	25°C	4.6		
			0°C	5.1		
			70°C	3.8		
V_n Equivalent input noise voltage	$f = 1\text{ kHz}$, $R_S = 20\ \Omega$, See Figure 2	25°C	25		nV/ $\sqrt{\text{Hz}}$	
B_{OM} Maximum output-swing bandwidth	$V_O = V_{OH}$, See Figure 1 $C_L = 20\text{ pF}$, $R_L = 100\text{ k}\Omega$	25°C	200		kHz	
		0°C	220			
		70°C	140			
B_1 Unity-gain bandwidth	$V_I = 10\text{ mV}$, $C_L = 20\text{ pF}$, See Figure 3	25°C	2.2		MHz	
		0°C	2.5			
		70°C	1.8			
ϕ_m Phase margin	$V_I = 10\text{ mV}$, See Figure 3 $f = B_1$, $C_L = 20\text{ pF}$	25°C	49°			
		0°C	50°			
		70°C	46°			



**TLC252, TLC252A, TLC252B, TLC252Y, TLC25L2, TLC25L2A, TLC25L2B
TLC25L2Y, TLC25M2, TLC25M2A, TLC25M2B, TLC25M2Y
LinCMOS™ DUAL OPERATIONAL AMPLIFIERS**

SLOS002I – JUNE 1983 – REVISED MARCH 2001

electrical characteristics at specified free-air temperature, $V_{DD} = 5\text{ V}$ (unless otherwise noted)

PARAMETER		TEST CONDITIONS	T_A †	TLC25L2C TLC25L2AC TLC25L2BC			UNIT
				MIN	TYP	MAX	
V_{IO}	Input offset voltage	TLC252C $V_O = 1.4\text{ V}$, $R_S = 50\ \Omega$, $V_{IC} = 0$, $R_L = 1\text{ M}\Omega$	25°C	1.1	10	mV	
			Full range		12		
		TLC252AC $V_O = 1.4\text{ V}$, $R_S = 50\ \Omega$, $V_{IC} = 0$, $R_L = 1\text{ M}\Omega$	25°C	0.9	5		
			Full range		6.5		
		TLC252BC $V_O = 1.4\text{ V}$, $R_S = 50\ \Omega$, $V_{IC} = 0$, $R_L = 1\text{ M}\Omega$	25°C	0.204	2		
			Full range		3		
α_{VIO}	Average temperature coefficient of input offset voltage		25°C to 70°C	1.1		$\mu\text{V}/^\circ\text{C}$	
I_{IO}	Input offset current (see Note 4)	$V_O = 2.5\text{ V}$, $V_{IC} = 2.5\text{ V}$	25°C	0.1	60	pA	
			70°C	7	300		
I_{IB}	Input bias current (see Note 4)	$V_O = 2.5\text{ V}$, $V_{IC} = 2.5\text{ V}$	25°C	0.6	60	pA	
			70°C	50	600		
V_{ICR}	Common-mode input voltage range (see Note 5)		25°C	-0.2 to 4	-0.3 to 4.2	V	
			Full range	-0.2 to 3.5		V	
V_{OH}	High-level output voltage	$V_{ID} = 100\text{ mV}$, $R_L = 1\text{ M}\Omega$	25°C	3.2	4.1	V	
			0°C	3	4.1		
			70°C	3	4.2		
V_{OL}	Low-level output voltage	$V_{ID} = -100\text{ mV}$, $I_{OL} = 0$	25°C	0	50	mV	
			0°C	0	50		
			70°C	0	50		
A_{VD}	Large-signal differential voltage amplification	$V_O = 0.25\text{ V to }2\text{ V}$, $R_L = 1\text{ M}\Omega$	25°C	50	700	V/mV	
			0°C	50	700		
			70°C	50	380		
CMRR	Common-mode rejection ratio	$V_{IC} = V_{ICRmin}$	25°C	65	94	dB	
			0°C	60	95		
			70°C	60	95		
k_{SVR}	Supply-voltage rejection ratio ($\Delta V_{DD}/\Delta V_{DD}$)	$V_{DD} = 5\text{ V to }10\text{ V}$, $V_O = 1.4\text{ V}$	25°C	70	97	dB	
			0°C	60	97		
			70°C	60	98		
I_{DD}	Supply current (two amplifiers)	$V_O = 2.5\text{ V}$, No load $V_{IC} = 2.5\text{ V}$	25°C	20	34	μA	
			0°C	24	42		
			70°C	16	28		

† Full range is 0°C to 70°C.

- NOTES: 4. The typical values of input bias current and input offset current below 5 pA were determined mathematically.
5. This range also applies to each input individually.



**TLC252, TLC252A, TLC252B, TLC252Y, TLC25L2, TLC25L2A, TLC25L2B
TLC25L2Y, TLC25M2, TLC25M2A, TLC25M2B, TLC25M2Y
LinCMOS™ DUAL OPERATIONAL AMPLIFIERS**

SLOS002I – JUNE 1983 – REVISED MARCH 2001

electrical characteristics at specified free-air temperature, $V_{DD} = 10\text{ V}$ (unless otherwise noted)

PARAMETER		TEST CONDITIONS	T_A †	TLC25L2C TLC25L2AC TLC25L2BC			UNIT
				MIN	TYP	MAX	
V_{IO}	Input offset voltage	TLC252C $V_O = 1.4\text{ V}$, $R_S = 50\ \Omega$, $V_{IC} = 0$, $R_L = 1\text{ M}\Omega$	25°C	1.1	10	mV	
			Full range		12		
		TLC252AC $V_O = 1.4\text{ V}$, $R_S = 50\ \Omega$, $V_{IC} = 0$, $R_L = 1\text{ M}\Omega$	25°C	0.9	5		
			Full range		6.5		
		TLC252BC $V_O = 1.4\text{ V}$, $R_S = 50\ \Omega$, $V_{IC} = 0$, $R_L = 1\text{ M}\Omega$	25°C	0.235	2		
			Full range		3		
α_{VIO}	Average temperature coefficient of input offset voltage		25°C to 70°C	1		$\mu\text{V}/^\circ\text{C}$	
I_{IO}	Input offset current (see Note 4)	$V_O = 5\text{ V}$, $V_{IC} = 5\text{ V}$	25°C	0.1	60	pA	
			70°C	8	300		
I_{IB}	Input bias current (see Note 4)	$V_O = 5\text{ V}$, $V_{IC} = 5\text{ V}$	25°C	0.7	60	pA	
			70°C	50	600		
V_{ICR}	Common-mode input voltage range (see Note 5)		25°C	-0.2 to 9	-0.3 to 9.2	V	
			Full range	-0.2 to 8.5		V	
V_{OH}	High-level output voltage	$V_{ID} = 100\text{ mV}$, $R_L = 1\text{ M}\Omega$	25°C	8	8.9	V	
			0°C	7.8	8.9		
			70°C	7.8	8.9		
V_{OL}	Low-level output voltage	$V_{ID} = -100\text{ mV}$, $I_{OL} = 0$	25°C	0	50	mV	
			0°C	0	50		
			70°C	0	50		
A_{VD}	Large-signal differential voltage amplification	$V_O = 1\text{ V to }6\text{ V}$, $R_L = 1\text{ M}\Omega$	25°C	50	860	V/mV	
			0°C	50	1025		
			70°C	50	660		
CMRR	Common-mode rejection ratio	$V_{IC} = V_{ICRmin}$	25°C	65	97	dB	
			0°C	60	97		
			70°C	60	97		
k_{SVR}	Supply-voltage rejection ratio ($\Delta V_{DD}/\Delta V_{DD}$)	$V_{DD} = 5\text{ V to }10\text{ V}$, $V_O = 1.4\text{ V}$	25°C	70	97	dB	
			0°C	60	97		
			70°C	60	98		
I_{DD}	Supply current (two amplifiers)	$V_O = 5\text{ V}$, No load $V_{IC} = 5\text{ V}$	25°C	29	46	μA	
			0°C	36	66		
			70°C	22	40		

† Full range is 0°C to 70°C.

NOTES: 4. The typical values of input bias current and input offset current below 5 pA were determined mathematically.

5. This range also applies to each input individually.



**TLC252, TLC252A, TLC252B, TLC252Y, TLC25L2, TLC25L2A, TLC25L2B
TLC25L2Y, TLC25M2, TLC25M2A, TLC25M2B, TLC25M2Y
LinCMOS™ DUAL OPERATIONAL AMPLIFIERS**

SLOS0021 – JUNE 1983 – REVISED MARCH 2001

operating characteristics, $V_{DD} = 5\text{ V}$

PARAMETER	TEST CONDITIONS	T_A	TLC25L2C TLC25L2AC TLC25L2BC			UNIT
			MIN	TYP	MAX	
SR Slew rate at unity gain	$R_L = 1\text{ M}\Omega$, $C_L = 20\text{ pF}$, See Figure 1	$V_{I(PP)} = 1\text{ V}$	25°C	0.03		V/ μ s
			0°C	0.04		
			70°C	0.03		
		$V_{I(PP)} = 2.5\text{ V}$	25°C	0.03		
			0°C	0.03		
			70°C	0.02		
V_n Equivalent input noise voltage	$f = 1\text{ kHz}$, $R_S = 20\ \Omega$, See Figure 2	25°C	68		nV/ $\sqrt{\text{Hz}}$	
B_{OM} Maximum output-swing bandwidth	$V_O = V_{OH}$, $C_L = 20\text{ pF}$, See Figure 1	$R_L = 1\text{ M}\Omega$	25°C	5		kHz
			0°C	6		
			70°C	4.5		
B_1 Unity-gain bandwidth	$V_I = 10\text{ mV}$, $C_L = 20\text{ pF}$, See Figure 3	See Figure 3	25°C	85		MHz
			0°C	100		
			70°C	65		
ϕ_m Phase margin	$V_I = 10\text{ mV}$, $f = B_1$, See Figure 3	$C_L = 20\text{ pF}$	25°C	34°		
			0°C	36°		
			70°C	30°		

operating characteristics, $V_{DD} = 10\text{ V}$

PARAMETER	TEST CONDITIONS	T_A	TLC25L2C TLC25L2AC TLC25L2BC			UNIT
			MIN	TYP	MAX	
SR Slew rate at unity gain	$R_L = 1\text{ M}\Omega$, $C_L = 20\text{ pF}$, See Figure 1	$V_{I(PP)} = 1\text{ V}$	25°C	0.05		V/ μ s
			0°C	0.05		
			70°C	0.04		
		$V_{I(PP)} = 5.5\text{ V}$	25°C	0.04		
			0°C	0.05		
			70°C	0.04		
V_n Equivalent input noise voltage	$f = 1\text{ kHz}$, $R_S = 20\ \Omega$, See Figure 2	25°C	68		nV/ $\sqrt{\text{Hz}}$	
B_{OM} Maximum output-swing bandwidth	$V_O = V_{OH}$, $C_L = 20\text{ pF}$, See Figure 1	$R_L = 1\text{ M}\Omega$	25°C	1		kHz
			0°C	1.3		
			70°C	0.9		
B_1 Unity-gain bandwidth	$V_I = 10\text{ mV}$, $C_L = 20\text{ pF}$, See Figure 3	See Figure 3	25°C	110		MHz
			0°C	125		
			70°C	90		
ϕ_m Phase margin	$V_I = 10\text{ mV}$, $f = B_1$, See Figure 3	$C_L = 20\text{ pF}$	25°C	38°		
			0°C	40°		
			70°C	34°		



**TLC252, TLC252A, TLC252B, TLC252Y, TLC25L2, TLC25L2A, TLC25L2B
TLC25L2Y, TLC25M2, TLC25M2A, TLC25M2B, TLC25M2Y
LinCMOS™ DUAL OPERATIONAL AMPLIFIERS**

SLOS002I – JUNE 1983 – REVISED MARCH 2001

electrical characteristics at specified free-air temperature, $V_{DD} = 5\text{ V}$ (unless otherwise noted)

PARAMETER		TEST CONDITIONS	T_A^\dagger	TLC25M2C TLC25M2AC TLC25M2BC			UNIT
				MIN	TYP	MAX	
V_{IO}	Input offset voltage	TLC252C $V_O = 1.4\text{ V}$, $R_S = 50\ \Omega$, $V_{IC} = 0$, $R_L = 100\text{ k}\Omega$	25°C	1.1	10	mV	
			Full range		12		
		TLC252AC $V_O = 1.4\text{ V}$, $R_S = 50\ \Omega$, $V_{IC} = 0$, $R_L = 100\text{ k}\Omega$	25°C	0.9	5		
			Full range		6.5		
		TLC252BC $V_O = 1.4\text{ V}$, $R_S = 50\ \Omega$, $V_{IC} = 0$, $R_L = 100\text{ k}\Omega$	25°C	0.22	2		
			Full range		3		
α_{VIO}	Average temperature coefficient of input offset voltage		25°C to 70°C	1.7		$\mu\text{V}/^\circ\text{C}$	
I_{IO}	Input offset current (see Note 4)	$V_O = 2.5\text{ V}$, $V_{IC} = 2.5\text{ V}$	25°C	0.1	60	pA	
			70°C	7	300		
I_{IB}	Input bias current (see Note 4)	$V_O = 2.5\text{ V}$, $V_{IC} = 2.5\text{ V}$	25°C	0.6	60	pA	
			70°C	40	600		
V_{ICR}	Common-mode input voltage range (see Note 5)		25°C	-0.2 to 4	-0.3 to 4.2	V	
			Full range	-0.2 to 3.5		V	
V_{OH}	High-level output voltage	$V_{ID} = 100\text{ mV}$, $R_L = 100\text{ k}\Omega$	25°C	3.2	3.9	V	
			0°C	3	3.9		
			70°C	3	4		
V_{OL}	Low-level output voltage	$V_{ID} = -100\text{ mV}$, $I_{OL} = 0$	25°C	0	50	mV	
			0°C	0	50		
			70°C	0	50		
A_{VD}	Large-signal differential voltage amplification	$V_O = 0.25\text{ V to }2\text{ V}$, $R_L = 100\text{ k}\Omega$	25°C	25	170	V/mV	
			0°C	15	200		
			70°C	15	140		
CMRR	Common-mode rejection ratio	$V_{IC} = V_{ICRmin}$	25°C	65	91	dB	
			0°C	60	91		
			70°C	60	92		
k_{SVR}	Supply-voltage rejection ratio ($\Delta V_{DD}/\Delta V_{DD}$)	$V_{DD} = 5\text{ V to }10\text{ V}$, $V_O = 1.4\text{ V}$	25°C	70	93	dB	
			0°C	60	92		
			70°C	60	94		
I_{DD}	Supply current (two amplifiers)	$V_O = 2.5\text{ V}$, No load $V_{IC} = 2.5\text{ V}$	25°C	210	560	μA	
			0°C	250	640		
			70°C	170	440		

† Full range is 0°C to 70°C.

NOTES: 4. The typical values of input bias current and input offset current below 5 pA were determined mathematically.

5. This range also applies to each input individually.



**TLC252, TLC252A, TLC252B, TLC252Y, TLC25L2, TLC25L2A, TLC25L2B
TLC25L2Y, TLC25M2, TLC25M2A, TLC25M2B, TLC25M2Y
LinCMOS™ DUAL OPERATIONAL AMPLIFIERS**

SLOS002I – JUNE 1983 – REVISED MARCH 2001

electrical characteristics at specified free-air temperature, $V_{DD} = 10\text{ V}$ (unless otherwise noted)

PARAMETER		TEST CONDITIONS	T_A †	TLC25M2C TLC25M2AC TLC25M2BC			UNIT
				MIN	TYP	MAX	
V_{IO}	Input offset voltage	TLC252C $V_O = 1.4\text{ V}$, $R_S = 50\ \Omega$, $V_{IC} = 0$, $R_L = 100\text{ k}\Omega$	25°C	1.1	10	mV	
			Full range		12		
		TLC252AC $V_O = 1.4\text{ V}$, $R_S = 50\ \Omega$, $V_{IC} = 0$, $R_L = 100\text{ k}\Omega$	25°C	0.9	5		
			Full range		6.5		
		TLC252BC $V_O = 1.4\text{ V}$, $R_S = 50\ \Omega$, $V_{IC} = 0$, $R_L = 100\text{ k}\Omega$	25°C	0.224	2		
			Full range		3		
α_{VIO}	Average temperature coefficient of input offset voltage		25°C to 70°C	2.1		$\mu\text{V}/^\circ\text{C}$	
I_{IO}	Input offset current (see Note 4)	$V_O = 5\text{ V}$, $V_{IC} = 5\text{ V}$	25°C	0.1	60	pA	
			70°C	7	300		
I_{IB}	Input bias current (see Note 4)	$V_O = 5\text{ V}$, $V_{IC} = 5\text{ V}$	25°C	0.7	60	pA	
			70°C	50	600		
V_{ICR}	Common-mode input voltage range (see Note 5)		25°C	-0.2 to 9	-0.3 to 9.2	V	
			Full range	-0.2 to 8.5		V	
V_{OH}	High-level output voltage	$V_{ID} = 100\text{ mV}$, $R_L = 100\text{ k}\Omega$	25°C	8	8.7	V	
			0°C	7.8	8.7		
			70°C	7.8	8.7		
V_{OL}	Low-level output voltage	$V_{ID} = -100\text{ mV}$, $I_{OL} = 0$	25°C	0	50	mV	
			0°C	0	50		
			70°C	0	50		
A_{VD}	Large-signal differential voltage amplification	$V_O = 1\text{ V to }6\text{ V}$, $R_L = 100\text{ k}\Omega$	25°C	25	275	V/mV	
			0°C	15	320		
			70°C	15	230		
CMRR	Common-mode rejection ratio	$V_{IC} = V_{ICRmin}$	25°C	65	94	dB	
			0°C	60	94		
			70°C	60	94		
k_{SVR}	Supply-voltage rejection ratio ($\Delta V_{DD}/\Delta V_{DD}$)	$V_{DD} = 5\text{ V to }10\text{ V}$, $V_O = 1.4\text{ V}$	25°C	70	93	dB	
			0°C	60	92		
			70°C	60	94		
I_{DD}	Supply current (two amplifiers)	$V_O = 5\text{ V}$, No load $V_{IC} = 5\text{ V}$	25°C	285	600	μA	
			0°C	345	800		
			70°C	220	560		

† Full range is 0°C to 70°C.

- NOTES: 4. The typical values of input bias current and input offset current below 5 pA were determined mathematically.
5. This range also applies to each input individually.



**TLC252, TLC252A, TLC252B, TLC252Y, TLC25L2, TLC25L2A, TLC25L2B
TLC25L2Y, TLC25M2, TLC25M2A, TLC25M2B, TLC25M2Y
LinCMOS™ DUAL OPERATIONAL AMPLIFIERS**

SLOS002I – JUNE 1983 – REVISED MARCH 2001

operating characteristics, $V_{DD} = 5\text{ V}$

PARAMETER	TEST CONDITIONS	T_A	TLC25M2C TLC25M2AC TLC25M2BC			UNIT
			MIN	TYP	MAX	
SR Slew rate at unity gain	$R_L = 100\text{ k}\Omega$, $C_L = 20\text{ pF}$, See Figure 1	$V_{I(PP)} = 1\text{ V}$	25°C	0.43		V/ μs
			0°C	0.46		
			70°C	0.36		
		$V_{I(PP)} = 2.5\text{ V}$	25°C	0.40		
			0°C	0.43		
			70°C	0.34		
V_n Equivalent input noise voltage	$f = 1\text{ kHz}$, $R_S = 20\ \Omega$, See Figure 2	25°C	32		nV/ $\sqrt{\text{Hz}}$	
B_{OM} Maximum output-swing bandwidth	$V_O = V_{OH}$, $C_L = 20\text{ pF}$, See Figure 1	$R_L = 100\text{ k}\Omega$	25°C	55		kHz
			0°C	60		
			70°C	50		
B_1 Unity-gain bandwidth	$V_I = 10\text{ mV}$, $C_L = 20\text{ pF}$, See Figure 3	See Figure 3	25°C	525		MHz
			0°C	600		
			70°C	400		
ϕ_m Phase margin	$V_I = 10\text{ mV}$, See Figure 3	$f = B_1$, $C_L = 20\text{ pF}$	25°C	40°		
			0°C	41°		
			70°C	39°		

operating characteristics, $V_{DD} = 10\text{ V}$

PARAMETER	TEST CONDITIONS	T_A	TLC25M2C TLC25M2AC TLC25M2BC			UNIT
			MIN	TYP	MAX	
SR Slew rate at unity gain	$R_L = 100\text{ k}\Omega$, $C_L = 20\text{ pF}$, See Figure 1	$V_{I(PP)} = 1\text{ V}$	25°C	0.62		V/ μs
			0°C	0.67		
			70°C	0.51		
		$V_{I(PP)} = 5.5\text{ V}$	25°C	0.56		
			0°C	0.61		
			70°C	0.46		
V_n Equivalent input noise voltage	$f = 1\text{ kHz}$, $R_S = 20\ \Omega$, See Figure 2	25°C	32		nV/ $\sqrt{\text{Hz}}$	
B_{OM} Maximum output-swing bandwidth	$V_O = V_{OH}$, $C_L = 20\text{ pF}$, See Figure 1	$R_L = 100\text{ k}\Omega$	25°C	35		kHz
			0°C	40		
			70°C	30		
B_1 Unity-gain bandwidth	$V_I = 10\text{ mV}$, $C_L = 20\text{ pF}$, See Figure 3	See Figure 3	25°C	635		MHz
			0°C	710		
			70°C	510		
ϕ_m Phase margin	$V_I = 10\text{ mV}$, See Figure 3	$f = B_1$, $C_L = 20\text{ pF}$	25°C	43°		
			0°C	44°		
			70°C	42°		



**TLC252, TLC252A, TLC252B, TLC252Y, TLC25L2, TLC25L2A, TLC25L2B
TLC25L2Y, TLC25M2, TLC25M2A, TLC25M2B, TLC25M2Y
LinCMOS™ DUAL OPERATIONAL AMPLIFIERS**

SLOS002I – JUNE 1983 – REVISED MARCH 2001

electrical characteristics, $V_{DD} = 5\text{ V}$, $T_A = 25^\circ\text{C}$

PARAMETER	TEST CONDITIONS	TLC252Y			TLC25L2Y			TLC25M2Y			UNIT
		MIN	TYP	MAX	MIN	TYP	MAX	MIN	TYP	MAX	
V_{IO}	Input offset voltage $V_O = 1.4\text{ V}$, $V_{IC} = 0\text{ V}$, $R_S = 50\ \Omega$, See Note 6		1.1	10		1.1	10		1.1	10	mV
α_{VIO}	Average temperature coefficient of input offset voltage		1.8			1.1			1.7		$\mu\text{V}/^\circ\text{C}$
I_{IO}	Input offset current (see Note 4) $V_O = V_{DD}/2$, $V_{IC} = V_{DD}/2$		0.1	60		0.1	60		0.1	60	pA
I_{IB}	Input bias current (see Note 4) $V_O = V_{DD}/2$, $V_{IC} = V_{DD}/2$		0.6	60		0.6	60		0.6	60	pA
V_{ICR}	Common-mode input voltage range (see Note 5)	-0.2 to 4	-0.3 to 4.2		-0.2 to 4	-0.3 to 4.2		-0.2 to 4	-0.3 to 4.2		V
V_{OH}	High-level output voltage $V_{ID} = 100\text{ mV}$, See Note 6	3.2	3.8		3.2	4.1		3.2	3.9		V
V_{OL}	Low-level output voltage $V_{ID} = -100\text{ mV}$, $I_{OL} = 0$		0	50		0	50		0	50	mV
A_{VD}	Large-signal differential voltage amplification $V_O = 0.25\text{ V}$, See Note 6	5	23		50	700		25	170		V/mV
CMRR	Common-mode rejection ratio $V_{IC} = V_{ICRmin}$	65	80		65	94		65	91		dB
k_{SVR}	Supply-voltage rejection ratio ($\Delta V_{DD}/\Delta V_{IO}$) $V_{DD} = 5\text{ V}$ to 10 V , $V_O = 1.4\text{ V}$	65	95		70	97		70	93		dB
I_{DD}	Supply current $V_O = V_{DD}/2$, $V_{IC} = V_{DD}/2$, No load		1.4	3.2		0.02	0.034		0.21	0.56	mA

operating characteristics, $V_{DD} = 5\text{ V}$, $T_A = 25^\circ\text{C}$

PARAMETER	TEST CONDITIONS		TLC252Y			TLC25L2Y			TLC25M2Y			UNIT
			MIN	TYP	MAX	MIN	TYP	MAX	MIN	TYP	MAX	
Slew rate at unity gain	$C_L = 20\text{ pF}$, See Note 6	$V_{I(PP)} = 1\text{ V}$		3.6			0.03			0.43	V/ μs	
		$V_{I(PP)} = 2.5\text{ V}$		2.9			0.03			0.40		
V_n	Equivalent input noise voltage $f = 1\text{ kHz}$, $R_S = 20\ \Omega$		2.5			68			32		$\text{nV}/\sqrt{\text{Hz}}$	
B_{OM}	Maximum output-swing bandwidth $V_O = V_{OH}$, $C_L = 20\text{ pF}$, $R_L = 10\text{ k}\Omega$		320			5			55		kHz	
B_1	Unity-gain bandwidth $V_I = 10\text{ mV}$, $C_L = 20\text{ pF}$		1.7			0.085			0.525		MHz	
ϕ_m	Phase margin $f = B_1$, $C_L = 20\text{ pF}$, $V_I = 10\text{ mV}$		46°			34°			40°			

- NOTES: 4. The typical values of input bias current and input offset current below 5 pA were determined mathematically.
5. This range also applies to each input individually.
6. For low-bias mode, $R_L = 1\text{ M}\Omega$; for medium-bias mode, $R_L = 100\text{ k}\Omega$, and for high-bias mode, $R_L = 10\text{ k}\Omega$.



PARAMETER MEASUREMENT INFORMATION

single-supply versus split-supply test circuits

Because the TLC252, TLC25L2, and TLC25M2 are optimized for single-supply operation, circuit configurations used for the various tests often present some inconvenience since the input signal, in many cases, must be offset from ground. This inconvenience can be avoided by testing the device with split supplies and the output load tied to the negative rail. A comparison of single-supply versus split-supply test circuits is shown below. The use of either circuit gives the same result.

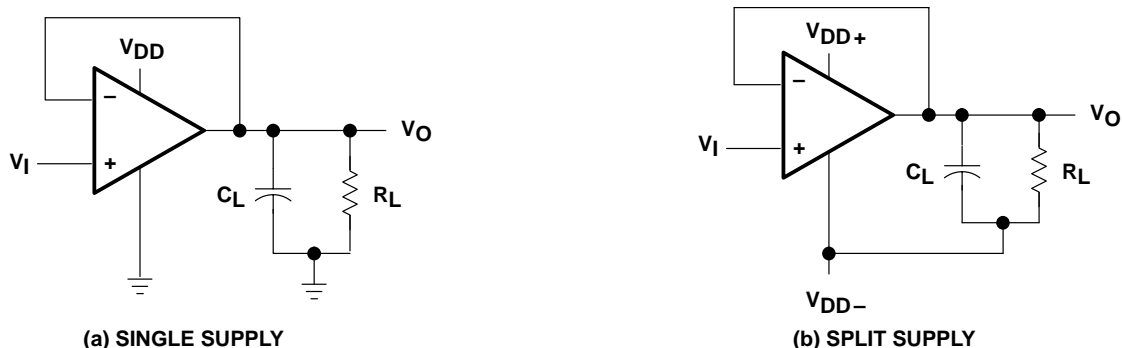

Figure 1. Unity-Gain Amplifier

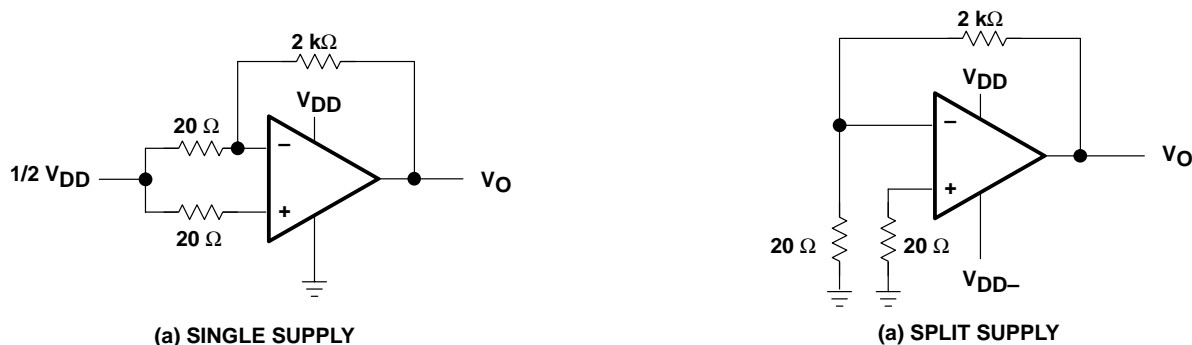

Figure 2. Noise-Test Circuit

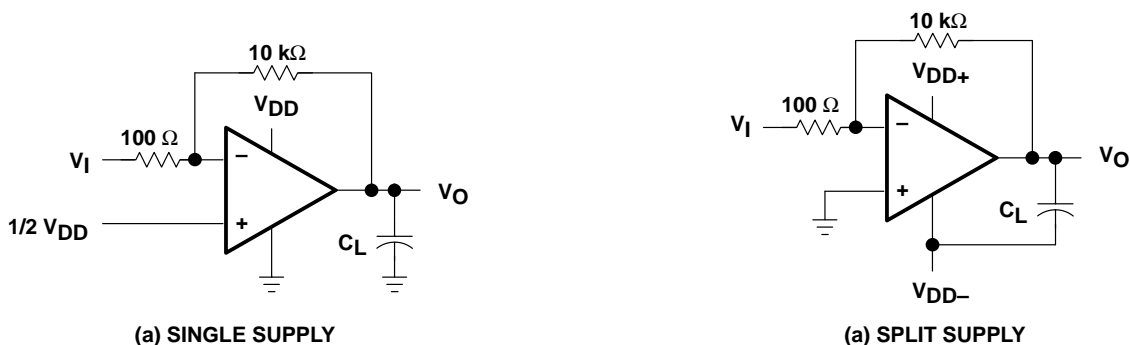

Figure 3. Gain-of-100 Inverting Amplifier

TYPICAL CHARACTERISTICS

Table of Graphs

			FIGURE
I_{DD}	Supply current	vs Supply voltage	4
		vs Free-air temperature	5
A_{VD}	Large-signal differential voltage amplification	Low bias vs Frequency	6
		Medium bias vs Frequency	7
		High bias vs Frequency	8
	Phase shift	Low bias vs Frequency	6
		Medium bias vs Frequency	7
		High bias vs Frequency	8

SUPPLY CURRENT
vs
SUPPLY VOLTAGE

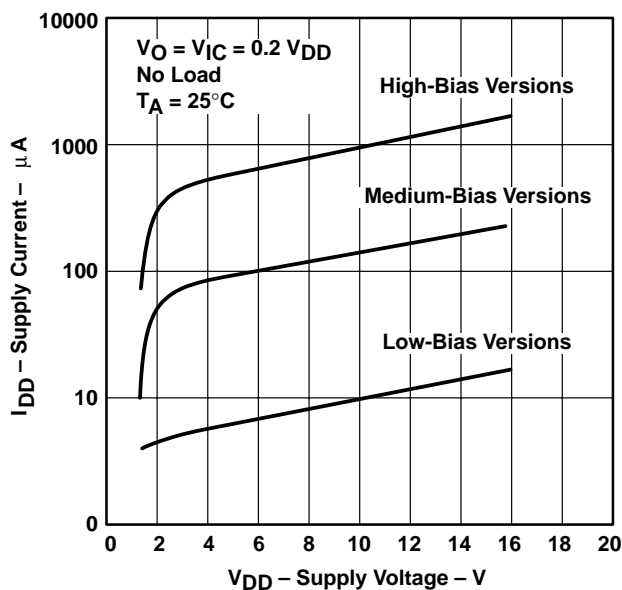

Figure 4

SUPPLY CURRENT
vs
FREE-AIR TEMPERATURE

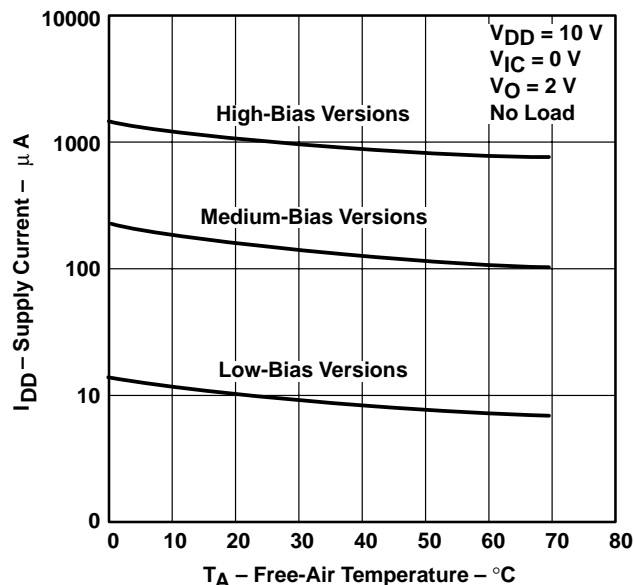

Figure 5

TYPICAL CHARACTERISTICS

**LOW-BIAS LARGE-SIGNAL
 DIFFERENTIAL VOLTAGE AMPLIFICATION
 AND PHASE SHIFT
 vs
 FREQUENCY**

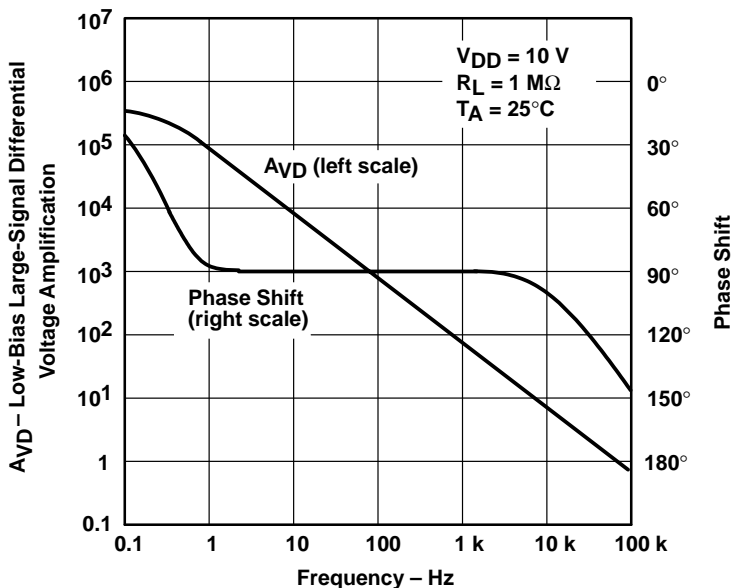

Figure 6

**MEDIUM-BIAS LARGE-SIGNAL
 DIFFERENTIAL VOLTAGE AMPLIFICATION
 AND PHASE SHIFT
 vs
 FREQUENCY**

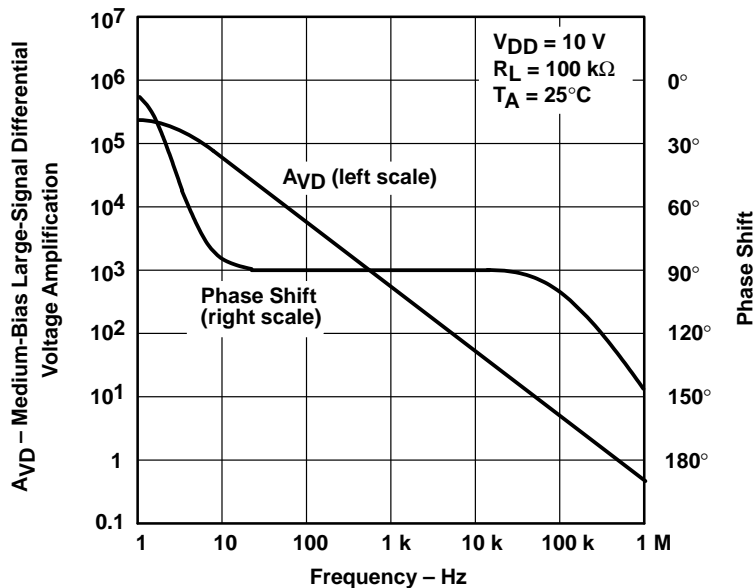

Figure 7



TYPICAL CHARACTERISTICS

HIGH-BIAS LARGE-SIGNAL
 DIFFERENTIAL VOLTAGE AMPLIFICATION
 AND PHASE SHIFT
 VS
 FREQUENCY

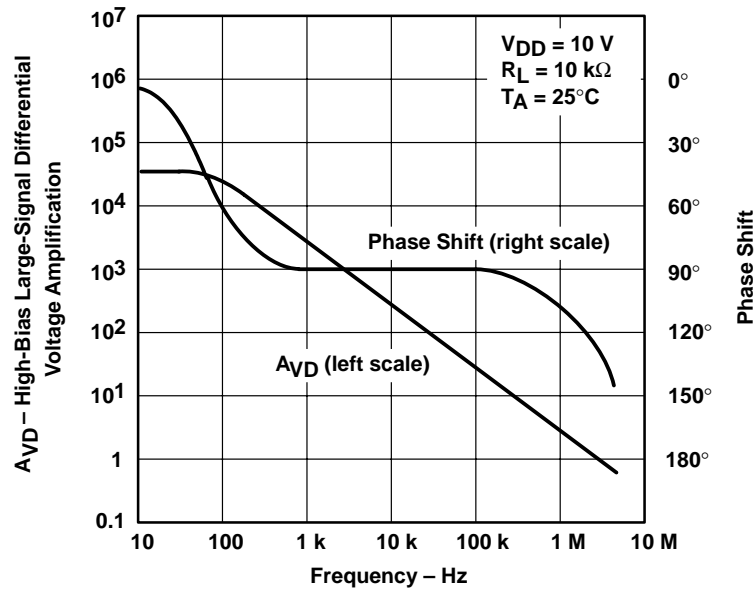

Figure 8

APPLICATION INFORMATION

latch-up avoidance

Junction-isolated CMOS circuits have an inherent parasitic PNP structure that can function as an SCR. Under certain conditions, this SCR may be triggered into a low-impedance state, resulting in excessive supply current. To avoid such conditions, no voltage greater than 0.3 V beyond the supply rails should be applied to any pin. In general, the operational amplifier supplies should be applied simultaneously with, or before, application of any input signals.

output stage considerations

The amplifier's output stage consists of a source-follower-connected pullup transistor and an open-drain pulldown transistor. The high-level output voltage (V_{OH}) is virtually independent of the I_{DD} selection and increases with higher values of V_{DD} and reduced output loading. The low-level output voltage (V_{OL}) decreases with reduced output current and higher input common-mode voltage. With no load, V_{OL} is essentially equal to the potential of V_{DD-}/GND .

supply configurations

Even though the TLC252/25_2C series is characterized for single-supply operation, it can be used effectively in a split-supply configuration if the input common-mode voltage (V_{ICR}), output swing (V_{OL} and V_{OH}), and supply voltage limits are not exceeded.

circuit layout precautions

The user is cautioned that whenever extremely high circuit impedances are used, care must be exercised in layout, construction, board cleanliness, and supply filtering to avoid hum and noise pickup, as well as excessive dc leakages.

PACKAGING INFORMATION

Orderable Device	Status (1)	Package Type	Package Drawing	Pins	Package Qty	Eco Plan (2)	Lead finish/ Ball material (6)	MSL Peak Temp (3)	Op Temp (°C)	Device Marking (4/5)	Samples
TLC252ACD	LIFEBUY	SOIC	D	8	75	RoHS & Green	NIPDAU	Level-1-260C-UNLIM	0 to 70	252AC	
TLC252BCP	LIFEBUY	PDIP	P	8	50	RoHS & Green	NIPDAU	N / A for Pkg Type	0 to 70	TLC252BCP	
TLC252CD	LIFEBUY	SOIC	D	8	75	RoHS & Green	NIPDAU	Level-1-260C-UNLIM	0 to 70	252C	
TLC252CDR	ACTIVE	SOIC	D	8	2500	RoHS & Green	NIPDAU	Level-1-260C-UNLIM	0 to 70	252C	Samples
TLC252CP	LIFEBUY	PDIP	P	8	50	RoHS & Green	NIPDAU	N / A for Pkg Type	0 to 70	TLC252CP	
TLC252CPE4	LIFEBUY	PDIP	P	8	50	RoHS & Green	NIPDAU	N / A for Pkg Type	0 to 70	TLC252CP	
TLC252CPWR	LIFEBUY	TSSOP	PW	8	2000	RoHS & Green	NIPDAU	Level-1-260C-UNLIM	0 to 70	P252	
TLC25L2ACD	LIFEBUY	SOIC	D	8	75	RoHS & Green	NIPDAU	Level-1-260C-UNLIM	0 to 70	25L2AC	
TLC25L2BCP	LIFEBUY	PDIP	P	8	50	RoHS & Green	NIPDAU	N / A for Pkg Type	0 to 70	TLC25L2BC	
TLC25L2CD	LIFEBUY	SOIC	D	8	75	RoHS & Green	NIPDAU	Level-1-260C-UNLIM	0 to 70	25L2C	
TLC25L2CDR	LIFEBUY	SOIC	D	8	2500	RoHS & Green	NIPDAU	Level-1-260C-UNLIM		25L2C	
TLC25L2CP	LIFEBUY	PDIP	P	8	50	RoHS & Green	NIPDAU	N / A for Pkg Type		TLC25L2CP	
TLC25M2ACD	LIFEBUY	SOIC	D	8	75	RoHS & Green	NIPDAU	Level-1-260C-UNLIM	0 to 70	25M2AC	
TLC25M2ACP	LIFEBUY	PDIP	P	8	50	RoHS & Green	NIPDAU	N / A for Pkg Type	0 to 70	TLC25M2AC	
TLC25M2CD	LIFEBUY	SOIC	D	8	75	RoHS & Green	NIPDAU	Level-1-260C-UNLIM	0 to 70	25M2C	
TLC25M2CP	LIFEBUY	PDIP	P	8	50	RoHS & Green	NIPDAU	N / A for Pkg Type	0 to 70	TLC25M2CP	

(1) The marketing status values are defined as follows:

ACTIVE: Product device recommended for new designs.

LIFEBUY: TI has announced that the device will be discontinued, and a lifetime-buy period is in effect.

NRND: Not recommended for new designs. Device is in production to support existing customers, but TI does not recommend using this part in a new design.

PREVIEW: Device has been announced but is not in production. Samples may or may not be available.

OBSELETE: TI has discontinued the production of the device.

(2) **RoHS:** TI defines "RoHS" to mean semiconductor products that are compliant with the current EU RoHS requirements for all 10 RoHS substances, including the requirement that RoHS substance do not exceed 0.1% by weight in homogeneous materials. Where designed to be soldered at high temperatures, "RoHS" products are suitable for use in specified lead-free processes. TI may reference these types of products as "Pb-Free".

RoHS Exempt: TI defines "RoHS Exempt" to mean products that contain lead but are compliant with EU RoHS pursuant to a specific EU RoHS exemption.

Green: TI defines "Green" to mean the content of Chlorine (Cl) and Bromine (Br) based flame retardants meet JS709B low halogen requirements of <=1000ppm threshold. Antimony trioxide based flame retardants must also meet the <=1000ppm threshold requirement.

(3) MSL, Peak Temp. - The Moisture Sensitivity Level rating according to the JEDEC industry standard classifications, and peak solder temperature.

(4) There may be additional marking, which relates to the logo, the lot trace code information, or the environmental category on the device.

(5) Multiple Device Markings will be inside parentheses. Only one Device Marking contained in parentheses and separated by a "~" will appear on a device. If a line is indented then it is a continuation of the previous line and the two combined represent the entire Device Marking for that device.

(6) Lead finish/Ball material - Orderable Devices may have multiple material finish options. Finish options are separated by a vertical ruled line. Lead finish/Ball material values may wrap to two lines if the finish value exceeds the maximum column width.

Important Information and Disclaimer:The information provided on this page represents TI's knowledge and belief as of the date that it is provided. TI bases its knowledge and belief on information provided by third parties, and makes no representation or warranty as to the accuracy of such information. Efforts are underway to better integrate information from third parties. TI has taken and continues to take reasonable steps to provide representative and accurate information but may not have conducted destructive testing or chemical analysis on incoming materials and chemicals. TI and TI suppliers consider certain information to be proprietary, and thus CAS numbers and other limited information may not be available for release.

In no event shall TI's liability arising out of such information exceed the total purchase price of the TI part(s) at issue in this document sold by TI to Customer on an annual basis.

TAPE AND REEL INFORMATION

QUADRANT ASSIGNMENTS FOR PIN 1 ORIENTATION IN TAPE



*All dimensions are nominal

Device	Package Type	Package Drawing	Pins	SPQ	Reel Diameter (mm)	Reel Width W1 (mm)	A0 (mm)	B0 (mm)	K0 (mm)	P1 (mm)	W (mm)	Pin1 Quadrant
TLC252CDR	SOIC	D	8	2500	330.0	12.4	6.4	5.2	2.1	8.0	12.0	Q1
TLC252CPWR	TSSOP	PW	8	2000	330.0	12.4	7.0	3.6	1.6	8.0	12.0	Q1
TLC25L2CDR	SOIC	D	8	2500	330.0	12.4	6.4	5.2	2.1	8.0	12.0	Q1

TAPE AND REEL BOX DIMENSIONS

*All dimensions are nominal

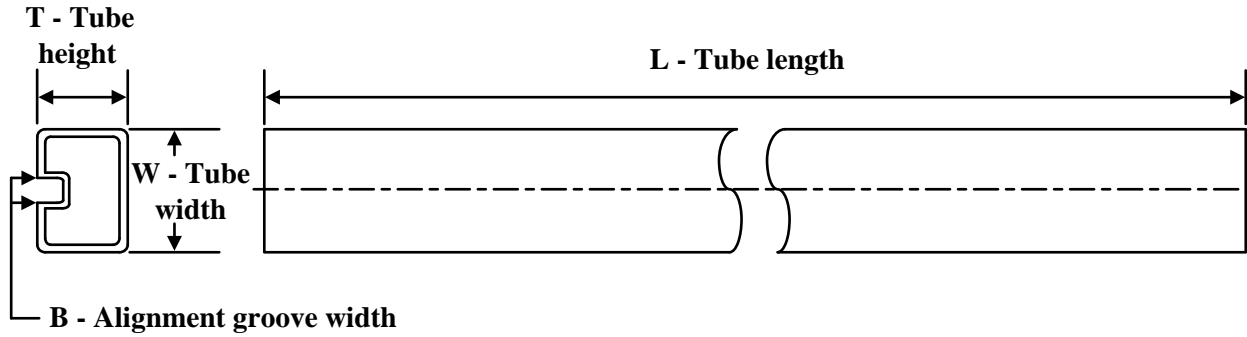
Device	Package Type	Package Drawing	Pins	SPQ	Length (mm)	Width (mm)	Height (mm)
TLC252CDR	SOIC	D	8	2500	340.5	336.1	25.0
TLC252CPWR	TSSOP	PW	8	2000	356.0	356.0	35.0
TLC25L2CDR	SOIC	D	8	2500	340.5	336.1	25.0

TUBE

*All dimensions are nominal

Device	Package Name	Package Type	Pins	SPQ	L (mm)	W (mm)	T (μm)	B (mm)
TLC252ACD	D	SOIC	8	75	507	8	3940	4.32
TLC252ACD	D	SOIC	8	75	505.46	6.76	3810	4
TLC252BCP	P	PDIP	8	50	506	13.97	11230	4.32
TLC252CD	D	SOIC	8	75	505.46	6.76	3810	4
TLC252CD	D	SOIC	8	75	507	8	3940	4.32
TLC252CP	P	PDIP	8	50	506	13.97	11230	4.32
TLC252CPE4	P	PDIP	8	50	506	13.97	11230	4.32
TLC25L2ACD	D	SOIC	8	75	507	8	3940	4.32
TLC25L2ACD	D	SOIC	8	75	505.46	6.76	3810	4
TLC25L2BCP	P	PDIP	8	50	506	13.97	11230	4.32
TLC25L2CD	D	SOIC	8	75	507	8	3940	4.32
TLC25L2CD	D	SOIC	8	75	505.46	6.76	3810	4
TLC25L2CP	P	PDIP	8	50	506	13.97	11230	4.32
TLC25M2ACD	D	SOIC	8	75	507	8	3940	4.32
TLC25M2ACD	D	SOIC	8	75	505.46	6.76	3810	4
TLC25M2ACP	P	PDIP	8	50	506	13.97	11230	4.32
TLC25M2CD	D	SOIC	8	75	505.46	6.76	3810	4
TLC25M2CD	D	SOIC	8	75	507	8	3940	4.32
TLC25M2CP	P	PDIP	8	50	506	13.97	11230	4.32

IMPORTANT NOTICE AND DISCLAIMER

TI PROVIDES TECHNICAL AND RELIABILITY DATA (INCLUDING DATA SHEETS), DESIGN RESOURCES (INCLUDING REFERENCE DESIGNS), APPLICATION OR OTHER DESIGN ADVICE, WEB TOOLS, SAFETY INFORMATION, AND OTHER RESOURCES "AS IS" AND WITH ALL FAULTS, AND DISCLAIMS ALL WARRANTIES, EXPRESS AND IMPLIED, INCLUDING WITHOUT LIMITATION ANY IMPLIED WARRANTIES OF MERCHANTABILITY, FITNESS FOR A PARTICULAR PURPOSE OR NON-INFRINGEMENT OF THIRD PARTY INTELLECTUAL PROPERTY RIGHTS.

These resources are intended for skilled developers designing with TI products. You are solely responsible for (1) selecting the appropriate TI products for your application, (2) designing, validating and testing your application, and (3) ensuring your application meets applicable standards, and any other safety, security, regulatory or other requirements.

These resources are subject to change without notice. TI grants you permission to use these resources only for development of an application that uses the TI products described in the resource. Other reproduction and display of these resources is prohibited. No license is granted to any other TI intellectual property right or to any third party intellectual property right. TI disclaims responsibility for, and you will fully indemnify TI and its representatives against, any claims, damages, costs, losses, and liabilities arising out of your use of these resources.

TI's products are provided subject to [TI's Terms of Sale](#) or other applicable terms available either on [ti.com](https://www.ti.com) or provided in conjunction with such TI products. TI's provision of these resources does not expand or otherwise alter TI's applicable warranties or warranty disclaimers for TI products.

TI objects to and rejects any additional or different terms you may have proposed.

Mailing Address: Texas Instruments, Post Office Box 655303, Dallas, Texas 75265
Copyright © 2023, Texas Instruments Incorporated