

DATA SHEET

For a complete data sheet, please also download:

- The IC06 74HC/HCT/HCU/HCMOS Logic Family Specifications
- The IC06 74HC/HCT/HCU/HCMOS Logic Package Information
- The IC06 74HC/HCT/HCU/HCMOS Logic Package Outlines

74HC/HCT251 8-input multiplexer; 3-state

Product specification
File under Integrated Circuits, IC06

December 1990

8-input multiplexer; 3-state

74HC/HCT251

FEATURES

- True and complement outputs
- Both outputs are 3-state for further multiplexer expansion
- Multifunction capability
- Permits multiplexing from n-lines to one line
- Output capability: standard
- I_{CC} category: MSI

GENERAL DESCRIPTION

The 74HC/HCT251 are high-speed Si-gate CMOS devices and are pin compatible with low power Schottky TTL (LSTTL). They are specified in compliance with JEDEC standard no. 7A.

The 74HC/HCT251 are the logic implementations of single-pole 8-position switches with the state of three select inputs (S₀, S₁, S₂) controlling the switch positions. Assertion (Y) and negation (\bar{Y}) outputs are both provided. The output enable input (\bar{OE}) is active LOW. The logic function provided at the output, when activated, is:

$$Y = \bar{OE} \cdot (I_0 \cdot \bar{S}_0 \cdot \bar{S}_1 \cdot \bar{S}_2 + I_1 \cdot S_0 \cdot \bar{S}_1 \cdot \bar{S}_2 + I_2 \cdot \bar{S}_0 \cdot S_1 \cdot \bar{S}_2 + I_3 \cdot S_0 \cdot S_1 \cdot \bar{S}_2 + I_4 \cdot \bar{S}_0 \cdot \bar{S}_1 \cdot S_2 + I_5 \cdot S_0 \cdot \bar{S}_1 \cdot S_2 + I_6 \cdot \bar{S}_0 \cdot S_1 \cdot S_2 + I_7 \cdot S_0 \cdot S_1 \cdot S_2)$$

Both outputs are in the high impedance OFF-state (Z) when the output enable input is HIGH, allowing multiplexer expansion by tying the outputs.

QUICK REFERENCE DATA

GND = 0 V; T_{amb} = 25 °C; t_r = t_f = 6 ns

| SYMBOL | PARAMETER | CONDITIONS | TYPICAL | | UNIT |
|-------------------------------------|---|---|---------|-----|------|
| | | | HC | HCT | |
| t _{PHL} / t _{PLH} | propagation delay | C _L = 15 pF; V _{CC} = 5 V | | | |
| | I _n to Y | | 15 | 19 | ns |
| | I _n to \bar{Y} | | 17 | 19 | ns |
| | S _n to Y | | 20 | 20 | ns |
| | S _n to \bar{Y} | | 21 | 21 | ns |
| C _I | input capacitance | | 3.5 | 3.5 | pF |
| C _{PD} | power dissipation capacitance per package | notes 1 and 2 | 44 | 46 | pF |

Notes

1. C_{PD} is used to determine the dynamic power dissipation (P_D in μW):

$$P_D = C_{PD} \times V_{CC}^2 \times f_i + \sum (C_L \times V_{CC}^2 \times f_o) \text{ where:}$$

f_i = input frequency in MHz

f_o = output frequency in MHz

∑ (C_L × V_{CC}² × f_o) = sum of outputs

C_L = output load capacitance in pF

V_{CC} = supply voltage in V

2. For HC the condition is V_I = GND to V_{CC}
For HCT the condition is V_I = GND to V_{CC} – 1.5 V

ORDERING INFORMATION

See "74HC/HCT/HCU/HCMOS Logic Package Information".

8-input multiplexer; 3-state

74HC/HCT251

PIN DESCRIPTION

| PIN NO. | SYMBOL | NAME AND FUNCTION |
|----------------------------|-----------------|--|
| 4, 3, 2, 1, 15, 14, 13, 12 | I_0 to I_7 | multiplexer inputs |
| 5 | Y | multiplexer output |
| 6 | \bar{Y} | complementary multiplexer output |
| 7 | \overline{OE} | 3-state output enable input (active LOW) |
| 8 | GND | ground (0 V) |
| 11, 10, 9 | S_0, S_1, S_2 | select inputs |
| 16 | V_{CC} | positive supply voltage |

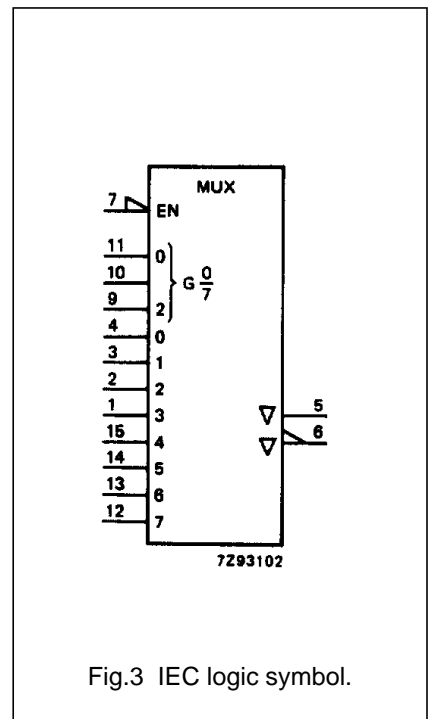
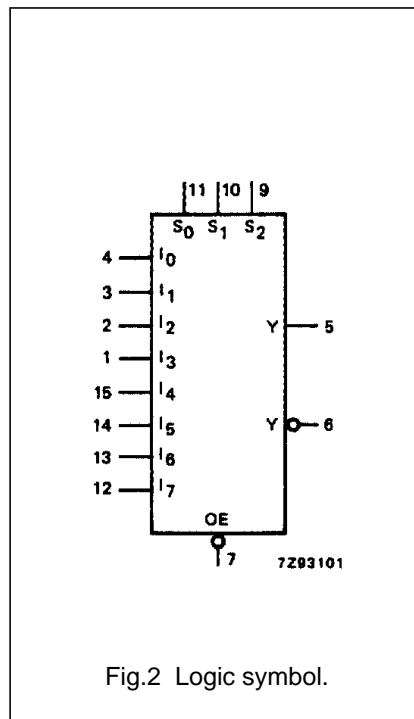
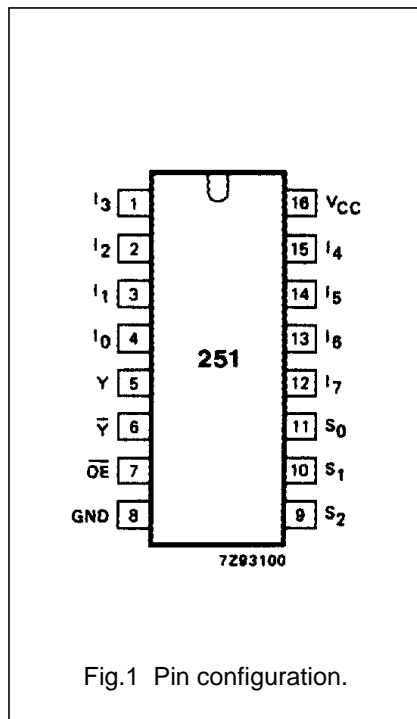

8-input multiplexer; 3-state

74HC/HCT251

FUNCTION TABLE

| INPUTS | | | | | | | | | | | | OUTPUTS | |
|-----------------|-------|-------|-------|-------|-------|-------|-------|-------|-------|-------|-------|----------------|---|
| \overline{OE} | S_2 | S_1 | S_0 | I_0 | I_1 | I_2 | I_3 | I_4 | I_5 | I_6 | I_7 | \overline{Y} | Y |
| H | X | X | X | X | X | X | X | X | X | X | X | Z | Z |
| L | L | L | L | L | X | X | X | X | X | X | X | H | L |
| L | L | L | L | H | X | X | X | X | X | X | X | L | H |
| L | L | L | H | X | L | X | X | X | X | X | X | H | L |
| L | L | L | H | X | H | X | X | X | X | X | X | L | H |
| L | L | H | L | X | X | L | X | X | X | X | X | H | L |
| L | L | H | L | X | X | H | X | X | X | X | X | L | H |
| L | L | H | H | X | X | X | L | X | X | X | X | H | L |
| L | L | H | H | X | X | X | H | X | X | X | X | L | H |
| L | H | L | L | X | X | X | X | L | X | X | X | H | L |
| L | H | L | L | X | X | X | X | H | X | X | X | L | H |
| L | H | L | H | X | X | X | X | X | L | X | X | H | L |
| L | H | L | H | X | X | X | X | X | H | X | X | L | H |
| L | H | H | L | X | X | X | X | X | X | L | X | H | L |
| L | H | H | L | X | X | X | X | X | X | H | X | L | H |
| L | H | H | H | X | X | X | X | X | X | X | L | H | L |
| L | H | H | H | X | X | X | X | X | X | X | H | L | H |

Note

- 1. H = HIGH voltage level
- L = LOW voltage level
- X = don't care
- Z = high impedance OFF-state

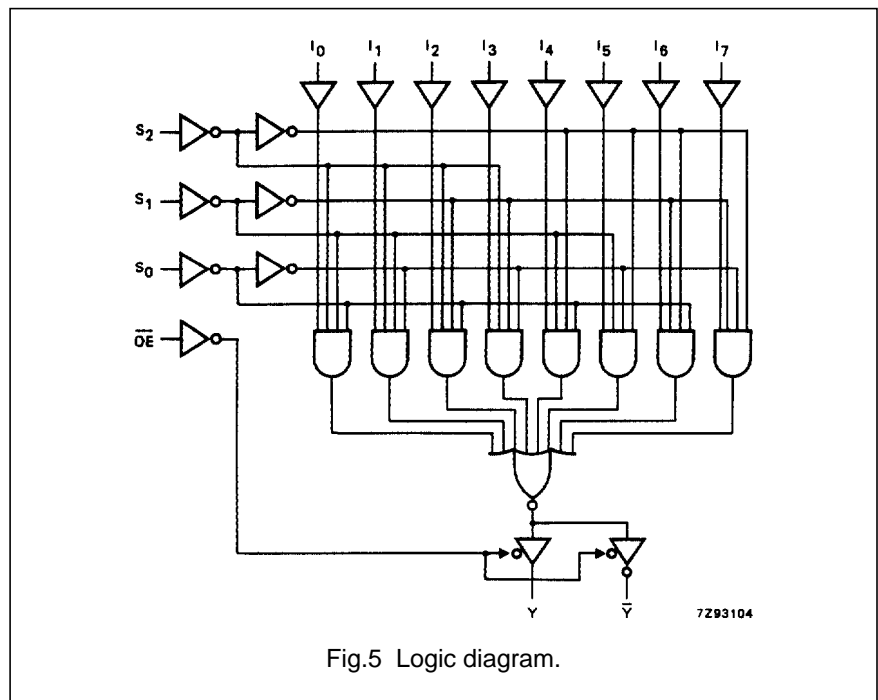
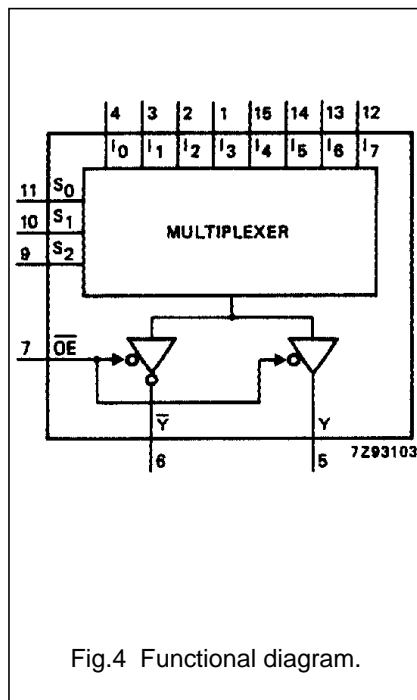

8-input multiplexer; 3-state

74HC/HCT251

DC CHARACTERISTICS FOR 74HC

For the DC characteristics see *"74HC/HCT/HCU/HCMOS Logic Family Specifications"*.

Output capability: standard

I_{CC} category: MSI

AC CHARACTERISTICS FOR 74HC

GND = 0 V; t_r = t_f = 6 ns; C_L = 50 pF

| SYMBOL | PARAMETER | T _{amb} (°C) | | | | | | UNIT | TEST CONDITIONS | | |
|-------------------------------------|--|-----------------------|----------------|-----------------|------------|-----------------|-------------|-----------------|------------------------|-------------------|--------------|
| | | 74HC | | | | | | | V _{CC} (V) | WAVEFORMS | |
| | | +25 | | | -40 to +85 | | -40 to +125 | | | | |
| | | min. | typ. | max. | min. | max. | min. | | | | max. |
| t _{PHL} / t _{PLH} | propagation delay I _n to Y | | 50 18 14 | 170 34 29 | | 215 43 37 | | 255 51 43 | ns | 2.0 4.5 6.0 | Fig.6 |
| t _{PHL} / t _{PLH} | propagation delay I _n to \bar{Y} | | 55 20 16 | 175 35 30 | | 220 44 37 | | 265 53 45 | ns | 2.0 4.5 6.0 | Fig.7 |
| t _{PHL} / t _{PLH} | propagation delay S _n to Y | | 66 24 19 | 205 41 35 | | 255 51 43 | | 310 62 53 | ns | 2.0 4.5 6.0 | Fig.6 |
| t _{PHL} / t _{PLH} | propagation delay S _n to \bar{Y} | | 69 25 20 | 205 41 35 | | 255 51 43 | | 310 62 53 | ns | 2.0 4.5 6.0 | Fig.7 |
| t _{PZH} / t _{PZL} | 3-state output enable time \overline{OE} to Y, \bar{Y} | | 36 13 10 | 140 28 24 | | 175 35 30 | | 210 42 36 | ns | 2.0 4.5 6.0 | Fig.7 |
| t _{PHZ} / t _{PLZ} | 3-state output disable time \overline{OE} to Y, \bar{Y} | | 39 14 11 | 140 28 24 | | 170 35 30 | | 210 42 36 | ns | 2.0 4.5 6.0 | Fig.7 |
| t _{THL} / t _{TLH} | output transition time | | 19 7 6 | 75 15 13 | | 95 19 16 | | 110 22 19 | ns | 2.0 4.5 6.0 | Figs 6 and 7 |

8-input multiplexer; 3-state

74HC/HCT251

DC CHARACTERISTICS FOR 74HCT

For the DC characteristics see *"74HC/HCT/HCU/HCMOS Logic Family Specifications"*.

Output capability: standard

I_{CC} category: MSI

Note to HCT types

The value of additional quiescent supply current (ΔI_{CC}) for a unit load of 1 is given in the family specifications.

To determine ΔI_{CC} per input, multiply this value by the unit load coefficient shown in the table below.

| INPUT | UNIT LOAD COEFFICIENT |
|---------------------------------|-----------------------|
| I _n | 1.00 |
| S ₀ | 1.50 |
| S ₁ , S ₂ | 1.50 |
| \overline{OE} | 1.50 |

AC CHARACTERISTICS FOR HCT

GND = 0 V; t_r = t_f = 6 ns; C_L = 50 pF

| SYMBOL | PARAMETER | T _{amb} (°C) | | | | | | | UNIT | TEST CONDITIONS | |
|-------------------------------------|---|-----------------------|------|------|------------|------|-------------|------|------|------------------------|--------------|
| | | 74HCT | | | | | | | | V _{CC} (V) | WAVEFORMS |
| | | +25 | | | -40 to +85 | | -40 to +125 | | | | |
| | | min. | typ. | max. | min. | max. | min. | max. | | | |
| t _{PHL} / t _{PLH} | propagation delay I _n to Y | | 22 | 35 | | 44 | | 53 | ns | 4.5 | Fig.6 |
| t _{PHL} / t _{PLH} | propagation delay I _n to \overline{Y} | | 22 | 35 | | 44 | | 53 | ns | 4.5 | Fig.7 |
| t _{PHL} / t _{PLH} | propagation delay S _n to Y | | 24 | 44 | | 55 | | 66 | ns | 4.5 | Fig.6 |
| t _{PHL} / t _{PLH} | propagation delay S _n to \overline{Y} | | 25 | 44 | | 55 | | 66 | ns | 4.5 | Fig.7 |
| t _{PZH} / t _{PZL} | 3-state output enable time \overline{OE} to Y, \overline{Y} | | 13 | 28 | | 35 | | 42 | ns | 4.5 | Fig.7 |
| t _{PHZ} / t _{PLZ} | 3-state output disable time \overline{OE} to Y, \overline{Y} | | 14 | 28 | | 35 | | 42 | ns | 4.5 | Fig.7 |
| t _{THL} / t _{TLH} | output transition time | | 7 | 15 | | 19 | | 22 | ns | 4.5 | Figs 6 and 7 |

8-input multiplexer; 3-state

74HC/HCT251

AC WAVEFORMS

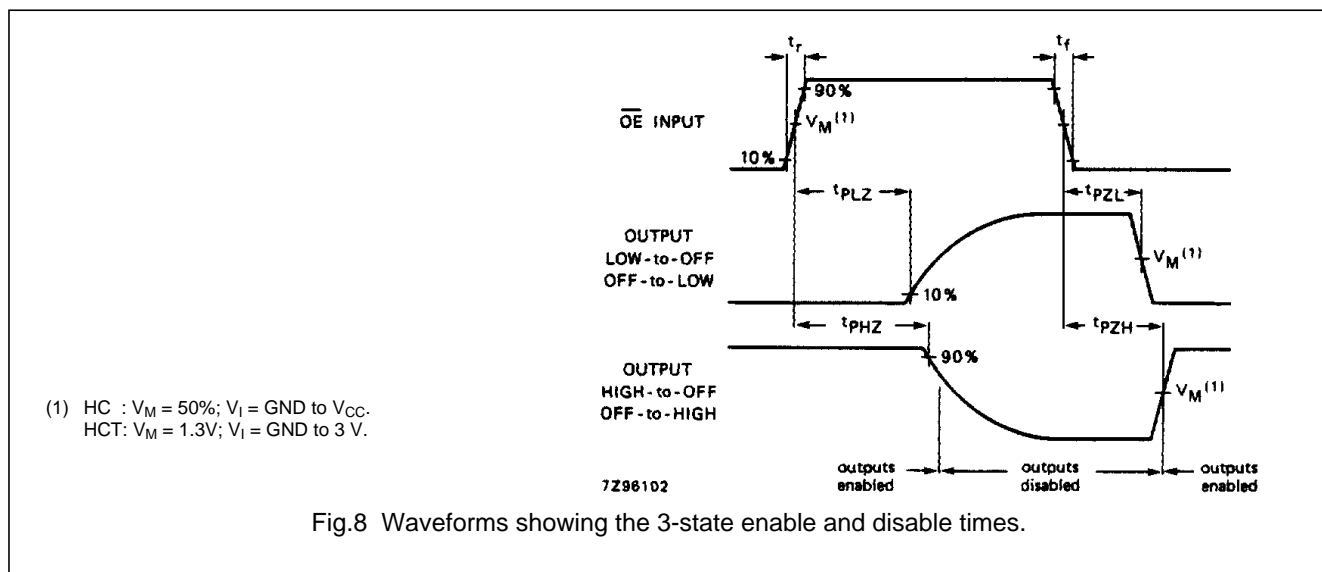
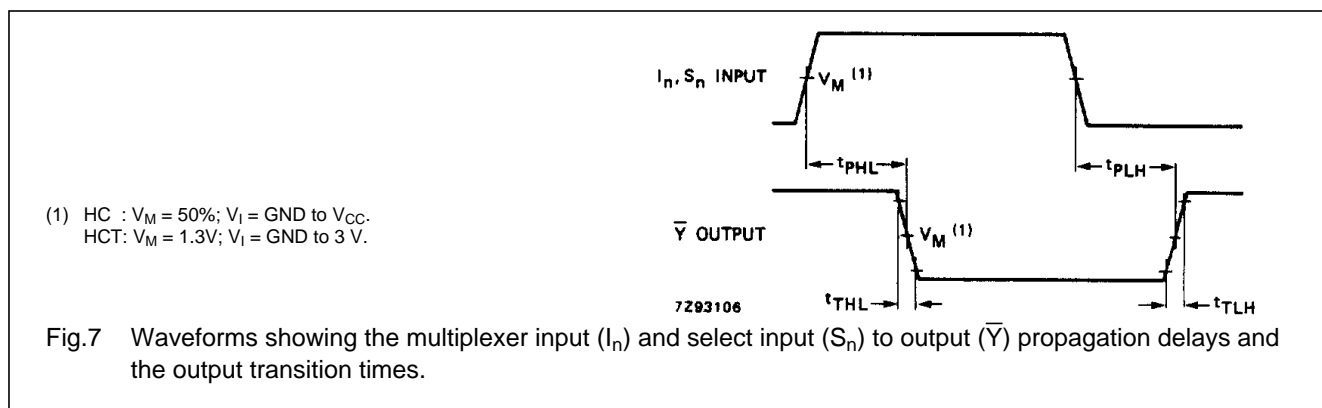
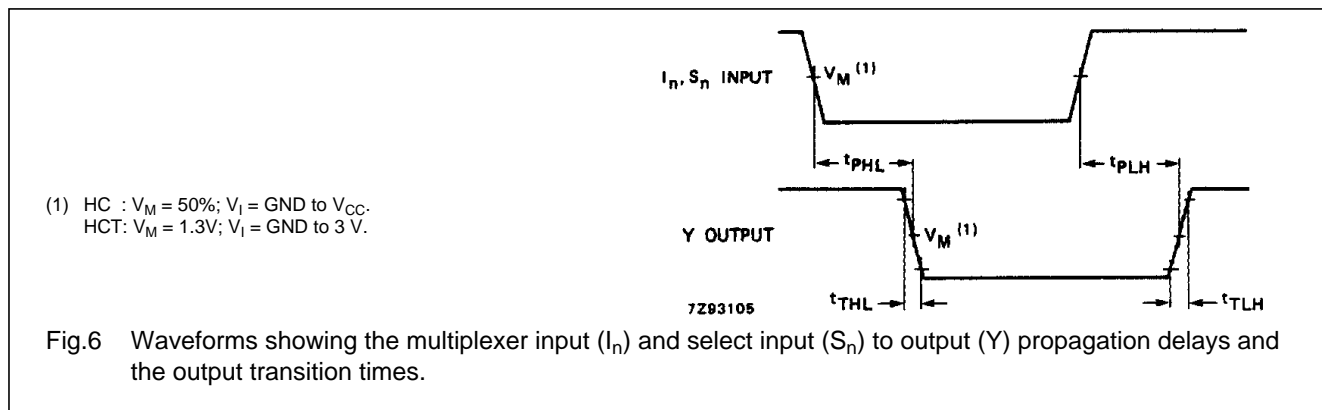

PACKAGE OUTLINES

See "74HC/HCT/HCU/HCMOS Logic Package Outlines".