



POWER SUPPLY

1AC 24V 480W

- AC 100-240V Wide-range input
- Width only 48mm
- Efficiency up to 95.6%
- Excellent partial load efficiency
- 20% Output power reserves (PowerBoost)
- Safe Hiccup^{PLUS} overload mode
- Easy fuse breaking - 3 times nominal current for 12ms
- Active power factor correction (PFC)
- Minimal inrush current surge
- Full power between -25°C and +60°C
- Remote ON / OFF function
- DC-OK relay contact
- 3 Year warranty

PRODUCT DESCRIPTION

The DIMENSION CP-Series units are high-end power supplies in a medium price range without compromising quality, reliability and performance. The CP-Series is part of the DIMENSION power supply family. The most outstanding features of CP20 are the high efficiency, advanced inrush current limitation, active PFC and the wide operational temperature range.

The CP20.242 features an enhanced DC input voltage range.

The device also offers PowerBoost: Power reserves of 20%, which may even be used continuously at temperatures up to +45°C.

High immunity to transients and power surges as well as low electromagnetic emission, a DC-OK relay contact and a large international approval package for a variety of applications makes this unit suitable for nearly every situation.

SHORT-FORM DATA

Output voltage	DC 24V	Nominal
Adjustment range	24-28Vdc	Factory setting 24.1V
Output current	20-17.1A	Up to +60°C ambient
	15-13A	At +70°C ambient
		Derate linearly between +60°C and +70°C
PowerBoost	24A	Up to +45°C ambient
		Linear decrease to nominal power between +45°C and +60°C
Input voltage AC	AC 100-240V	-15% / +10%
Mains frequency	50-60Hz	±6%
Input current AC	4.26 / 2.23A	At 120 / 230Vac
Power factor	0.996 / 0.98	At 120 / 230Vac
Input voltage DC	DC 110-300V	±20%
Input current DC	4.64 / 1.66A	At 110 / 300Vdc
AC Inrush current	10 / 4.5A _{peak}	At 120 / 230Vac
Efficiency	94.2 / 95.6%	At 120 / 230Vac
Power losses	29.6 / 22.1W	At 120 / 230Vac
Hold-up time	32 / 32ms	At 120 / 230Vac
Temperature range	-25°C to +70°C	
Size (w x h x d)	48x124x127mm	Without DIN rail
Weight	830g	

ORDER NUMBERS

Description:	Power supply CP20.242-xx
Order Number:	CP20.242
	Enhanced DC input
Accessories:	
ZM10.WALL	Wall/Panel mount bracket

MAIN APPROVALS

For details and the complete approval list, see chapter 20.



Index

1	Intended Use.....	3	21	Regulatory Product Compliance.....	21
2	Installation Instructions.....	3	22	Physical Dimensions And Weight.....	22
3	AC-Input.....	4	23	Accessories.....	23
4	DC-Input.....	5	23.1	ZM10.Wall - Wall/Panel Mount Bracket..	23
5	Input Inrush Current.....	6	23.2	UF20.241 - Buffer Module.....	23
6	Output.....	7	23.3	YR40.241 - Redundancy Module.....	24
7	Hold-up Time.....	9	23.4	YR40.242 - Redundancy Module.....	24
8	DC-OK Relay Contact.....	10	23.5	YR40.245 - Redundancy Module.....	24
9	Efficiency and Power Losses.....	11	24	Application Notes.....	25
10	Lifetime Expectancy.....	12	24.1	Peak Current Capability.....	25
11	MTBF.....	12	24.2	Output Circuit Breakers.....	26
12	Functional Diagram.....	13	24.3	Parallel Use to Increase Output Power...	27
13	Terminals And Wiring.....	14	24.4	Parallel Use for Redundancy.....	28
14	Front Side And User Elements.....	15	24.5	Series Operation.....	29
15	EMC.....	16	24.6	Charging of Batteries.....	29
16	Environment.....	17	24.7	Two Phase Operation.....	29
17	Protection Features.....	18	24.8	Use in a Tightly Sealed Enclosure.....	30
18	Safety Features.....	18	24.9	Mounting Orientations.....	31
19	Dielectric Strength.....	19			
20	Approved, Fulfilled or Tested Standards.....	20			

The information given in this document is correct to the best of our knowledge and experience at the time of publication. If not expressly agreed otherwise, this information does not represent a warranty in the legal sense of the word. As the state of our knowledge and experience is constantly changing, the information in this data sheet is subject to revision. We therefore kindly ask you to always use the latest issue of this document (available under www.pulspower.com).

No part of this document may be reproduced or utilized in any form without our prior permission in writing.

Packaging and packaging aids can and should always be recycled. The product itself may not be disposed of as domestic refuse.

TERMINOLOGY AND ABBREVIATIONS

PE and \oplus Symbol	PE is the abbreviation for Protective Earth and has the same meaning as the symbol \oplus .
Earth, Ground	This document uses the term "earth" which is the same as the U.S. term "ground".
t.b.d.	To be defined, value or description will follow later.
AC 230V	A figure displayed with the AC or DC before the value represents a nominal voltage with standard tolerances (usually $\pm 15\%$) included. E.g.: DC 12V describes a 12V battery disregarding whether it is full (13.7V) or flat (10V)
230Vac	A figure with the unit (Vac) at the end is a momentary figure without any additional tolerances included.
50Hz vs. 60Hz	As long as not otherwise stated, AC 230V parameters are valid at 50Hz mains frequency.
may	A key word indicating flexibility of choice with no implied preference.
shall	A key word indicating a mandatory requirement.
should	A key word indicating flexibility of choice with a strongly preferred implementation.

1. Intended Use

This device is designed for installation in an enclosure and is intended for commercial use, such as in industrial control, process control, monitoring and measurement equipment or the like.

Do not use this device in equipment, where malfunctioning may cause severe personal injury or threaten human life without additional appropriate safety devices, that are suited for the application. If this device is used in a manner outside of its specification, the protection provided by the device may be impaired.

2. Installation Instructions

⚠ WARNING Risk of electrical shock, fire, personal injury or death.

- Turn power off before working on the device. Protect against inadvertent re-powering.
- Do not open, modify or repair the device.
- Use caution to prevent any foreign objects from entering the housing.
- Do not use in wet locations or in areas where moisture or condensation can be expected.
- Do not touch during power-on, and immediately after power-off. Hot surfaces may cause burns.

This device may only be installed and put into operation by qualified personnel. This device does not contain serviceable parts. The tripping of an internal fuse is caused by an internal defect. If damage or malfunction should occur during installation or operation, immediately turn power off and send the device to the factory for inspection.

Install the device in an enclosure providing protection against electrical, mechanical and fire hazards. Install the device onto a DIN rail according to EN 60715 with the input terminals on the bottom of the device. Other mounting orientations require a reduction in output current.

Make sure that the wiring is correct by following all local and national codes. Use appropriate copper cables that are designed for a minimum operating temperature of 60°C for ambient temperatures up to +45°C, 75°C for ambient temperatures up to +60°C and 90°C for ambient temperatures up to +70°C. Ensure that all strands of a stranded wire enter the terminal connection. Use ferrules for wires on the input terminals. Unused screw terminals should be securely tightened.

The device is designed for use in pollution degree 2 areas in controlled environments. No condensation or frost is allowed.

The enclosure of the device provides a degree of protection of IP20. The housing does not provide protection against spilled liquids.

The isolation of the device is designed to withstand impulse voltages of overvoltage category III according to IEC 60664-1.

The device is designed as "Class of Protection I" equipment according to IEC 61140. Do not use without a proper PE (Protective Earth) connection.

The device is suitable to be supplied from TN, TT or IT mains networks. The continuous voltage between the input terminals and the PE potential must not exceed 300Vac.

The input can also be powered from a battery or a similar DC source. The continuous voltage between the supply voltage and the PE/ground potential must not exceed 375Vdc.

A disconnecting means shall be provided for the input of the device.

This device is designed for convection cooling and does not require an external fan. Do not obstruct airflow and do not cover ventilation grid!

The device is designed for altitudes up to 5000m. Above 2000m a reduction in output current and over voltage category is required.

Keep the following installation clearances: 40mm on top, 20mm on the bottom, 5mm on the left and right side. Increase the 5mm to 15mm in case the adjacent device is a heat source. When the device is permanently loaded with less than 50%, the 5mm can be reduced to zero.

The device is designed, tested and approved for branch circuits up to 32A (IEC) and 30A (UL) without additional protection device. If an external fuse is utilized, do not use circuit breakers smaller than 10A B- or C-Characteristic to avoid a nuisance tripping of the circuit breaker.

The maximum surrounding air temperature is +70°C. The operational temperature is the same as the ambient or surrounding air temperature and is defined 2cm below the device.

The device is designed to operate in areas between 5% and 95% relative humidity.

3. AC-Input

The device is suitable to be supplied from TN-, TT- or IT-mains networks with AC voltage. For suitable DC supply voltages see chapter 4.

AC input	nom.	AC 100-240V	
AC input range		85-264Vac	
		264-300Vac	Occasionally for maximal 500ms
Allowed voltage L or N to earth	max.	300Vac	Continuous, according to IEC 60664-1
Input frequency	nom.	50-60Hz	±6%
Turn-on voltage	typ.	82Vac	Steady-state value, see Fig. 3-1
Shut-down voltage	typ.	72Vac	Steady-state value, see Fig. 3-1
External input protection	See recommendations in chapter 2.		

		AC 100V	AC 120V	AC 230V	
Input current	typ.	5.15A	4.26A	2.23A	At 24V, 20A, see Fig. 3-3
Power factor *)	typ.	0.996	0.996	0.98	At 24V, 20A, see Fig. 3-4
Crest factor **)	typ.	1.65	1.63	1.63	At 24V, 20A
Start-up delay	typ.	450ms	450ms	450ms	See Fig. 3-2
Rise time	typ.	145ms	145ms	145ms	At 24V, 20A const. current load, 0mF load capacitance, see Fig. 3-2
	typ.	160ms	160ms	160ms	At 24V, 20A const. current load, 20mF load capacitance, see Fig. 3-2
Turn-on overshoot	max.	200mV	200mV	200mV	In single use mode, see Fig. 3-2

*) The power factor is the ratio of the true (or real) power to the apparent power in an AC circuit.

**) The crest factor is the mathematical ratio of the peak value to RMS value of the input current waveform.

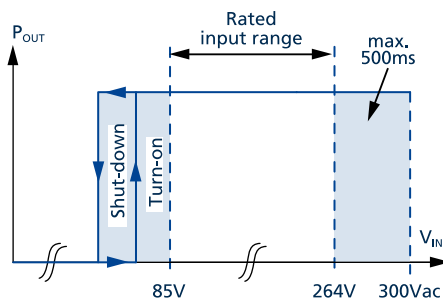

Fig. 3-1: Input voltage range

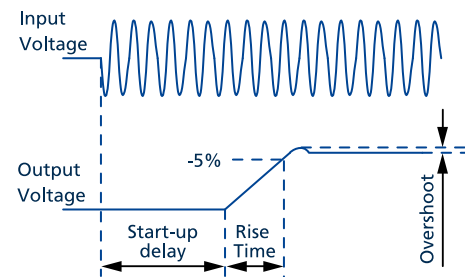

Fig. 3-2: Turn-on behavior, definitions

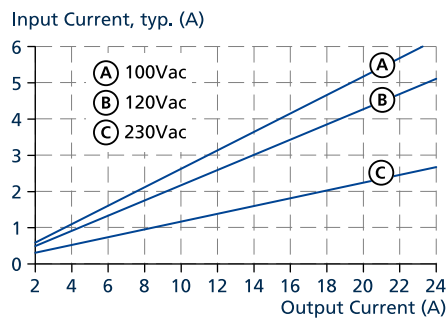

Fig. 3-3: Input current vs. output current at 24V output voltage

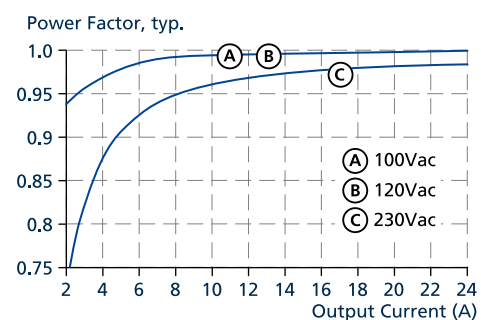

Fig. 3-4: Power factor vs. output current at 24V output voltage

4. DC-Input

DC input	nom.	DC 110-300V	±20%
DC input range		88-360Vdc	
DC input current	typ.	4.64A	At 110Vdc, 24V, 20A
	typ.	1.66A	At 300Vdc, 24V, 20A
Allowed voltage (+) or (-) input to earth	max.	375Vdc	Continuous, according to IEC 60664-1
Turn-on voltage	typ.	80Vdc	Steady state value
Shut-down voltage	typ.	70Vdc	Steady state value

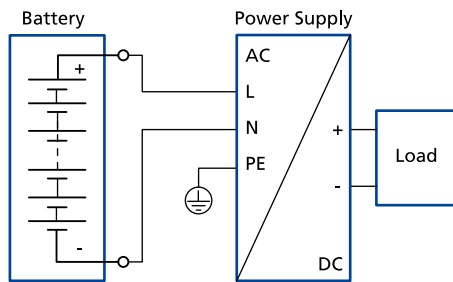

Fig. 4-1: Wiring for DC Input

The device is suitable to be supplied from a DC input voltage.

Instructions for DC use:

- a) Use a battery or a similar DC source.



A supply from the intermediate DC-bus of a frequency converter is not recommended and can cause a malfunction or damage the unit.

- b) Connect (+) pole to L and (-) pole to N.
- c) Connect the PE terminal to an earth wire or to the machine ground.

5. Input Inrush Current

An active inrush limitation circuit limits the input inrush current after turn-on of the input voltage. The charging current into EMI suppression capacitors is disregarded in the first microseconds after switch-on.

		AC 100V	AC 120V	AC 230V	
Inrush current I_{peak}	max.	15A _{peak}	12A _{peak}	5.5A _{peak}	Temperature independent
	typ.	12A _{peak}	10A _{peak}	4.5A _{peak}	Temperature independent
Inrush energy I^2t	max.	1A ² s	1A ² s	1A ² s	Temperature independent

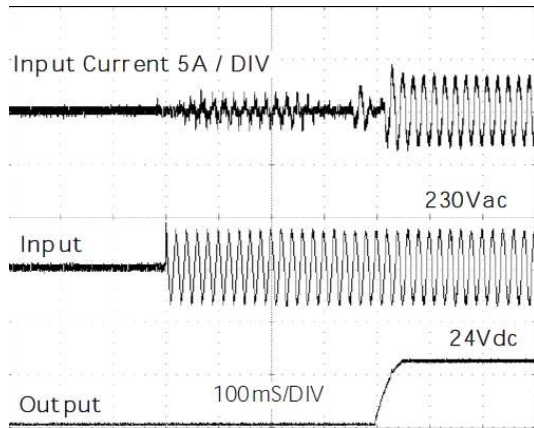

Fig. 5-1: Typical turn-on behaviour at nominal load and 25°C ambient

6. Output

The output provides a SELV/PELV/EST1 rated voltage, which is galvanically isolated from the input voltage.

The output is designed to supply any kind of loads, including capacitive and inductive loads. If extreme large capacitors, such as EDLCs (electric double layer capacitors or "UltraCaps") with a capacitance >1F are connected to the output, the unit might charge the capacitor in an intermittent mode.

The output is electronically protected against overload, no-load and short-circuits. In case of a protection event, audible noise may occur.

Output voltage	nom.	24V	
Adjustment range		24-28V	Guaranteed value
	max.	30V	This is the maximum output voltage which can occur at the clockwise end position of the potentiometer due to tolerances. It is not a guaranteed value which can be achieved.
Factory settings	typ.	24.1V	±0.2% in "single use" mode at full load, cold unit
	typ.	24.1V	±0.2% in "parallel use" mode at 20A, cold unit (results to typ. 23.9V ^{±0.2%} at 24A and typ. 25.1V ^{±0.2%} at no load)
Line regulation	max.	10mV	Between 85 and 300Vac input voltage change
Load regulation	max.	100mV	Between 0 and 24A in "single use" mode, static value
	typ.	1000mV	Between 0 and 20A in "parallel use" mode, static value, see Fig. 6-2
Ripple and noise voltage	max.	50mVpp	Bandwidth 20Hz to 20MHz, 50Ohm
Output current	nom.	20A	At 24V and up to +60°C ambient temperature, see Fig. 6-1
	nom.	15A	At 24V and +70°C ambient temperature, see Fig. 16-1
	nom.	17.1A	At 28V and up to +60°C ambient temperature, see Fig. 6-1
	nom.	13A	At 28V and +70°C ambient temperature, see Fig. 16-1 Derate linearly between +60°C and +70°C, see chapter 16
PowerBoost ¹⁾	nom.	24A	At 24V and up to +45°C ambient temperature, see Fig. 16-1
	nom.	20.6A	At 28V and up to +45°C ambient temperature, see Fig. 16-1 PowerBoost decreases linearly to nominal power between +45°C and +60°C, see chapter 16
Fuse breaking current	typ.	60A	Up to 12ms once every five seconds, see Fig. 6-2. The fuse braking current is an enhanced transient current which helps to trip fuses on faulty output branches. The output voltage stays above 20V.
Overload behavior	Continuous current		For output voltage above 13Vdc, see Fig. 6-1
	Intermittent current ²⁾		For output voltage below 13Vdc, see Fig. 6-1
Overload/ short-circuit current	max.	29.8A	Continuous current, see Fig. 6-1
	typ.	29A	Intermittent current peak value for typ. 2s Load impedance 10mOhm, see Fig. 6-2. Discharge current of output capacitors is not included.
	max.	9.8A	Intermittent current average value (R.M.S.) Load impedance 10mOhm, see Fig. 6-2
Output capacitance	typ.	8500µF	Included inside the power supply
Back-feeding loads	max.	35V	The unit is resistant and does not show malfunctioning when a load feeds back voltage to the power supply. It does not matter whether the power supply is on or off. The absorbing energy can be calculated according to the built-in large sized output capacitor.

1) PowerBoost

This power/current is continuously allowed up to an ambient temperature of +45°C.
Above +45°C, do not use this power/current longer than a duty cycle of 10% and/or not longer than 1 minute every 10 minutes.

- 2) At heavy overloads (when output voltage falls below 13V), the power supply delivers continuous output current for 2s. After this, the output is switched off for approx. 18s before a new start attempt is automatically performed. This cycle is repeated as long as the overload exists. If the overload has been cleared, the device will operate normally. See Fig. 6-3.

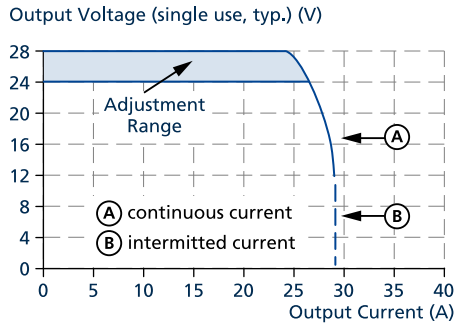

Fig. 6-1: Output voltage vs. output current, typ.

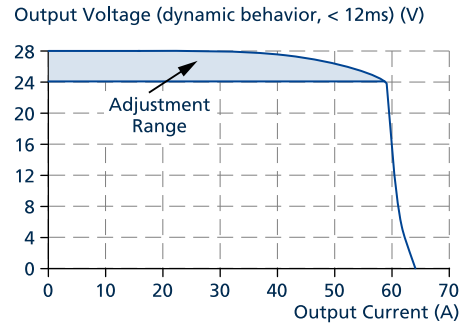

Fig. 6-2: Dynamic overcurrent capability, typ.

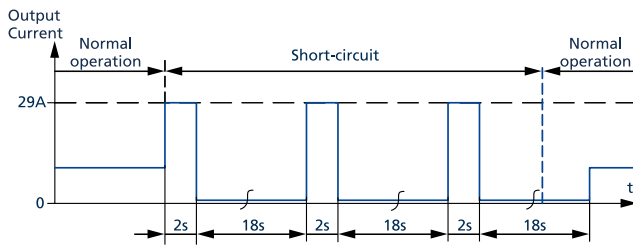

Fig. 6-3: Short-circuit on output, Hiccup^{PLUS} mode, typ.

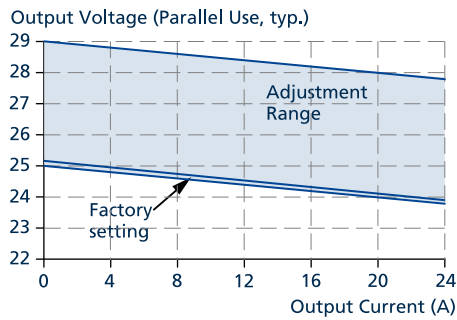

Fig. 6-4: Output voltage in "parallel use" mode, typ.

7. Hold-up Time

The hold-up time is the time during which a power supply's output voltage remains within specification following the loss of input power. The hold-up time is output load dependent. At no load, the hold-up time can be up to several seconds. The green DC-OK LED is also on during this time.

		AC 100V	AC 120V	AC 230V	
Hold-up time	typ.	65ms	65ms	65ms	At 24V, 10A, see Fig. 7-1
	min.	54ms	54ms	54ms	At 24V, 10A, see Fig. 7-1
	typ.	32ms	32ms	32ms	At 24V, 20A, see Fig. 7-1
	min.	24ms	24ms	24ms	At 24V, 20A, see Fig. 7-1

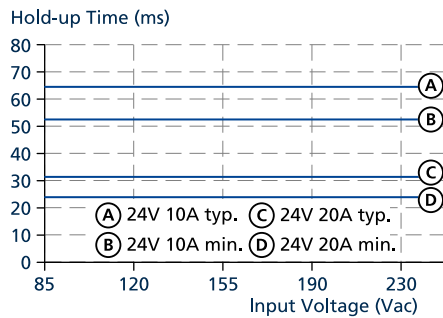

Fig. 7-1: Hold-up time vs. input voltage

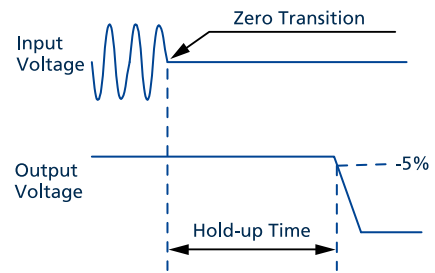

Fig. 7-2: Shut-down behaviour, definitions

8. DC-OK Relay Contact

This feature monitors the output voltage on the output terminals of a running power supply.

Contact closes	As soon as the output voltage reaches typ. 90% of the adjusted output voltage level.
Contact opens	As soon as the output voltage dips more than 10% below the adjusted output voltage. Short dips will be extended to a signal length of 100ms. Dips shorter than 1ms will be ignored.
Switching hysteresis	typ. 1V
Contact ratings	Maximal 60Vdc 0.3A, 30Vdc 1A, 30Vac 0.5A, resistive load Minimal permissible load: 1mA at 5Vdc
Isolation voltage	See dielectric strength table in chapter 19.

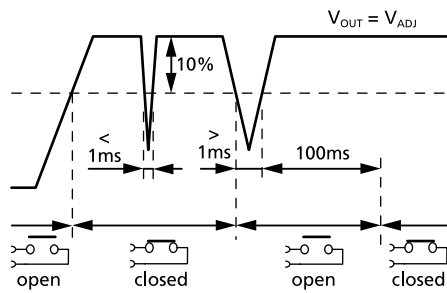

Fig. 8-1: DC-ok relay contact behavior

9. Efficiency and Power Losses

		AC 100V	AC 120V	AC 230V	
Efficiency	typ.	93.6%	94.2%	95.6%	At 24V, 20A
	typ.	93.5%	94.1%	95.5%	At 24V, 24A (PowerBoost)
Average efficiency ^{*)}	typ.	93.2%	93.8%	95%	25% at 5A, 25% at 10A, 25% at 15A, 25% at 20A
Power losses	typ.	2.5W	2.2W	2.2W	At 24V, 0A
	typ.	16W	15W	12.5W	At 24V, 10A
	typ.	32.8W	29.6W	22.1W	At 24V, 20A
	typ.	40W	36.1W	27.1W	At 24V, 24A (PowerBoost)

*) The average efficiency is an assumption for a typical application where the power supply is loaded with 25% of the nominal load for 25% of the time, 50% of the nominal load for another 25% of the time, 75% of the nominal load for another 25% of the time and with 100% of the nominal load for the rest of the time.

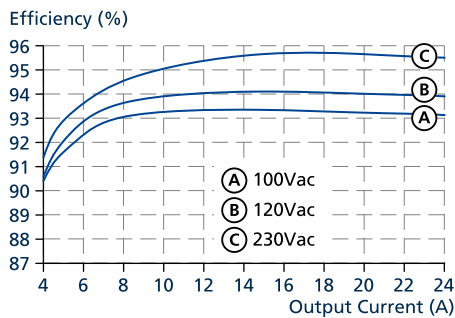

Fig. 9-1: Efficiency vs. output current at 24V, typ.

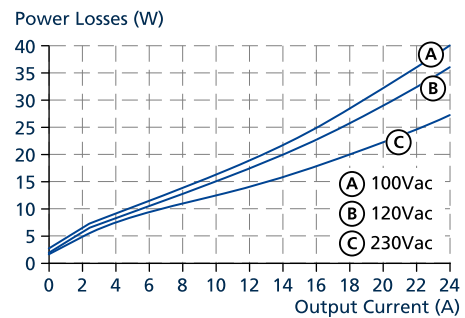

Fig. 9-2: Losses vs. output current at 24V, typ.

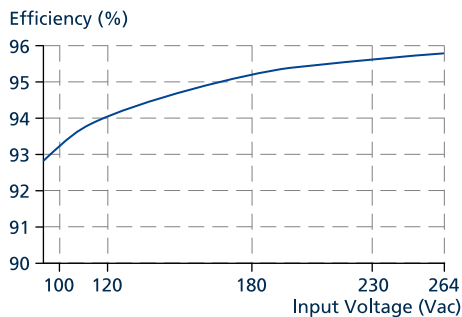

Fig. 9-3: Efficiency vs. input voltage at 24V, 20A, typ.

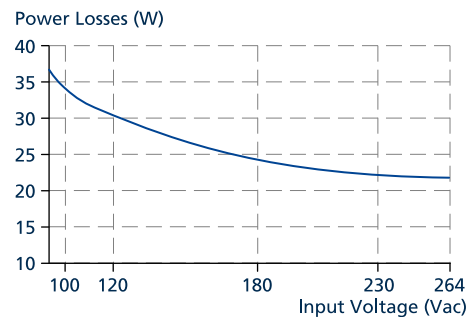

Fig. 9-4: Losses vs. input voltage at 24V, 20A, typ.

10. Lifetime Expectancy

The Lifetime expectancy shown in the table indicates the minimum operating hours (service life) and is determined by the lifetime expectancy of the built-in electrolytic capacitors. Lifetime expectancy is specified in operational hours and is calculated according to the capacitor's manufacturer specification. The manufacturer of the electrolytic capacitors only guarantees a maximum life of up to 15 years (131 400h). Any number exceeding this value is a calculated theoretical lifetime, which can be used to compare devices.

	AC 100V	AC 120V	AC 230V	
Lifetime expectancy	123 000h	149 000h	173 000h	At 24V, 10A and 40°C
	348 000h	422 000h	488 000h	At 24V, 10A and 25°C
	48 000h	60 000h	94 000h	At 24V, 20A and 40°C
	136 000h	169 000h	265 000h	At 24V, 20A and 25°C
	23 000h	31 000h	54 000h	At 24V, 24A and 40°C
	64 000h	88 000h	152 000h	At 24V, 24A and 25°C

11. MTBF

MTBF stands for **Mean Time Between Failure**, which is calculated according to statistical device failures, and indicates reliability of a device. It is the statistical representation of the likelihood of a unit to fail and does not necessarily represent the life of a product.

The MTBF figure is a statistical representation of the likelihood of a device to fail. A MTBF figure of e.g. 1 000 000h means that statistically one unit will fail every 100 hours if 10 000 units are installed in the field. However, it can not be determined if the failed unit has been running for 50 000h or only for 100h.

For these types of units the MTTF (**Mean Time To Failure**) value is the same value as the MTBF value.

	AC 100V	AC 120V	AC 230V	
MTBF SN 29500, IEC 61709	422 000h	445 000h	590 000h	At 24V, 20A and 40°C
	790 000h	832 000h	1 060 000h	At 24V, 20A and 25°C
MTBF MIL HDBK 217F	186 000h	191 000h	226 000h	At 24V, 20A and 40°C; Ground Benign GB40
	256 000h	263 000h	313 000h	At 24V, 20A and 25°C; Ground Benign GB25
	40 000h	42 000h	50 000h	At 24V, 20A and 40°C; Ground Fixed GF40
	53 000h	55 000h	67 000h	At 24V, 20A and 25°C; Ground Fixed GF25

12. Functional Diagram

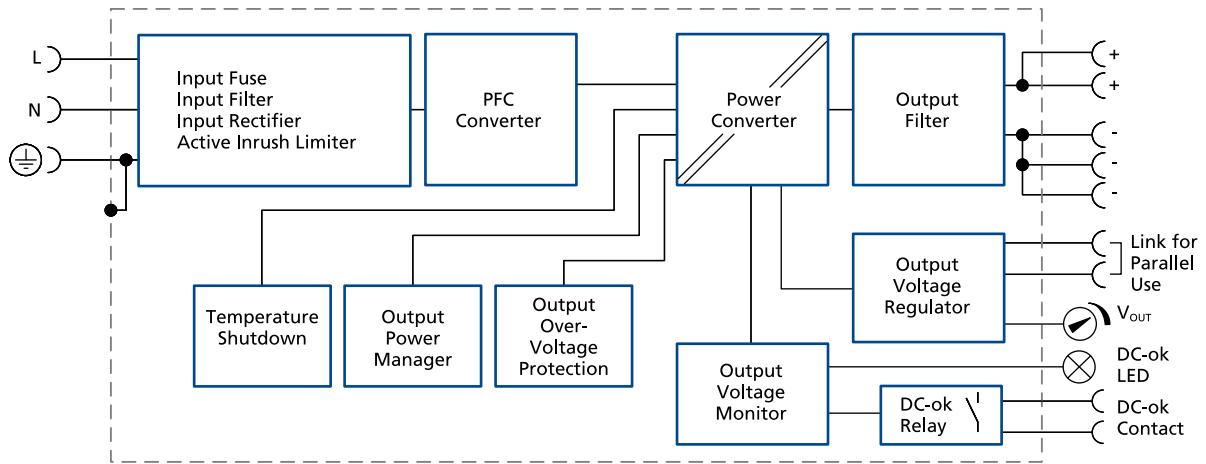

Fig. 12-1: Functional diagram

13. Terminals And Wiring

The terminals are IP20 Finger safe constructed and suitable for field- and factory wiring.

CP20.242	Input	Output	Signal Terminals
Type	Screw terminals	Screw terminals	Push-in terminals
Solid wire	max. 6mm ²	max. 6mm ²	max. 1.5mm ²
Stranded wire	max. 4mm ²	max. 4mm ²	max. 1.5mm ²
American Wire Gauge	AWG 20-10	AWG 20-10	AWG 24-16
Max. wire diameter (including ferrules)	2.8mm	2.8mm	1.6mm
Recommended tightening torque	max. 1Nm	max. 1Nm	-
Wire stripping length	7mm	7mm	7mm
Screwdriver	3.5mm slotted or cross-head No 2	3.5mm slotted or cross-head No 2	3mm slotted to open the spring

Daisy chaining:

Daisy chaining (jumping from one power supply output to the next) is not allowed. Use a separate distribution terminal block as shown in Fig. 13-1.

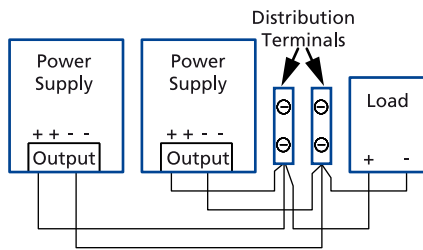

Fig. 13-1: Using distribution terminals

14. Front Side And User Elements

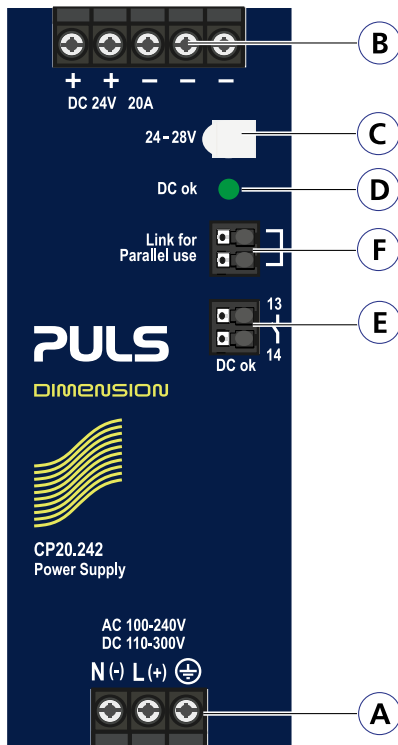

Fig. 14-1: Front side

- A Input Terminals**
 - N, L Line input
 - ⊕ PE (Protective Earth) input
- B Output Terminals**
 - Two identical (+) poles and three identical (-) poles
 - (+) Positive output
 - (-) Negative output (return)
- C Output Voltage Potentiometer**
 - Open the flap to adjust the output voltage. Factory set.: 24.1V
- D DC-OK LED (green)**
 - On, when the output voltage is >90% of the adjusted output voltage.
- E DC-OK Relay Contact**
 - The DC-OK relay contact is synchronized with the DC-OK LED.
 - See chapter 8 for details.
- F "Parallel Use" "Single Use" Link**
 - Link the two terminal poles when power supplies are connected in parallel. In order to achieve a sharing of the load current between the individual power supplies, the "parallel use" regulates the output voltage in such a manner that the voltage at no load is approx. 4% higher than at nominal load. See also chapter 24.6.

15. EMC

The EMC behavior of the device is designed for applications in industrial environment as well as in residential, commercial and light industry environments. The output is allowed to be grounded or floating.

Without additional measures to reduce the conducted emissions on the output (e.g. by using a filter), the device is not suited to supply a local DC power network in residential, commercial and light-industrial environments. No restrictions apply for local DC power networks in industrial environments.

EMC Immunity	According to generic standards: EN 61000-6-1, EN 61000-6-2, EN 61000-6-3 and EN 61000-6-4			
Electrostatic discharge	EN 61000-4-2	Contact discharge	8kV	Criterion A
		Air discharge	15kV	Criterion A
Electromagnetic RF field	EN 61000-4-3	80MHz - 2.7GHz	20V/m	Criterion A
Fast transients (Burst)	EN 61000-4-4	Input lines	4kV	Criterion A
		Output lines	2kV	Criterion A
		Signal lines (coupling clamp)	2kV	Criterion A
Surge voltage on input	EN 61000-4-5	L → N	2kV	Criterion A
		L → PE, N → PE	2kV	Criterion A
Surge voltage on output	EN 61000-4-5	(+) → (-)	1kV	Criterion A
		(+) / (-) → PE	2kV	Criterion A
Surge voltage on DC-OK	EN 61000-4-5	DC-OK signal → PE	1kV	Criterion A
Conducted disturbance	EN 61000-4-6	0.15 - 80MHz	20V	Criterion A
Mains voltage dips	EN 61000-4-11	0% of 100Vac	0Vac, 20ms	Criterion A
		40% of 100Vac	40Vac, 200ms	Criterion C
		70% of 100Vac	70Vac, 500ms	Criterion A
		0% of 200Vac	0Vac, 20ms	Criterion A
		40% of 200Vac	80Vac, 200ms	Criterion A
		70% of 200Vac	140Vac, 500ms	Criterion A
Voltage interruptions	EN 61000-4-11	0% of 200Vac (=0V)	5000ms	Criterion C
Powerful transients	VDE 0160	Over entire load range	750V, 0.3ms	Criterion A

Performance criterions:

A: The device shows normal operation behavior within the defined limits.

C: Temporary loss of function is possible. The device may shut-down and restarts by itself. No damage or hazards for the device will occur.

EMC Emission

Conducted emission input lines	EN 55011, EN 55032, FCC Part 15, CISPR 11, CISPR 32	Class B
Radiated emission	EN 55011, EN 55032	Class B
Harmonic input current (PFC)	EN 61000-3-2	Fulfilled for Class A equipment Fulfilled for Class C equipment in the load range from 8 to 24A
Voltage fluctuations, flicker	EN 61000-3-3	Fulfilled

This device complies with FCC Part 15 rules.

Operation is subjected to following two conditions: (1) this device may not cause harmful interference, and (2) this device must accept any interference received, including interference that may cause undesired operation.

Switching Frequencies

PFC converter	100kHz	Fixed frequency
Main converter	80kHz to 140kHz	Output load dependent
Auxiliary converter	60kHz	Fixed frequency

16. Environment

Operational temperature	-25°C to +70°C	The operational temperature is the same as the ambient or surrounding temperature. It is defined as the air temperature 2cm below the device.
Storage temperature	-40°C to +85°C	For storage and transportation
Output derating	12W/K 1.33A/1000m or 5K/1000m The derating is not hardware controlled. The user has to take care by himself to stay below the derated current limits in order not to overload the unit.	Between +60°C and +70°C For altitudes >2000m, see Fig. 16-2
Humidity	5 to 95% r.h.	According to IEC 60068-2-30
Atmospheric pressure	110-47kPa	See Fig. 16-2 for details
Altitude	Up to 5000m	See Fig. 16-2 for details
Over-voltage category	III II	According to IEC 60664-1 for altitudes <2000m According to IEC 60664-1 for altitudes >2000m
Degree of pollution	2	According to IEC 62477-1, not conductive
Vibration sinusoidal	2-17.8Hz: ±1.6mm 17.8-500Hz: 2g 2 hours / axis	According to IEC 60068-2-6
Shock	30g 6ms, 20g 11ms 3 bumps / direction, 18 bumps in total Shock and vibration is tested in combination with DIN rails EN 60715 with a height of 15mm and a thickness of 1.3mm and standard orientation.	According to IEC 60068-2-27
Audible noise	Some audible noise may be emitted from the power supply during no load, overload or short circuit.	

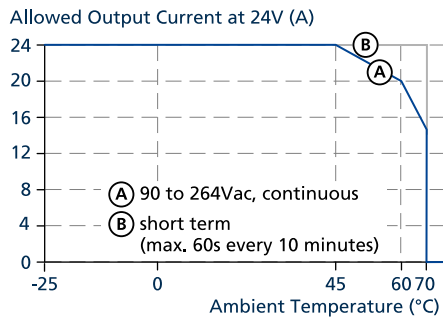

Fig. 16-1: Output current vs. ambient temp.
($I_{nom} = 20A$; I_{out} with PowerBoost = 24A)

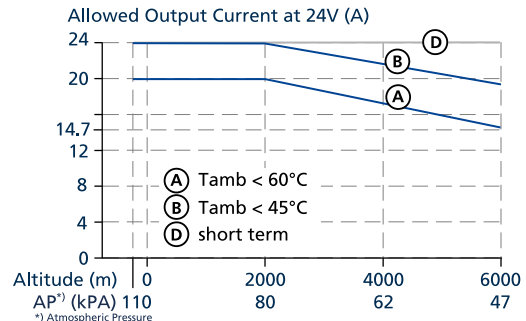

Fig. 16-2: Output current vs. altitude

17. Protection Features

Output over-voltage protection	typ. 30.5Vdc max. 32Vdc	The output shuts down and automatically attempts to restart for three times. If after the third time the restart still fails, the output is switched off permanently until the line input is disconnected for a second.
Degree of protection Penetration protection	IP20 >5mm	EN/IEC 60529 E.g. screws, small parts
Over-temperature protection	Included	Output shut-down with automatic restart. Temperature sensors are installed on critical components inside the unit and turn the unit off in safety critical situations, which can happen e.g. when ambient temperature is too high, ventilation is obstructed or the derating requirements are not followed. There is no correlation between the operating temperature and turn-off temperature since this is dependent on input voltage, load and installation methods.
Input transient protection	MOV (Metal Oxide Varistor)	For protection values see chapter (EMC).
Internal input fuse	Included	Not user replaceable slow-blow high-braking capacity fuse

18. Safety Features

Class of protection	I	PE (Protective Earth) connection required According to IEC 61140
Isolation resistance	>500MΩ	At delivered condition between input and output, measured with 500Vdc
	>500MΩ	At delivered condition between input and PE, measured with 500Vdc
	>500MΩ	At delivered condition between output and PE, measured with 500Vdc
	>500MΩ	At delivered condition between output and DC-OK contacts, measured with 500Vdc
PE resistance	<0.1Ω	Resistance between PE terminal and the housing in the area of the DIN rail mounting bracket.
Touch current (leakage current)	typ. 0.12mA / 0.31mA	At 100Vac, 50Hz, TN-, TT-mains / IT-mains
	typ. 0.18mA / 0.45mA	At 120Vac, 60Hz, TN-, TT-mains / IT-mains
	typ. 0.3mA / 0.76mA	At 230Vac, 50Hz, TN-, TT-mains / IT-mains
	max. 0.16mA / 0.38mA	At 110Vac, 50Hz, TN-, TT-mains / IT-mains
	max. 0.23mA / 0.55mA	At 132Vac, 60Hz, TN-, TT-mains / IT-mains
	max. 0.39mA / 0.94mA	At 264Vac, 50Hz, TN-, TT-mains / IT-mains

19. Dielectric Strength

The output voltage is floating and has no ohmic connection to the ground.

The output is insulated to the input by a double or reinforced insulation.

Type and routine tests are conducted by the manufacturer. Field tests may be conducted in the field using the appropriate test equipment which applies the voltage with a slow ramp (2s up and 2s down). Connect all input-terminals together as well as all output poles before conducting the test. When testing, set the cut-off current settings to the value in the table below.

It is recommended that either the (+) pole, the (-) pole shall be connected to the protective earth system. This helps to avoid situations in which a load starts unexpectedly or can not be switched off when unnoticed earth faults occur.

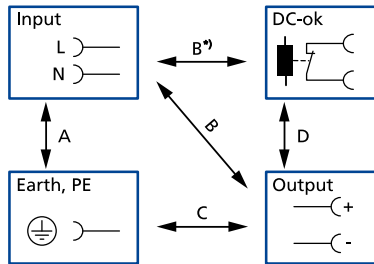



Fig. 19-1: Dielectric strength





		A	B	C	D
Type test	60s	2500Vac	3000Vac	1000Vac	500Vac
Factory test	5s	2500Vac	2500Vac	500Vac	500Vac
Field test	5s	2000Vac	2000Vac	500Vac	500Vac
Field test cut-off current settings		>10mA	>10mA	>20mA	>1mA

- B*) When testing input to DC-OK ensure that the max. voltage between DC-OK and the output is not exceeded (column D). We recommend connecting DC-OK pins and the output pins together when performing the test.

20. Approved, Fulfilled or Tested Standards

IEC 62368	CB Report	CB Scheme Certificate IEC 62368-1 - Audio/video, information and communication technology equipment - Safety requirements Output safety level: ES1
IEC 61010	CB Report	CB Scheme Certificate IEC 61010-2-201 - Electrical Equipment for Measurement, Control and Laboratory Use - Particular requirements for control equipment
UL 61010		UL Certificate Listed equipment for category NMTR - UL 61010-2-201 - Electrical equipment for measurement, control and laboratory use - Particular requirements for control equipment Applicable for US and Canada E-File: E198865
Semi F47	SEMI F47	Test Report Voltage Sag Immunity for Semiconductor Processing Equipment Tested for AC 208V L-L or L-N mains voltages, nominal output voltage and nominal output load
IEC 60068-2-60	Corrosion IEC 60068-2-60 Method 4 ✓	Manufacturer's Declaration (Online Document) Environmental Tests, Flowing Mixed Gas Corrosion Test Test: Ke - Method 4 H2S: 10ppb NO2: 200ppb Cl2: 10ppb SO2: 200ppb Test Duration: 3 weeks, which simulates a service life of at least 10 years.
ISA-71.04-1985	Corrosion G3-ISA-71.04 ✓	Manufacturer's Declaration (Online Document) Airborne Contaminants Corrosion Test Severity Level: G3 Harsh H2S: 100ppb NOx: 1250ppb Cl2: 20ppb SO2: 300ppb Test Duration: 3 weeks, which simulates a service life of at least 10 years
VDMA 24364	LABS VDMA 24364-C1-L/W	Paint Wetting Impairment Substances Test (or LABS-Test) Tested for Zone 2 and Test Class C1 according to VDMA 24364-C1-L/W for solvents and water-based paints

21. Regulatory Product Compliance

EU Declaration of Conformity		<p>The CE mark indicates conformance with the European</p> <ul style="list-style-type: none"> - EMC directive - Low-voltage directive (LVD) - RoHS directive
WEEE Regulation		<p>Manufacturer's Declaration EU Directive on Waste Electrical and Electronic Equipment Registered in Germany as business to business (B2B) products. EU Directive 2012/19/EU</p>
REACH Regulation		<p>Manufacturer's Declaration EU Regulation regarding the Registration, Evaluation, Authorization and Restriction of Chemicals EU Regulation 1907/2006</p>
RoHS-China		<p>Manufacturer's Statement Administrative Measures for the Restriction of the Use of Hazardous Substances in Electrical and Electronic Products 25 years</p>
KC		<p>KC Registration Korean - Registration of Broadcasting and Communication Equipment KOSHA - Korea Occupational Safety and Health Agency Registration No. R-R-PUG-CP20_242</p>

22. Physical Dimensions And Weight

Width	48mm
Height	124mm
Depth	127mm
	The DIN rail depth must be added to the unit depth to calculate the total required installation depth.
Weight	830g
DIN rail	Use 35mm DIN rails according to EN 60715 or EN 50022 with a height of 7.5 or 15mm.
Housing material	Body: Aluminium alloy Cover: Zinc-plated steel
Installation clearances	See chapter 2.
Penetration protection	Small parts like screws, nuts, etc. with a diameter larger than 5mm

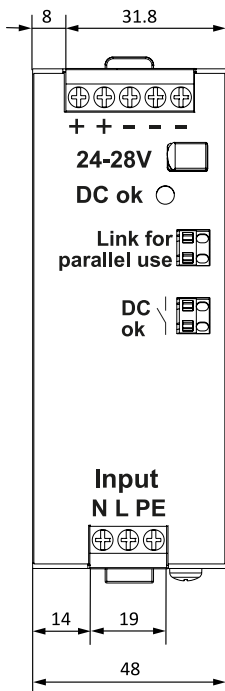

Fig. 22-1: Front view

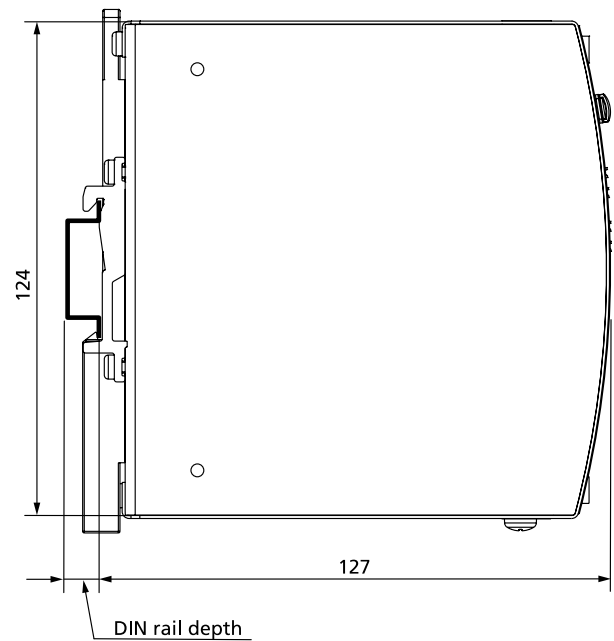

Fig. 22-2: Side view

All dimensions in mm unless otherwise noted.

23. Accessories

23.1. ZM10.WALL - WALL/PANEL MOUNT BRACKET

This bracket is used to mount the devices on a wall/panel without utilizing the DIN rail. The bracket can be mounted without detaching the DIN rail brackets from the power supply.

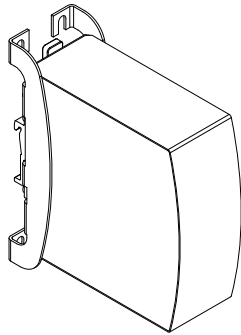

Fig. 23-1: Isometric view

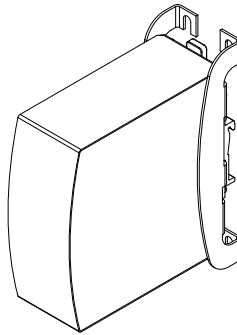

Fig. 23-2: Isometric view

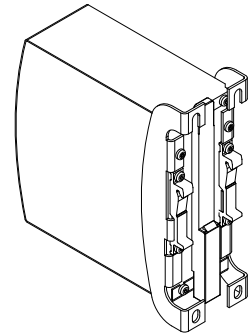

Fig. 23-3: Isometric view

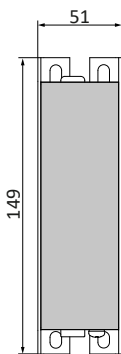

Fig. 23-4: Wall/panel mounting, front view

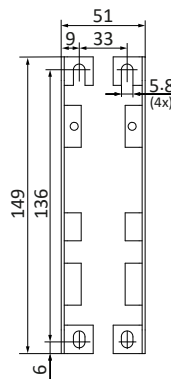

Fig. 23-5: Hole pattern for wall mounting

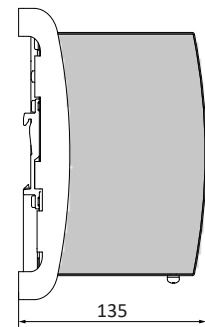

Fig. 23-6: Wall/panel mounting, side view

All dimensions in mm unless otherwise noted.

23.2. UF20.241 - BUFFER MODULE



The UF20.241 buffer module is a supplementary device for DC 24V power supplies. It delivers power to bridge typical mains failures or extends the hold-up time after the AC power is turned off.

When the power supply provides a sufficient voltage, the buffer module stores energy in the integrated electrolytic capacitors. When the mains voltage is lost, the stored energy is released to the DC-bus in a regulated process.

The buffer module can be added in parallel to the load circuit at any given point and does not require any control wiring.

One buffer module can deliver 20A additional current and can be added in parallel to increase the output ampacity or the hold-up time.

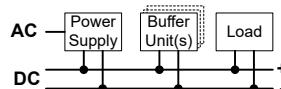

All parameters are specified at 24V, 20A, 230Vac, 25°C ambient and after a 5 minutes run-in time unless otherwise noted.

23.3. YR40.241 - REDUNDANCY MODULE



The YR40.241 is a dual redundancy module, which can be used to build 1+1 or N+1 redundant systems.

The device is equipped with two 20A nominal input channels, which are individually decoupled by utilizing MOSFET technology. The output can be loaded with a nominal 40A continuous current.

Using MOSFETs instead of diodes reduces heat generation, losses and voltage drop between input and output. Due to these advantages, the unit is very narrow and only requires 36mm width on the DIN rail.

The device does not require an additional auxiliary voltage and is self-powered even in case of a short circuit across the output. A feature of this redundancy module is a special circuit, which keeps the losses and temperature low, even at overload and short circuit conditions up to 65A continuous current.

See chapter 24.4 for wiring information.

23.4. YR40.242 – REDUNDANCY MODULE



The YR40.242 is a dual redundancy module, which can be used to build 1+1 or N+1 redundant systems.

The device is equipped with two 20A nominal input channels, which are individually decoupled by utilizing MOSFET technology. The output can be loaded with a nominal 40A continuous current.

Using MOSFETs instead of diodes reduces heat generation, losses and voltage drop between input and output. Due to these advantages, the unit is very narrow and only requires 36mm width on the DIN rail.

The device does not require an additional auxiliary voltage and is self-powered even in case of a short circuit across the output. It requires suitable power supplies on the input, where the sum of the continuous short circuit current stays below 26A. This is typically achieved when the power supplies are featured with an intermittent overload behavior (Hiccup^{PLUS} Mode).

See chapter 24.4 for wiring information.

23.5. YR40.245 - REDUNDANCY MODULE



The YR40.245 is a 40A single channel redundancy module, which is equipped with a plug connector on the output. The plug connector allows replacing the power supply or the redundancy module while the system is running. The plug connector avoids that the output wires can touch and short the load circuit.

The input of the device is decoupled by utilizing MOSFET technology.

Using MOSFETs instead of diodes reduces heat generation, losses and voltage drop between input and output. Due to these advantages, the unit is very narrow and only requires 46mm width on the DIN rail.

The device does not require an additional auxiliary voltage and is self-powered even in case of a short circuit across the output. It requires a suitable power supply on the input, where the continuous short circuit current stays below 22A. This is typically achieved when the power supply is featured with an intermittent overload behavior (Hiccup^{PLUS} Mode).

See chapter 24.4 for wiring information.

24. Application Notes

24.1. PEAK CURRENT CAPABILITY

The device can deliver peak currents (up to several milliseconds) which are higher than the specified short term currents. This helps to start current demanding loads. Solenoids, contactors and pneumatic modules often have a steady state coil and a pick-up coil. The inrush current demand of the pick-up coil is several times higher than the steady-state current and usually exceeds the nominal output current. The same situation applies when starting a capacitive load.

The peak current capability also ensures the safe operation of subsequent circuit breakers of load circuits. The load branches are often individually protected with circuit breakers or fuses. In case of a short or an overload in one branch circuit, the fuse or circuit breaker need a certain amount of over-current to open in a timely manner. This avoids voltage loss in adjacent circuits.

The extra current (peak current) is supplied by the power converter and the built-in large sized output capacitors of the power supply. The capacitors get discharged during such an event, which causes a voltage dip on the output. The following examples show typical voltage dips for resistive loads:

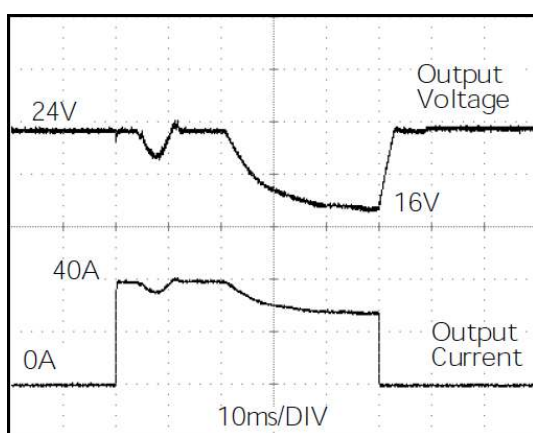

Fig. 24-1: 40A peak current for 50ms, typ. (2x the nominal current)

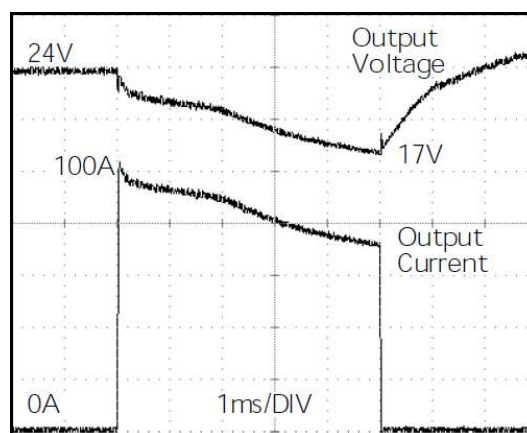

Fig. 24-2: 100A peak current for 5ms, typ. (5x the nominal current)

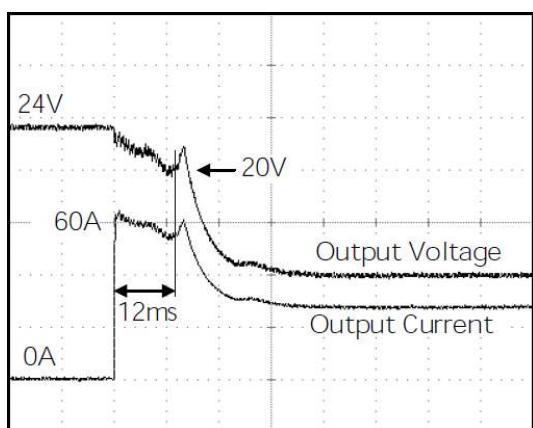

Fig. 24-3: 60A peak current for 12ms, typ. (3x the nominal current)

Please note: The DC-OK relay triggers when the voltage dips more than 10% for longer than 1ms.

Peak current voltage dips	typ.	From 24V to 16V	at 40A for 50ms, resistive load
	typ.	From 24V to 21V	at 100A for 2ms, resistive load
	typ.	From 24V to 17V	at 100A for 5ms, resistive load

24.2. OUTPUT CIRCUIT BREAKERS

Standard miniature circuit breakers (MCB's or UL 1077 circuit breakers) are commonly used for AC-supply systems and may also be used on 24V branches.

MCB's are designed to protect wires and circuits. If the ampere value and the characteristics of the MCB are adapted to the wire size that is used, the wiring is considered as thermally safe regardless of whether the MCB opens or not.

To avoid voltage dips and under-voltage situations in adjacent 24V branches which are supplied by the same source, a fast (magnetic) tripping of the MCB is desired. A quick shutdown within 10ms is necessary corresponding roughly to the ride-through time of PLC's. This requires power supplies with high current reserves and large output capacitors. Furthermore, the impedance of the faulty branch must be sufficiently small in order for the current to actually flow. The best current reserve in the power supply does not help if Ohm's law does not permit current flow. The following table has typical test results showing which B- and C-Characteristic MCBs magnetically trip depending on the wire cross section and wire length.

Maximal wire length *) for a fast (magnetic) tripping:

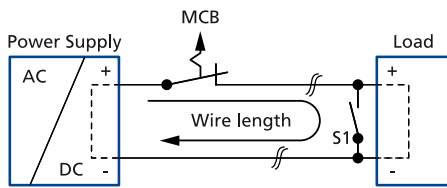

S1... Fault simulation switch

Fig. 24-4: Test circuit

	0.75mm ²	1.0mm ²	1.5mm ²	2.5mm ²
C-2A	31m	37m	63m	98m
C-3A	28m	34m	51m	78m
C-4A	18m	25m	38m	58m
C-6A	9m	11m	18m	26m
C-8A	6m	7m	12m	14m
C-10A	4m	6m	11m	13m
C-13A	2m	2m	4m	7m
B-6A	23m	28m	46m	66m
B-10A	11m	14m	19m	32m
B-13A	7m	11m	16m	29m
B-16A	5m	6m	8m	15m
B-20A	1m	1m	2m	4m
B-25A	-	-	-	1m

*) Don't forget to consider twice the distance to the load (or cable length) when calculating the total wire length (+ and - wire).

24.3. PARALLEL USE TO INCREASE OUTPUT POWER

Power supplies can be paralleled to increase the output power. The output voltage of all devices shall be adjusted to the same value ($\pm 100\text{mV}$) in "Single Use" mode with the same load conditions on all units, or the units can be left with the factory settings. After the adjustments, set the unit to "Parallel Use" mode, in order to achieve load sharing. The "Parallel Use" mode regulates the output voltage in such a manner that the voltage at no load is approx. 4% higher than at nominal load. See also chapter 6.

The ambient temperature is not allowed to exceed $+60^{\circ}\text{C}$.

If more than three units are connected in parallel, a fuse or circuit breaker with a rating of 30A or 32A is required on each output. Alternatively, a diode or redundancy module can also be utilized.

Energize all units at the same time. It also might be necessary to cycle the input power (turn-off for at least five seconds), if the output was in overload or short circuits and the required output current is higher than the current of one unit.

Keep an installation clearance of 15mm (left / right) between two devices and avoid installing devices on top of each other. Do not use devices in parallel in mounting orientations other than the standard mounting orientation or in any other condition where a reduction of the output current is required (e.g. altitude).

Pay attention that leakage current, EMI, inrush current will increase when using multiple devices.

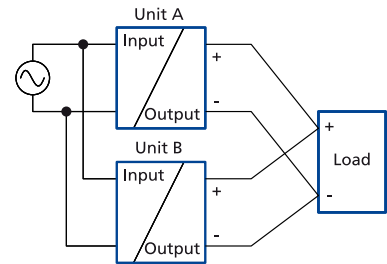

24.4. PARALLEL USE FOR REDUNDANCY

Please note that there are variants with built-in redundancy are available in the CP20 series. Check CP20.241-Rx units.

1+1 Redundancy:

Power supplies can be paralleled for redundancy to gain higher system availability. Redundant systems require a certain amount of extra power to support the load in case one device fails. The simplest way is to put two devices in parallel. This is called a 1+1 redundancy. In case one device fails, the other one is automatically able to support the load current without any interruption. It is essential to use a redundancy module to decouple devices from each other. This prevents that the defective unit becomes a load for the other device and the output voltage cannot be maintained anymore.

1+1 redundancy allows ambient temperatures up to +70°C.

Pay attention that leakage current, EMI, inrush current, harmonics will increase when using multiple devices.

Recommendations for building redundant power systems:

- Use separate input fuses for each device.
- Use separate mains systems for each device whenever it is possible.
- Monitor the individual devices. Therefore, use the DC-OK signal of the device.
- It is desirable to set the output voltages of all devices to the same value ($\pm 100\text{mV}$) or leave it at the factory setting.
- Set the devices into "Parallel Use" mode.

N+1 Redundancy:

Redundant systems for a higher power demand are usually built in a N+1 method. E.g. four devices, each rated for 20A are paralleled to build a 60A redundant system.

Pay attention that leakage current, EMI, inrush current, harmonics will increase when using multiple devices.

Keep an installation clearance of 15mm (left / right) between two devices and avoid installing the devices on top of each other.

Do not use devices in parallel in mounting orientations other than the standard mounting orientation or in any other condition, where a reduction of the output current is required.

For N+1 redundancy the ambient temperature is not allowed to exceed +60°C.

Wiring examples for 1+1 redundancy and N+1 redundancy:

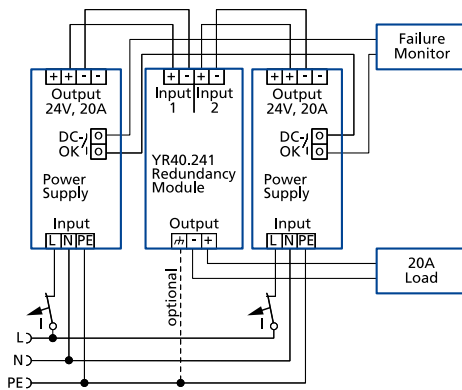

Fig. 24-5: 1+1 Redundant configuration for 20A load current with a dual redundancy module

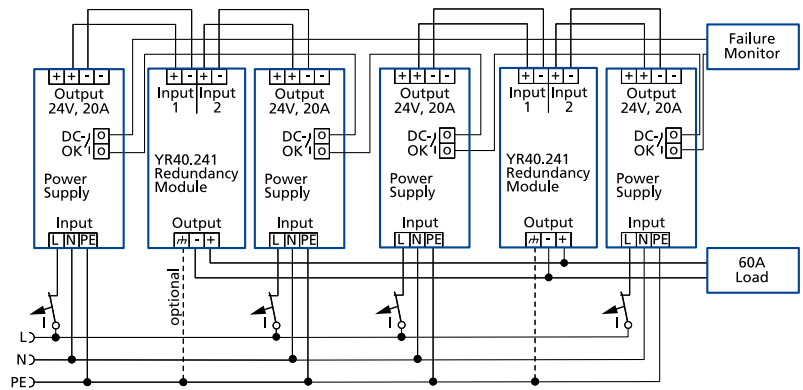

Fig. 24-6: N+1 Redundant configuration for 60A load current with multiple devices and redundancy modules

Alternatively, the YR40.242 redundancy module can be used but has the input and output terminals reversed.

Alternatively, the YR40.242 redundancy module can be used but has the input and output terminals reversed.

24.5. SERIES OPERATION

Power supplies of the same type can be connected in series for higher output voltages. It is possible to connect as many units in series as needed, providing the sum of the output voltage does not exceed 150Vdc. Voltages with a potential above 60Vdc must be installed with a protection against touching.

Earthing of the output is required when the sum of the output voltage is above 60Vdc.

Avoid return voltage (e.g. from a decelerating motor or battery) which is applied to the output terminals.

Keep an installation clearance of 15mm (left / right) between two power supplies and avoid installing the power supplies on top of each other. Do not use power supplies in series in mounting orientations other than the standard mounting orientation (terminals on the bottom of the unit).

Pay attention that leakage current, EMI, inrush current, harmonics will increase when using multiple power supplies.

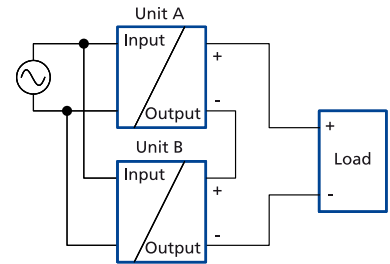

24.6. CHARGING OF BATTERIES

The power supply can be used to charge lead-acid or maintenance free batteries. Two 12V SLA or VRLA batteries are needed in series connection.

Instructions for charging batteries:

- Use only matched batteries when putting 12V types in series.
- Ensure that the ambient temperature of the power supply stays below +40°C.
- Use a 32A or 30A circuit breaker (or blocking diode) between the power supply and the battery.
- Ensure that the output current of the power supply is below the allowed charging current of the battery.
- The return current to the power supply (battery discharge current) is typ. 3.5mA when the power supply is switched off (except in case a blocking diode is utilized).
- Set the device into "Parallel Use" mode and adjust the output voltage, measured at no load and at the battery end of the cable, very precisely to the end-of-charge voltage.

End-of-charge voltage	27.8V	27.5V	27.15V	26.8V
Battery temperature	10°C	20°C	30°C	40°C

24.7. TWO PHASE OPERATION

The power supply can also be operated on two phases of a three-phase-system. Such a phase-to-phase connection is allowed as long as the supplying voltage is below 240V^{+10%}.

Ensure that the wire, which is connected to the N-terminal, is appropriately fused. The maximum allowed voltage between a Phase and the PE must be below 300Vac.

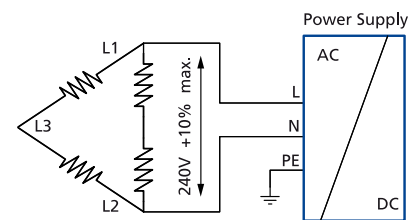

24.8. USE IN A TIGHTLY SEALED ENCLOSURE

When the power supply is installed in a tightly sealed enclosure, the temperature inside the enclosure will be higher than outside. In such situations, the inside temperature defines the ambient temperature for the power supply.

The power supply is placed in the middle of the box, no other heat producing items are inside the box. The temperature sensor inside the box is placed in the middle of the right side of the power supply with a distance of 1cm. The following measurement results can be used as a reference to estimate the temperature rise inside the enclosure.

	Case A	Case B
Enclosure size	180x180x165mm Rittal Typ IP66 Box PK 9516 100 plastic	180x180x165mm Rittal Typ IP66 Box PK 9516 100 plastic
Input voltage	230Vac	230Vac
Load	24V, 16A; (=80%)	24V, 20A; (=100%)
Temperature inside the box	51.7°C	55.8°C
Temperature outside the box	25.9°C	25.6°C
Temperature rise	25.8K	30.2K

24.9. MOUNTING ORIENTATIONS

Mounting orientations other than input terminals on the bottom and output on the top require a reduction in continuous output power or a limitation in the maximum allowed ambient temperature.

The listed lifetime and MTBF values from this datasheet apply only for the standard mounting orientation.

The following curves give an indication for allowed output currents for altitudes up to 2000m.

A
Standard Orientation

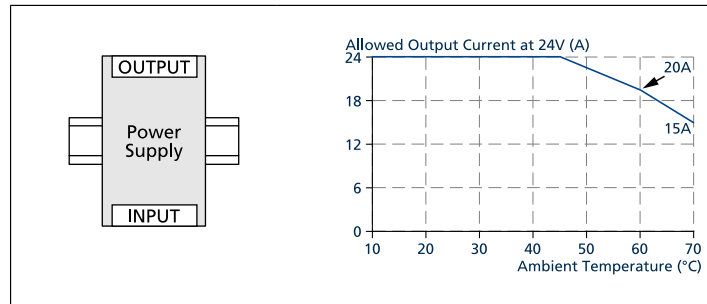

B
Upside down

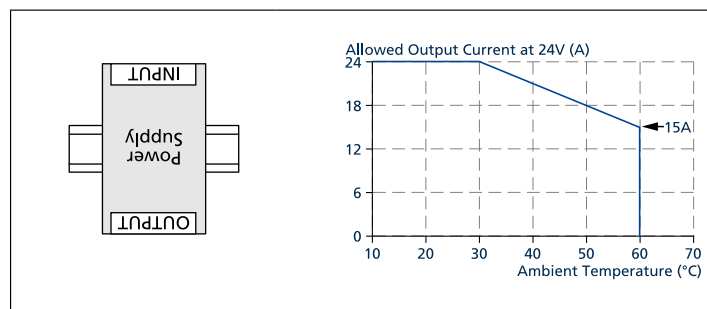

C
Table-top mounting

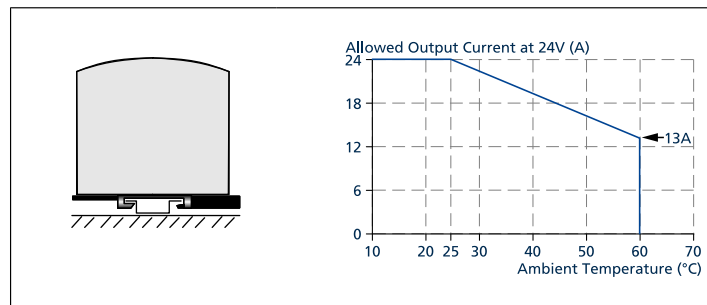

D
Horizontal cw

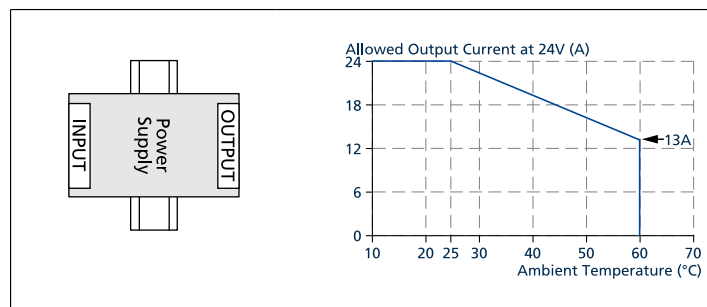

E
Horizontal ccw

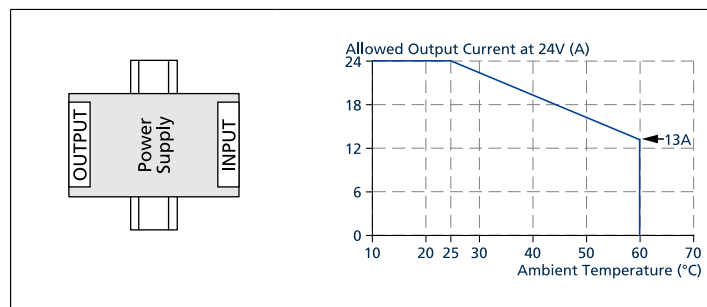

All parameters are specified at 24V, 20A, 230Vac, 25°C ambient and after a 5 minutes run-in time unless otherwise noted.