

# STM32F3 series

## Mainstream 32-bit MCUs

### Releasing your creativity





# Content

<b>F3 inside STM32 family</b> .....	3
10 product series – more than 40 product lines .....	3
Main features and benefits .....	4
<b>An upgraded MCU class</b> .....	5
STM32F3 product lines .....	5
STM32F30X product lines portfolio .....	6
STM32F303 block diagram .....	7
Advanced peripherals .....	7
CCM-SRAM: the Routine Booster .....	7
<b>Digital power line</b> .....	8
STM32F334 portfolio .....	8
STM32F334 block diagram .....	9
Application target .....	9
Complex waveform building and multi-event handling (from HRTIM) - Example .....	9
<b>High precision line</b> .....	10
STM32F373 portfolio .....	10
STM32F373 block diagram .....	10
Application target .....	10
Advanced peripherals .....	10
<b>Low voltage line</b> .....	11
STM32F3X8 portfolio .....	11
Voltage range (Core, I/Os and VddA Analog) .....	11
<b>STM32F3 ecosystem</b> .....	12
STM32 Nucleo portfolio .....	12
STM32 Nucleo expansion boards .....	13
Achieving SIL2/3 with STM32F3 .....	13
STM32 education .....	14
STM32 motor control ecosystem .....	14
STM32 digital power ecosystem .....	14
Find information and support .....	16
ST Community .....	16





# F3 inside STM32 family

By choosing an STM32 microcontroller for your embedded application, you gain from our market-leading expertise in MCU architecture, technology, multi-source manufacturing and long-term supply.

## 10 PRODUCT SERIES – MORE THAN 40 PRODUCT LINES

The STM32 portfolio offers an extraordinary variety of options including ARM® Cortex®-M cores (M0, M0+, M3, M4, and M7), giving developers flexibility to find the perfect match for their application. Particular attention is paid to make it easy to switch from one device to another. The compatibility of binaries combined with the similar pinout assignment, proliferation of hardware IPs and higher-level programming languages greatly facilitates the work of developers.

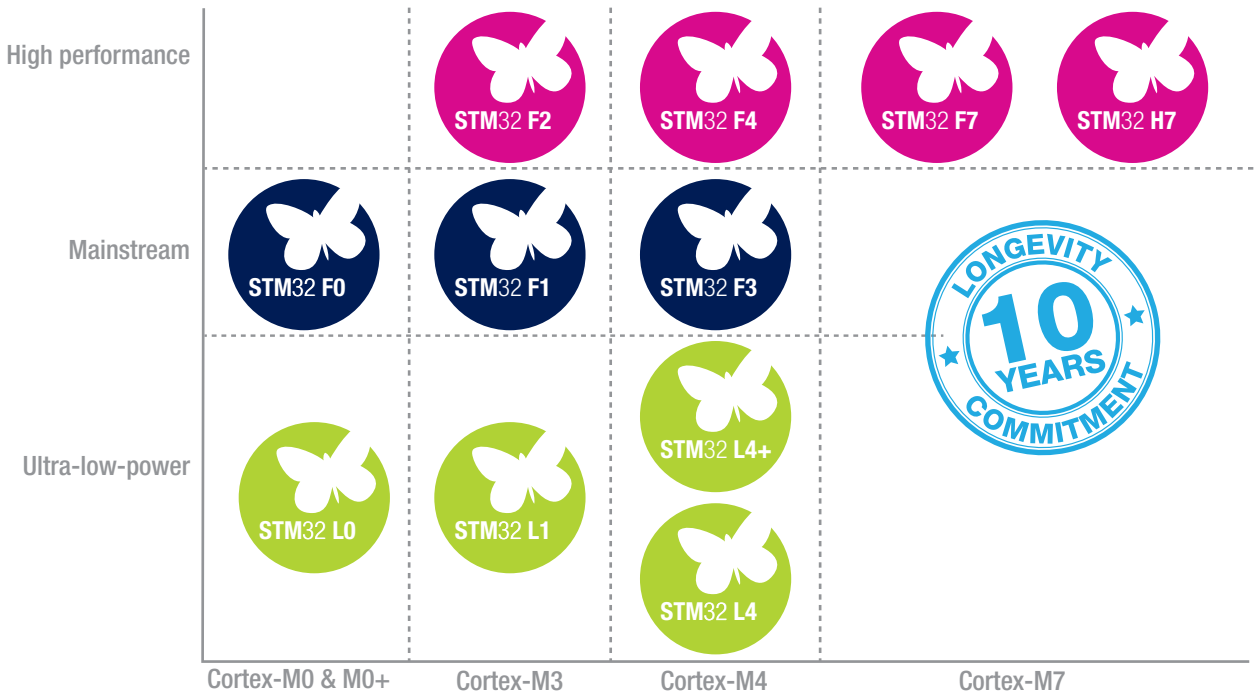

The Mainstream family addresses a large variety of needs found in general-purpose applications.

The STM32 portfolio offers the possibility to boost the performance with more MIPS or better ultra-low power specifications than other microcontroller families. The STM32F3 series is the upgraded class in the Mainstream family thanks to the powerful Cortex-M4 core combined with its advanced digital and analog peripheral set.

The pin compatibility between STM32F1, F0 and F3 series makes navigation across the board extremely convenient

The F3 series extends the scope of ST's STM32 family by allowing designers to tackle mixed-signal control applications. The STM32F3 series is optimized for efficient handling and processing of mixed signals in applications such as three-phase motor controls, biometrics and industrial sensors, sonars and audio as well as digital power applications including power supplies, lighting, and welding.

# STM32F3 key benefits

## MAIN FEATURES AND BENEFITS

Features	Benefits
<p><b>Performance and architecture</b></p> <ul style="list-style-type: none"> <li>• 72 MHz / 63 DMIPS (from Flash) or 90 DMIPS (from CCM-SRAM)</li> <li>• ARM® Cortex®-M4 with single cycle DSP MAC and floating point unit (FPU)</li> <li>• Routine Booster (CCM-SRAM for Core Coupled Memory-SRAM): SRAM mapped to the instruction bus</li> <li>• SRAM with parity bit</li> <li>• Memory Protection Unit (MPU)</li> <li>• Embedded Trace Macrocell (ETM)</li> <li>• Interconnect matrix</li> <li>• DMA controllers</li> <li>• Flexible Static Memory Controller (FSMC)</li> </ul>	<ul style="list-style-type: none"> <li>• Boosted execution of control algorithms</li> <li>• Better code efficiency</li> <li>• Fast time to market</li> <li>• Elimination of scaling and saturation</li> <li>• More performance for critical routines with zero wait state execution from safe CCM-SRAM</li> <li>• 100% deterministic execution from CCM-SRAM</li> <li>• Data and code reliability</li> <li>• Advanced debug functions</li> <li>• Peripheral connection flexibility and code size reduction</li> <li>• Large set of external memory accessible up to 36 MHz giving more flexibility</li> <li>• No code size limit</li> </ul>
<p><b>Outstanding power efficiency</b></p> <ul style="list-style-type: none"> <li>• Stop mode down to 6.7 <math>\mu</math>A (typ.)</li> <li>• RTC down to 0.5 <math>\mu</math>A (typ.) in <math>V_{BAT}</math> mode</li> <li>• 2.0 to 3.6 V or 1.8 V <math>\pm</math> 8% power supply range</li> </ul>	<ul style="list-style-type: none"> <li>• Flexibility to reduce power consumption for applications requiring advanced analog peripherals and low-power modes</li> <li>• Ideal for running at low voltages or on a rechargeable battery</li> </ul>
<p><b>Superior and innovative peripherals</b></p> <ul style="list-style-type: none"> <li>• Analog: Fast 12-bit ADC at 5 Msps (0.2 <math>\mu</math>s), Precise 16-bit sigma-delta ADC, Fast and ultra-fast comparators (25 ns), Op amp with PGA (4 gains, 1% accuracy), 12-bit DACs</li> <li>• Up to 18 timers: 16- and 32-bit resolution running up to 144 MHz</li> <li>• Audio: Simplex or full duplex I<sup>2</sup>S interfaces</li> <li>• Large set of communication interfaces including USART (9 Mbit/s), SPI/I<sup>2</sup>S (18 Mbit/s), I<sup>2</sup>C (1 MHz fast mode plus), CAN (1 Mbit/s), and full-speed USB</li> <li>• Cyclic redundancy check (CRC)</li> <li>• Capacitive touch sensing (24 keys)</li> <li>• High-resolution timer (217 ps) with complex waveform builder and multi-event handler</li> </ul>	<ul style="list-style-type: none"> <li>• Mixed signal management within one chip</li> <li>• BOM cost reduction</li> <li>• Simpler PCB design</li> <li>• Reduced MCU layout footprint</li> <li>• Code reliability</li> <li>• Eases digital power conversion</li> <li>• Control loop</li> </ul>
<p><b>STM32 compatibility and scalable portfolio</b></p> <ul style="list-style-type: none"> <li>• Pin compatibility and same API with STM32F0 peripherals</li> <li>• From 16 up to 512 Kbytes of Flash memory</li> <li>• From 32 to 144 pins in QFN, LQFP, BGA, and WLCSP packages</li> <li>• Ambient temperature range: -40 °C to +105 °C (+125 °C junction)</li> </ul>	<ul style="list-style-type: none"> <li>• Eases platform development strategy from Cortex-M0 (F0 series) up to Cortex-M4 (F3 series) cores</li> <li>• Industrial grade</li> </ul>



# An upgraded MCU class

## The STM32F3 family of mixed-signal MCUs with DSP and FPU instructions

The STM32F3 series shakes up the digital signal controller world by combining a 32-bit ARM® Cortex®-M4 core (DSP, FPU) running at 72 MHz with a high number of integrated analog and digital peripherals leading to cost reduction at application level and simplifying application design.

The STM32F3 Series consists of six lines:

- The **STM32F301, STM32F302, STM32F303 lines** are general-purpose MCUs ranging from a basic, cost-efficient peripheral set to devices with more performance and analog functions.
- The **STM32F334 line** includes a versatile high-resolution timer (217 ps) for digital power conversion applications, such as D-SMPS, lighting, welding, solar and wireless charging.
- The **STM32F373 line** with its 16-bit sigma-delta ADC is designed for high-precision measurements in applications such as biometric sensors or smart metering.
- The **STM32F3x8 line** supporting 1.8 V operations.



### STM32F3 PRODUCT LINES

Cortex®-M4 (DSP + FPU) - 72 MHz	 Product line	Flash memory (KB)	RAM (KB)	CCM-SRAM	Power supply	ADC		12-bit DAC	Fast and Ultra Fast Comparators	Op amp (PGA)	Advanced 16-bit PWM Timer	High-Resolution Timer
						12-bit	16-bit					
						<ul style="list-style-type: none"> <li>• Routine booster (CCM)</li> <li>• Interconnect Matrix</li> <li>• DMA</li> <li>• USART, SPI, I<sup>2</sup>C, I<sup>3</sup>S, USB and CAN</li> <li>• 16- and 32-bit timers</li> <li>• HW polynomial CRC</li> <li>• SRAM with Parity check</li> <li>• Low and high speed oscillator</li> <li>• Reset + BOR PVD</li> <li>• RTC</li> <li>• Temperature sensor</li> <li>• Capacitive Touch sensing</li> </ul>	<b>STM32F301 - Access</b> <b>STM32F302 - USB &amp; CAN</b> <b>STM32F303 - Performance</b> <b>STM32F3x4 Digital Power</b> <b>STM32F373 Precision measurement</b> <b>STM32F3x8 1.8 V ± 8%</b>					
32 to 512	16 to 64		2.0 to 3.6 V	Up to 2		1	Up to 4	Up to 2	1			
32 to 512	16 to 80	•	2.0 to 3.6 V	Up to 4		Up to 3	Up to 7	Up to 4	Up to 3			
16 to 64	16	•	2.0 to 3.6 V	2		3	2x Ultra Fast	1	1	•	10ch	
64 to 256	32		2.0 to 3.6 V	1	3	3	2					
64 to 512	16 to 80	•	1.8 V ± 8%	Up to 4		Up to 3	Up to 7	Up to 4	Up to 3			

A flexible interconnect matrix allows autonomous communication between peripherals and saves CPU resources and power consumption.

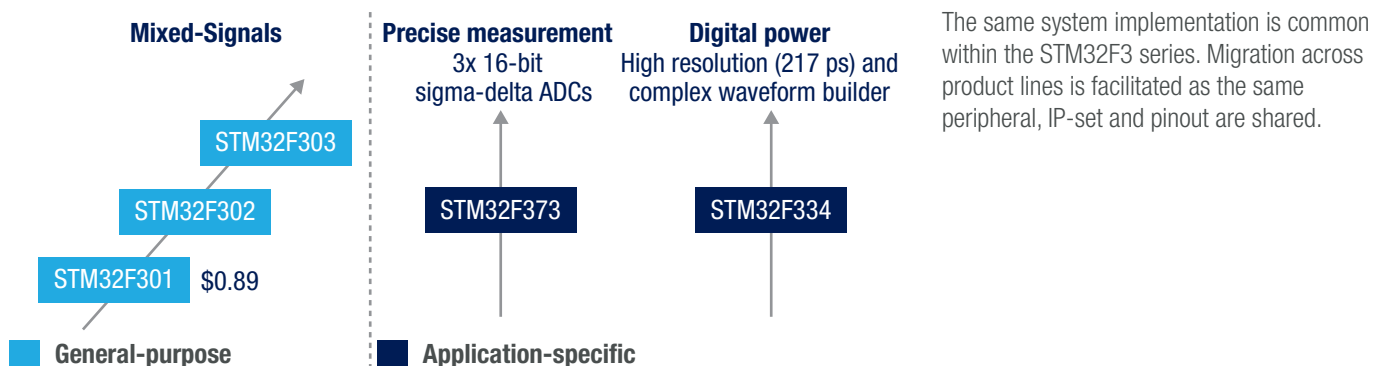

Note: The same devices are found in the STM32F3x8 line and operate at 1.8 V.



# STM32F301 / 2 / 3 line

## General-purpose MCUs ranging from basic to increased performance devices

The STM32F301/2/3 mixed-signal MCUs featuring an ARM® Cortex®-M4 core (DSP, FPU) at 72 MHz are tailored to address general-purpose applications in the continuity of the successful STM32F101/102/103 product lines.

### STM32F30X PRODUCT LINES PORTFOLIO

Flash memory size / RAM size (bytes)

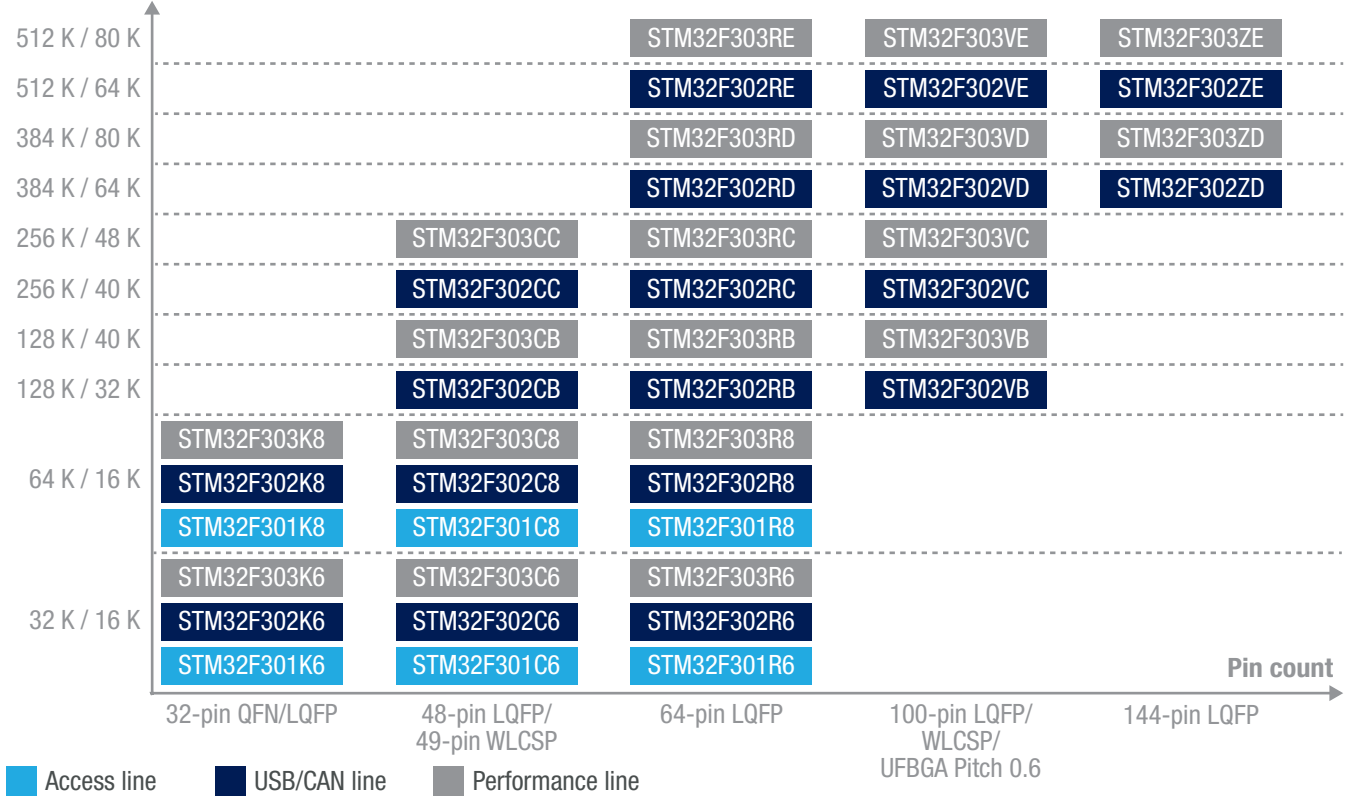

6

- **STM32F301**: STM32 Cortex-M4 entry level. First sub-dollar Cortex-M4 devices with FPU, the STM32F301 access line has from 32 to 64 Kbytes of on-chip Flash and 16 Kbytes of SRAM, offering an easy way to step into Cortex-M4-core-based MCU development.
- The **STM32F302 and STM32F303** MCUs, compatible with, but more powerful than the STM32F103, operate between 2.0 and 3.6 V. They integrate different levels of analog peripherals. The STM32F303 brings the capability to boost the execution of critical routines with its CCM-SRAM.

### TYPICAL CONSUMPTION VALUES ACROSS STM32F3 POWER MODES

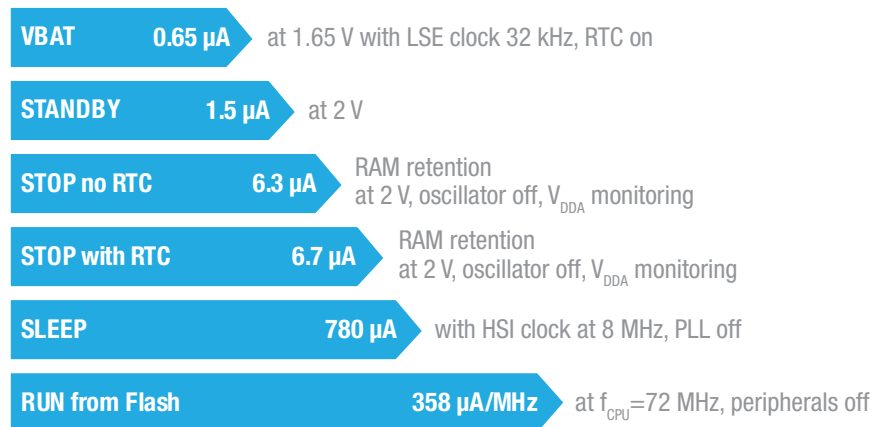

# STM32F303 BLOCK DIAGRAM

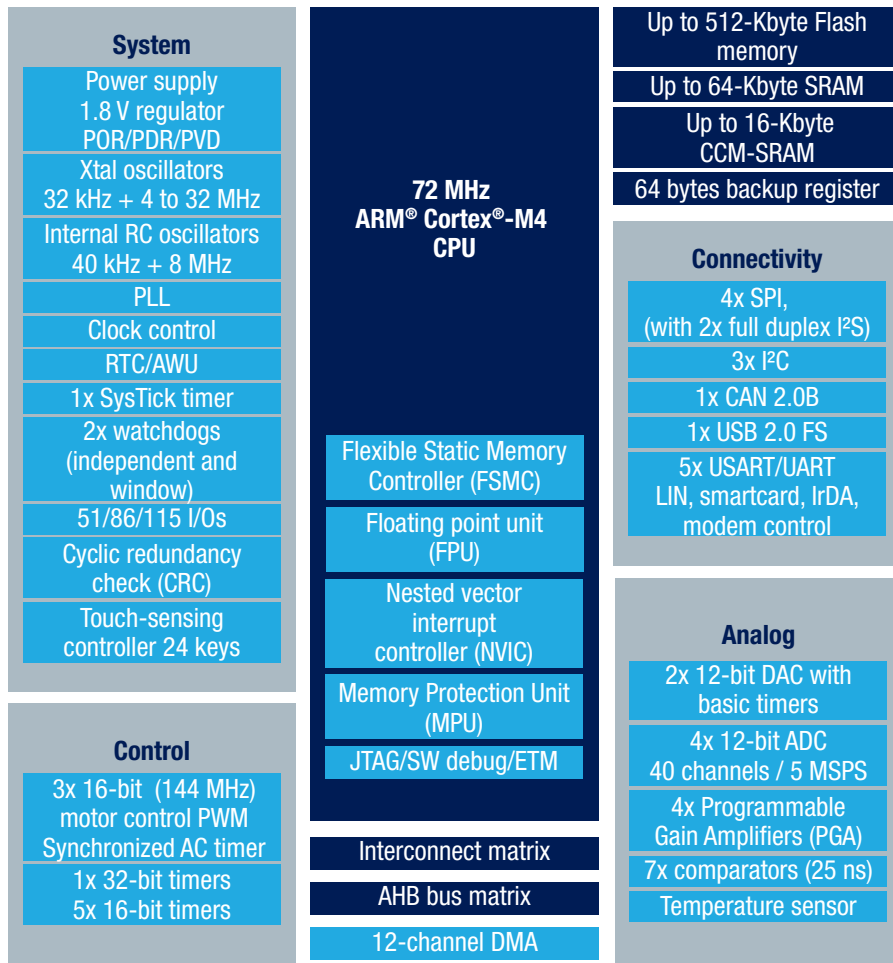

## ADVANCED PERIPHERALS

- Up to seven fast and ultra-fast comparators (down to 25 ns)
- Up to four op amps with programmable gain (PGA) at 1% accuracy
- Up to four ultra-fast 12-bit ADCs with 5 MSPS and 21 ns sampling time (up to 18 MSPS in Interleaved mode)
- Up to three fast 144 MHz motor control timers (resolution < 7 ns)
- SRAM with Parity bit and Polynomial CRC for better reliability
- Fast communication peripherals: 9 Mbits/s USART, 18 Mbits/s SPI, and 1 MHz I<sup>2</sup>C
- Full duplex I<sup>2</sup>S for audio applications
- 5-volt tolerant I/Os (FT, Ftf)

The high mathematical computation brought by the Cortex-M4 core, combined with its rich and advanced analog peripherals set, make STM32F30x devices ideal for control loops such as in motor control applications.



## CCM-SRAM: THE ROUTINE BOOSTER

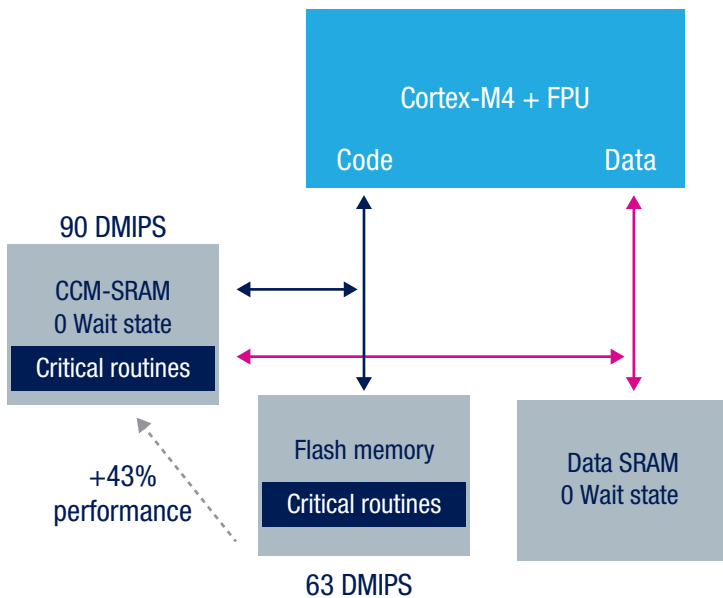

The routine booster (CCM-SRAM) accelerates the execution of critical routines. It consists of an SRAM plugged on both instruction and data buses where code is executed without any wait state, thus providing 43% more performance compared to Flash execution. This 'static cache' offers 90 DMIPS or 245 CoreMark (equivalent to devices with CPU frequency > 100 MHz).



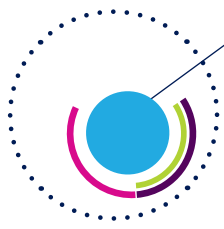

# Digital power line

## The STM32F334 boosts digital power conversion

The STM32F334 product line specifically addresses digital power conversion applications, such as D-SMPS, lighting, welding, inverters for solar systems and wireless chargers, thanks to its agile high-resolution timer (HRTIM) providing 217 ps resolution on all operating modes with embedded powerful waveform generator and event handler. A complete ecosystem has been designed to ease digital power conversion based on STM32F334 devices.

### STM32F334 PORTFOLIO

Flash memory size / RAM size (bytes)

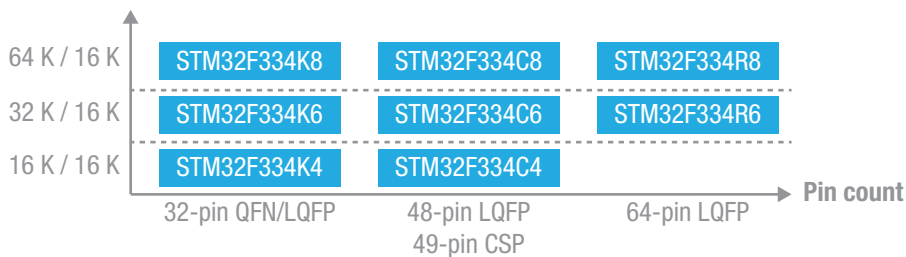

Developing with the STM32F334 lets you manage complex PWM waveforms and handle numerous external events thanks to:

8

#### High-resolution timer with waveform builder and event handler (HRTIM)

- 217 ps high resolution (4.6 GHz equivalent) guaranteed on all channels vs voltage, temperature or manufacturing deviations
  - High resolution on all channels and any timing
  - 10-channel timer made of 6 timings units that can be cross-coupled or work independently
- Advanced PWM waveform generation with minimized software
  - Smart functions, such as a hardware burst mode controller
  - One DMA channel per timer
  - One parameter modification can change multiple events (timer chaining)
- Complex event management
  - 10 external events inputs and 5 fault inputs
- Numerous interconnects

#### High-speed ADCs for precise and accurate control

- 12-bit SAR – 5 MSPS (Million Samples Per Second), single-ended and differential inputs
- Sampling time down to 21 ns
- Multiple triggers for PWM

#### Built-in analog peripherals for signal conditioning and protection

- Ultra-fast comparators (25 ns)
- 12-bit digital-to-analog converter (DAC)

A high-resolution timer cookbook (AN4539), a dedicated Discovery kit (32F3348DISCOVERY) plus and several dedicated D-SMPS evaluation board (ex: STEVAL-ISA147V3 and STEVAL-ISA172V2) help accelerate application development.





# STM32F334 BLOCK DIAGRAM

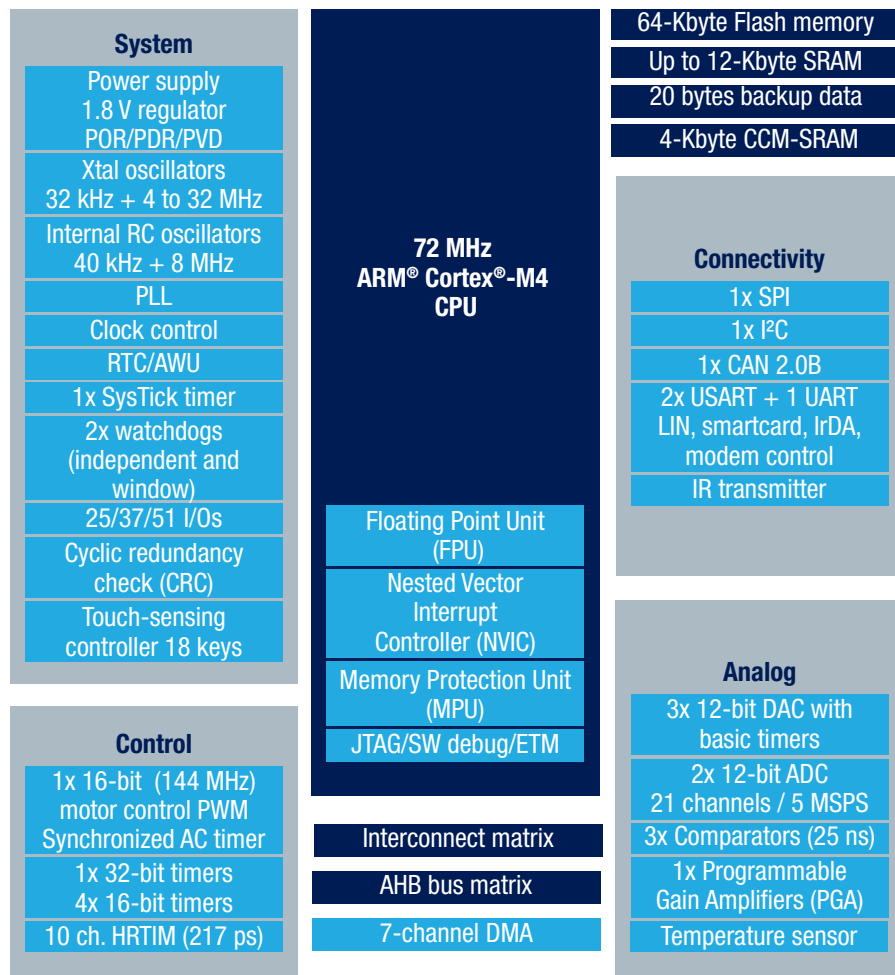

### APPLICATION TARGET

STM32F334 devices greatly simplify digital control of complex power-supply topologies used in:

- Data servers
- Telecom infrastructure
- Wireless charging points
- Lighting
- Welding
- Industrial power supplies
- Digital switch mode power supplies (D-SMPS)

## COMPLEX WAVEFORM BUILDING AND MULTI-EVENT HANDLING (FROM HRTIM) - EXAMPLE

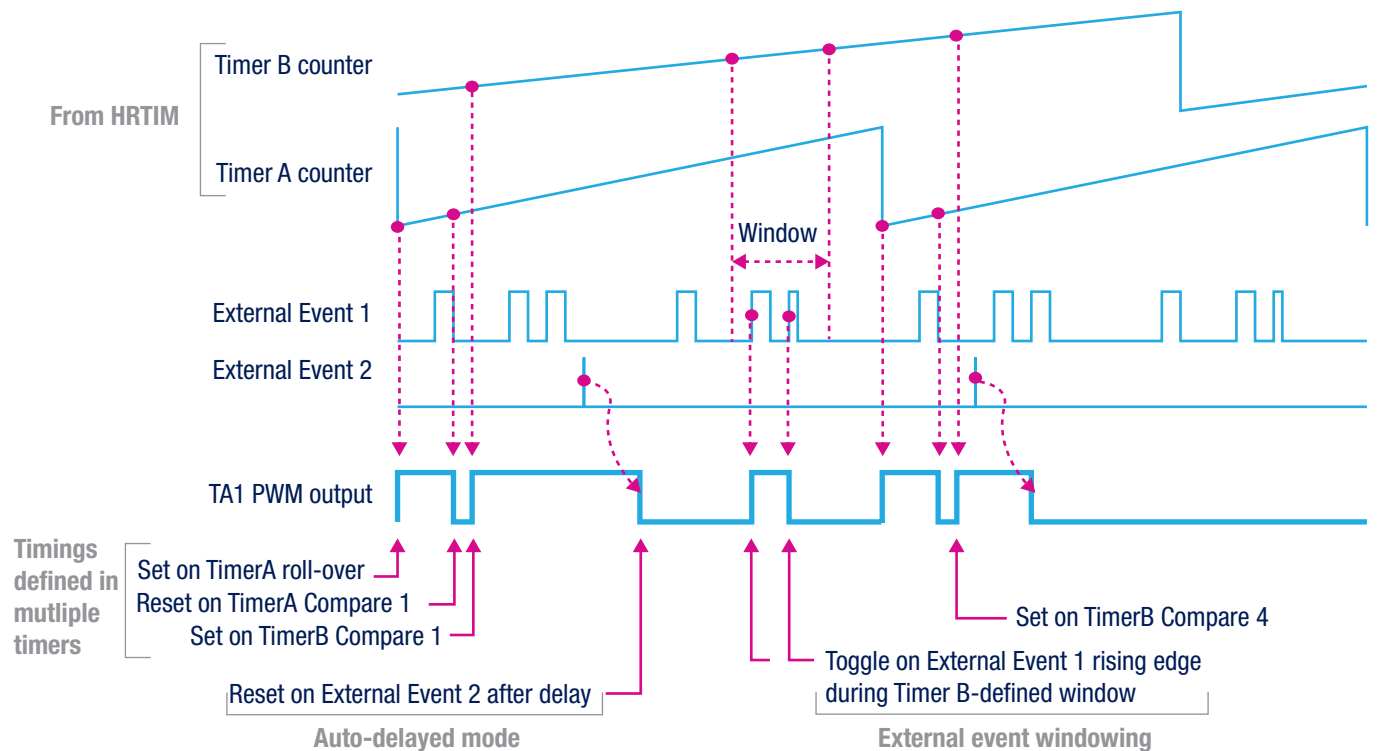



# High precision line

## True 16-bit sigma delta ADC integration

The ARM® Cortex®-M4 based STM32F373 product line integrates 16-bit sigma-delta ADCs, making the devices a perfect fit for all kinds of sensor applications requiring high-precision measurements together with more demanding signal processing.

### STM32F373 PORTFOLIO

Flash memory size / RAM size (bytes)

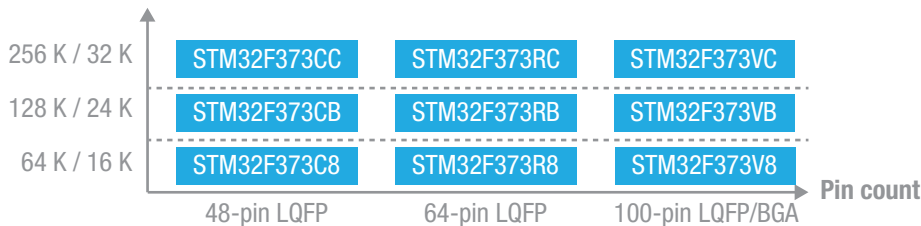

### STM32F373 BLOCK DIAGRAM

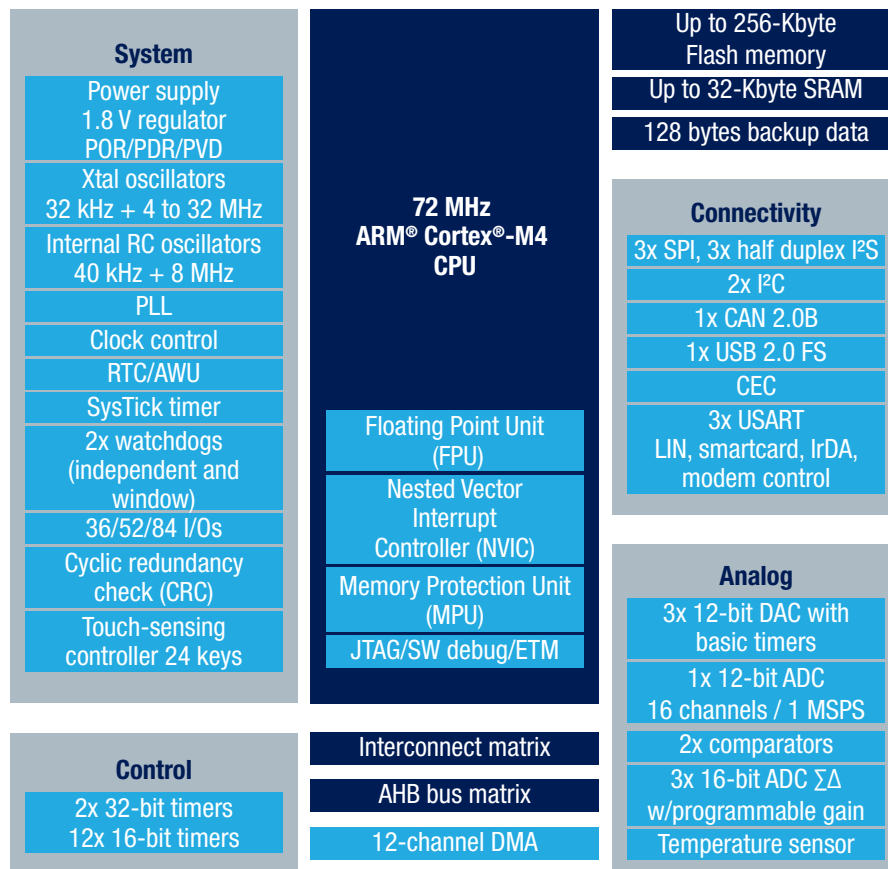

### APPLICATION TARGET

- Portable medical equipment
- Entry-level consumer audio equipment
- Sensor hub for biometric sensors
- Portable fitness
- Gaming
- Metering equipment

### ADVANCED PERIPHERALS

Each STM32F373 device is equipped with three 16-bit sigma-delta ADCs with the following characteristics:

- 16-bit output signed code
- 7 gain levels: ½, 1, 2, 4, 8, 16, and 32
- Differential or single-ended mode:
  - Up to 11 differential input pairs or 21 single-ended combinations over three ΣΔ ADCs
  - Free input configuration as single-ended or differential
- Up to 50 KSPS in Fast mode on one channel (per ΣΔ ADC)
- Independent power supply and V<sub>REF</sub>
- Offset error < 1 LSB after calibration
- 3 different low power modes:
  - Slow: 600 μA (max.), Standby: 200 μA, Power-down: 10 μA (max.)
- 5-volt tolerant I/Os (FT, Ft)



# Low voltage line

## The STM32F3x8 low-voltage 1.8 V line

The STM32F3x8 line operates at  $1.8\text{ V} \pm 8\%$ . It is well suited for use in portable consumer applications such as smartphones, accessories and media devices. Designers can take advantage of the same features as the STM32F3 series with no compromise or degradation in processing performance when operating at a lower voltage. The combination of 1.8 V digital supply voltage and an independent analog domain is an advantage in heterogeneous system architectures, leading to simplified system design and connected cost savings. The STM32F3x8 devices are ideal low-voltage companion microcontrollers, allowing to maintain a wide analog dynamic range.

### STM32F3X8 PORTFOLIO

Flash memory size / RAM size (bytes)

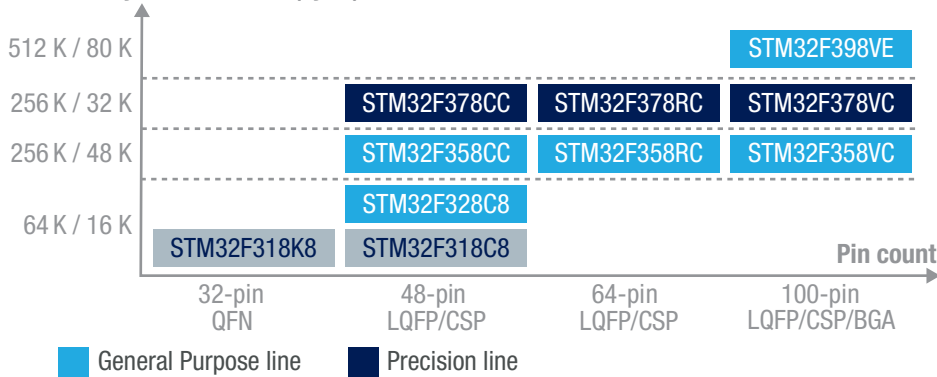

### VOLTAGE RANGE (CORE, I/Os AND VDDA ANALOG)

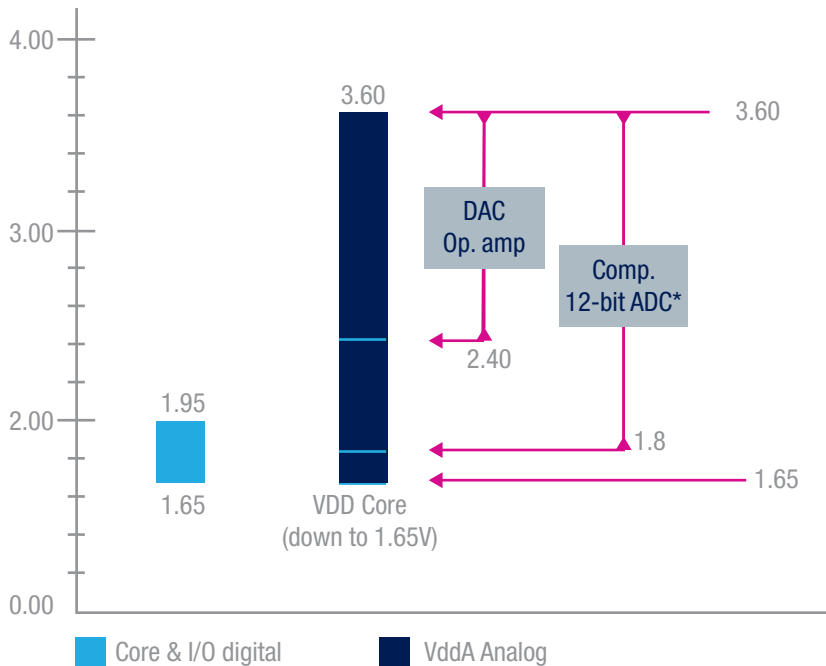

Simple interface with a 1.8 V application processor, ensuring maximum resolution (3.6 V) on ADC, DAC and op amp thanks to dual-voltage domains on the STM32F3.

\* Except STM32F378



# STM32F3 ecosystem

## Hardware tools

Various types of development boards let you get started with STM32F3 products.

The STM32 Nucleo boards provide an affordable and flexible way for users to try out new ideas and build prototypes with a wide choice of specialized expansion boards. The Discovery kits let developers quickly explore key features of STM32F3 products, while the evaluation boards highlight all MCU functions. All these development boards include an integrated debugger/programmer as well as ready-to-use software examples helping developers to promptly get started.

### STM32 Nucleo



#### Flexible prototyping

NUCLEO-F303K8    NUCLEO-F303RE  
NUCLEO-F302R8    NUCLEO-F303ZE  
NUCLEO-F334R8

[www.st.com/stm32nucleo](http://www.st.com/stm32nucleo)

### Discovery kit



#### Key feature prototyping

32F3348DISCOVERY  
STM32F3DISCOVERY

[www.st.com/stm32f3discovery](http://www.st.com/stm32f3discovery)

### Evaluation board



#### Full feature evaluation

STM32303E-EVAL  
STM32373C-EVAL

[www.st.com/stm32evaltools](http://www.st.com/stm32evaltools)

## STM32 NUCLEO

- Open platform with a single STM32 MCU and integrated debugger/programmer.
- At least one board per main series.
- Different types of connectors for unlimited expansion possibilities.
- Support for multiple IDEs and mbed online tools.
- \$10.32 recommended resale price.

[www.st.com/stm32nucleo](http://www.st.com/stm32nucleo)



## STM32 NUCLEO PORTOLIO

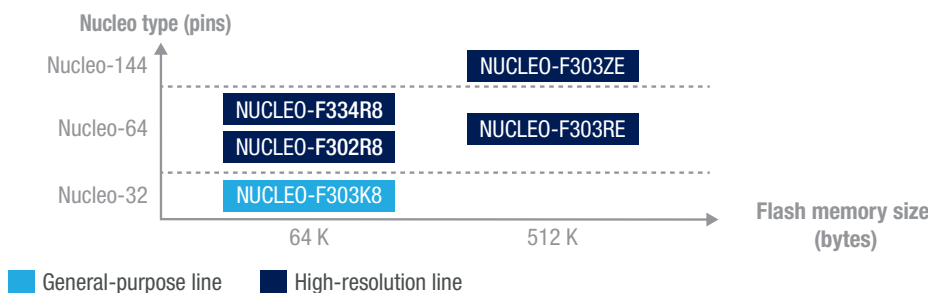

## STM32 NUCLEO EXPANSION BOARDS

- The expansion boards let you add specialized functions (sense, connectivity...) with companion chips through Arduino™ or ST morpho connectors.
- The portability of associated software components enables you to target several STM32 MCUs.

[www.st.com/x-nucleo](http://www.st.com/x-nucleo)

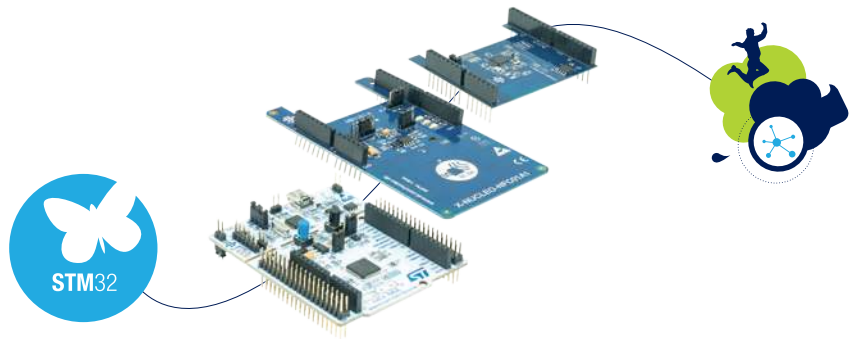

## Software development tools

ST suggests a 3-step approach for standard development in C: configuration and generation, compile and debug, and then monitoring.

1. Configure the microcontroller using STM32CubeMX tool and optionally generate code depending on user choices.
2. Develop the application, compile and debug, using a partner integrated development environment (IDE) such as IAR, Keil, AC6, Atollic, Coccox, Emprog, iSystem, Raisonance, Rowley, Segger, Tasking,...
3. Monitor the application while it is running without being intrusive with STMStudio.

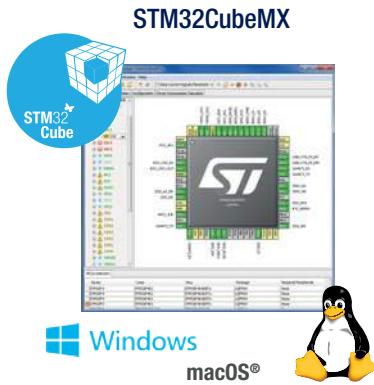

Configure and generate code



Compile and debug

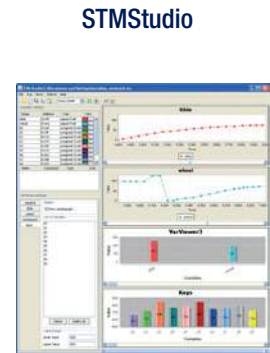

Monitor

## ACHIEVING SIL2/3 WITH STM32F3

Quickly achieve IEC 61508 Safety Integrity Level (SIL) certification with the STM32F3 Functional Safety Package:

- STM32F3 Safety Manual: a user guide including detailed list of safety requirements and examples.
- STM32F3 Self-test library\*: ready to use and certified software to address application independent failures of the MCU.



[www.st.com/stm32safety](http://www.st.com/stm32safety)

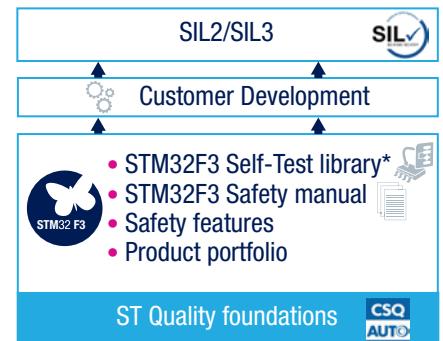

\*Available in 2018

## STM32 MOTOR CONTROL ECOSYSTEM

ST's STM32 MCU family offers the performance of the industry-standard Cortex®-M core with the service of vector control or field-oriented control (FOC) algorithms, widely used in high-performance motor drives.

The STM32 PMSM FOC Software Development Kit (STSW-STM32100) is part of ST's motor control ecosystem which offers a wide range of hardware and software solutions for various power ranges.

The STM32 PMSM FOC SDK lets users evaluate STM32 performance and develop a complete application for single or multiple 3-phase permanent-magnet motor drive systems (sensored or sensorless).

It includes:

- Firmware (FW): Permanent-magnet synchronous motor (PMSM) FOC firmware library
- Graphical User Interface (GUI): ST MC Workbench (to configure the FOC firmware library parameters)

Using this GUI, the user generates all the parameter header files needed to configure the library according to application needs and can in real-time monitor and change certain variables of the algorithm.

### Key features

The STM32 PMSM FOC SDK offers the following features (among others):

- Sensorless motor control algorithm based on the High Frequency Injection (HFI) method for very low or zero speed operation
- "Maximum torque per ampere" (MTPA) control that optimizes the motor torque for each load and increases efficiency
- "Feed-forward" control that improves current control at high speeds
- "Start on the fly" provides smooth drive insertion for applications where the rotor is already rotating (e.g. outdoor fans in air conditioners and smoke extractors)
- Digital PFC: Single-stage boost topology using the same microcontroller driving motor with ST's FOC algorithm

And dedicated features for easy motor Plug'n'Spin operation:

- "Motor Profiler" for automatic detection of motor parameters: Electrical ( $R_s$ ,  $L_s$ , and  $K_e$ ) and mechanical ( $J$  and  $F$ ) to run the motor in less than one minute

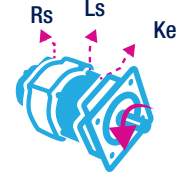

- "One-touch tuning" to control the motor speed using a single knob

### Plug and Spin your Motor in less than 1 minute !

- Automatic detection of key parameters
- Zero equipment required
- Spin motor in less than 1 minute
- Single parameter to tune the speed controller
- Wide speed range
- Adapting to various load/inertia



## STM32 EDUCATION

Our MC education webpages [www.st.com/stm32-education-motor-control](http://www.st.com/stm32-education-motor-control) and [www.st.com/stm32-education-pmsm-motor](http://www.st.com/stm32-education-pmsm-motor) offer a large collection of material related to STM32 and Motor Control.



## STM32 DIGITAL POWER ECOSYSTEM

Digital switch mode power supply (D-SMPS) solutions (HW and FW) based on STM32F334 product line:

- Discovery kit (32F3348DISCOVERY): lighting and buck-boost functions
- Evaluation boards - Digital AC/DC
  - STEVAL-ISA147V3 (500 W): Semi bridgeless PFC + LLC and SR
  - STEVAL-ISA172V2 (2 kW): 2-Phase iPFC + ZVS full-bridge, phase-shifted and SR



STEVAL-ISA147V3



STEVAL-ISA172V2

The P-NUCLEO-IHM001 Nucleo pack is a \$35 motor control kit designed to help engineers and hobbyists experiment with motor control in a very short time. It contains an STM32F3 Nucleo board preloaded with 6-step and FOC algorithms, a motor-driver expansion board based on the STSPIN L6230 motor-driver IC, and a 3-phase low voltage brushless motor using 6-step or FOC algorithms preloaded on the microcontroller. P-NUCLEO-IHM002 embeds P-NUCLEO-IHM001 and a power supply..





# Recommendations for choosing embedded software

When choosing between a strategy for code optimization or portability, here are some recommendations:

- Standard Peripheral Library offers a good tradeoff for users willing to remain within the STM32 F0 series in the future, with a portability level ensured among all STM32F3 MCUs
- STM32CubeF3 embedded software is the correct choice for users who may want to easily port their application to another STM32 MCUs. In addition, this option also benefits from the full features of the STM32CubeMX tool on the PC, enabling access to code generation based on the user configuration and STM32CubeF3 embedded software

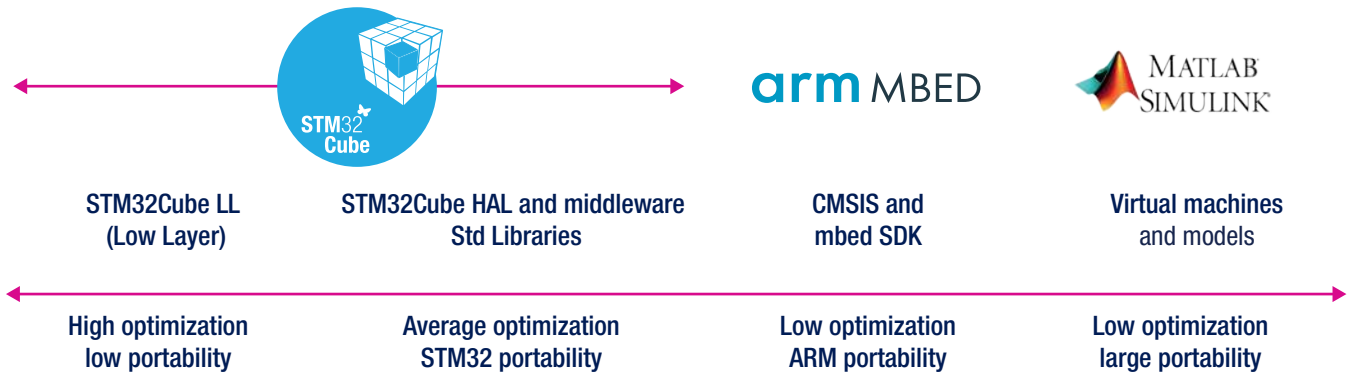

## Focus on model development with MATLAB/Simulink

MATLAB and Simulink users can also benefit from the STM32F3 series with their favorite environment.

A simple 3-step approach is possible using MATLAB and Simulink:

1. Create an algorithm model and simulate it on the host.
2. Generate Processor-in-the-Loop (PIL) code and verify it. This step uses MATLAB/Simulink to generate code optimized for the Cortex®-M4 devices using the DSP instruction set.
3. And finally, let everything run on the STM32F3 MCU using the peripheral blockset provided by ST, enabling the use of real STM32F3 peripherals such as the ADC, DAC, Timers, etc.

(More at [www.st.com/stm32matlab](http://www.st.com/stm32matlab) )

Model development helps reduce development time and specification errors usually found with other methods.





# Collaterals

## FIND INFORMATION AND SUPPORT

- Visit [www.st.com](http://www.st.com) for valuable online information and support on our products to bring your project to life.
- Find the right STM32 MCU and instantly access documentation and the STM32 ecosystem from any desktop or mobile device with the [ST MCU Finder](#).
- Ask, learn, share, discuss, and engage with STM32 enthusiasts and developers on [ST Ccommunity](#).
- Join us on Facebook, Twitter and Youtube and stay connected with the world of STM32.



[st.com](http://st.com)

ST MCU finder

Communities and social media

## STM32F3 shortcuts

[www.st.com/stm32f3](http://www.st.com/stm32f3)  
[www.st.com/stm32f3discovery](http://www.st.com/stm32f3discovery)  
[www.st.com/stm32evaltools](http://www.st.com/stm32evaltools)  
[www.st.com/stm32discovery](http://www.st.com/stm32discovery)  
[www.st.com/stm32nucleo](http://www.st.com/stm32nucleo)

[www.st.com/stm32embeddedsoftware](http://www.st.com/stm32embeddedsoftware)  
[www.st.com/stm32cube](http://www.st.com/stm32cube)  
[mbed.org](http://mbed.org)  
[www.st.com/stm32matlab](http://www.st.com/stm32matlab)  
[www.st.com/stm32cufinder](http://www.st.com/stm32cufinder)

[www.st.com/stmstudio](http://www.st.com/stmstudio)  
[www.st.com/x-nucleo](http://www.st.com/x-nucleo)  
[www.st.com/stm32safety](http://www.st.com/stm32safety)  
[www.st.com/stm32-education-motor-control](http://www.st.com/stm32-education-motor-control)

### ST COMMUNITY

Ask, learn, share, discuss, become famous and engage with the community of STM32 enthusiasts on [community.st.com/stm32](http://community.st.com/stm32)