

- NOTES:
- MATERIAL:
 - HOUSINGS: LCP UL94, V-0, COLOR: BLACK
 - TERMINALS: HIGH CONDUCTIVITY COPPER ALLOY
 - PLATING: 1.27 MICROMETER (50 MICROINCH) NICKEL OVERALL WITH 2.54 MICROMETER (100 MICROINCH) SELECTIVE TIN ON TAILS AND 0.762 MICROMETER (30 MICROINCH) SELECTIVE GOLD ON CONTACT AREA
 - PACKAGING: ASSEMBLIES TO BE TRAY PACKED PER PACKAGING SPEC: 1710881001-PK
 - PLATED THRU HOLE SIZE, REFER TO PS-171088-0000 FOR DETAILS
 - PRODUCT SPEC: PS-171088-0000
 - PRODUCT TO MEET RoHS REQUIREMENTS
 - ASSEMBLY MATES TO MOLEX RECEPTACLE ASSEMBLY P/N 171089-**** AND 171090-**** (SEE TABLE IN SHEET 2)
 - TAIL DESIGN: COMPLIANT TAIL
 - POWER AND SIGNAL CONTACTS ARE LUBRICATED.
 - APPLICATION SPEC: AS-46436-100..
 - MOLEX LOGO TO BE LOCATED APPROXIMATELY AS SHOWN.

THIS DRAWING CONTAINS INFORMATION THAT IS PROPRIETARY TO MOLEX ELECTRONIC TECHNOLOGIES, LLC AND SHOULD NOT BE USED WITHOUT WRITTEN PERMISSION									
DIMENSION UNITS	SCALE	CURRENT REV DESC: ADDED ISO VIEWS							
mm	3:1								
GENERAL TOLERANCES (UNLESS SPECIFIED)									
ANGULAR TOL	± 0.5°								
4 PLACES	±	EC NO: 689821							
3 PLACES	±	DRWN: KSUTAR		2021/12/15					
2 PLACES	± 0.13	CHK'D: GJEEVANSURES		2021/12/22					
1 PLACE	± 0.25	APPR: HTHYAGARAJ		2022/02/14					
0 PLACES	±	INITIAL REVISION:							
DRAFT WHERE APPLICABLE MUST REMAIN WITHIN DIMENSIONS		DRWN: KSUTAR		2021/09/23					
		APPR: HTHYAGARAJ		2021/11/08					
THIRD ANGLE PROJECTION		DRAWING		SERIES					
D-DRAWING		171088							
MATERIAL NUMBER		CUSTOMER						SHEET NUMBER	
SEE TABLE		GENERAL MARKET						1 OF 4	

RECOMMENDED PCB LAYOUT AND KEEP-OUT ZONE FOR G-(1SP TO 5SP)-30S-(1SP TO 5SP)-G

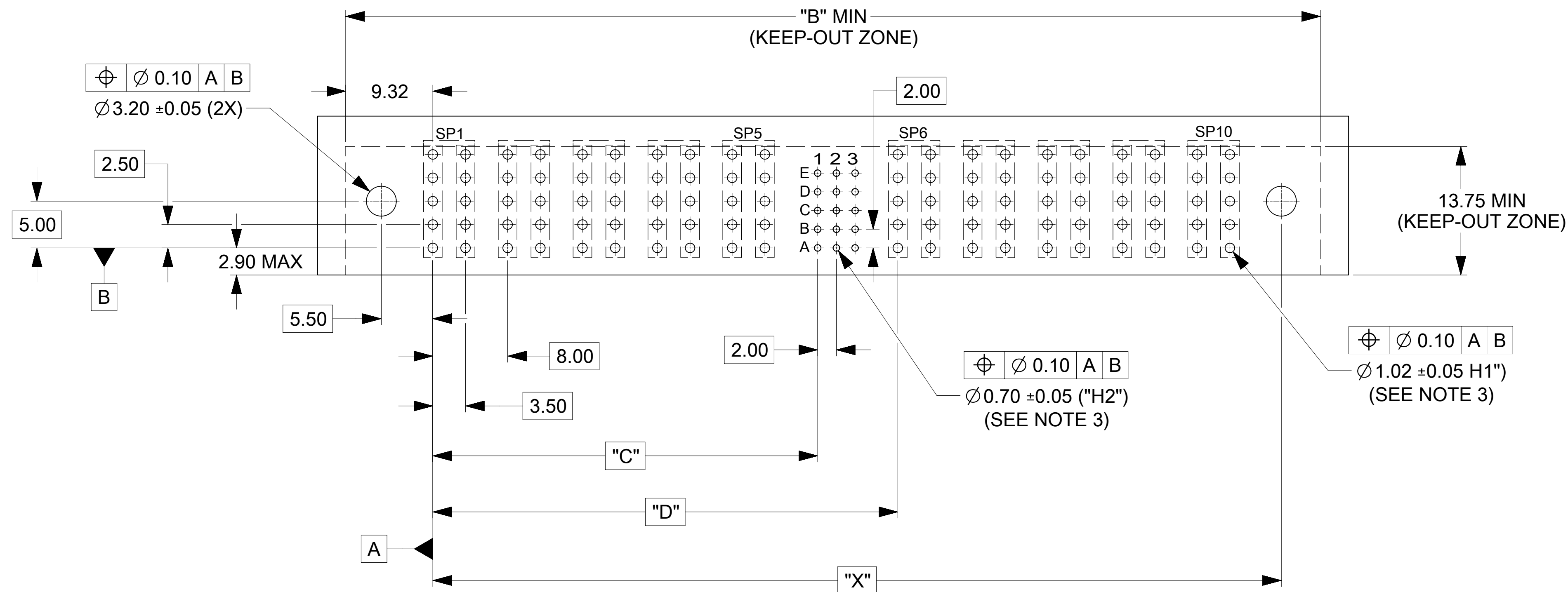

RECOMMENDED PCB LAYOUT AND KEEP-OUT ZONE FOR G-(1SP TO 5SP)-15S-(1SP TO 5SP)-G

REFER TO BELOW TABLE FOR DIMENSIONS.

FG P/N	CONFIGURATION	POWER CKT SIZE	SIGNAL CKT SIZE	DIM "A" (IN MM)	DIM "B" (IN MM)	DIM "C" (IN MM)	DIM "D" (IN MM)	DIM "X" (IN MM)	HOLES COUNT "H1"	HOLES COUNT "H2"	MATES WITH R/A ASSY P/N	MATES WITH VERT ASSY P/N
1710888421	G-1SP-15S-1SP-G	1	15	39.21	40.21	9.14	17.71	26.71	20	15	1710908421	1710898421
1710888422	G-2SP-15S-2SP-G	2	15	55.21	56.21	17.14	25.71	42.71	40	15	1710908422	1710898422
1710888423	G-3SP-15S-3SP-G	3	15	71.21	72.21	25.14	33.71	58.71	60	15	1710908423	1710898423
1710888424	G-4SP-15S-4SP-G	4	15	87.21	88.21	33.14	41.71	74.71	80	15	1710908424	1710898424
1710888425	G-5SP-15S-5SP-G	5	15	103.21	104.21	41.14	49.71	90.71	100	15	1710908425	1710898425
1710888426	G-1SP-30S-1SP-G	1	30	45.21	46.21	9.14	23.71	32.71	20	30	1710908426	1710898426
1710888427	G-2SP-30S-2SP-G	2	30	61.21	62.21	17.14	31.71	48.71	40	30	1710908427	1710898427
1710888428	G-3SP-30S-3SP-G	3	30	77.21	78.21	25.14	39.71	64.71	60	30	1710908428	1710898428
1710888429	G-4SP-30S-4SP-G	4	30	93.21	94.21	33.14	47.71	80.71	80	30	1710908429	1710898429
1710888430	G-5SP-30S-5SP-G	5	30	109.21	110.21	41.14	55.71	96.71	100	30	1710908430	1710898430

THIS DRAWING CONTAINS INFORMATION THAT IS PROPRIETARY TO MOLEX ELECTRONIC TECHNOLOGIES, LLC AND SHOULD NOT BE USED WITHOUT WRITTEN PERMISSION

DIMENSION UNITS	SCALE	CURRENT REV DESC: ADDED ISO VIEWS	
mm	3:1		
GENERAL TOLERANCES (UNLESS SPECIFIED)			
ANGULAR TOL	± 0.5°		
4 PLACES	±	EC NO: 689821	
3 PLACES	±	DRWN: KSUTAR	2021/12/15
2 PLACES	± 0.13	CHK'D: GJEEVANSURES	2021/12/22
1 PLACE	± 0.25	APPR: HTHYAGARAJ	2022/02/14
0 PLACES	±	INITIAL REVISION:	
DRAFT WHERE APPLICABLE MUST REMAIN WITHIN DIMENSIONS		DRWN: KSUTAR	2021/09/23
		APPR: HTHYAGARAJ	2021/11/08
THIRD ANGLE PROJECTION	DRAWING	SERIES	DOCUMENT NUMBER
		D-SIZE 171088	171088430
MATERIAL NUMBER		CUSTOMER	REVISION
SEE TABLE		GENERAL MARKET	PSD 000 A1
SHEET NUMBER		2 OF 4	

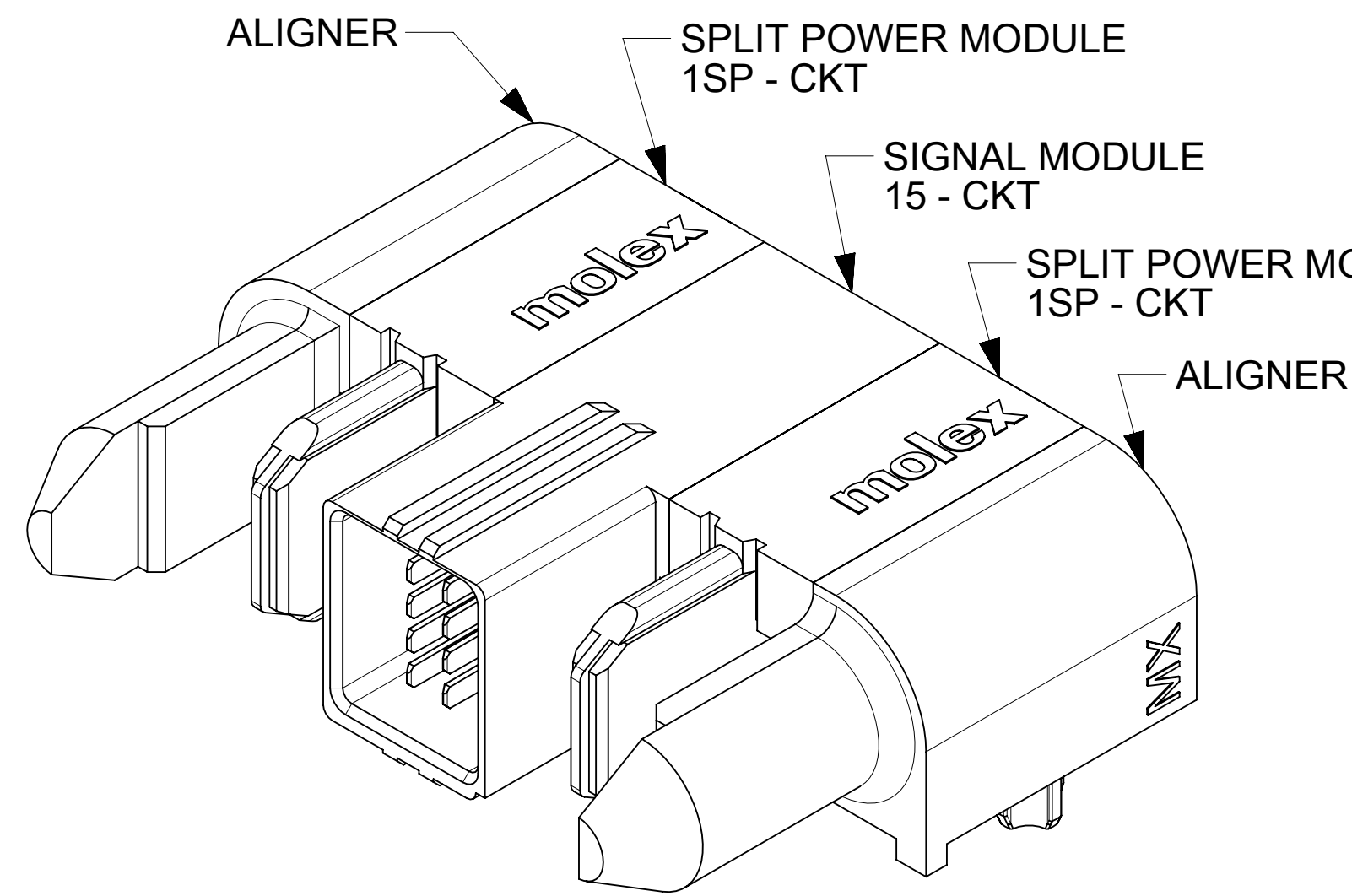

P/N: 171088-8421 (G-1SP-15S-1SP-G)

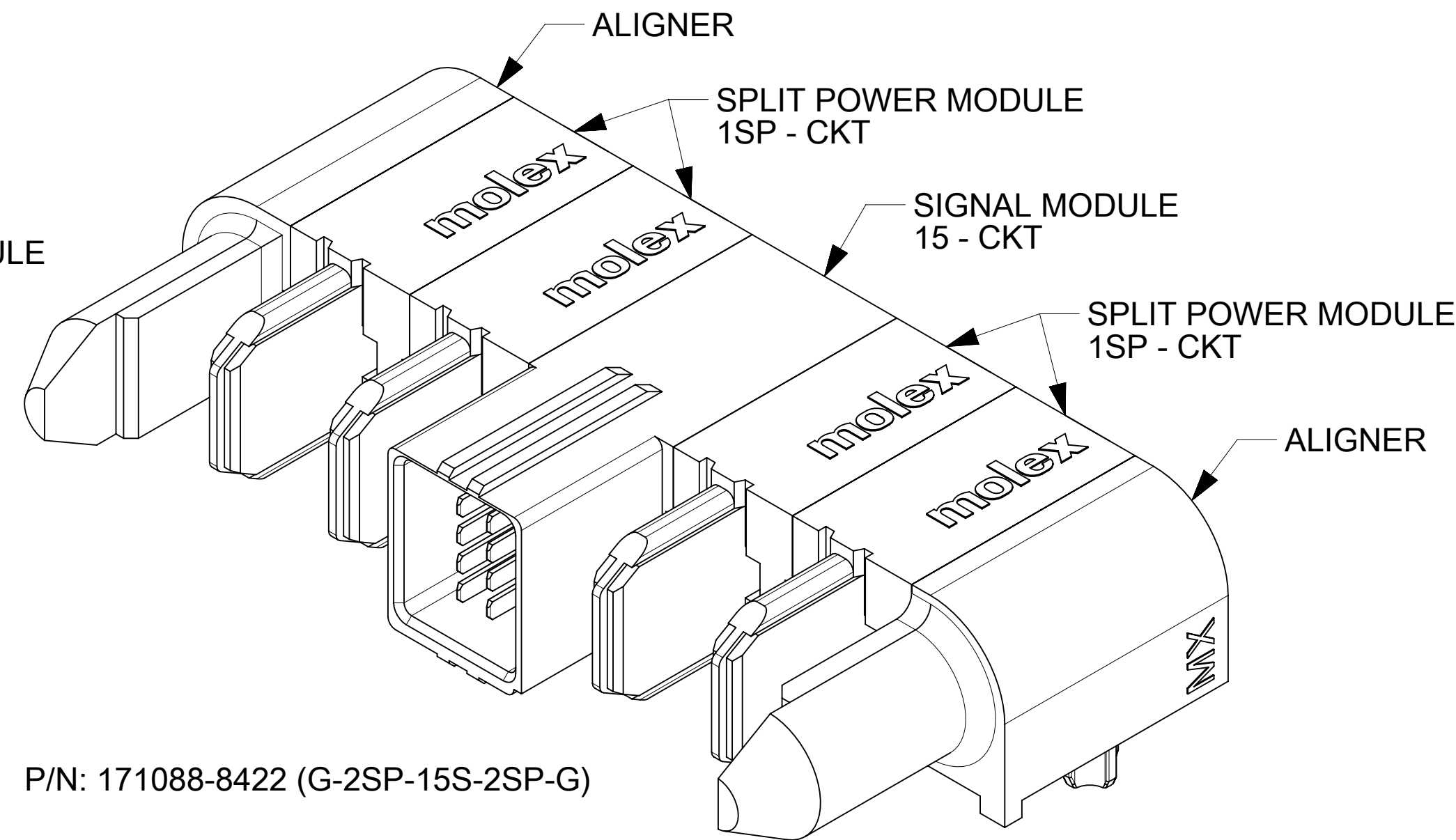

P/N: 171088-8422 (G-2SP-15S-2SP-G)

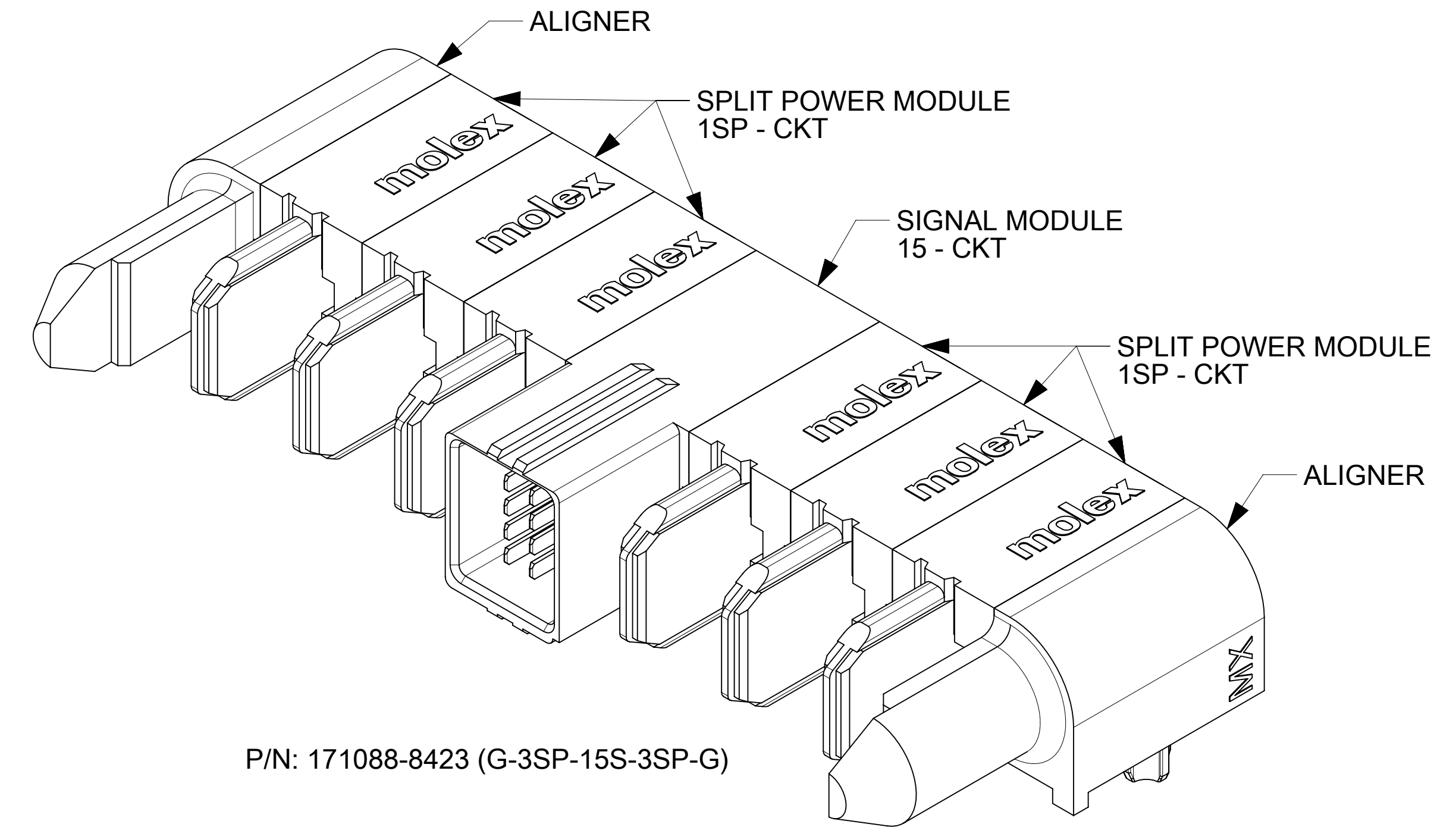

P/N: 171088-8423 (G-3SP-15S-3SP-G)

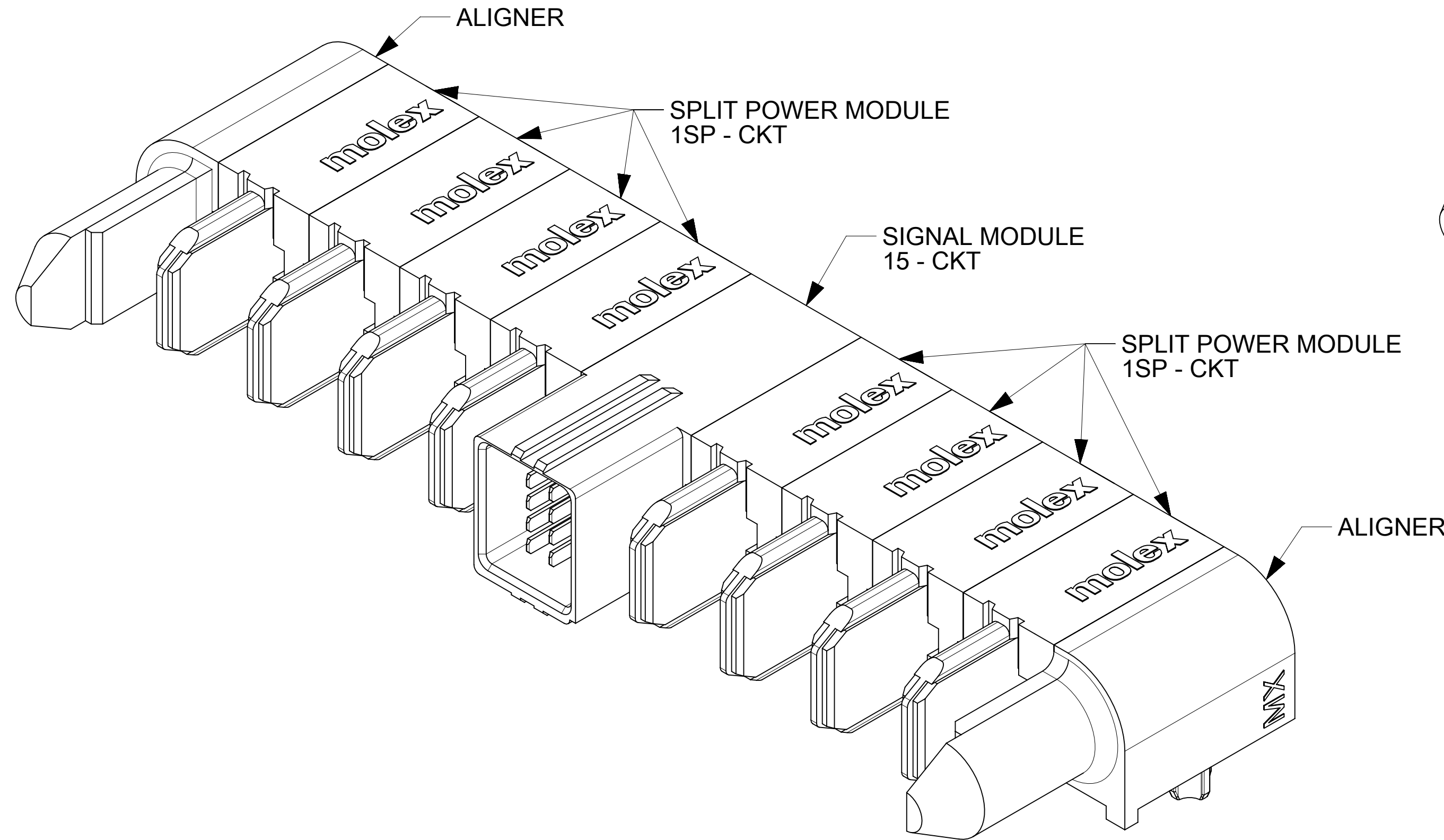

P/N: 171088-8424 (G-4SP-15S-4SP-G)

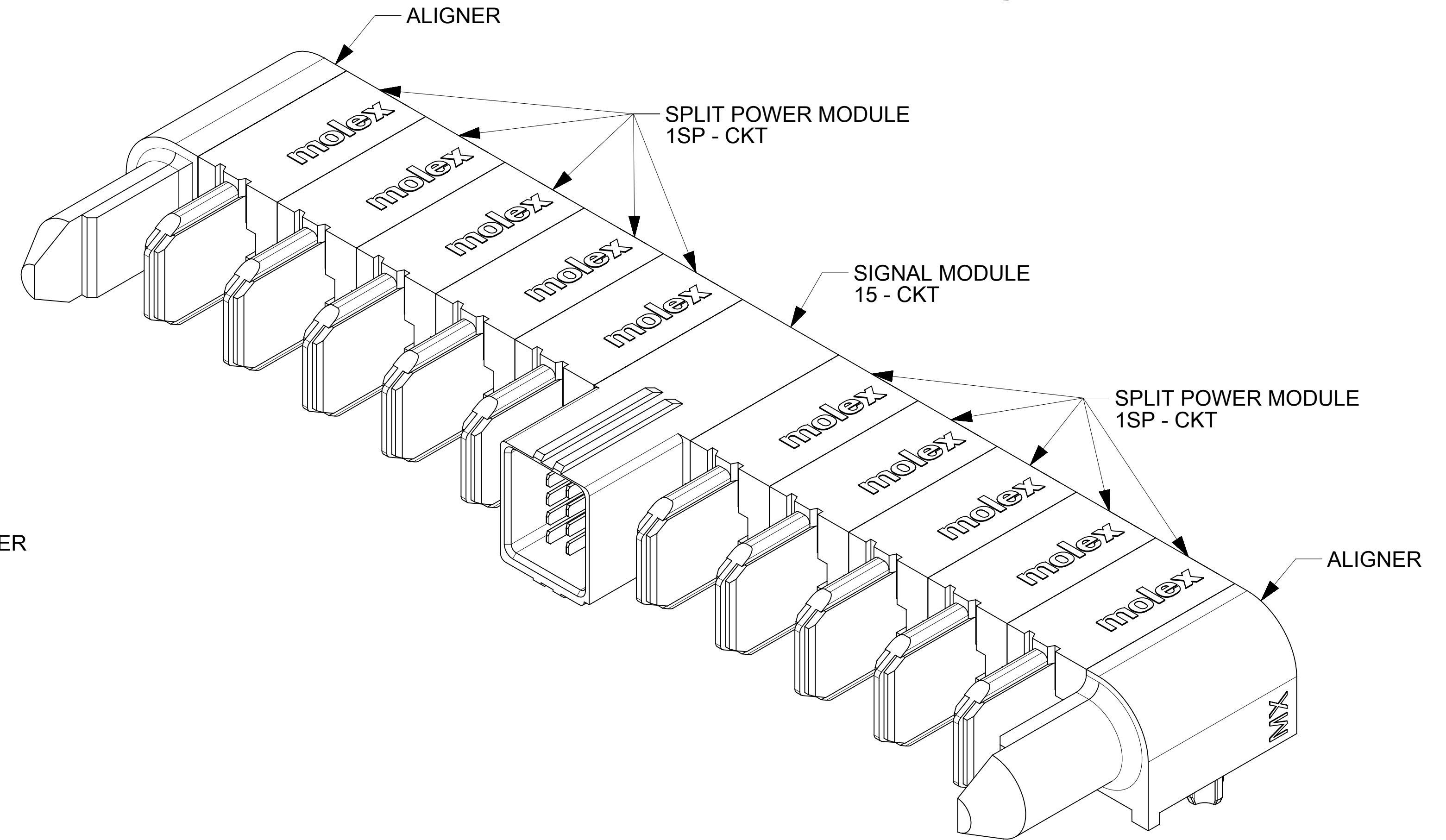

P/N: 171088-8425 (G-5SP-15S-5SP-G)

THIS DRAWING CONTAINS INFORMATION THAT IS PROPRIETARY TO MOLEX ELECTRONIC TECHNOLOGIES, LLC AND SHOULD NOT BE USED WITHOUT WRITTEN PERMISSION									
DIMENSION UNITS	SCALE	CURRENT REV DESC: ADDED ISO VIEWS							
mm	4:1								
GENERAL TOLERANCES (UNLESS SPECIFIED)									
ANGULAR TOL	± 0.5°								
4 PLACES	±								
3 PLACES	±								
2 PLACES	± 0.13								
1 PLACE	± 0.25								
0 PLACES	±								
DRAFT WHERE APPLICABLE MUST REMAIN WITHIN DIMENSIONS		THIRD ANGLE PROJECTION	DRAWING	SERIES					
				171088					
		D-SIZE	171088						
		MATERIAL NUMBER	CUSTOMER						
		SEE TABLE	GENERAL MARKET						
		SHEET NUMBER							
		3 OF 4							

molex

G-*SP-*S-*SP-G
R/A PLUG ASSY - TEN60 SPLIT POWER

PRODUCT CUSTOMER DRAWING

DOCUMENT NUMBER	DOC TYPE	DOC PART	REVISION
1710888430	PSD	000	A1

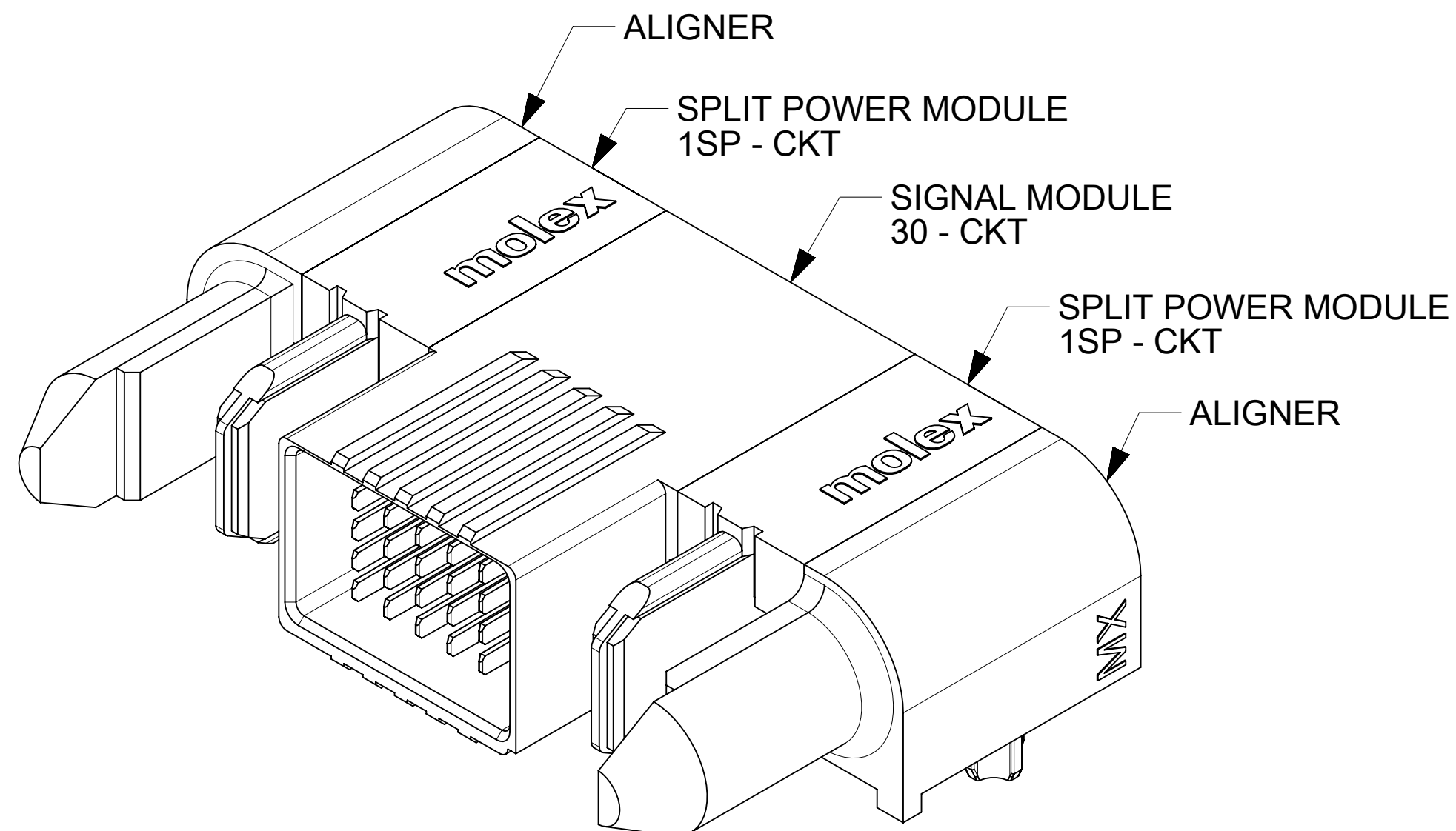

P/N: 171088-8426 (G-1SP-30S-1SP-G)

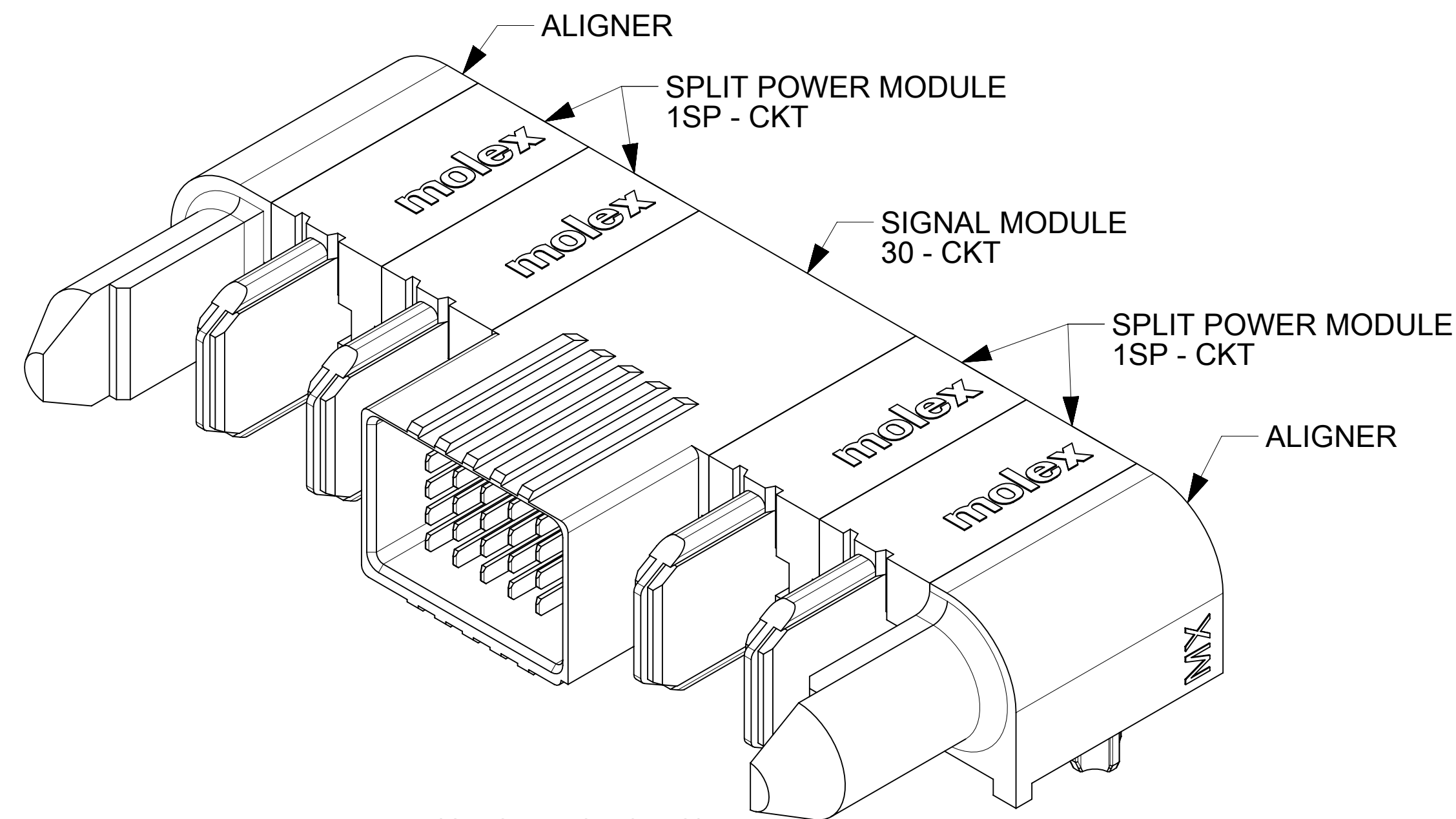

P/N: 171088-8427 (G-2SP-30S-2SP-G)

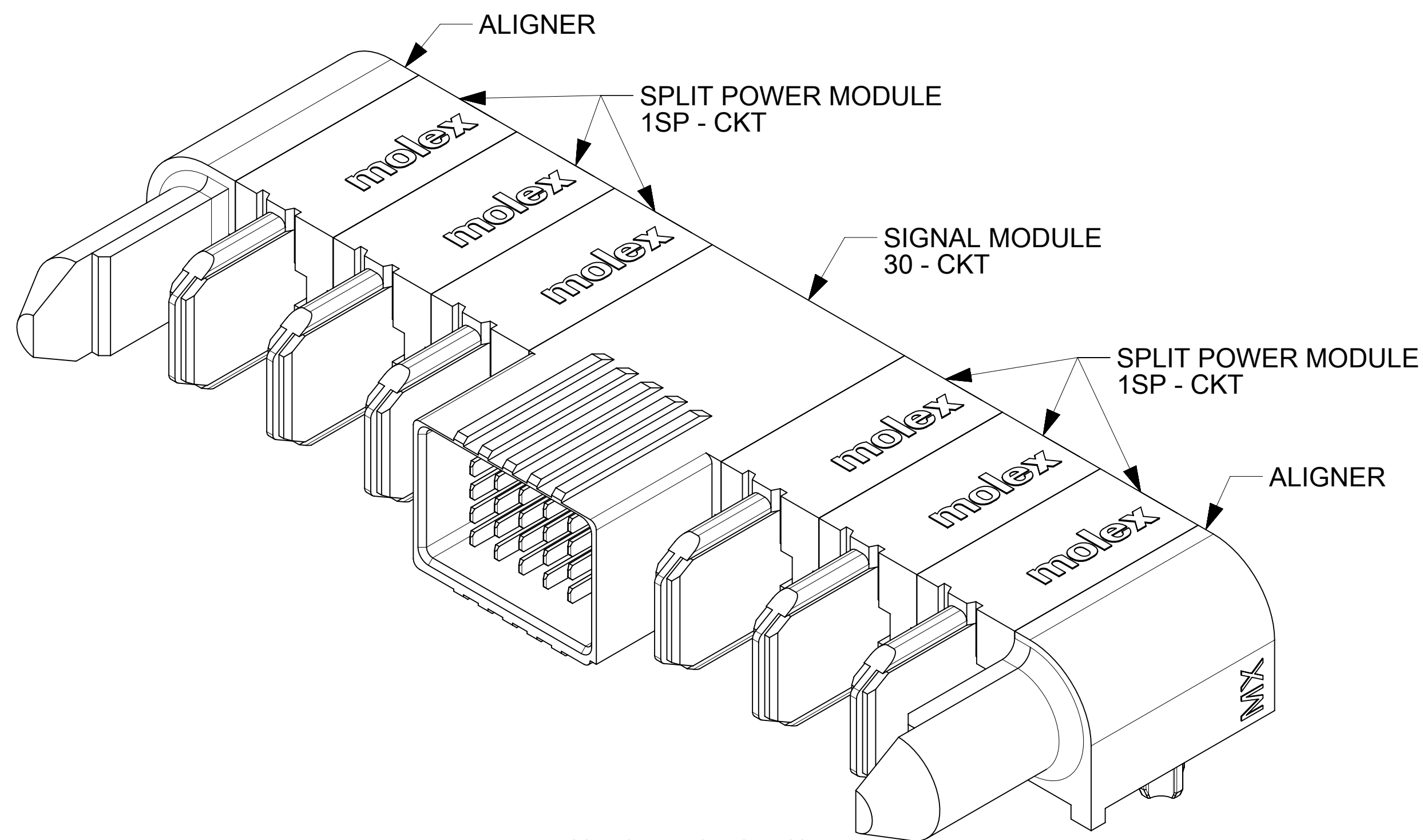

P/N: 171088-8428 (G-3SP-30S-3SP-G)

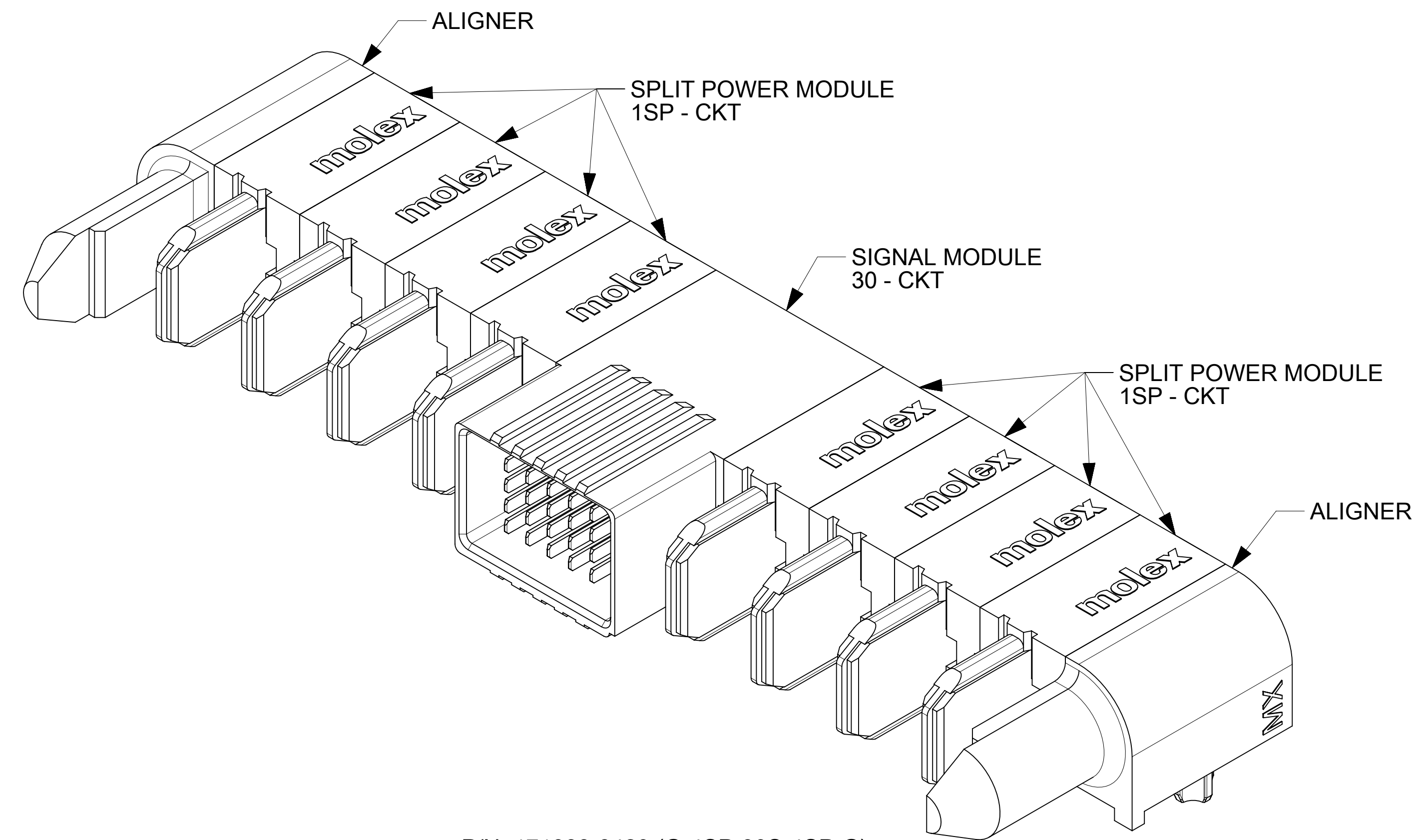

P/N: 171088-8429 (G-4SP-30S-4SP-G)

THIS DRAWING CONTAINS INFORMATION THAT IS PROPRIETARY TO MOLEX ELECTRONIC TECHNOLOGIES, LLC AND SHOULD NOT BE USED WITHOUT WRITTEN PERMISSION											
DIMENSION UNITS		SCALE		CURRENT REV DESC: ADDED ISO VIEWS							
mm		4:1									
GENERAL TOLERANCES (UNLESS SPECIFIED)											
ANGULAR TOL		± 0.5°									
4 PLACES		±		EC NO: 689821							
3 PLACES		±		DRWN: KSUTAR		2021/12/15					
2 PLACES		± 0.13		CHK'D: GJEEVANSURES		2021/12/22					
1 PLACE		± 0.25		APPR: HTHYAGARAJ		2022/02/14					
0 PLACES		±		INITIAL REVISION:							
				DRWN: KSUTAR		2021/09/23					
				APPR: HTHYAGARAJ		2021/11/08					
DRAFT WHERE APPLICABLE MUST REMAIN WITHIN DIMENSIONS				THIRD ANGLE PROJECTION		DRAWING		SERIES		MATERIAL NUMBER	
						D-SIZE		171088		SEE TABLE	
										CUSTOMER	
										GENERAL MARKET	
										SHEET NUMBER	
										4 OF 4	

molex

G-*SP-*S-*SP-G
R/A PLUG ASSY - TEN60 SPLIT POWER

PRODUCT CUSTOMER DRAWING

DOCUMENT NUMBER	DOC TYPE	DOC PART	REVISION
1710888430	PSD	000	A1