

# M17-3EP1N8A8003S/1,5 - Cable connector



1069488

<https://www.phoenixcontact.com/us/products/1069488>

Please be informed that the data shown in this PDF document is generated from our online catalog. Please find the complete data in the user documentation. Our general terms of use for downloads are valid.



M17, Cable connector, series: M17 PRO, straight, shielded: yes, ONECLICK fast locking system, No. of pos.: 3+PE, contact connection type: Pin, contact diameter 1.5 mm, Crimp connection, cable diameter range: 5.5 mm ... 9.5 mm, coding: N, Item is lead-free in accordance with RoHS II without Exemption 6c (Pb <0.1%)

## Your advantages

- Solutions with cross-manufacturer compatibility for standard and fast locking systems
- ONECLICK fast locking system with an optically, haptically, and acoustically clear locking position
- Reliable under the harshest conditions: cable connectors with vibration brake
- Modern, consistent design for highly convenient operation
- Easy, cost-effective cable assembly: uniform shielding of M17 to M40

## Commercial data

Item number	1069488
Packing unit	1 pc
Minimum order quantity	1 pc
Sales key	AB36
Product key	ABRBAB
GTIN	4055626746456
Weight per piece (including packing)	22.22 g
Weight per piece (excluding packing)	22.22 g
Customs tariff number	85366990
Country of origin	DE

## Technical data

### Notes

General	Order 4 x Ø 1.5 mm crimp contacts separately
Safety note	
Safety note	<p>WARNING: The connectors may not be plugged in or disconnected under load. Ignoring the warning or improper use may damage persons and/or property.</p> <ul style="list-style-type: none"> <li>• WARNING: Commission properly functioning products only. The products must be regularly inspected for damage. Decommission defective products immediately. Replace damaged products. Repairs are not possible.</li> <li>• WARNING: Only electrically qualified personnel may install and operate the product. They must observe the following safety notes. The qualified personnel must be familiar with the basics of electrical engineering. They must be able to recognize and prevent danger. The relevant symbol on the packaging indicates that only personnel familiar with electrical engineering are allowed to install and operate the product.</li> <li>• The products are suitable for applications in plant, controller, and electrical device engineering.</li> <li>• When operating the connectors in outdoor applications, they must be separately protected against environmental influences.</li> <li>• Assembled products may not be manipulated or improperly opened.</li> <li>• Only use mating connectors that are specified in the technical data of the standards listed (e.g. the ones listed in the product accessories online at <a href="https://www.phoenixcontact.com/products">phoenixcontact.com/products</a>).</li> <li>• When using the product in direct connection with third-party manufacturers, the user is responsible.</li> <li>• For operating voltages &gt; 50 V AC, conductive connector housings must be grounded</li> <li>• Ensure that the protective or functional ground has been properly connected.</li> <li>• VDE 0100/1.97 § 411.1.3.2 and DIN EN 60 204/11.98 § 14.1.3 are applicable when combining several circuits in a cable and/or connector</li> <li>• Only use tools recommended by Phoenix Contact</li> <li>• The installation notes/Design In documents online on the download page at <a href="https://www.phoenixcontact.com/products">phoenixcontact.com/products</a> must be observed for this product.</li> <li>• Operate the connector only when it is fully plugged in and interlocked.</li> <li>• Ensure that when laying the cable, the tensile load on the connectors does not exceed the upper limit specified in the standards.</li> <li>• Observe the minimum bending radius of the cable. Lay the cable without twisting it.</li> <li>• The connector warms up in normal operation. Depending on the ambient conditions, the surface of the connector can continue to warm up. In this case, the user is responsible for posting</li> </ul>

# M17-3EP1N8A8003S/1,5 - Cable connector



1069488

<https://www.phoenixcontact.com/us/products/1069488>

warnings (e.g. DIN EN ISO 13732-1:2008-12).

## Product properties

Product type	Circular connector (cable-side)
--------------	---------------------------------

## Connector

### Insulating body

Coding	N
Insulation body material	PA 6.6
Insertion/withdrawal cycles	100
Connection method	Crimp connection
Contact switching type	Pin, contact diameter 1.5 mm
Application	Power
Number of positions	4
Connection profile	3+PE
Contact diameter <b>Power contacts</b>	1.5 mm
Litz wire cross-section <b>Power contacts</b> min.	0.25 mm <sup>2</sup>
Litz wire cross-section <b>Power contacts</b> max.	2.5 mm <sup>2</sup>
Rated current <b>Power contacts</b>	20 A
Note	for max. connection cross section
Rated voltage	630 V
Rated surge voltage	6 kV
Overvoltage category	III
Degree of pollution	3
Contact diameter <b>Signal contacts</b>	1.5 mm
Litz wire cross-section <b>Signal contacts</b> min.	0.25 mm <sup>2</sup>
Litz wire cross-section <b>Signal contacts</b> max.	2.5 mm <sup>2</sup>
Installation height	3000 m

### Housing

Housing material	GD-Zn
Type of locking	ONECLICK fast locking system
Pg screw connection	none
Degree of protection (plugged in)	IP67 IP68, 24 h / 2 m
Thread type	M17

### Seal

External cable diameter	5.5 mm ... 9.5 mm
-------------------------	-------------------

## Environmental and real-life conditions

### Ambient conditions

# M17-3EP1N8A8003S/1,5 - Cable connector



1069488

<https://www.phoenixcontact.com/us/products/1069488>

Ambient temperature (operation)

-40 °C ... 105 °C (see derating curve)

# M17-3EP1N8A8003S/1,5 - Cable connector

1069488

<https://www.phoenixcontact.com/us/products/1069488>

## Drawings

Dimensional drawing

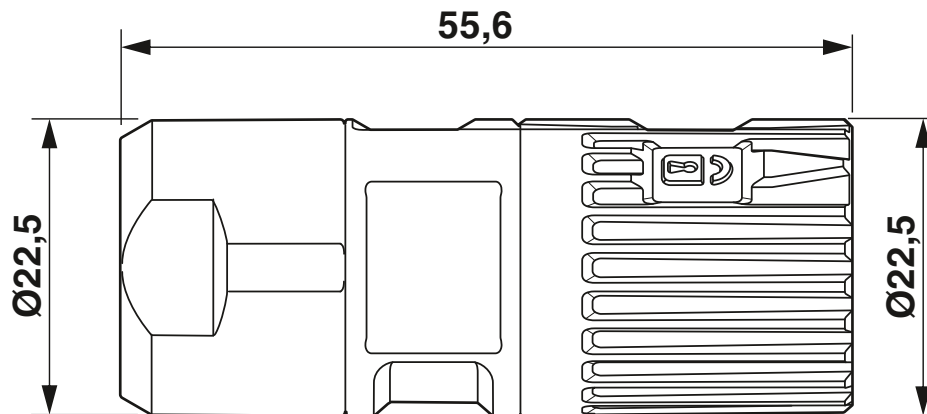

Dimensional drawing

Diagram

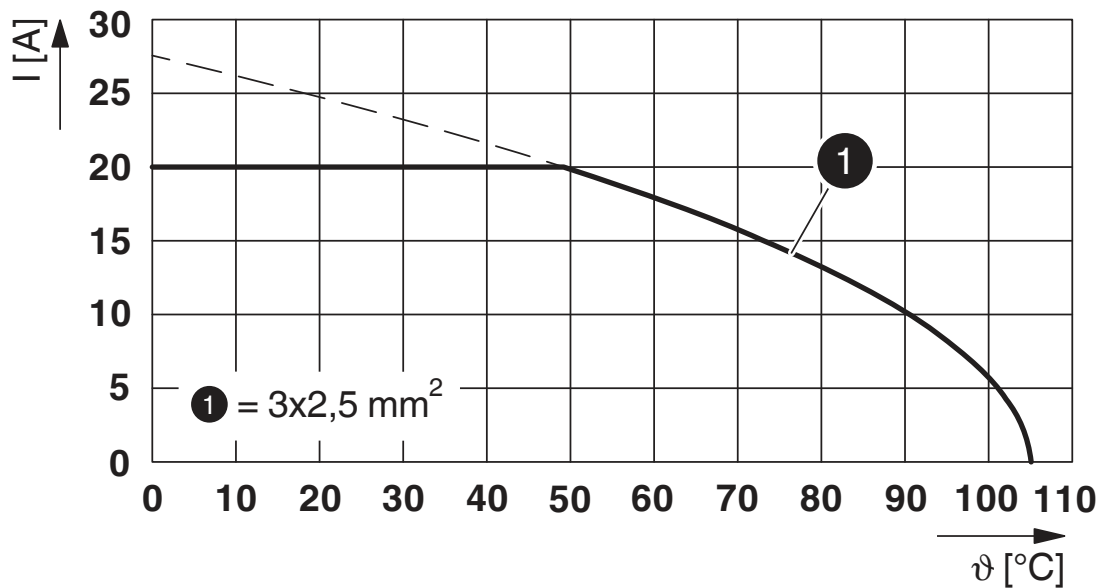

$I$  = current strength,  $\vartheta$  = ambient temperature, 3x 20 A

# M17-3EP1N8A8003S/1,5 - Cable connector

1069488

<https://www.phoenixcontact.com/us/products/1069488>

Schematic diagram

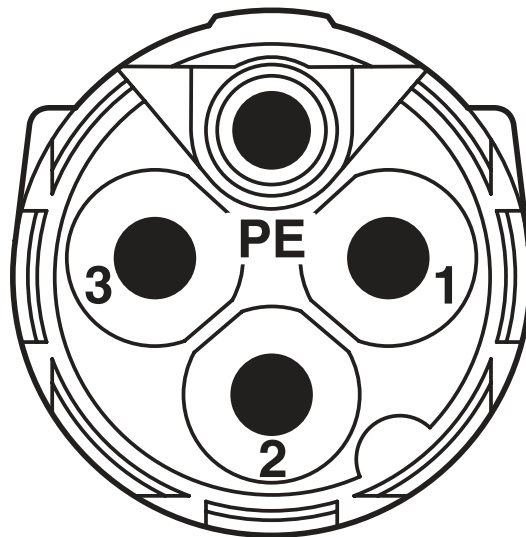

Connector pin assignment

# M17-3EP1N8A8003S/1,5 - Cable connector



1069488

<https://www.phoenixcontact.com/us/products/1069488>

## Classifications

### ECLASS

ECLASS-11.0	27440102
ECLASS-12.0	27440116
ECLASS-13.0	27440116

### ETIM

ETIM 8.0	EC002635
----------	----------

### UNSPSC

UNSPSC 21.0	39121400
-------------	----------

# M17-3EP1N8A8003S/1,5 - Cable connector



1069488

<https://www.phoenixcontact.com/us/products/1069488>

## Environmental product compliance

China RoHS	Environmentally friendly use period: unlimited = EFUP-e
	No hazardous substances above threshold values



# M17-3EP1N8A8003S/1,5 - Cable connector



1069488

<https://www.phoenixcontact.com/us/products/1069488>

## Accessories

### ST-15KP0,25-2,50 - Crimp contact

1213852

<https://www.phoenixcontact.com/us/products/1213852>



Crimp contact, Pin, turned, contact diameter: 1.5 mm, crimp range: 0.25 mm<sup>2</sup> ... 2.5 mm<sup>2</sup>, Item is lead-free in accordance with RoHS II without Exemption 6c (Pb <0.1%)

---

### M17-Z0011 - Tool

1089155

<https://www.phoenixcontact.com/us/products/1089155>



Nut for assembling M17-PRO series cable connectors and for 4 mm hexagonal drive

# M17-3EP1N8A8003S/1,5 - Cable connector



1069488

<https://www.phoenixcontact.com/us/products/1069488>

## TSD-M 1,2NM - Torque screwdriver

1212224

<https://www.phoenixcontact.com/us/products/1212224>



Torque screw driver, accuracy as per EN ISO 6789 standard, adjustable from 0.3 - 1.2 Nm

---

## TSD-M SAC-BIT ADAPTER - Adapter insert

1212600

<https://www.phoenixcontact.com/us/products/1212600>



Adapter bit for TSD-M...torque tools, E6.3-1/4" drive with 4 mm hexagon to accommodate SAC bits

# M17-3EP1N8A8003S/1,5 - Cable connector



1069488

<https://www.phoenixcontact.com/us/products/1069488>

## PROT-M17PRO-IT-IP20 - Plastic protective cap

1055709

<https://www.phoenixcontact.com/us/products/1055709>

Plastic protective cap, M17, degree of protection: IP20, series: M17 PRO



---

## PROT-M17PRO-IT-IP67 - Plastic protective cap

1055707

<https://www.phoenixcontact.com/us/products/1055707>

Plastic protective cap, M17, degree of protection: IP67, series: M17 PRO



---

Phoenix Contact 2023 © - all rights reserved  
<https://www.phoenixcontact.com>

Phoenix Contact USA  
586 Fulling Mill Road  
Middletown, PA 17057, United States  
(+717) 944-1300  
[info@phoenixcon.com](mailto:info@phoenixcon.com)