

**Molex Terminator
Use In TM42, TM40, Base Unit Adapter**

Description • Operation • Maintenance

DOCNo 638500090

Release Date 99/ 07/ 01

Revision A

Revision Date 99/ 07/ 01



WARNING

- NEVER** USE THIS TERMINATOR IN A PRESS WITHOUT GUARDS OR SAFETY DEVICES THAT ARE INTENDED TO PREVENT INJURY. THE TERMINATOR IS SUPPLIED WITHOUT GUARDS. PLEASE USE GUARDS SUPPLIED WITH THE PRESS. RUNNING THE PRESS WITHOUT GUARDS UNDER ANY CIRCUMSTANCES CAN CAUSE SERIOUS INJURY.
- NEVER** INSTALL, OPERATE ADJUST, OR SERVICE THIS TERMINATOR WITHOUT PROPER INSTRUCTION AND WITHOUT FIRST READING AND UNDERSTANDING THE INSTRUCTIONS IN THIS MANUAL AND THE TM42 PRESS, TM40 PRESS, OR 3BF WITH BASE UNIT ADAPTER MANUALS.
- NEVER** INSTALL, REMOVE OR SERVICE TERMINATOR TOOLING WHILE THE FLYWHEEL IS IN MOTION OR POWER CONNECTED TO THE PRESS.
- NEVER** INSTALL, REMOVE OR SERVICE THE TERMINATOR TOOLING WITHOUT MANUALLY CYCLING THE PRESS TO VERIFY THAT THE CLUTCH CONTROL IS IN THE LOCKED POSITION PAST TOP DEAD CENTER, BLOCK THE RAM IN THE UP POSITION IF A DEFECTIVE CLUTCH IS SUSPECTED.
- CAUTION** THE PRESS SHOULD ALWAYS BE HAND CYCLED WITH THE TERMINATOR INSTALLED PRIOR TO RUNNING PRODUCTION. THIS PROCEDURE WILL PREVENT DAMAGE OR REDUCE TOOL WEAR.

WORK SAFELY AT ALL TIMES

**FOR SERVICE
CONTACT YOUR LOCAL SALES OFFICE**

**APPLICATION TOOLING GROUP
1150 DIEHL ROAD,
NAPERVILLE, ILLINOIS 60563**

**PH: (630) 969-4550
FAX: (630) 505-0049**



Molex Terminator

Table of Contents

Section

1. General Description
2. Installation - Setup - Operation
3. Maintenance

Appendix

- A. Terminator Types & T2 Assembly Drawing
- B. Crimp Definitions
- C. Statistical Process Control (Summary)



SECTION 1

General Description

	Page
1.1 Description.....	9
1.2 Features	9
1.3 Technical Specifications.....	9
1.4 Delivery Check.....	10
1.5 Tools	10
1.6 Safety & Work Area Check	10

Molex Presses and Adapters For “T” or “T2” Style Terminators

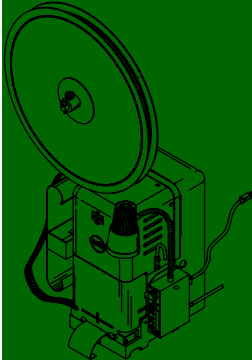

TM42 Press

- ISO Metric.
- Flexible external light.
- Resettable counter.
- 1.5" Stroke.

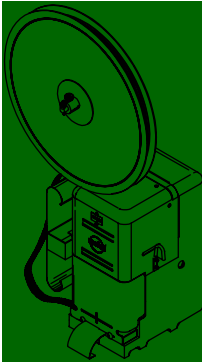

TM40 Press

- Internal Light.
- Non resettable counter.
- 1.0" Stroke.

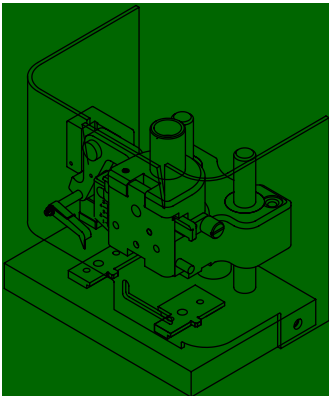

Base Unit Adapter

- Allows 3BF press to run Terminator style tooling.

General Description

1.1 Description

The Molex Terminator is an easy to use tool for the termination of a variety of Molex crimp terminals. Production flexibility is obtained through the use of simple interchangeable tooling. The tooling is inexpensive, and unlike a modular applicator, all crimp height and terminal feed adjustments are located in the press. The terminator die can be installed in the TM42, TM40 presses or Base Unit adaptor, and is ideally suited for mid-volume bench operation.

The Molex T2 terminator is the newer version tool that allows for track adjustment. It contains the identical perishable tooling as the Molex FineAdjust applicator. (Center carrier excluded)

1.2 Features

- Flexible and inexpensive.
- Enhanced crimping productivity.
- Simple installation.
- Quick release punches.
- T2 terminator has standardized tooling with Molex FineAdjust Applicator.
- Track Adjustment capabilities in the T2 terminators for improved control of the bellmouth size and cutoff tab length.

1.3 Technical Specifications

Dimensions

Width - 127.0 mm (5.0")

Depth - 44.0 mm (1.8")

Height - 25.0 mm (1")

Weight - 1.4 kg (3.0 lbs)

1.4 Delivery Check

	Qty
Terminator	1
Sample crimped terminals	5
Manual	1
Setup & Specification Documents	1

1.5 Tools

The following tools are recommended for setup and adjustments of the terminator tool.

1. Metric Allen Set
2. English Allen Set (for older terminator tools)
3. Large and Small Screwdriver
4. Crescent Wrench
5. Pliers (needle nose)
6. Crimp Micrometer
7. Eye Loop (10x)
8. Wire Stripper/ Cutter

1.6 Safety & Work Area Check

Check that the crimping position is ergonomic for the operator's size. A bench height of 762 to 813 mm (30 to 32 inches) will provide operator comfort, and allow both feet to rest on the ground. The foot pedal should be positioned for ease of reach.

Check that the press position is located parallel and approximately 150 mm (6 inches) from the edge of the table. A chair or stool, with adjustable height and backrest should be provided for maximum comfort and back support to the operator. Adjust press light to give appropriate visibility to the work area.

Check that the operators and observers are wearing approved safety goggles when the press is in operation and/ or service.

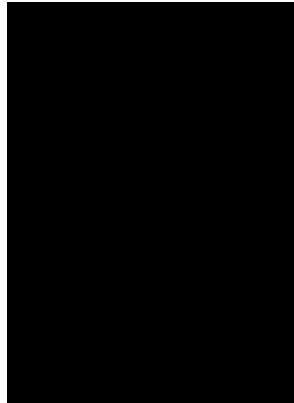



SECTION 2

Setup And Operation

	Page
2.1 Terminator Die Installation and Removal	13
2.2 Loading the Terminal Strip	15
2.3 Manually Cycling the Press	17
2.4 Punch and Anvil Alignment	19
2.5 Feed Finger Location	21
2.6 Forward and Back Feed Adjustment	23
2.7 Conductor Crimp Adjustment	25
2.8 Insulation Crimp Adjustment	27
2.9 Final Check and Operation	29

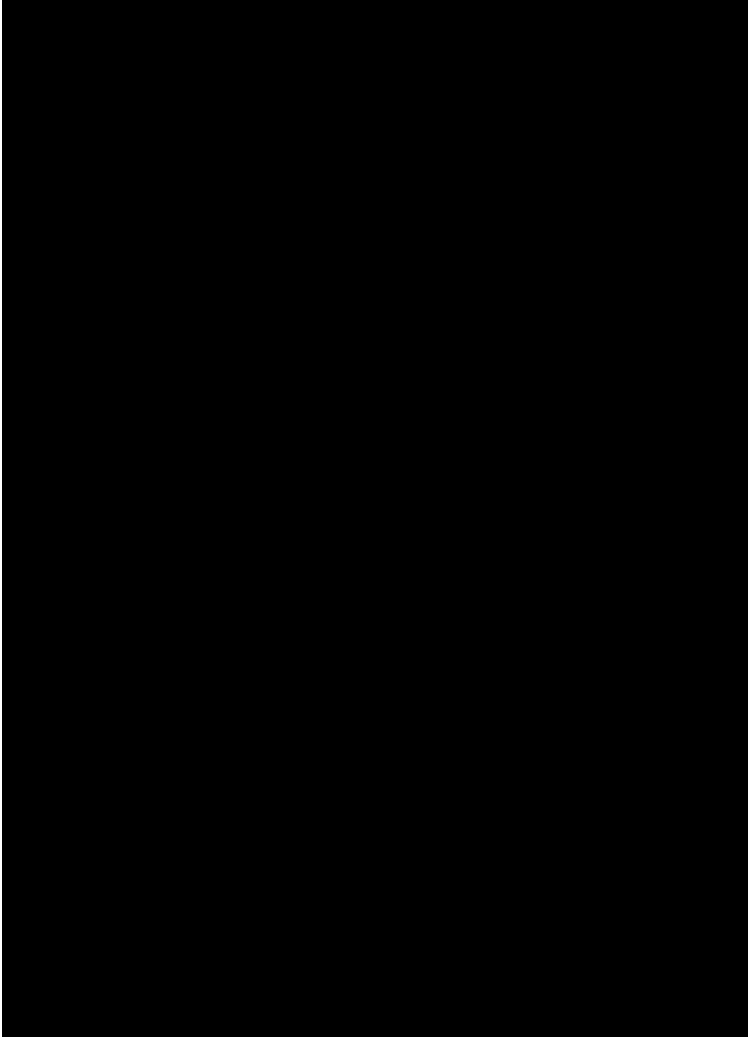

TERMINATOR INSTALLATION

Fig. 1

Terminator Die Installation & Removal

CAUTION

Always power down the press when installing or removing Molex tooling by pressing the emergency stop button located on the front panel.

STEPS (Ref. Fig. 1)

1. Remove Press guard. (Ref. Press or Base Unit manual.)
2. Confirm that the Terminator is correct for the specified product. (Ref. Specification sheets supplied with the Terminator.)
3. Make sure all the tooling from a previous setup is removed. (See Step 11.)
4. Load all top tooling first, starting with the rear striker. (See Fig. 16.)
5. Pull on punch release pin to install punches into the punch cavity.
6. Finish with front striker (if specified). Confirm that all components follow assembly drawing sequence.
7. Clean bolster plate of scrap or chips that may interfere with the Terminator base installation.
8. Remove 6 mm S.H.CS(TM42) and lift the right locating plate from the bolster.
9. Place the Terminator base on the bolster plate and slide to the left. The slot in the base will locate on the left guide block
10. Replace the right locating plate and tighten 6 mm screw.
11. To remove the Terminator reverse the above steps.

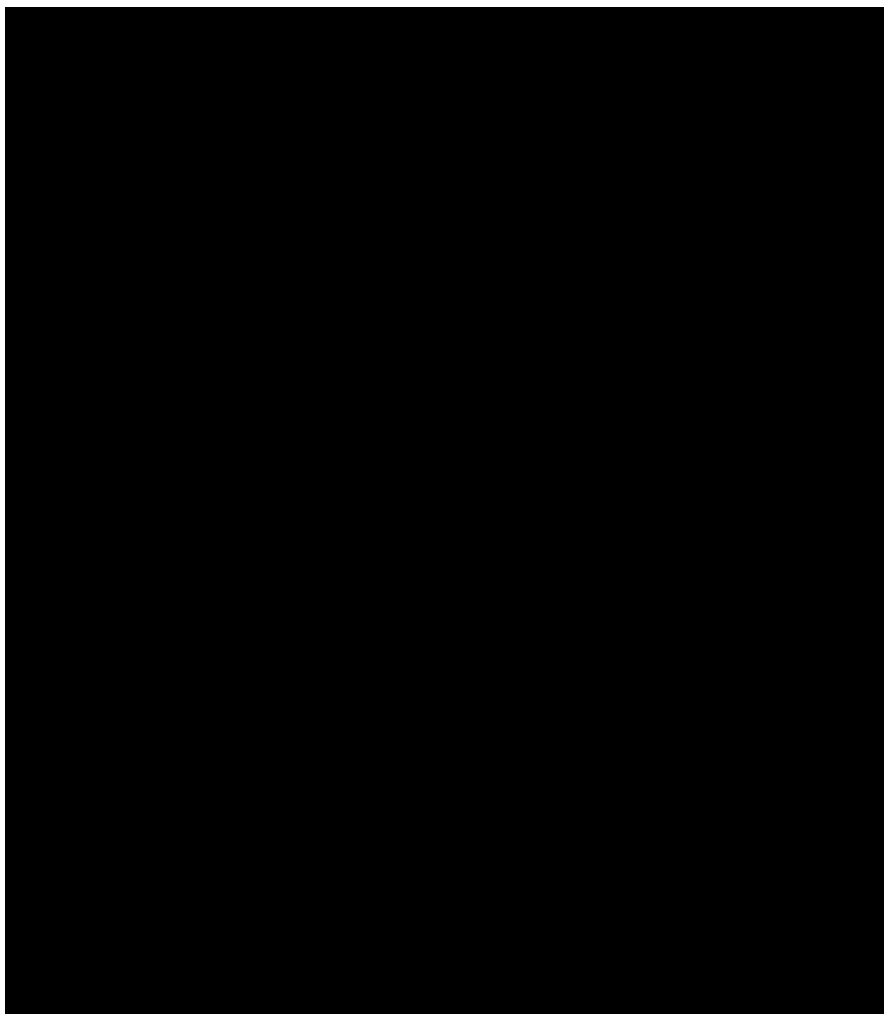

LOADING THE TERMINAL STRIP

Fig. 2

Loading The Terminal Strip

Note

Terminator Drag mechanism may vary on product selection or Terminator type.

Steps (Ref. Fig. 2)

1. Confirm terminal part number matches the terminator specification sheet.
2. Install the terminal reel on the press reel holder.
3. Raise the drag plate (T2) and slide the terminal strip under both the cover plate and the drag plate.
4. For other "T" style Terminators, raise the drag finger and anti backup finger.
5. Ease the terminal strip forward until the first terminal on the strip is sitting on the anvils.
6. If severe resistance is encountered or the terminal strip does not fit, you may need to make a cover plate adjustment.

Removing The Terminal Strip

Steps

1. Raise Terminal Drag plate or "T" style drag finger and anti backup finger.
2. Lift the Feed Finger from the carrier strip
3. Gently pull on the terminal strip until it has exited the track.

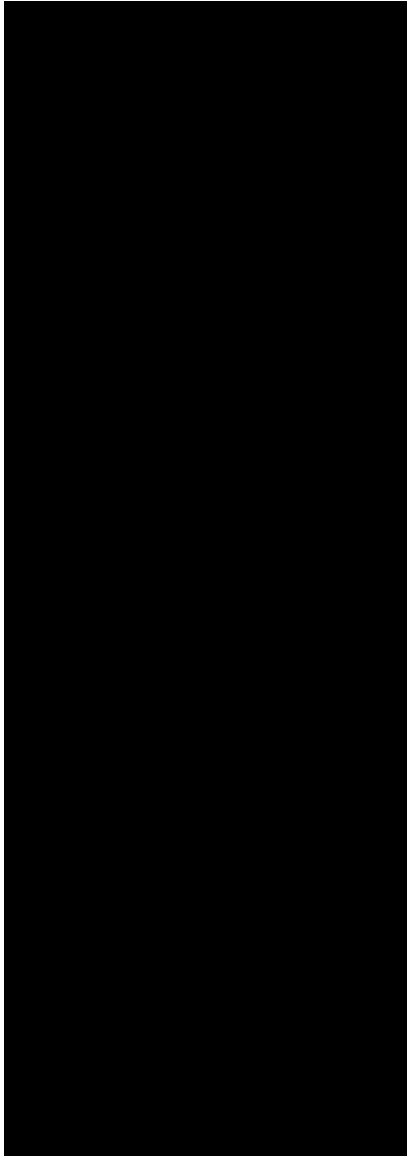

HAND CYCLING

Fig. 3

Manually Cycling the Press

Note

Hand cycling is necessary to confirm correct tool alignment, terminal feed adjustment, and also to give the setup person the ability to step through the press cycle manually.

Steps (Ref. Fig. 3)

1. Always power down the press by pressing the emergency stop button on the front control panel.
2. Release the clutch by inserting a screwdriver through the access hole to trip the locked actuator.
3. Insert the 10 mm hex wrench supplied with the press through the hole in the center of the rear cover and engage it in the 12 mm S.H.C.S.
4. Rotate the press flywheel to move the ram as desired.

WARNING

When the actuator is disengaged, the ram is free to drop. Due to the weight of the ram it is possible for the ram to start a downward movement.

Care must be taken to insure that the area in front of the press is clear of fingers and hand tools.

The guards should be in place or the ram blocked.

Never insert anything through the press guards while the flywheel is in motion.

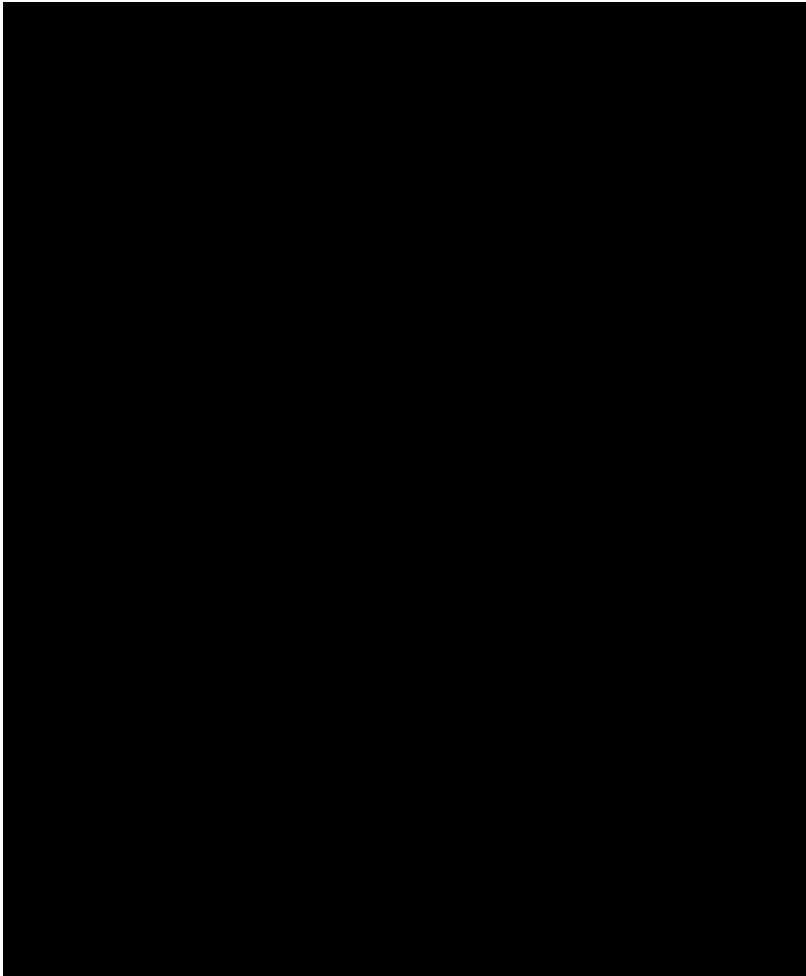

PUNCH & ANVIL ALIGNMENT

Fig. 4

Punch and Anvil Alignment

Note

Correct punch and anvil alignment will insure quality crimps and excellent tool life.

Steps (Ref. Fig. 4)

1. Slightly loosen the anvil mounting screws.
2. Place the hand cycling wrench through the hole in the center of the rear cover.
3. Gently lower the press ram until it is in the fully down position, with a terminal sitting on the the anvils the punch will align the bottom tooling.
4. With the ram in the fully down position tighten the anvil mounting screws.
5. Bring the ram back to top dead center insuring that the dutch collar is engaged by the actuator.
6. Repeat the hand cycling operation to confirm alignment.



FEED FINGER LOCATION

Fig. 5

Feed Finger Location Adjustment

Note

Feed finger location will vary depending on product selections see the feed finger location chart. (Ref. Fig. 5)

Steps (Ref. Fig. 5.1)

1. Select feed finger position.
2. Loosen the feed finger shaft locking screw and position the feed finger in the selected position.
3. With a small screwdriver or 6" scale rotate the feed finger shaft to increase the spring pressure on the feed finger.
4. While maintaining the spring pressure on the feed finger, tighten the feed finger locking screw.

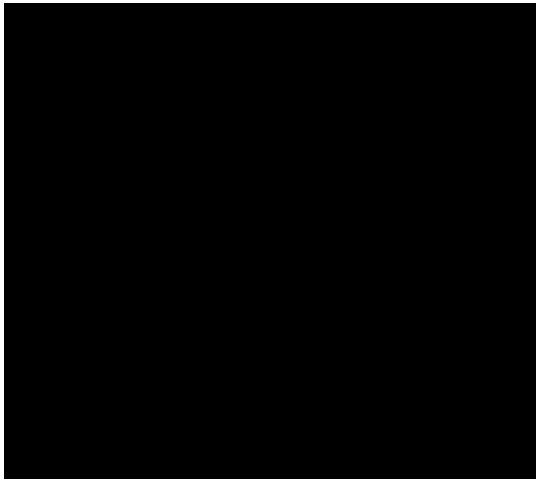

FEED FINGER SPRING ADJUSTMENT

Fig. 5.1

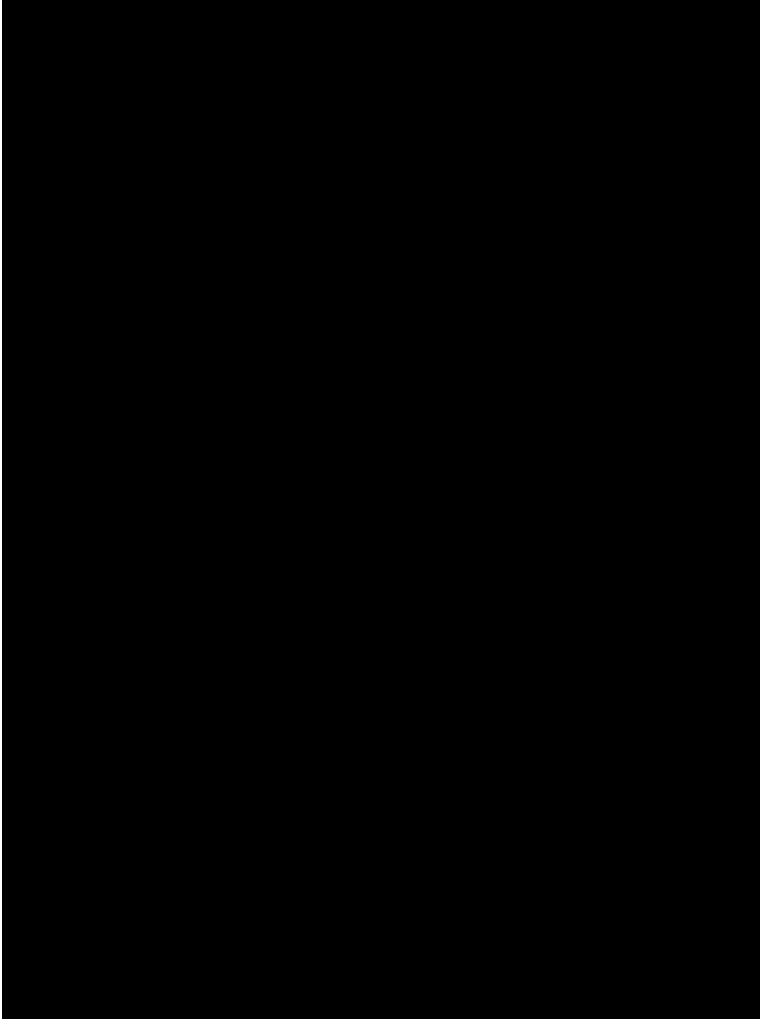

FORWARD AND BACKFEED ADJUSTMENT

Fig. 6

Forward and Back Feed Adjustment

Note

Because of different terminal progressions, feed adjustment may be necessary.

Steps (Ref. Fig. 6)

1. Make sure the press ram is in the fully up position and the dutch collar is engaged by the actuator.
2. Slide the terminal carrier strip all the way forward until it is centered over the anvils.
3. See the feed finger location (Fig. 5) for feed finger position.
4. Rotate the feed finger shaft with small screwdriver or 6" scale to get desired feed finger spring pressure and tighten shaft locking screw.
5. Loosen 6 mm feed adjustment wheel locking screw.
6. Turn the feed adjustment wheel if necessary to position the terminal over the anvils.
7. Place the 10 mm hex head Allen wrench in the 12 mm S.H.C.S. located in the back of the press and slowly hand cycle the press to the fully down position.
8. The feed finger should start to move backward one progression, if not loosen the 6 mm jam nut and back the set screw out enabling the feed finger to move to the next pick up point.
9. If the feed finger is moving back more than one progression rotate the 6 mm set screw clockwise until the feed finger is in the correct pickup point.
10. Hand cycle the press ram a few times and if necessary make the appropriate adjustments.
11. Tighten M6 lock nut and 6 mm feed adjustment locking screw.

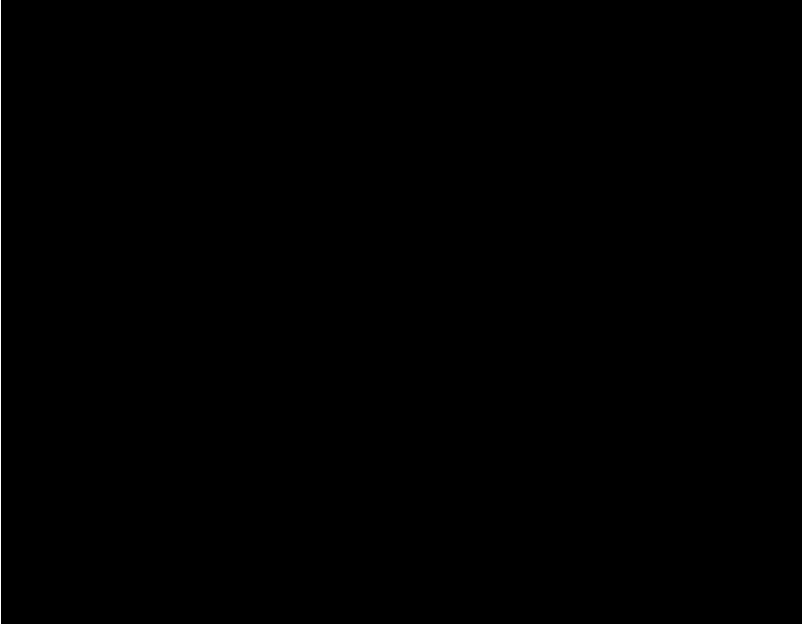

CONDUCTOR HEIGHT ADJUSTMENT

Fig. 7

Conductor Height Adjustment

Note

It is desirable to adjust the conductor adjustment wheel all the way to (1) on the conductor adjustment indicator, to avoid punch crash prior to beginning this process.

Steps (Ref. Fig. 7)

1. Replace the press guard.
2. Prepare wire for crimping. The selected wire should meet the parameters on the specification sheet.
3. Make sure that the 10 mm hex head Allen wrench is removed from the back of the press.
4. Turn the power on.
5. Place the wire through the slot in the press guard and all the way to the Terminator wire stop.
6. Activate the foot pedal, sweeping the crimped wire to the right.
7. Measure the crimped wire and verify desired crimp height on the specification sheet.
8. If crimp height adjustments are required, power down the press and remove the press guard.
9. Loosen the 6 mm crimp height locking screw and rotate conductor adjusting screw. Rotating the conductor adjusting screw clockwise one full turn will tighten the crimp height approximately 0.03mm (.001").
10. Repeat steps 1 thru 9 until the correct crimp height is achieved.
11. When correct crimp height is achieved tighten 6 mm lock screw.
12. Replace the press guard.



INSULATION CRIMP ADJUSTMENT

Fig. 8

Insulation Crimp Adjustment

Note

The insulation crimp provides strain relief for the conductor crimp. The quality of the insulation crimp will depend on the insulation diameter and durometer. Refer to the specification sheet for insulation diameter parameters.

Steps (Ref. Fig. 8)

1. Place a stripped wire against the wire stop, crimp it under power.
2. Inspect the sample to determine if adjustments are needed.
3. If adjustments are needed powers down the press by pressing the emergency stop the button located in the front of the control panel.
4. Remove the press guard.
5. Rotate the insulation adjusting cam to obtain the required insulation wrap.
6. Rotate the insulation adjusting cam, counter clockwise to tighten the insulation wrap.
7. Each increment represents approximately 0.1mm (.004).
8. Beginning at # 1 (loosest) to # 8 (tightest) insulation crimp.
9. Replace the press guard.
10. Repeat the above steps until the desired insulation crimp is obtained.

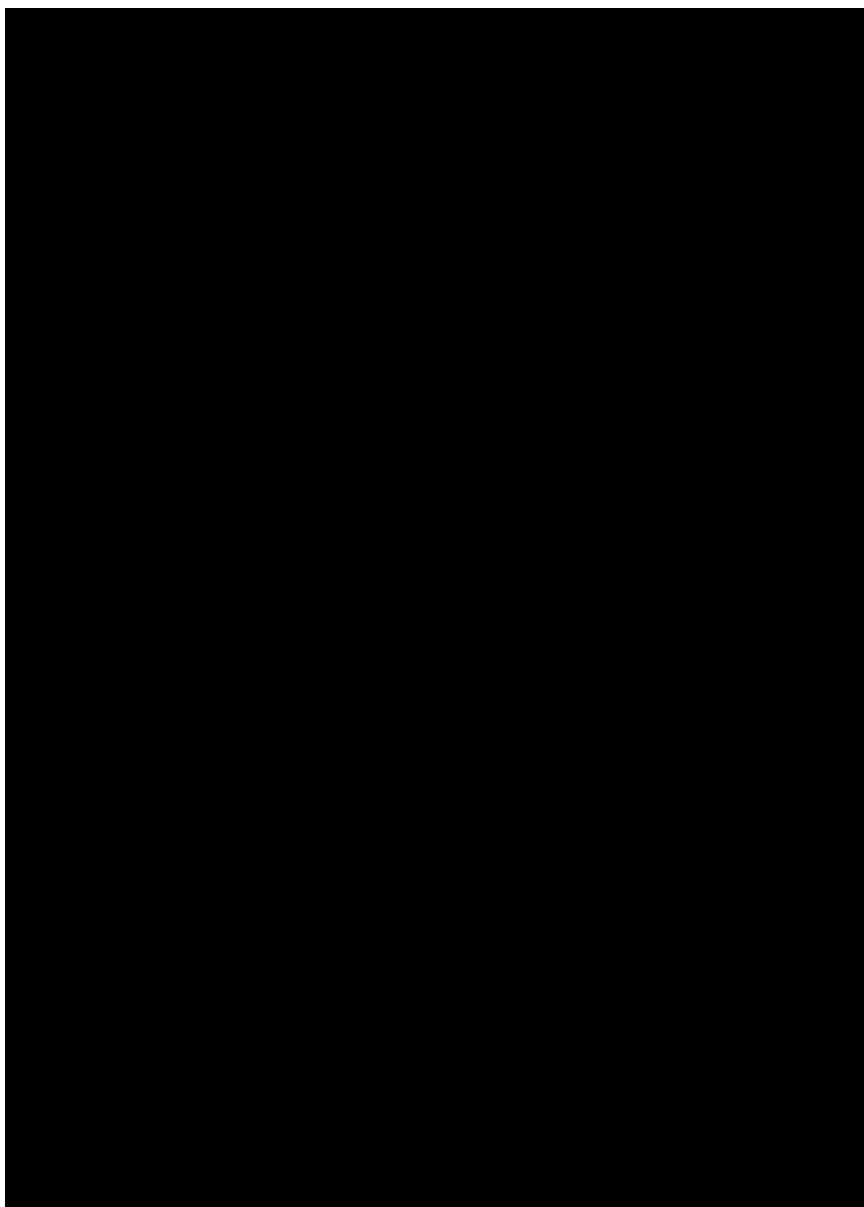

OPERATION

Fig. 9

Operation

Note

Check that all setup procedures were followed and all locking screws have been tightened. Follow the safety and work area instructions.

Steps (Ref. Fig. 9)

1. Press guard should be in position.
2. Wire should be pre stripped and prepared for crimping.
3. Place pre stripped wire through the slot in the press guard.
4. Touch pre-stripped wire against the wire stop.
5. Press foot pedal down once.
6. Use sweeping motion to the right with the crimped wire.
7. Check the crimped wire and confirm that it meets the Terminator specifications and visual inspection.

SECTION 3

Maintenance

Note

Terminator maintenance will increase tool life and produce a consistent, reliable quality crimp. The following procedure should be followed at the end of each operation.

Steps

1. Power down the press.
2. Remove the press guard.
3. Make sure that the dutch collar is engaged by the dutch actuator.
4. Take a small brush and dean in and around the terminator anvils.
5. Inspect perishable tooling for wear or fracture.

Molex recommends that you maintain a spare tooling kit at your facility.

The Terminator should be free of all carrier strip tabs and plating that may have accumulated during production.

Terminator Types

Note

Molex supplies different types of Terminators depending on the vintage. The following illustrations are a generic guide to the Tool that you may have.

1. Track Adjustment Fig. 10
2. End carrier T2 Fig. 11
3. Dual carrier T2 Fig. 12
4. Center carrier "T" Fig. 13
5. Micro terminal "T" Fig. 14
6. T2 Terminator Assembly Fig. 15
7. Rear Striker Installation Fig. 16

T2 Terminator

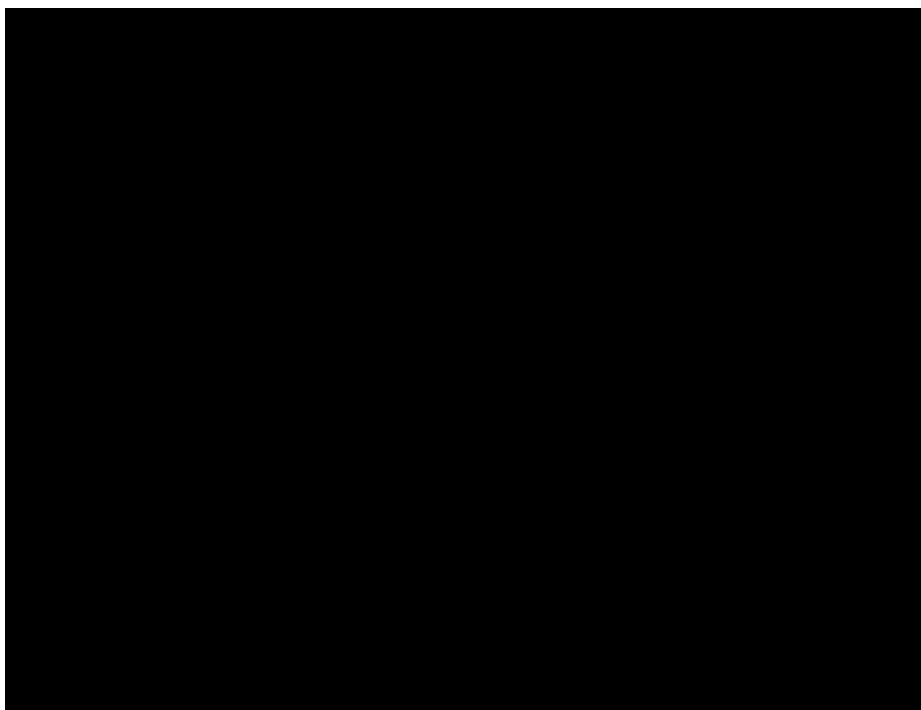

T2 TERMINATOR

Fig. 10

Track Adjustment T2 Series

The T2 Terminator allows for adjustment of both the bellmouth and cut-off tab by loosening the 6 mm S.H.C.S and moving the terminator track in or out to achieve desired conditions on crimp.

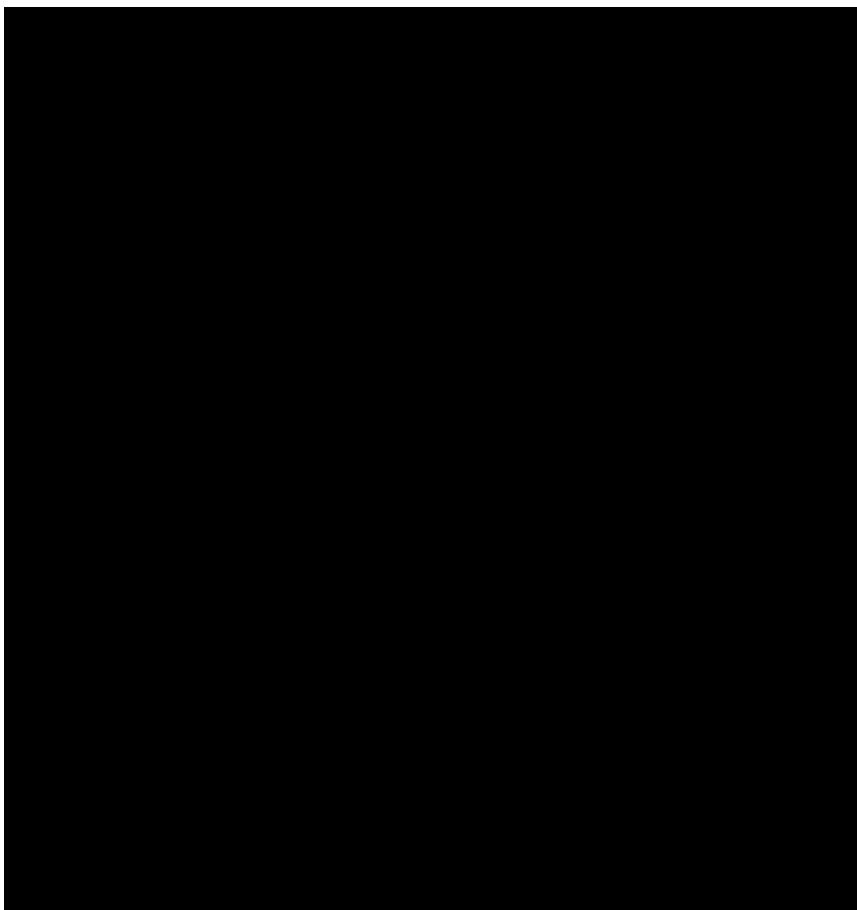

T2 END CARRIER (GENERIC)

Fig. 11



T2 DUAL CARRIER (GENERIC)

Fig. 12

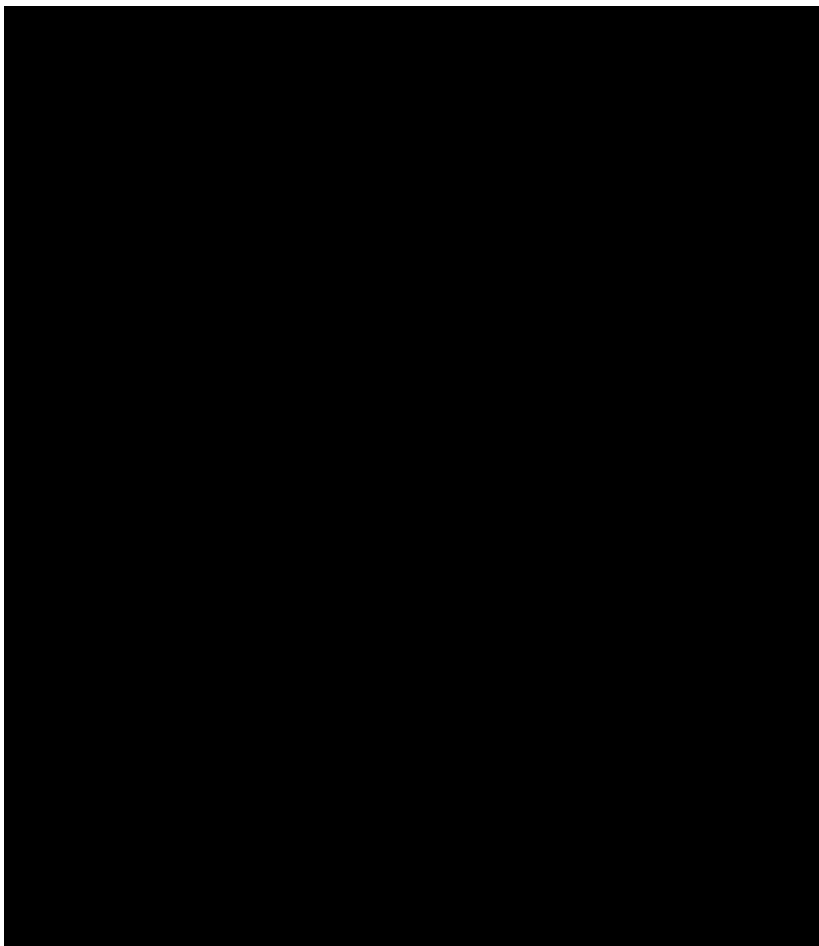

T' STYLE CENTER CARRIER (GENERIC)

Fig. 13

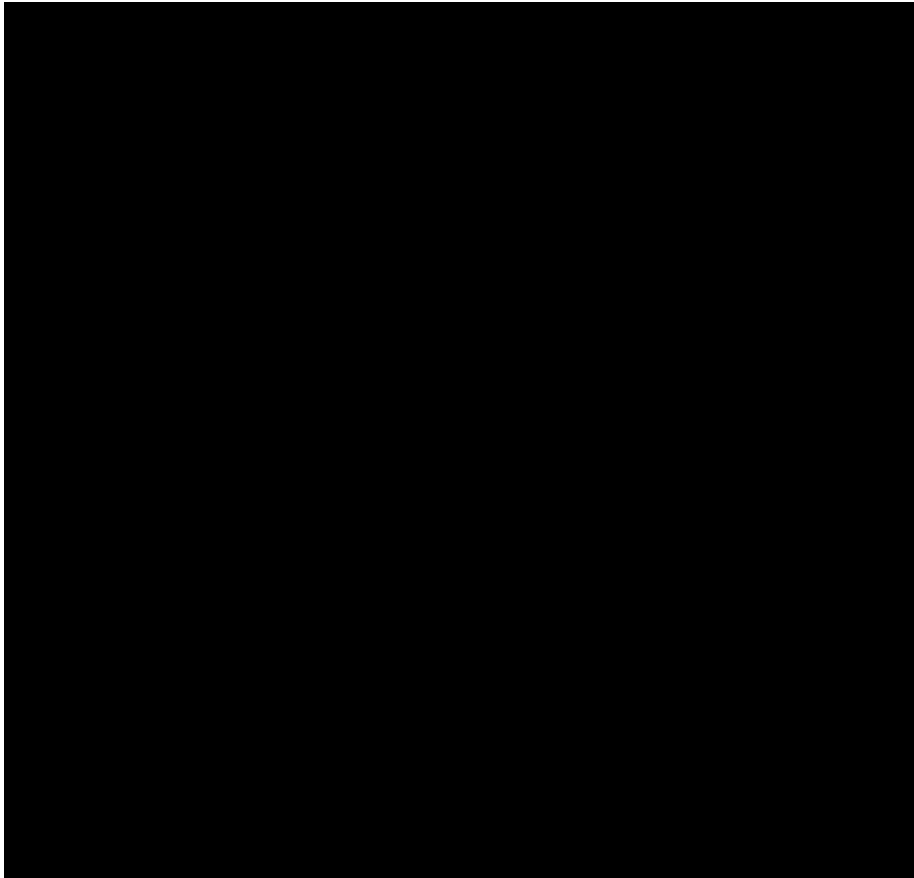

MICRO TERMINAL (GENERIC)

Fig. 14

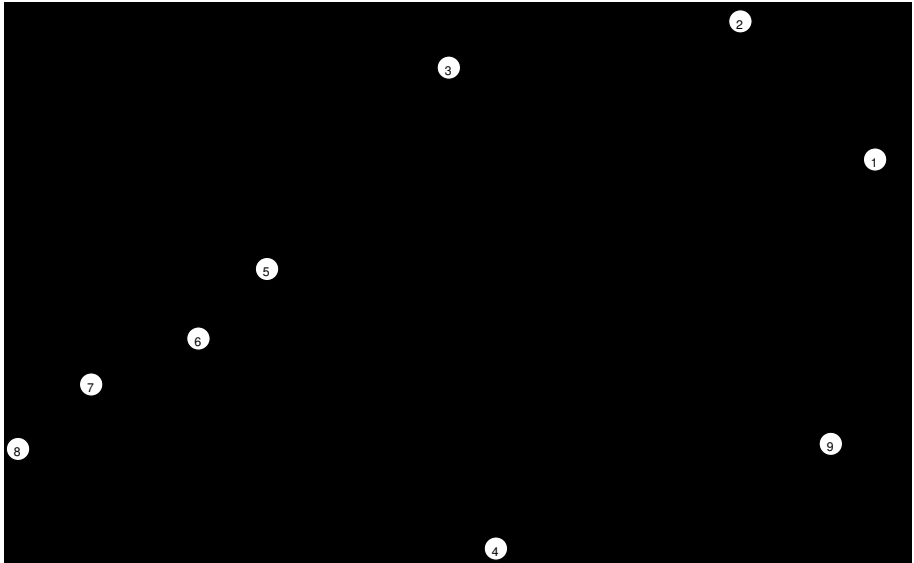

T2 Terminator Bill of Materials

Item No.	Order No.	Description	Qty.
1	638008501	T2 Terminator Base	1
2	638000108	Terminal Track	1
3	690280660	Drag Springs	2
4	638000316	Guide Pin-Drag Frame	2
5	638000312	Drag Frame	1
6	638000115	Spacer Tube	1
7	638000313	Drag Cam	1
8		M4 x 12 Lg. B.H.C.S.	1
9		M5 x 10 Lg. S.H.C.S.	1

T2 TERMINATOR ASSEMBLY

Fig. 15

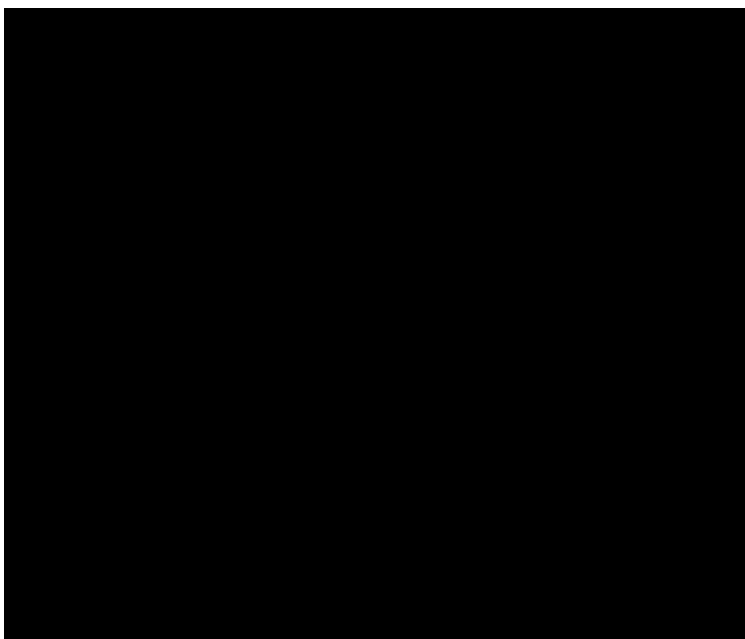

REAR STRIKER INSTALLATION

Fig. 16

Crimp Terminations

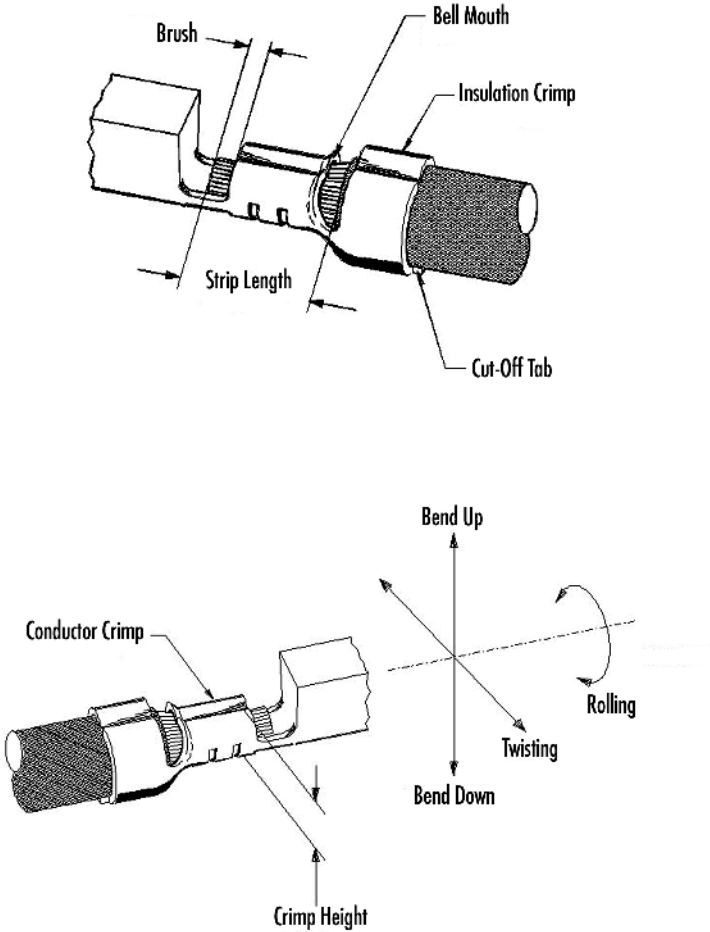

Definitions

Anatomy Of A Crimp Termination

Bellmouth (Flare)

The flare that is formed on the edge of the conductor crimp acts as a funnel for the wire strands. The funnel reduces the possibility that a sharp edge on the conductor crimp will cut or nick the wire strands.

Bend Up / Bend Down / Twisting / Rolling

The terminal bending up, bending down, twisting or rolling indicates that the nose of the terminal is reacting to the crimping process.

Brush

The conductor brush is made up of wire strands that extend past the conductor crimp.

Conductor Crimp

This is the metallurgical compression of a terminal around the wire's conductor.

Crimp Height

The conductor crimp height is measured from the top surface of the formed crimp to the bottom most radial surface.

Cut-Off Tab Length

This is the material that protrudes outside the insulation crimp after the terminal is separated from the carrier strip.

Insulation Crimp

The insulation crimp provides a strain relief for the crimped wire and support for insertion into the housing.

Strip Length

The strip length is the pre determined amount of bare wire that is exposed for crimping.

Statistical Process Control (Summary)

Process Confirmation.

Molex recommends that prior to production, a 25 piece process capability study on both crimp height and pull force.

Setup/ Visual Inspection

Minimum 5 piece sample should be checked for crimp height per specification sheet.

Visually check bellmouth, conductor brush, insulation position, cutoff tab length and insulation crimp to specification sheet guidelines for optimum setup.

Production

Visual check every bundle by fanning the crimped wires.

Check crimp height every 250- 500 pieces.

Molex recommends control charting of crimp heights for long production runs.

Example Control Chart

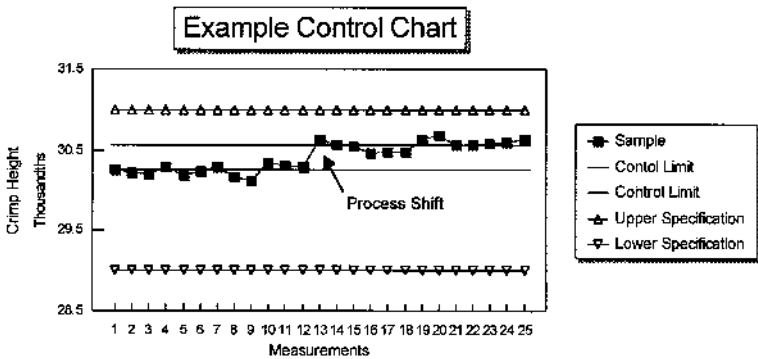

X & R Chart

Control Limit for sample of 5 = Avg (Avg of 5 readings) + .577 x Avg (Ranges)

Note: For more detail information please refer to the Molex Quality Crimping Handbook, Order No. 63800-0029.

Terminator Crimping Manual



Corporate Headquarters

2222 Wellington Court
Lisle, IL, 60532, U.S.A
Tel : 630-969-4550

Application Tooling Division

1150 E. Diehl Rd
Naperville, IL, 60563
Tel : 630-969-4550

European Headquarters

Munich, Germany
Tel : 49-89-413092-0

Far East North Headquarters

Kanagawa, Japan
Tel : 81-462-2324

Far East South Headquarters

Jurong Town, Singapore
Tel : 65-268-6868