

AT-41535

Up to 6 GHz Low Noise Silicon Bipolar Transistor



Data Sheet

Description/Applications

The AT-41535 of Avago Technologies is a general purpose NPN bipolar transistor that offers excellent high frequency performance. The AT-41535 is housed in a cost effective surface mount 100 mil micro-X package. The 4 micron emitter-to-emitter pitch enables this transistor to be used in many different functions. The 15 emitter fingers interdigitated geometry yields an intermediate sized transistor with impedances that are easy to match for low noise and moderate power applications. This device is designed for use in low noise, wideband amplifier, mixer and oscillator applications in the VHF, UHF, and microwave frequencies. An optimum noise match near 50 Ω at 1GHz, makes this device easy to use as a low noise amplifier.

The AT-41535 bipolar transistor is fabricated using Avago Technologies' 10 GHz fT Self-Aligned-Transistor (SAT) process. The die is nitride passivated for surface protection. Excellent device uniformity, performance and reliability are produced by the use of ion implantation, self-alignment techniques, and gold metallization in the fabrication of this device.

Features

- Low Noise Figure :
 - 1.7 dB typical at 2.0 GHz
 - 3.0 dB typical at 4.0 GHz
- High Associated Gain
 - 14.0 dB typical at 2.0GHz
 - 10.0 dB typical at 4.0 GHz
- High Gain-Bandwidth Product
 - 8.0 GHz typical fT
- Cost Effective Ceramic Micro-strip Package

35 micro-X Package

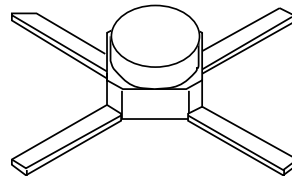

Table 1. Absolute Maximum Ratings [1] at Tc = +25°C

Symbol	Parameter	Unit	Max Rating
V _{EBO}	Emitter-Base Voltage	V	1.5
V _{CBO}	Collector-Base Voltage	V	20
V _{CEO}	Collector-Emitter Voltage	V	12
I _C	Collector Current	mA	60
P _T	Power Dissipation ^[2]	mW	500
T _J	Junction Temperature	°C	150
T _{stg}	Storage Temperature	°C	-60 to 150
θ _{jc}	Thermal Resistance ^[5]	°C/W	125

Notes:

1. Operation in excess of any one of these conditions may result in permanent damage to the device.
2. T—CASE = 25°C
3. Derate at 8 mW/°C for T_c>87.5°C.
4. Storage above +150°C may tarnish the leads of this package making it difficult to solder into a circuit.
5. Thermal Resistance is measured using IR Microscopy method.

Table 2. Electrical Specifications at Tc = +25°C, V_{CE}=8V

Symbol	Parameter and Test Condition	Units	Min.	Typ.	Max.
S _{21E} ²	Insertion Power Gain; V _{CE} =8V, I _C =25mA	f = 2.0 GHz f = 4.0 GHz	dB	11.0 5.5	
P _{1dB}	Power Output @1dB Gain Compression: V _{CE} =8V, I _C =25 mA	f = 2.0 GHz f = 4.0 GHz	dBm	19.0 18.5	
G _{1dB}	1 dB Compressed Gain: V _{CE} =8V, I _C =25 mA	f = 2.0 GHz f = 4.0 GHz	dB	14.0 9.0	
N _{Fo}	Optimum Noise Figure: V _{CE} =8V, I _C = 10 mA	f = 1.0 GHz f = 2.0 GHz f = 4.0 GHz	dB	1.30 1.70 3.00	2.0
G _A	Gain @ N _{Fo} ; V _{CE} =8V, I _C =10mA	f = 1.0 GHz f = 2.0 GHz f = 4.0 GHz	dB	13.0 18.0 14.0 10.0	
f _T	Gain Bandwidth Product: I _C = 25 mA		GHz	8.0	
h _{FE}	Forward Current Transfer Ratio: V _{CE} =8V, I _C = 10 mA		-	30 180	270
I _{CBO}	Collector Cutoff Current: V _{CB} = 8 V		uA		0.2
I _{EBO}	Emitter Cutoff Current: V _{EB} = 1 V		uA		1.0
C _{CBO}	Collector Base Capacitance ^[1] : V _{CB} =8V, F=1 MHz		pF	0.20	

Notes:

1. For this test, the emitter is grounded.

Typical Performance Curves at Tc = +25°C

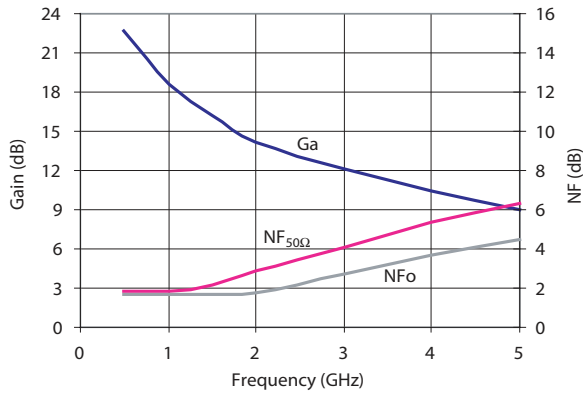

Figure 1. Noise Figure and Associated Gain vs. Frequency. Vce = 8V, Ic = 10mA

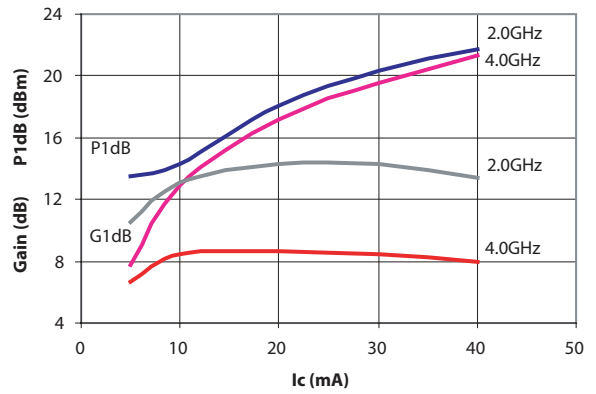

Figure 2. Output Power and 1dB Compression Gain vs. Collector Current and Frequency. Vce = 8V.

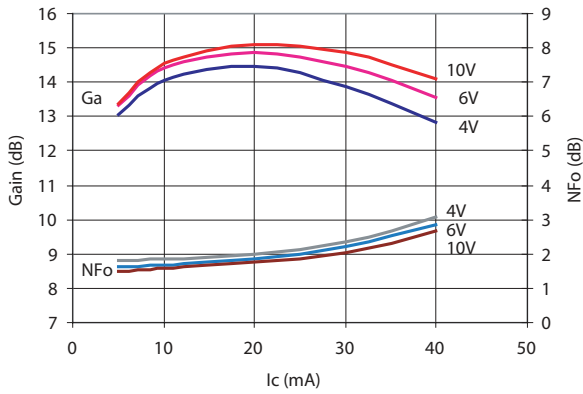

Figure 3. Optimum Noise Figure and Associated Gain vs. Collector Current and Collector Voltage. F = 2.0GHz.

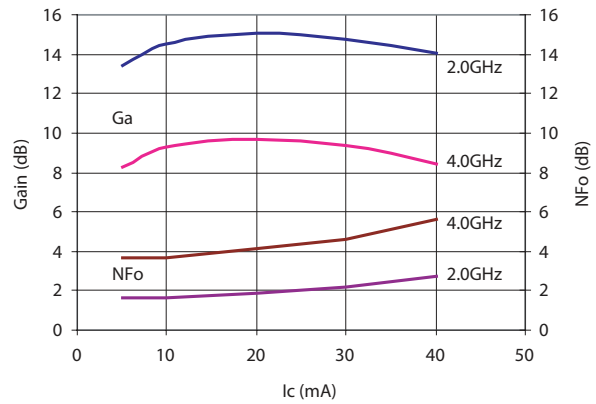

Figure 4. Optimum Noise Figure and Associated Gain vs. Collector Current and Frequency. Vce = 8V.

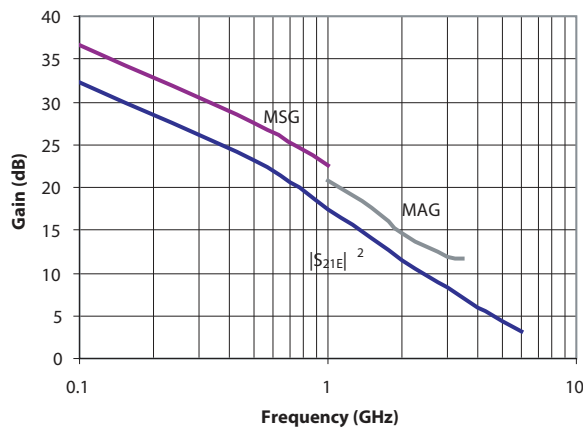

Figure 5. Insertion Power Gain, Maximum Available Gain and Maximum Stable Gain vs. Frequency. Vce = 8V, Ic = 25mA

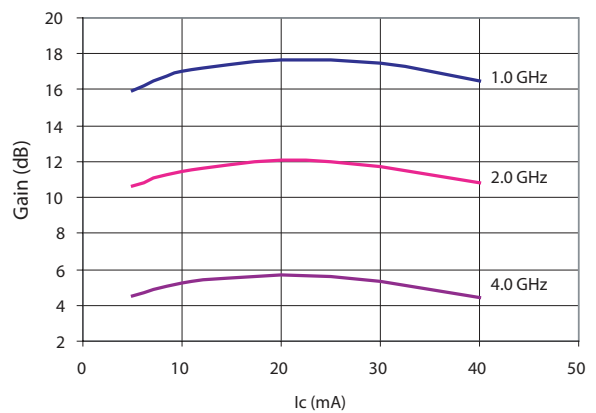

Figure 6. Insertion Power Gain vs. Collector Current and Frequency. Vce = 8V.

Typical Scattering Parameters at Tc = +25°C

Common Emitter, V_{CE}=8V, I_c = 10mA, Z_o=50 Ohm

Freq.	S11			S21			S12			S22	
GHz	Mag.	Ang.	dB	Mag.	Ang.	dB	Mag.	Ang.	Mag.	Ang.	
0.1	0.780	-32.6	28.01	25.151	156.9	-40.00	0.010	81.4	0.943	-11.3	
0.5	0.495	-112.1	21.90	12.446	108.0	-30.46	0.030	52.0	0.635	-25.3	
1	0.402	-154.7	16.64	6.795	85.0	-26.94	0.045	56.0	0.544	-27.3	
1.5	0.388	172.7	13.35	4.651	71.0	-24.58	0.059	59.6	0.517	-29.2	
2	0.400	162.3	10.97	3.536	60.2	-22.62	0.074	59.0	0.497	-34.1	
2.5	0.426	152.3	9.21	2.889	53.5	-21.11	0.088	62.6	0.478	-36.7	
3	0.461	141.7	7.75	2.440	43.8	-19.33	0.108	63.0	0.467	-44.4	
3.5	0.482	134.5	6.50	2.113	34.2	-18.13	0.124	60.6	0.467	-53.4	
4	0.493	125.8	5.47	1.877	25.6	-16.77	0.145	57.1	0.481	-61.9	
4.5	0.494	114.1	4.67	1.711	14.8	-15.34	0.171	53.2	0.504	-68.9	
5	0.491	104.2	3.80	1.548	5.7	-14.38	0.191	50.9	0.517	-74.3	
5.5	0.515	91.9	3.11	1.431	-3.5	-13.35	0.215	44.8	0.503	-79.6	
6	0.581	82.6	2.56	1.342	-13.0	-12.40	0.240	40.9	0.457	-90.2	

Typical Scattering Parameters at Tc = +25°C

Common Emitter, V_{CE}=8V, I_c = 25mA, Z_o=50 Ohm

Freq.	S11			S21			S12			S22	
GHz	Mag.	Ang.	dB	Mag.	Ang.	dB	Mag.	Ang.	Mag.	Ang.	
0.1	0.586	-53.5	32.22	40.842	145.1	-40.92	0.009	82.1	0.850	-17.4	
0.5	0.382	-140.8	23.11	14.306	98.4	-32.04	0.025	61.9	0.528	-22.8	
1	0.358	-174.2	17.40	7.416	79.6	-27.74	0.041	68.9	0.487	-23.2	
1.5	0.362	167.6	13.98	5.003	67.7	-23.88	0.064	67.4	0.467	-27.4	
2	0.385	152.4	11.57	3.789	57.9	-22.05	0.079	64.8	0.448	-31.4	
2.5	0.408	145.5	9.79	3.086	52.3	-20.00	0.100	64.8	0.428	-34.7	
3	0.442	137.0	8.32	2.605	43.6	-18.71	0.116	65.9	0.418	-43.2	
3.5	0.463	130.0	7.09	2.262	34.0	-17.27	0.137	61.2	0.426	-52.3	
4	0.484	121.4	6.03	2.003	25.4	-16.08	0.157	58.4	0.431	-60.8	
4.5	0.476	110.5	5.24	1.828	15.5	-14.99	0.178	52.2	0.461	-68.6	
5	0.462	101.3	4.33	1.647	6.4	-14.11	0.197	48.1	0.466	-72.8	
5.5	0.495	90.1	3.73	1.537	-1.8	-13.00	0.224	42.8	0.454	-79.2	
6	0.563	80.5	3.10	1.429	-11.6	-12.04	0.250	36.9	0.396	-89.2	

Typical Noise Parameters at Tc = +25°C

V_{CE}=8V, I_c = 10mA, Z_o=50 Ohm

Freq.GHz	NfodB	Γ _{opt}		
		Mag	Ang	RN/50
0.1	1.30	0.184	-4.1	0.22
0.5	1.33	0.206	9.5	0.21
1	1.42	0.107	15.8	0.20
2	1.73	0.328	-165.5	0.18
4	2.92	0.557	-128.3	0.27

Part Number Ordering Information

Part number	No of Devices
AT-41535G	100

35 micro-X Package Dimensions

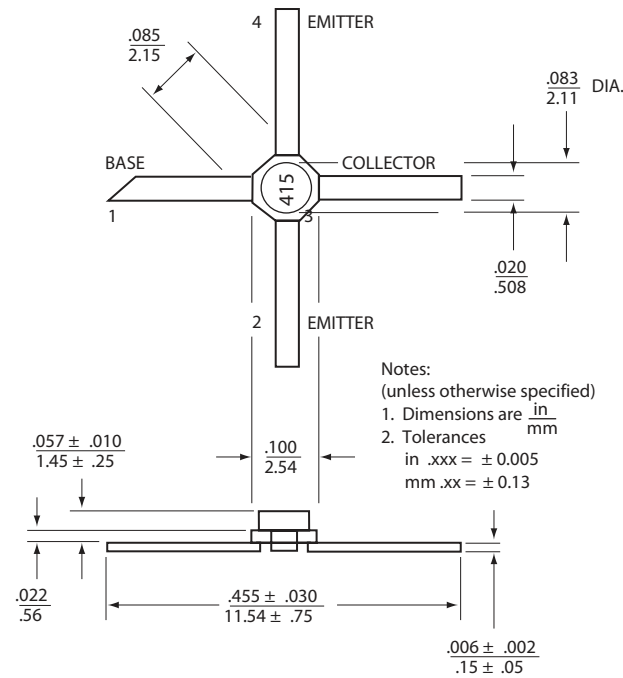

For product information and a complete list of distributors, please go to our web site:

www.avagotech.com

Avago, Avago Technologies, and the A logo are trademarks of Avago Technologies Limited in the United States and other countries. Data subject to change. Copyright © 2005-2008 Avago Technologies Limited. All rights reserved. Obsoletes AV01-0144EN AV02-1216EN - April 29, 2008

Avago
TECHNOLOGIES