

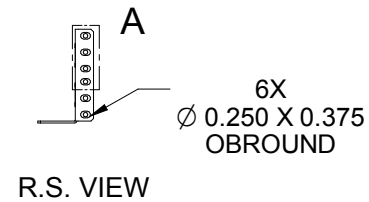

**ISOMETRIC**  
Sold with 2 Right and 2 Left

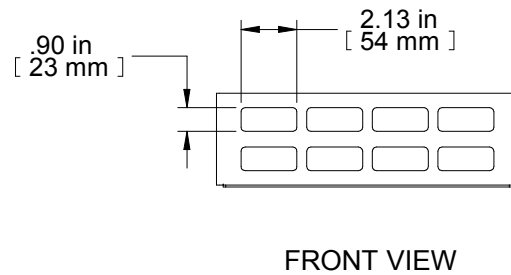
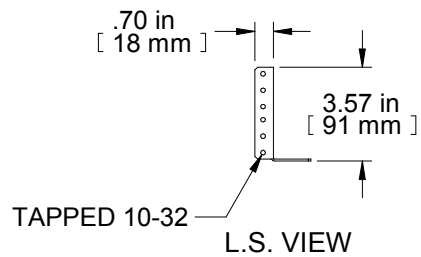
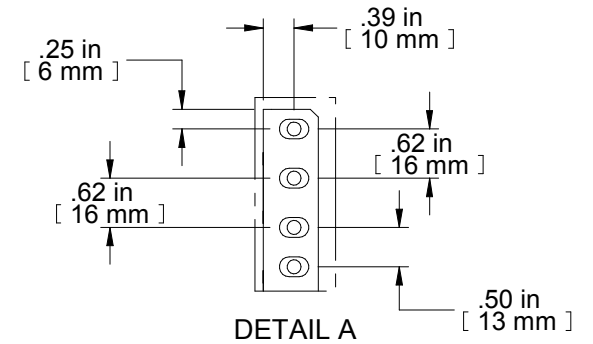
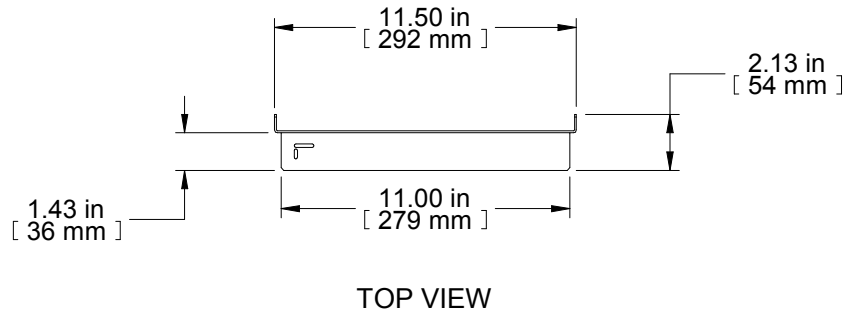

<b>PART NUMBERS</b>	
RDAB2U26	PAINTED BLACK SMOOTH
<b>NOTES</b>	
Sold in Pairs of 2 Right and 2 Left	
10-32 x 5/8 Pan Head Screw (Qty. 8) Incd.	
See Hammond Website for More Information	
<b>Français</b>	
Pour tous les détails sur nos produits, svp veuillez consulter notre site <a href="http://www.hammondmfg.com">www.hammondmfg.com</a>	
Data subject to change without notice. Isometric drawing not to scale. Les données sont sujettes à changement sans préavis.	
	<b>HAMMOND MANUFACTURING®</b>
	<a href="http://www.hammondmfg.com">www.hammondmfg.com</a>
	<b>PART NO. RDAB2U26</b>