

## LMH6639 190MHz Rail-to-Rail Output Amplifier with Disable

Check for Samples: [LMH6639](#)

### FEATURES

- ( $V_S = 5V$ , Typical Values Unless Specified)
- Supply Current (No Load) 3.6mA
- Supply Current (Off Mode) 400 $\mu$ A
- Output Resistance (Closed Loop 1MHz) 0.186 $\Omega$
- -3dB BW ( $A_V = 1$ ) 190MHz
- Settling Time 33nsec
- Input Common Mode Voltage -0.2V to 4V
- Output Voltage Swing 40mV from Rails
- Linear Output Current 110mA
- Total Harmonic Distortion -60dBc
- Fully Characterized for 3V, 5V and  $\pm 5V$
- No Output Phase Reversal with CMVR Exceeded
- Excellent Overdrive Recovery
- Off Isolation 1MHz -70dB
- Differential Gain 0.12%
- Differential Phase 0.045°

### APPLICATIONS

- Active Filters
- CD/DVD ROM
- ADC Buffer Amplifier
- Portable Video
- Current Sense Buffer

### DESCRIPTION

The LMH6639 is a voltage feedback operational amplifier with a rail-to-rail output drive capability of 110mA. Employing TI's patented VIP10 process, the LMH6639 delivers a bandwidth of 190MHz at a current consumption of only 3.6mA. An input common mode voltage range extending to 0.2V below the  $V^-$  and to within 1V of  $V^+$ , makes the LMH6639 a true single supply op-amp. The output voltage range extends to within 30mV of either supply rail providing the user with a dynamic range that is especially desirable in low voltage applications.

The LMH6639 offers a slew rate of 172V/ $\mu$ s resulting in a full power bandwidth of approximately 28MHz. The LMH6639 also offers protection for the input transistors by using two anti-parallel diodes and a series resistor connected across the inputs. The  $T_{ON}$  value of 83nsec combined with a settling time of 33nsec makes this device ideally suited for multiplexing applications (see application note for details). Careful attention has been paid to ensure device stability under all operating voltages and modes. The result is a very well behaved frequency response characteristic for any gain setting including +1, and excellent specifications for driving video cables including harmonic distortion of -60dBc, differential gain of 0.12% and differential phase of 0.045°

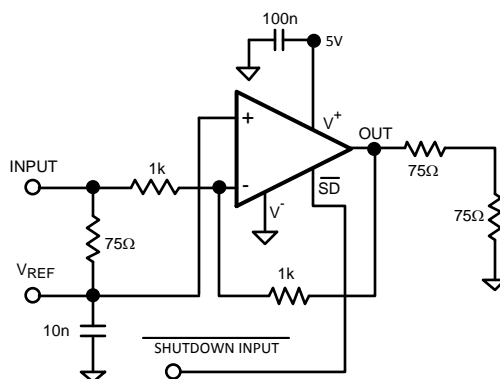

Figure 1. Typical Single Supply Schematic



Please be aware that an important notice concerning availability, standard warranty, and use in critical applications of Texas Instruments semiconductor products and disclaimers thereto appears at the end of this data sheet.

All trademarks are the property of their respective owners.



These devices have limited built-in ESD protection. The leads should be shorted together or the device placed in conductive foam during storage or handling to prevent electrostatic damage to the MOS gates.

### Absolute Maximum Ratings<sup>(1)(2)</sup>

ESD Tolerance		2kV <sup>(3)</sup>
		200V <sup>(4)</sup>
V <sub>IN</sub> Differential		±2.5V
Input Current		±10mA
Supply Voltage (V <sup>+</sup> – V <sup>-</sup> )		13.5V
Voltage at Input/Output pins		V <sup>+</sup> +0.8V, V <sup>-</sup> -0.8V
Storage Temperature Range		-65°C to +150°C
Junction Temperature <sup>(5)(6)</sup>		+150°C
Soldering Information	Infrared or Convection (20 sec)	235°C
	Wave Soldering (10 sec)	260°C

- (1) Absolute Maximum Ratings indicate limits beyond which damage to the device may occur. Operating Ratings indicate conditions for which the device is intended to be functional, but specific performance is not ensured. For ensured specifications and the test conditions, see the Electrical Characteristics.
- (2) If Military/Aerospace specified devices are required, please contact the Texas Instruments Sales Office/ Distributors for availability and specifications.
- (3) Human body model, 1.5kΩ in series with 100pF.
- (4) Machine Model, 0Ω in series with 200pF.
- (5) The maximum power dissipation is a function of T<sub>J(MAX)</sub>, θ<sub>JA</sub>, and T<sub>A</sub>. The maximum allowable power dissipation at any ambient temperature is P<sub>D</sub> = (T<sub>J(MAX)</sub> - T<sub>A</sub>) / θ<sub>JA</sub>. All numbers apply for packages soldered directly onto a PC board.
- (6) Applies to both single-supply and split-supply operation. Continuous short circuit operation at elevated ambient temperature can result in exceeding the maximum allowed junction temperature of 150°C.

### Operating Ratings<sup>(1)</sup>

Supply Voltage (V <sup>+</sup> to V <sup>-</sup> )		3V to 12V
Operating Temperature Range <sup>(2)</sup>		-40°C to +85°C
Package Thermal Resistance (θ <sub>JA</sub> ) <sup>(2)</sup>	SOT-23-6	265°C/W
	SOIC-8	190°C/W

- (1) Absolute Maximum Ratings indicate limits beyond which damage to the device may occur. Operating Ratings indicate conditions for which the device is intended to be functional, but specific performance is not ensured. For ensured specifications and the test conditions, see the Electrical Characteristics.
- (2) The maximum power dissipation is a function of T<sub>J(MAX)</sub>, θ<sub>JA</sub>, and T<sub>A</sub>. The maximum allowable power dissipation at any ambient temperature is P<sub>D</sub> = (T<sub>J(MAX)</sub> - T<sub>A</sub>) / θ<sub>JA</sub>. All numbers apply for packages soldered directly onto a PC board.

### 3V Electrical Characteristics

Unless otherwise specified, all limits ensured for at T<sub>J</sub> = 25°C, V<sup>+</sup> = 3V, V<sup>-</sup> = 0V, V<sub>O</sub> = V<sub>CM</sub> = V<sup>+</sup>/2, and R<sub>L</sub> = 2kΩ to V<sup>+</sup>/2.

**Boldface** limits apply at the temperature extremes.

Symbol	Parameter	Conditions	Min <sup>(1)</sup>	Typ <sup>(2)</sup>	Max <sup>(1)</sup>	Units
BW	-3dB BW	A <sub>V</sub> = +1	120	170		MHz
		A <sub>V</sub> = -1		63		
BW <sub>0.1dB</sub>	0.1dB Gain Flatness	R <sub>F</sub> = 2.65kΩ, R <sub>L</sub> = 1kΩ,		16.4		MHz
FPBW	Full Power Bandwidth	A <sub>V</sub> = +1, V <sub>OUT</sub> = 2V <sub>PP</sub> , -1dB V <sup>+</sup> = 1.8V, V <sup>-</sup> = 1.2V		21		MHz
GBW	Gain Bandwidth product	A <sub>V</sub> = +1		83		MHz
e <sub>n</sub>	Input-Referred Voltage Noise	R <sub>F</sub> = 33kΩ	f = 10kHz	19		nV/√Hz
			f = 1MHz	16		
i <sub>n</sub>	Input-Referred Current Noise	R <sub>F</sub> = 1MΩ	f = 10kHz	1.30		pA/√Hz
			f = 1MHz	0.36		
THD	Total Harmonic Distortion	f = 5MHz, V <sub>O</sub> = 2V <sub>PP</sub> , A <sub>V</sub> = +2, R <sub>L</sub> = 1kΩ to V <sup>+</sup> /2		-50		dBc

- (1) All limits are ensured by testing or statistical analysis.
- (2) Typical values represent the most likely parametric norm.

### 3V Electrical Characteristics (continued)

Unless otherwise specified, all limits ensured for at  $T_J = 25^\circ\text{C}$ ,  $V^+ = 3\text{V}$ ,  $V^- = 0\text{V}$ ,  $V_O = V_{\text{CM}} = V^+/2$ , and  $R_L = 2\text{k}\Omega$  to  $V^+/2$ .

**Boldface** limits apply at the temperature extremes.

Symbol	Parameter	Conditions	Min <sup>(1)</sup>	Typ <sup>(2)</sup>	Max <sup>(1)</sup>	Units
$T_S$	Settling Time	$V_O = 2V_{\text{PP}}, \pm 0.1\%$		37		ns
SR	Slew Rate	$A_V = -1$ <sup>(3)</sup>	120	167		V/ $\mu\text{s}$
$V_{\text{OS}}$	Input Offset Voltage			1.01	5 7	mV
TC $V_{\text{OS}}$	Input Offset Average Drift	See <sup>(4)</sup>		8		$\mu\text{V}/^\circ\text{C}$
$I_B$	Input Bias Current	See <sup>(5)</sup>		-1.02	-2.6 -3.5	$\mu\text{A}$
$I_{\text{OS}}$	Input Offset Current			20	800 1000	nA
$R_{\text{IN}}$	Common Mode Input Resistance	$A_V = +1, f = 1\text{kHz}, R_S = 1\text{M}\Omega$		6.1		M $\Omega$
$C_{\text{IN}}$	Common Mode Input Capacitance	$A_V = +1, R_S = 100\text{k}\Omega$		1.35		pF
CMVR	Input Common-Mode Voltage Range	CMRR $\geq 50\text{dB}$		-0.3	-0.2 -0.1	V
			1.8 1.6	2		
CMRR	Common Mode Rejection Ratio	See <sup>(6)</sup>	72	93		dB
$A_{\text{VOL}}$	Large Signal Voltage Gain	$V_O = 2V_{\text{PP}}, R_L = 2\text{k}\Omega$ to $V^+/2$	80 76	100		dB
		$V_O = 2V_{\text{PP}}, R_L = 150\Omega$ to $V^+/2$	74 70	78		
$V_O$	Output Swing High	$R_L = 2\text{k}\Omega$ to $V^+/2, V_{\text{ID}} = 200\text{mV}$	2.90	2.98		V
		$R_L = 150\Omega$ to $V^+/2, V_{\text{ID}} = 200\text{mV}$	2.75	2.93		
		$R_L = 50\Omega$ to $V^+/2, V_{\text{ID}} = 200\text{mV}$	2.6	2.85		
	Output Swing Low	$R_L = 2\text{k}\Omega$ to $V^+/2, V_{\text{ID}} = -200\text{mV}$		25	75	mV
		$R_L = 150\Omega$ to $V^+/2, V_{\text{ID}} = -200\text{mV}$		75	200	
		$R_L = 50\Omega$ to $V^+/2, V_{\text{ID}} = -200\text{mV}$		130	300	
$I_{\text{SC}}$	Output Short Circuit Current	Sourcing to $V^+/2$ <sup>(7)</sup>	50 35	120		mA
		Sinking to $V^+/2$ <sup>(7)</sup>	67 40	140		
$I_{\text{OUT}}$	Output Current	$V_O = 0.5\text{V}$ from either supply		99		mA
PSRR	Power Supply Rejection Ratio	See <sup>(6)</sup>	72	96		dB
$I_S$	Supply Current (Enabled)	No Load		3.5	5.6 7.5	mA
	Supply Current (Disabled)			0.3	0.5 0.7	
TH_SD	Threshold Voltage for Shutdown Mode			$V^+ - 1.59$		V
$I_{\text{SD PIN}}$	Shutdown Pin Input Current	SD Pin Connect to $0\text{V}$ <sup>(8)</sup>		-13		$\mu\text{A}$
$T_{\text{ON}}$	On Time After Shutdown			83		nsec
$T_{\text{OFF}}$	Off Time to Shutdown			160		nsec
$R_{\text{OUT}}$	Output Resistance Closed Loop	$R_F = 10\text{k}\Omega, f = 1\text{kHz}, A_V = -1$		27		m $\Omega$
		$R_F = 10\text{k}\Omega, f = 1\text{MHz}, A_V = -1$		266		

(3) Slew rate is the average of the rising and falling slew rates.

(4) Offset voltage average drift determined by dividing the change in  $V_{\text{OS}}$  at temperature extremes into the total temperature change.

(5) Positive current corresponds to current flowing into the device.

(6)  $f \leq 1\text{kHz}$  (see typical performance Characteristics)

(7) Short circuit test is a momentary test.

(8) Positive current corresponds to current flowing into the device.

## 5V Electrical Characteristics

Unless otherwise specified, all limits ensured for at  $T_J = 25^\circ\text{C}$ ,  $V^+ = 5\text{V}$ ,  $V^- = 0\text{V}$ ,  $V_O = V_{\text{CM}} = V^+/2$ , and  $R_L = 2\text{k}\Omega$  to  $V^+/2$ .

**Boldface** limits apply at the temperature extremes.

Symbol	Parameter	Conditions	Min <sup>(1)</sup>	Typ <sup>(2)</sup>	Max <sup>(1)</sup>	Units
BW	–3dB BW	$A_V = +1$	130	190		MHz
		$A_V = -1$		64		
$BW_{0.1\text{dB}}$	0.1dB Gain Flatness	$R_F = 2.51\text{k}\Omega$ , $R_L = 1\text{k}\Omega$ ,		16.4		MHz
FPBW	Full Power Bandwidth	$A_V = +1$ , $V_{\text{OUT}} = 2V_{\text{PP}}$ , –1dB		28		MHz
GBW	Gain Bandwidth Product	$A_V = +1$		86		MHz
$e_n$	Input-Referred Voltage Noise	$R_F = 33\text{k}\Omega$	$f = 10\text{kHz}$	19		$\text{nV}/\sqrt{\text{Hz}}$
			$f = 1\text{MHz}$	16		
$i_n$	Input-Referred Current Noise	$R_F = 1\text{M}\Omega$	$f = 10\text{kHz}$	1.35		$\text{pA}/\sqrt{\text{Hz}}$
			$f = 1\text{MHz}$	0.35		
THD	Total Harmonic Distortion	$f = 5\text{MHz}$ , $V_O = 2V_{\text{PP}}$ , $A_V = +2$ $R_L = 1\text{k}\Omega$ to $V^+/2$		–60		dBc
DG	Differential Gain	NTSC, $A_V = +2$ $R_L = 150\Omega$ to $V^+/2$		0.12		%
DP	Differential Phase	NTSC, $A_V = +2$ $R_L = 150\Omega$ to $V^+/2$		0.045		deg
$T_S$	Settling Time	$V_O = 2V_{\text{PP}}$ , $\pm 0.1\%$		33		ns
SR	Slew Rate	$A_V = -1$ <sup>(3)</sup>	130	172		$\text{V}/\mu\text{s}$
$V_{\text{OS}}$	Input Offset Voltage			1.02	5 7	mV
TC $V_{\text{OS}}$	Input Offset Average Drift	See <sup>(4)</sup>		8		$\mu\text{V}/^\circ\text{C}$
$I_B$	Input Bias Current	See <sup>(5)</sup>		–1.2	–2.6 –3.25	$\mu\text{A}$
$I_{\text{OS}}$	Input Offset Current			20	800 1000	nA
$R_{\text{IN}}$	Common Mode Input Resistance	$A_V = +1$ , $f = 1\text{kHz}$ , $R_S = 1\text{M}\Omega$		6.88		$\text{M}\Omega$
$C_{\text{IN}}$	Common Mode Input Capacitance	$A_V = +1$ , $R_S = 100\text{k}\Omega$		1.32		pF
CMVR	Common-Mode Input Voltage Range	CMRR $\geq 50\text{dB}$		–0.3	–0.2 –0.1	V
				4	3.8 3.6	
CMRR	Common Mode Rejection Ratio	See <sup>(6)</sup>	72	95		dB
$A_{\text{VOL}}$	Large Signal Voltage Gain	$V_O = 4V_{\text{PP}}$ $R_L = 2\text{k}\Omega$ to $V^+/2$	86 82	100		dB
		$V_O = 3.75V_{\text{PP}}$ $R_L = 150\Omega$ to $V^+/2$	74 70	77		
$V_O$	Output Swing High	$R_L = 2\text{k}\Omega$ to $V^+/2$ , $V_{\text{ID}} = 200\text{mV}$	4.90	4.97		V
		$R_L = 150\Omega$ to $V^+/2$ , $V_{\text{ID}} = 200\text{mV}$	4.65	4.90		
		$R_L = 50\Omega$ to $V^+/2$ , $V_{\text{ID}} = 200\text{mV}$	4.40	4.77		
	Output Swing Low	$R_L = 2\text{k}\Omega$ to $V^+/2$ , $V_{\text{ID}} = -200\text{mV}$		25	100	mV
		$R_L = 150\Omega$ to $V^+/2$ , $V_{\text{ID}} = -200\text{mV}$		85	200	
		$R_L = 50\Omega$ to $V^+/2$ , $V_{\text{ID}} = -200\text{mV}$		190	400	

(1) All limits are ensured by testing or statistical analysis.

(2) Typical values represent the most likely parametric norm.

(3) Slew rate is the average of the rising and falling slew rates.

(4) Offset voltage average drift determined by dividing the change in  $V_{\text{OS}}$  at temperature extremes into the total temperature change.

(5) Positive current corresponds to current flowing into the device.

(6)  $f \leq 1\text{kHz}$  (see typical performance Characteristics)

## 5V Electrical Characteristics (continued)

Unless otherwise specified, all limits ensured for at  $T_J = 25^\circ\text{C}$ ,  $V^+ = 5\text{V}$ ,  $V^- = 0\text{V}$ ,  $V_O = V_{\text{CM}} = V^+/2$ , and  $R_L = 2\text{k}\Omega$  to  $V^+/2$ .

**Boldface** limits apply at the temperature extremes.

Symbol	Parameter	Conditions	Min <sup>(1)</sup>	Typ <sup>(2)</sup>	Max <sup>(1)</sup>	Units
$I_{\text{SC}}$	Output Short Circuit Current	Sourcing to $V^+/2$ <sup>(7)</sup>	100 <b>79</b>	160		mA
		Sinking from $V^+/2$ <sup>(7)</sup>	120 <b>85</b>	190		
$I_{\text{OUT}}$	Output Current	$V_O = 0.5\text{V}$ from either supply		110		mA
PSRR	Power Supply Rejection Ratio	See <sup>(6)</sup>	72	96		dB
$I_S$	Supply Current (Enabled)	No Load		3.6	5.8 <b>8.0</b>	mA
	Supply Current (Disabled)			0.40	0.8 <b>1.0</b>	
TH_SD	Threshold Voltage for Shutdown Mode			$V^+ - 1.65$		V
$I_{\text{SD PIN}}$	Shutdown Pin Input Current	SD Pin Connected to $0\text{V}$ <sup>(5)</sup>		-30		$\mu\text{A}$
$T_{\text{ON}}$	On Time after Shutdown			83		nsec
$T_{\text{OFF}}$	Off Time to Shutdown			160		nsec
$R_{\text{OUT}}$	Output Resistance Closed Loop	$R_F = 10\text{k}\Omega$ , $f = 1\text{kHz}$ , $A_V = -1$		29		m $\Omega$
		$R_F = 10\text{k}\Omega$ , $f = 1\text{MHz}$ , $A_V = -1$		253		

(7) Short circuit test is a momentary test.

## $\pm 5\text{V}$ Electrical Characteristics

Unless otherwise specified, all limits ensured for at  $T_J = 25^\circ\text{C}$ ,  $V_{\text{SUPPLY}} = \pm 5\text{V}$ ,  $V_O = V_{\text{CM}} = \text{GND}$ , and  $R_L = 2\text{k}\Omega$  to  $V^+/2$ .

**Boldface** limits apply at the temperature extremes.

Symbol	Parameter	Conditions	Min <sup>(1)</sup>	Typ <sup>(2)</sup>	Max <sup>(1)</sup>	Units
BW	-3dB BW	$A_V = +1$	150	228		MHz
		$A_V = -1$		65		
$BW_{0.1\text{dB}}$	0.1dB Gain Flatness	$R_F = 2.26\text{k}\Omega$ , $R_L = 1\text{k}\Omega$		18		MHz
FPBW	Full Power Bandwidth	$A_V = +1$ , $V_{\text{OUT}} = 2V_{\text{PP}}$ , -1dB		29		MHz
GBW	Gain Bandwidth Product	$A_V = +1$		90		MHz
$e_n$	Input-Referred Voltage Noise	$R_F = 33\text{k}\Omega$	$f = 10\text{kHz}$	19		$\text{nV}/\sqrt{\text{Hz}}$
			$f = 1\text{MHz}$	16		
$i_n$	Input-Referred Current Noise	$R_F = 1\text{M}\Omega$	$f = 10\text{kHz}$	1.13		$\text{pA}/\sqrt{\text{Hz}}$
			$f = 1\text{MHz}$	0.34		
THD	Total Harmonic Distortion	$f = 5\text{MHz}$ , $V_O = 2V_{\text{PP}}$ , $A_V = +2$ , $R_L = 1\text{k}\Omega$		-71.2		dBc
DG	Differential Gain	NTSC, $A_V = +2$ $R_L = 150\Omega$		0.11		%
DP	Differential Phase	NTSC, $A_V = +2$ $R_L = 150\Omega$		0.053		deg
$T_S$	Settling Time	$V_O = 2V_{\text{PP}}$ , $\pm 0.1\%$		33		ns
SR	Slew Rate	$A_V = -1$ <sup>(3)</sup>	140	200		$\text{V}/\mu\text{s}$
$V_{\text{OS}}$	Input Offset Voltage			1.03	5 <b>7</b>	mV
TC $V_{\text{OS}}$	Input Offset Voltage Drift	See <sup>(4)</sup>		8		$\mu\text{V}/^\circ\text{C}$
$I_B$	Input Bias Current	See <sup>(5)</sup>		-1.40	-2.6 <b>-3.25</b>	$\mu\text{A}$

(1) All limits are ensured by testing or statistical analysis.

(2) Typical values represent the most likely parametric norm.

(3) Slew rate is the average of the rising and falling slew rates.

(4) Offset voltage average drift determined by dividing the change in  $V_{\text{OS}}$  at temperature extremes into the total temperature change.

(5) Positive current corresponds to current flowing into the device.

### ±5V Electrical Characteristics (continued)

Unless otherwise specified, all limits ensured for at  $T_J = 25^\circ\text{C}$ ,  $V_{\text{SUPPLY}} = \pm 5\text{V}$ ,  $V_O = V_{\text{CM}} = \text{GND}$ , and  $R_L = 2\text{k}\Omega$  to  $V^+/2$ .

**Boldface** limits apply at the temperature extremes.

Symbol	Parameter	Conditions	Min <sup>(1)</sup>	Typ <sup>(2)</sup>	Max <sup>(1)</sup>	Units
$I_{\text{OS}}$	Input Offset Current			20	800 <b>1000</b>	nA
$R_{\text{IN}}$	Common Mode Input Resistance	$A_V = +1$ , $f = 1\text{kHz}$ , $R_S = 1\text{M}\Omega$		7.5		$\text{M}\Omega$
$C_{\text{IN}}$	Common Mode Input Capacitance	$A_V = +1$ , $R_S = 100\text{k}\Omega$		1.28		pF
CMVR	Common Mode Input Voltage Range	CMRR $\geq 50\text{dB}$		-5.3	-5.2 <b>-5.1</b>	V
			<b>3.8</b> <b>3.6</b>	4.0		
CMRR	Common Mode Rejection Ratio	See <sup>(6)</sup>	72	95		dB
$A_{\text{VOL}}$	Large Signal Voltage Gain	$V_O = 9V_{\text{PP}}$ , $R_L = 2\text{k}\Omega$	<b>88</b> <b>84</b>	100		dB
		$V_O = 8V_{\text{PP}}$ , $R_L = 150\Omega$	74 <b>70</b>	77		
$V_O$	Output Swing High	$R_L = 2\text{k}\Omega$ , $V_{\text{ID}} = 200\text{mV}$	4.85	4.96		V
		$R_L = 150\Omega$ , $V_{\text{ID}} = 200\text{mV}$	4.55	4.80		
		$R_L = 50\Omega$ , $V_{\text{ID}} = 200\text{mV}$	3.60	4.55		
	Output Swing Low	$R_L = 2\text{k}\Omega$ , $V_{\text{ID}} = -200\text{mV}$		-4.97	-4.90	V
		$R_L = 150\Omega$ , $V_{\text{ID}} = -200\text{mV}$		-4.85	-4.55	
		$R_L = 50\Omega$ , $V_{\text{ID}} = -200\text{mV}$		-4.65	-4.30	
$I_{\text{SC}}$	Output Short Circuit Current	Sourcing to Ground <sup>(7)</sup>	100 <b>80</b>	168		mA
		Sinking to Ground <sup>(7)</sup>	110 <b>85</b>	190		
$I_{\text{OUT}}$	Output Current	$V_O = 0.5\text{V}$ from either supply		112		mA
PSRR	Power Supply Rejection Ratio	See <sup>(8)</sup>	72	96		dB
$I_S$	Supply Current (Enabled)	No Load		4.18	6.5 <b>8.5</b>	mA
	Supply Current (Disabled)			0.758	1.0 <b>1.3</b>	
TH_SD	Threshold Voltage for Shutdown Mode			$V^+ - 1.67$		V
$I_{\text{SD PIN}}$	Shutdown Pin Input Current	SD Pin Connected to $-5\text{V}$ <sup>(9)</sup>		-84		$\mu\text{A}$
$T_{\text{ON}}$	On Time after Shutdown			83		nsec
$T_{\text{OFF}}$	Off Time to Shutdown			160		nsec
$R_{\text{OUT}}$	Output Resistance Closed Loop	$R_F = 10\text{k}\Omega$ , $f = 1\text{kHz}$ , $A_V = -1$		32		$\text{m}\Omega$
		$R_F = 10\text{k}\Omega$ , $f = 1\text{MHz}$ , $A_V = -1$		226		

(6)  $f \leq 1\text{kHz}$  (see typical performance Characteristics)

(7) Short circuit test is a momentary test.

(8)  $f \leq 1\text{kHz}$  (see typical performance Characteristics)

(9) Positive current corresponds to current flowing into the device.

**Connection Diagram**

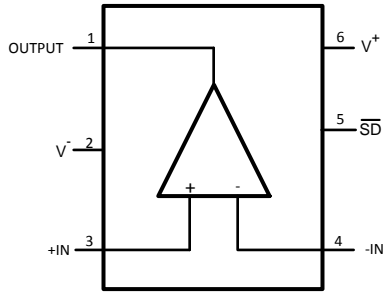

**Figure 2. SOT-23-6  
Top View**

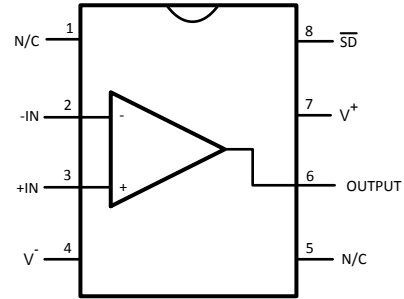

**Figure 3. SOIC-8  
Top View**

### Typical Performance Characteristics

At  $T_J = 25^\circ\text{C}$ ,  $V^+ = +2.5$ ,  $V^- = -2.5\text{V}$ ,  $R_F = 330\Omega$  for  $A_V = +2$ ,  $R_F = 1\text{k}\Omega$  for  $A_V = -1$ . Unless otherwise specified.

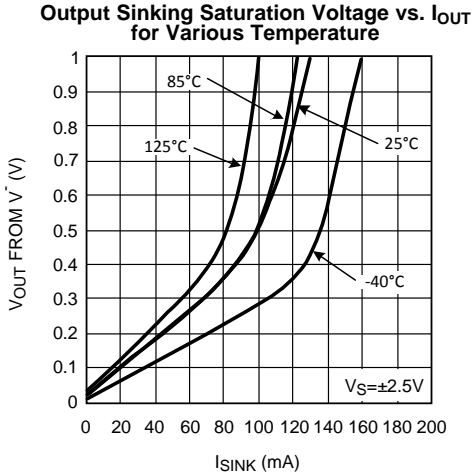

Figure 4.

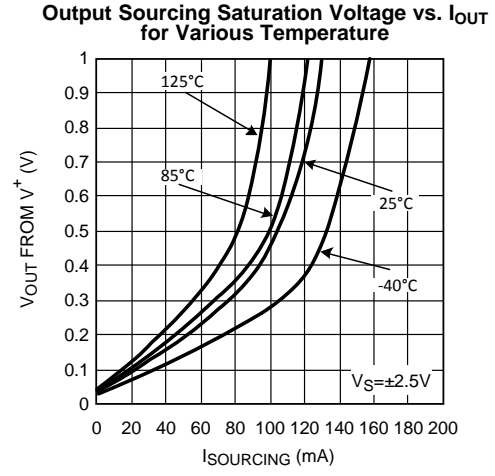

Figure 5.

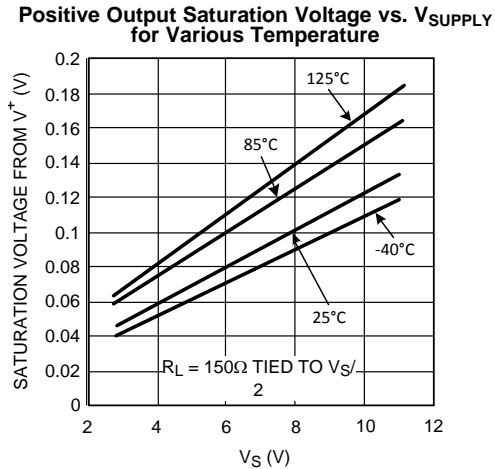

Figure 6.

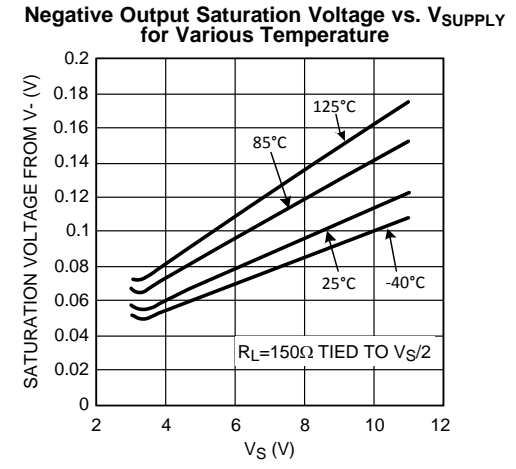

Figure 7.

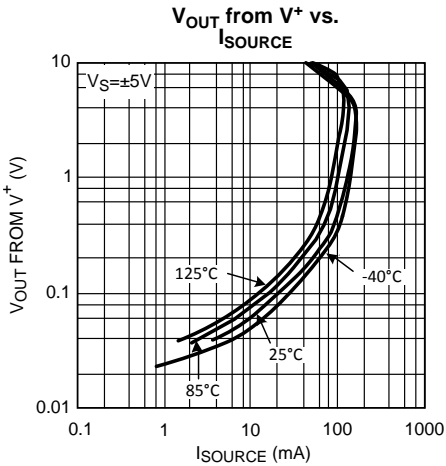

Figure 8.

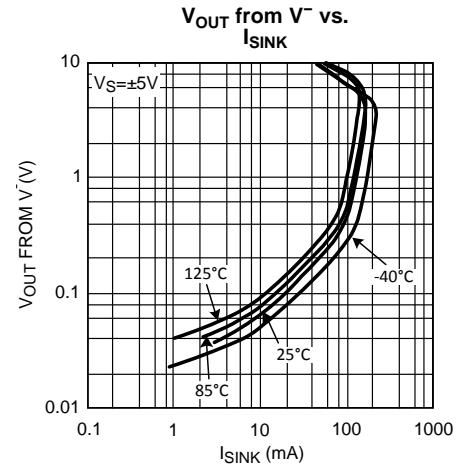

Figure 9.



**Typical Performance Characteristics (continued)**

At  $T_J = 25^\circ\text{C}$ ,  $V^+ = +2.5$ ,  $V^- = -2.5$ ,  $R_F = 330\Omega$  for  $A_V = +2$ ,  $R_F = 1\text{k}\Omega$  for  $A_V = -1$ . Unless otherwise specified.

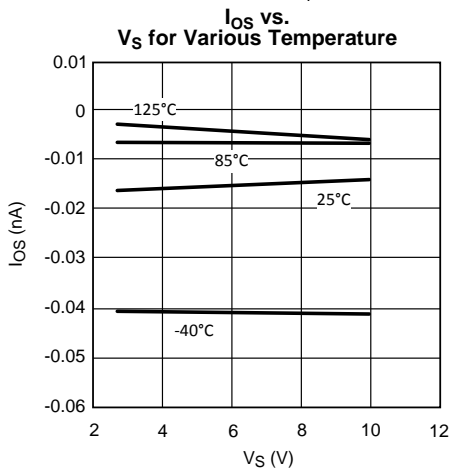

Figure 10.

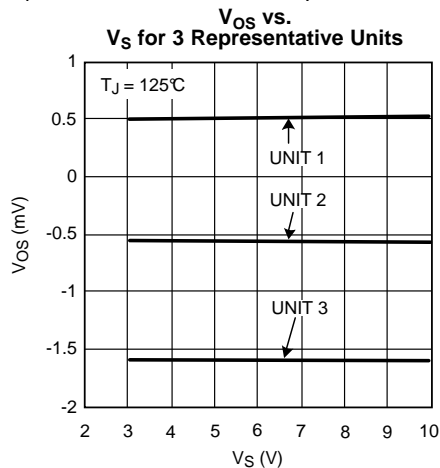

Figure 11.

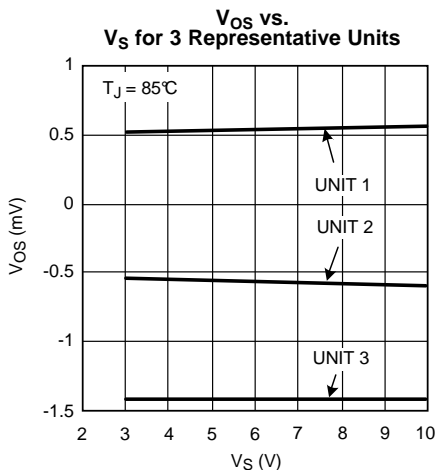

Figure 12.

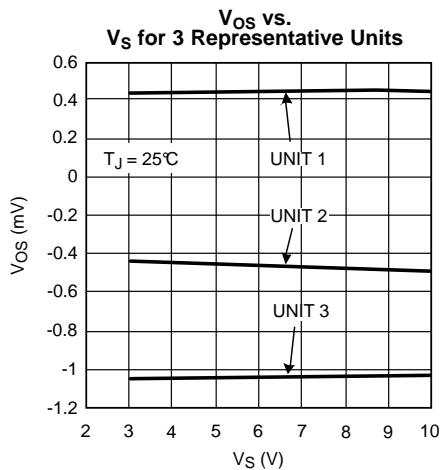

Figure 13.

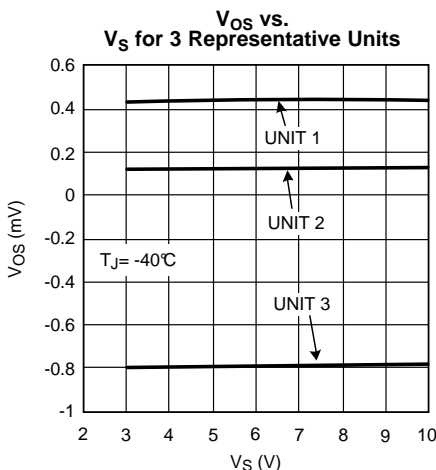

Figure 14.

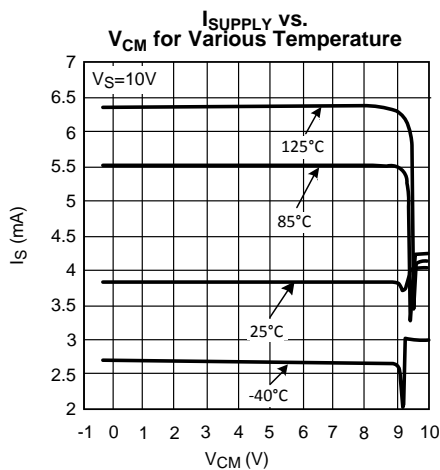

Figure 15.

**Typical Performance Characteristics (continued)**

At  $T_J = 25^\circ\text{C}$ ,  $V^+ = +2.5$ ,  $V^- = -2.5$ ,  $R_F = 330\Omega$  for  $A_V = +2$ ,  $R_F = 1\text{k}\Omega$  for  $A_V = -1$ . Unless otherwise specified.

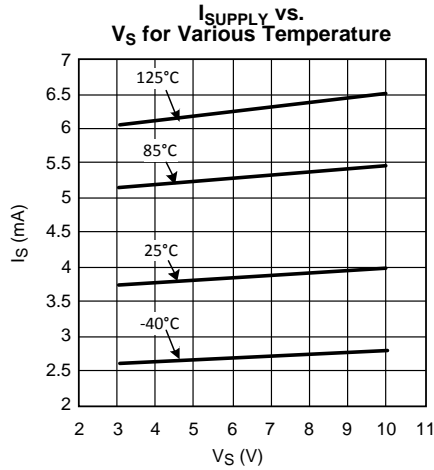

Figure 16.

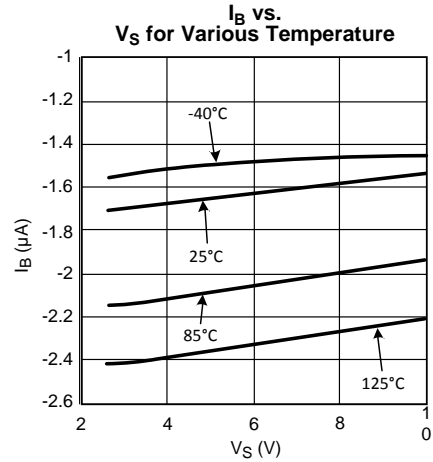

Figure 17.

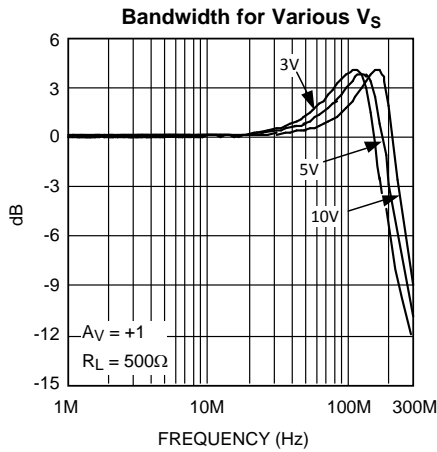

Figure 18.

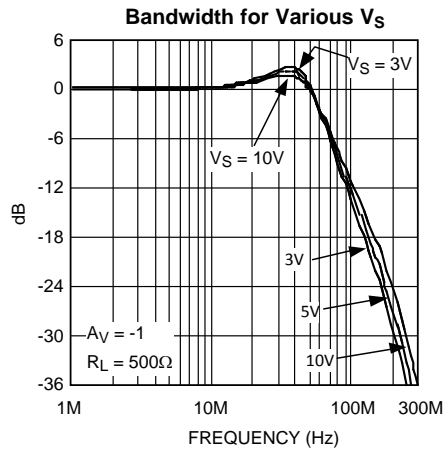

Figure 19.

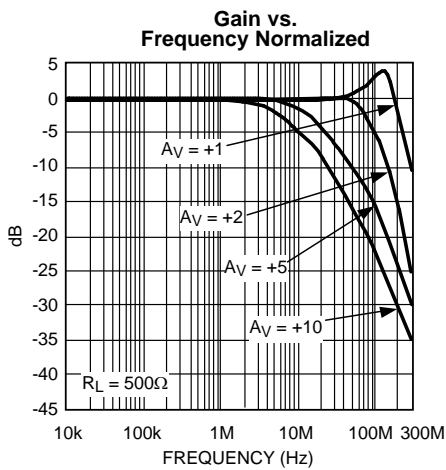

Figure 20.

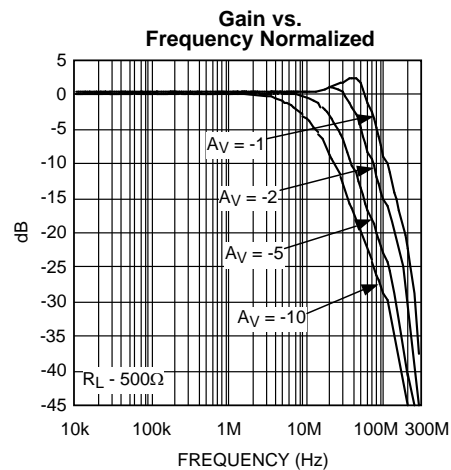

Figure 21.

Typical Performance Characteristics (continued)

At  $T_J = 25^\circ\text{C}$ ,  $V^+ = +2.5$ ,  $V^- = -2.5$ ,  $R_F = 330\Omega$  for  $A_V = +2$ ,  $R_F = 1\text{k}\Omega$  for  $A_V = -1$ . Unless otherwise specified.

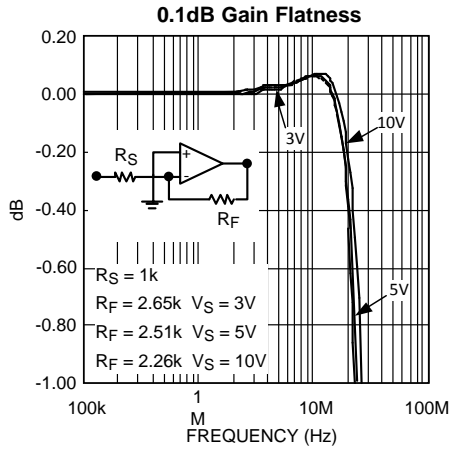

Figure 22.

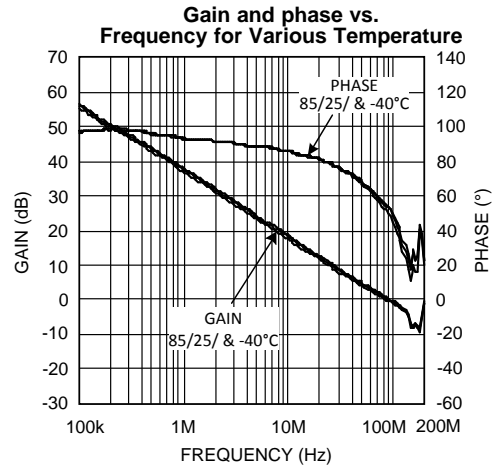

Figure 23.

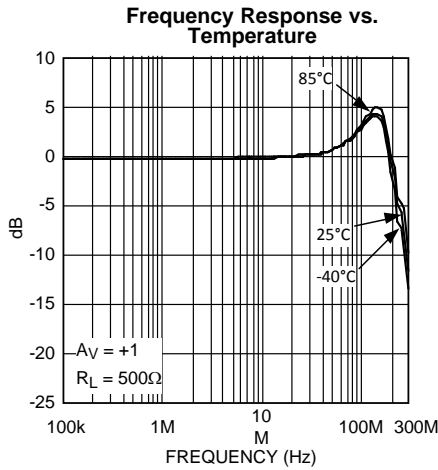

Figure 24.

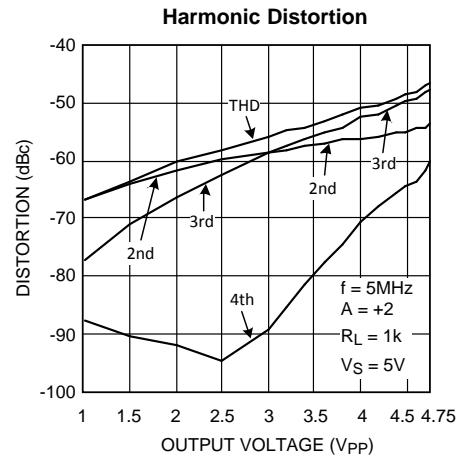

Figure 25.

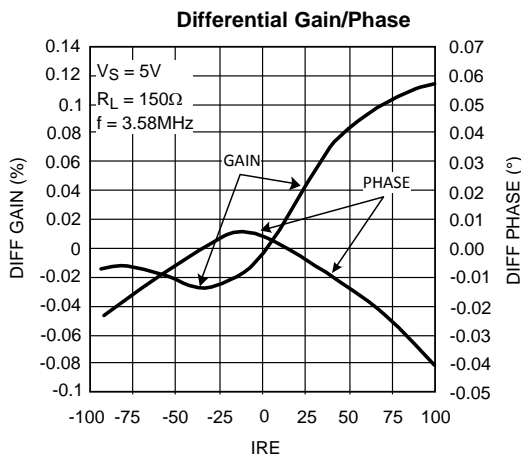

Figure 26.

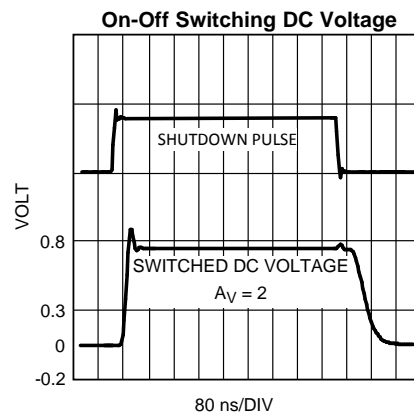

Figure 27.

**Typical Performance Characteristics (continued)**

At  $T_J = 25^\circ\text{C}$ ,  $V^+ = +2.5\text{V}$ ,  $V^- = -2.5\text{V}$ ,  $R_F = 330\Omega$  for  $A_V = +2$ ,  $R_F = 1\text{k}\Omega$  for  $A_V = -1$ . Unless otherwise specified.

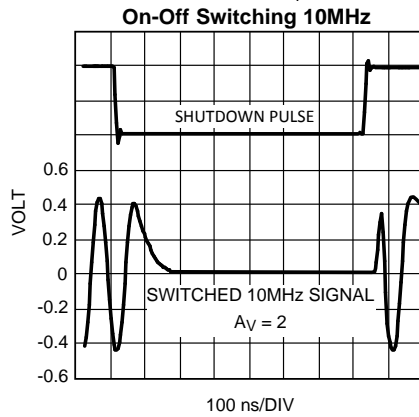

Figure 28.

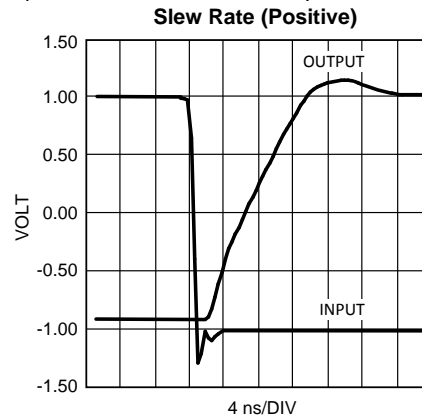

Figure 29.

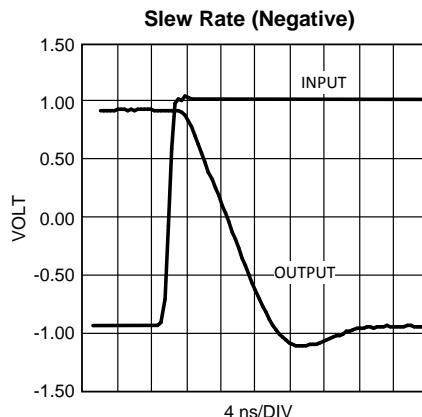

Figure 30.

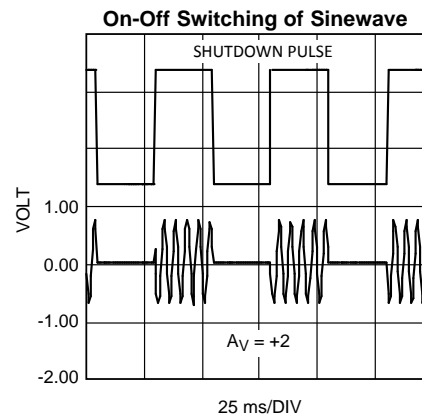

Figure 31.

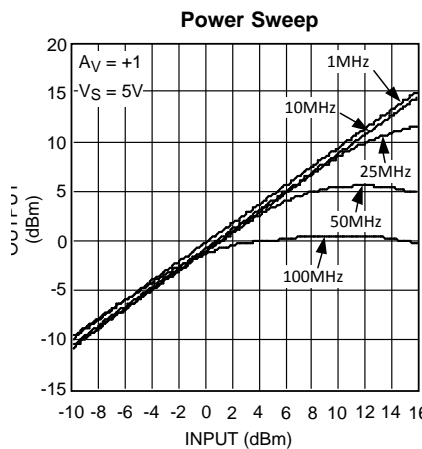

Figure 32.

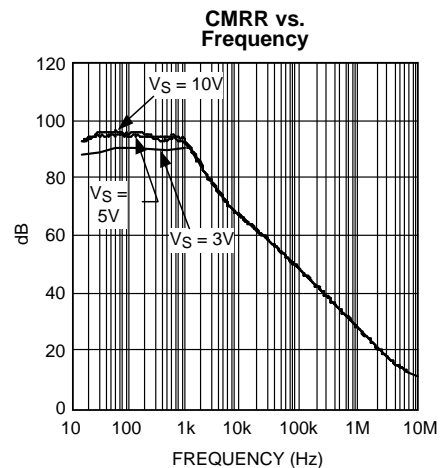

Figure 33.

**Typical Performance Characteristics (continued)**

At  $T_J = 25^\circ\text{C}$ ,  $V^+ = +2.5$ ,  $V^- = -2.5$ ,  $R_F = 330\Omega$  for  $A_V = +2$ ,  $R_F = 1\text{k}\Omega$  for  $A_V = -1$ . Unless otherwise specified.

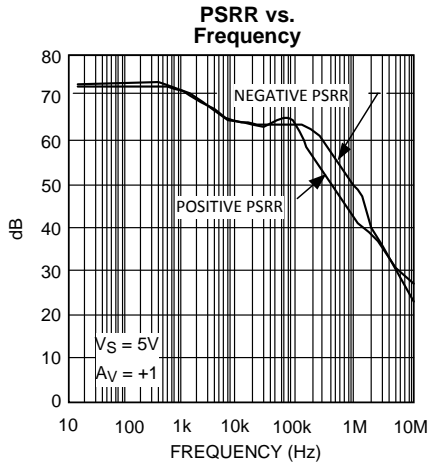

Figure 34.

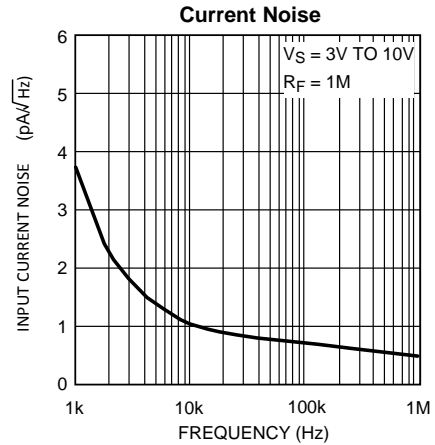

Figure 35.

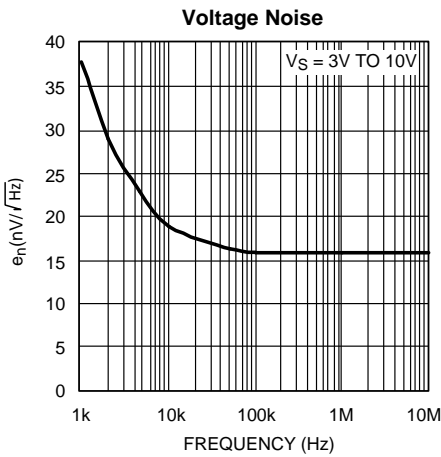

Figure 36.

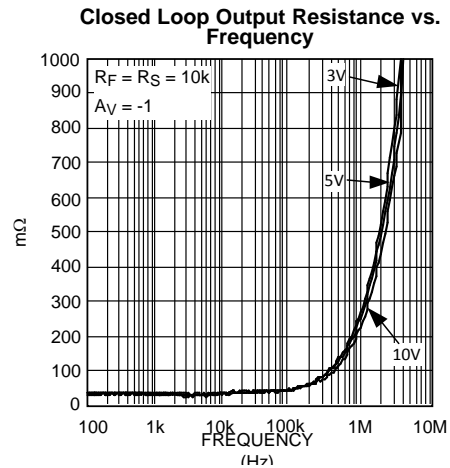

Figure 37.

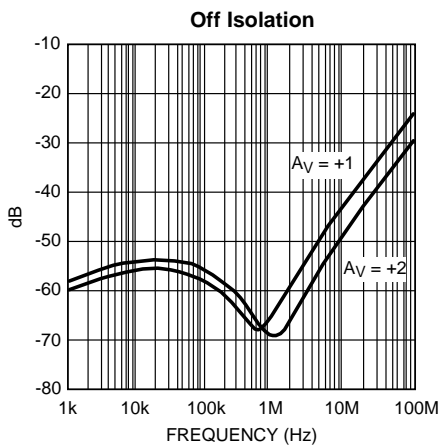

Figure 38.

**Small Signal Pulse Response ( $A_V = +1$ ,  $R_L = 2\text{k}$ )**

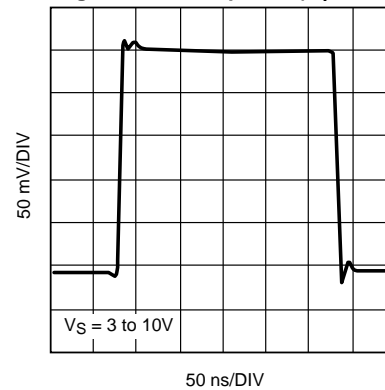
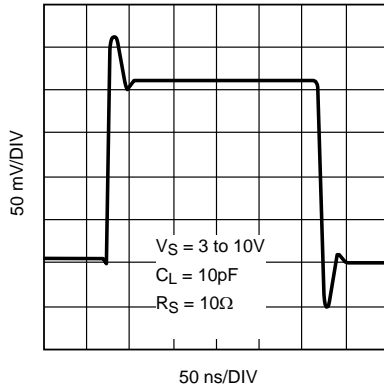

Figure 39.

**Typical Performance Characteristics (continued)**

At  $T_J = 25^\circ\text{C}$ ,  $V^+ = +2.5$ ,  $V^- = -2.5\text{V}$ ,  $R_F = 330\Omega$  for  $A_V = +2$ ,  $R_F = 1\text{k}\Omega$  for  $A_V = -1$ . Unless otherwise specified.

**Small Signal Pulse Response ( $A_V = -1$ )**



**Figure 40.**

**Large Signal Pulse Response ( $R_L = 2\text{k}$ )**

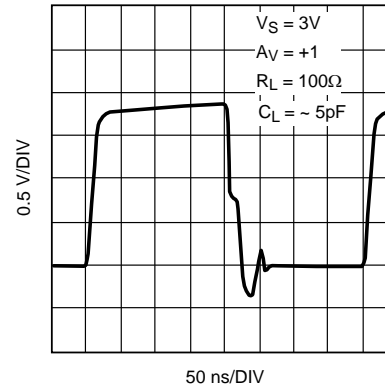

**Figure 41.**

**Large Signal Pulse Response**

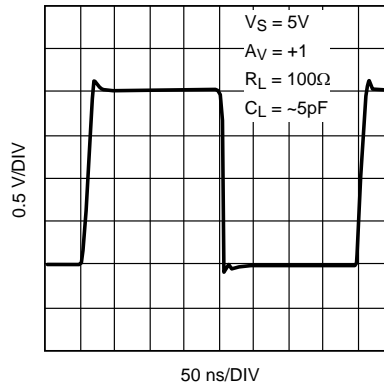

**Figure 42.**

**Large Signal Pulse Response**

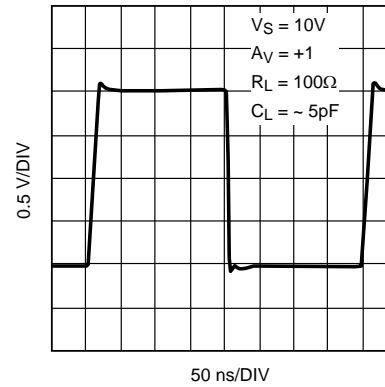

**Figure 43.**

## APPLICATION NOTES

### INPUT AND OUTPUT TOPOLOGY

All input / output pins are protected against excessive voltages by ESD diodes connected to V+ and V- rails (see Figure 44). These diodes start conducting when the input / output pin voltage approaches  $1V_{be}$  beyond V+ or V- to protect against over voltage. These diodes are normally reverse biased. Further protection of the inputs is provided by the two resistors (R in Figure 44), in conjunction with the string of anti-parallel diodes connected between both bases of the input stage. The combination of these resistors and diodes reduces excessive differential input voltages approaching  $2V_{be}$ . The most common situation when this occurs is when the device is put in shutdown and the LMH6639's inputs no longer follow each other. In such a case, the diodes may conduct. As a consequence, input current increases, and a portion of signal may appear at the Hi-Z output. Another possible situation for the conduction of these diodes is when the LMH6639 is used as a comparator (or with little or no feedback). In either case, it is important to make sure that the subsequent current flow through the device input pins does not violate the [Absolute Maximum Ratings](#) of the device. To limit the current through the protection circuit extra series resistors can be placed. Together with the build in series resistors of several hundred ohms this extra resistors can limit the input current to a safe number depending on the used application. Be aware of the effect that extra series resistors may impact the switching speed of the device. A special situation occurs when the part is configured for a gain of +1, which means the output is directly connected to the inverting input, see Figure 45. When the part is now placed in shutdown mode the output comes in a high impedance state and is unable to keep the inverting input at the same level as the non-inverting input. In many applications the output is connected to the ground via a low impedance resistor. When this situation occurs and there is a DC voltage offset of more than 2 volt between the non-inverting input and the output, current flows from the non-inverting input through the series resistors R via the bypass diodes to the output. Now the input current becomes much bigger than expected and in many cases the source at the input cannot deliver this current and will drop down. Be sure in this situation that no DC current path is available from the non-inverting input to the output pin, or from the output pin to the load resistor. This DC path is drawn by a curved line and can be broken by placing one of the capacitors  $C_{IN}$  or  $C_{OUT}$  or both, depending on the used application.

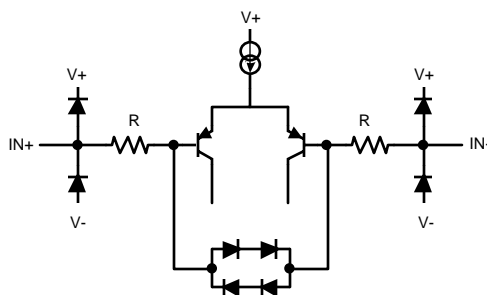

Figure 44.

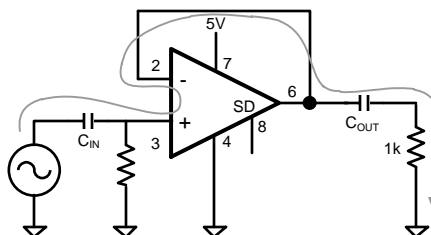
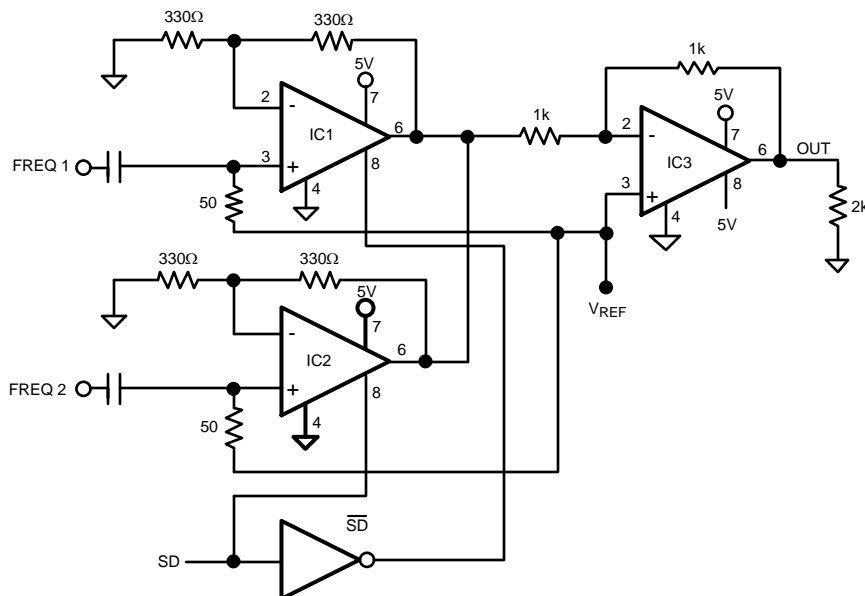

Figure 45. DC path while in shutdown

## MULTIPLEXING 5 AND 10MHz

The LMH6639 may be used to implement a circuit which multiplexes two signals of different frequencies. Three LMH6639 high speed op-amps are used in the circuit of [Figure 46](#) to accomplish the multiplexing function. Two LMH6639 are used to provide gain for the input signals, and the third device is used to provide output gain for the selected signal.



Note: Pin numbers pertain to SOIC-8 package

**Figure 46. Multiplexer**

Multiplexing signals “FREQ 1” and “FREQ 2” exhibit closed loop non-inverting gain of +2 each based upon identical 330Ω resistors in the gain setting positions of IC1 and IC2. The two multiplexing signals are combined at the input of IC3, which is the third LMH6639. This amplifier may be used as a unity gain buffer or may be used to set a particular gain for the circuit.

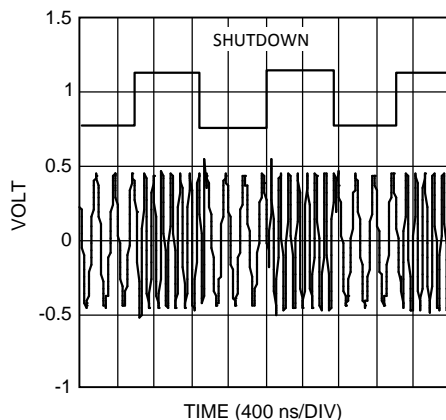

**Figure 47. Switching between 5 and 10MHz**

1k resistors are used to set an inverting gain of  $-1$  for IC3 in the circuit of [Figure 46](#). [Figure 47](#) illustrates the waveforms produced. The upper trace shows the switching waveform used to switch between the 5MHz and 10MHz multiplex signals. The lower trace shows the output waveform consisting of 5MHz and 10MHz signals corresponding to the high or low state of the switching signal.



In the circuit of [Figure 46](#), the outputs of IC1 and IC2 are tied together such that their output impedances are placed in parallel at the input of IC3. The output impedance of the disabled amplifier is high compared both to the output impedance of the active amplifier and the 330Ω gain setting resistors. The closed loop output resistance for the LMH6639 is around 0.2Ω. Thus the active state amplifier output impedance dominates the input node to IC3, while the disabled amplifier is assured of a high level of suppression of unwanted signals which might be present at the output.

## SHUTDOWN OPERATION

With  $\overline{SD}$  pin left floating, the device enters normal operation. However, since the  $\overline{SD}$  pin has high input impedance, it is best tied to  $V^+$  for normal operation. This will avoid inadvertent shutdown due to capacitive pick-up from nearby nodes. LMH6639 will typically go into shutdown when  $\overline{SD}$  pin is more than 1.7V below  $V^+$ , regardless of operating supplies.

The  $\overline{SD}$  pin can be driven by push-pull or open collector (open drain) output logic. Because the LMH6639's shutdown is referenced to  $V^+$ , interfacing to the shutdown logic is rather simple, for both single and dual supply operation, with either form of logic used. Typical configurations are shown in [Figure 48](#) and [Figure 49](#) below for push-pull output:

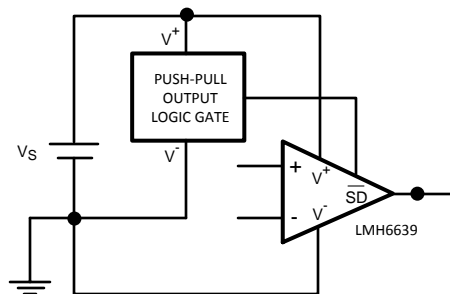

Figure 48. Shutdown Interface (Single Supply)

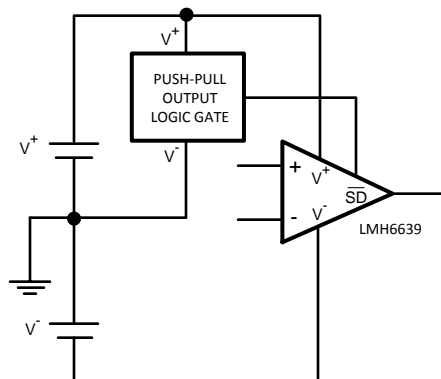
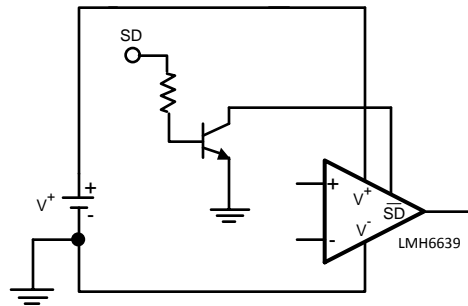

Figure 49. Shutdown Interface (Dual Supplies)

Common voltages for logic gates are +5V or +3V. To ensure proper power on/off with these supplies, the logic should be able to swing to 3.4V and 1.4V minimum, respectively.

LMH6639's shutdown pin can also be easily controlled in applications where the analog and digital sections are operated at different supplies. [Figure 50](#) shows a configuration where a logic output, SD, can turn the LMH6639 on and off, independent of what supplies are used for the analog and the digital sections:



**Figure 50. Shutdown Interface (Single Supply, Open Collector Logic)**

The LMH6639 has an internal pull-up resistor on  $\overline{SD}$  such that if left un-connected, the device will be in normal operation. Therefore, no pull-up resistor is needed on this pin. Another common application is where the transistor in [Figure 50](#) above, would be internal to an open collector (open drain) logic gate; the basic connections will remain the same as shown.

### PCB LAYOUT CONSIDERATION AND COMPONENTS SELECTION

Care should be taken while placing components on a PCB. All standard rules should be followed especially the ones for high frequency and/ or high gain designs. Input and output pins should be separated to reduce cross-talk, especially under high gain conditions. A groundplane will be helpful to avoid oscillations. In addition, a ground plane can be used to create micro-strip transmission lines for matching purposes. Power supply, as well as shutdown pin de-coupling will reduce cross-talk and chances of oscillations.

Another important parameter in working with high speed amplifiers is the component values selection. Choosing high value resistances reduces the cut-off frequency because of the influence of parasitic capacitances. On the other hand choosing the resistor values too low could "load down" the nodes and will contribute to higher overall power dissipation. Keeping resistor values at several hundreds of ohms up to several k $\Omega$  will offer good performance.

Texas Instruments suggests the following evaluation boards as a guide for high frequency layout and as an aid in device testing and characterization:

Device	Package	Evaluation Board PN
LMH6639MA	8-Pin SOIC	CLC730027
LMH6639MF	SOT-23-6	CLC730116

---

**REVISION HISTORY****Changes from Revision F (March 2013) to Revision G****Page**

---

## PACKAGING INFORMATION

Orderable Device	Status (1)	Package Type	Package Drawing	Pins	Package Qty	Eco Plan (2)	Lead finish/ Ball material (6)	MSL Peak Temp (3)	Op Temp (°C)	Device Marking (4/5)	Samples
LMH6639 MDC	ACTIVE	DIESALE	Y	0	400	RoHS & Green	Call TI	Level-1-NA-UNLIM	-40 to 85		<a href="#">Samples</a>
LMH6639MA	NRND	SOIC	D	8	95	Non-RoHS & Green	Call TI	Level-1-235C-UNLIM	-40 to 85	LMH6639MA	
LMH6639MA/NOPB	ACTIVE	SOIC	D	8	95	RoHS & Green	SN	Level-1-260C-UNLIM	-40 to 85	LMH6639MA	<a href="#">Samples</a>
LMH6639MAX/NOPB	ACTIVE	SOIC	D	8	2500	RoHS & Green	SN	Level-1-260C-UNLIM	-40 to 85	LMH6639MA	<a href="#">Samples</a>
LMH6639MF	NRND	SOT-23	DBV	6	1000	Non-RoHS & Green	Call TI	Level-1-260C-UNLIM	-40 to 85	A81A	
LMH6639MF/NOPB	ACTIVE	SOT-23	DBV	6	1000	RoHS & Green	SN	Level-1-260C-UNLIM	-40 to 85	A81A	<a href="#">Samples</a>
LMH6639MFX/NOPB	ACTIVE	SOT-23	DBV	6	3000	RoHS & Green	SN	Level-1-260C-UNLIM	-40 to 85	A81A	<a href="#">Samples</a>

(1) The marketing status values are defined as follows:

**ACTIVE:** Product device recommended for new designs.

**LIFEBUY:** TI has announced that the device will be discontinued, and a lifetime-buy period is in effect.

**NRND:** Not recommended for new designs. Device is in production to support existing customers, but TI does not recommend using this part in a new design.

**PREVIEW:** Device has been announced but is not in production. Samples may or may not be available.

**OBSOLETE:** TI has discontinued the production of the device.

(2) **RoHS:** TI defines "RoHS" to mean semiconductor products that are compliant with the current EU RoHS requirements for all 10 RoHS substances, including the requirement that RoHS substance do not exceed 0.1% by weight in homogeneous materials. Where designed to be soldered at high temperatures, "RoHS" products are suitable for use in specified lead-free processes. TI may reference these types of products as "Pb-Free".

**RoHS Exempt:** TI defines "RoHS Exempt" to mean products that contain lead but are compliant with EU RoHS pursuant to a specific EU RoHS exemption.

**Green:** TI defines "Green" to mean the content of Chlorine (Cl) and Bromine (Br) based flame retardants meet JS709B low halogen requirements of <=1000ppm threshold. Antimony trioxide based flame retardants must also meet the <=1000ppm threshold requirement.

(3) MSL, Peak Temp. - The Moisture Sensitivity Level rating according to the JEDEC industry standard classifications, and peak solder temperature.

(4) There may be additional marking, which relates to the logo, the lot trace code information, or the environmental category on the device.

(5) Multiple Device Markings will be inside parentheses. Only one Device Marking contained in parentheses and separated by a "~" will appear on a device. If a line is indented then it is a continuation of the previous line and the two combined represent the entire Device Marking for that device.

<sup>(6)</sup> Lead finish/Ball material - Orderable Devices may have multiple material finish options. Finish options are separated by a vertical ruled line. Lead finish/Ball material values may wrap to two lines if the finish value exceeds the maximum column width.

**Important Information and Disclaimer:**The information provided on this page represents TI's knowledge and belief as of the date that it is provided. TI bases its knowledge and belief on information provided by third parties, and makes no representation or warranty as to the accuracy of such information. Efforts are underway to better integrate information from third parties. TI has taken and continues to take reasonable steps to provide representative and accurate information but may not have conducted destructive testing or chemical analysis on incoming materials and chemicals. TI and TI suppliers consider certain information to be proprietary, and thus CAS numbers and other limited information may not be available for release.

In no event shall TI's liability arising out of such information exceed the total purchase price of the TI part(s) at issue in this document sold by TI to Customer on an annual basis.

**TAPE AND REEL INFORMATION**

**QUADRANT ASSIGNMENTS FOR PIN 1 ORIENTATION IN TAPE**



\*All dimensions are nominal

Device	Package Type	Package Drawing	Pins	SPQ	Reel Diameter (mm)	Reel Width W1 (mm)	A0 (mm)	B0 (mm)	K0 (mm)	P1 (mm)	W (mm)	Pin1 Quadrant
LMH6639MAX/NOPB	SOIC	D	8	2500	330.0	12.4	6.5	5.4	2.0	8.0	12.0	Q1
LMH6639MF	SOT-23	DBV	6	1000	178.0	8.4	3.2	3.2	1.4	4.0	8.0	Q3
LMH6639MF/NOPB	SOT-23	DBV	6	1000	178.0	8.4	3.2	3.2	1.4	4.0	8.0	Q3
LMH6639MFX/NOPB	SOT-23	DBV	6	3000	178.0	8.4	3.2	3.2	1.4	4.0	8.0	Q3

**TAPE AND REEL BOX DIMENSIONS**

\*All dimensions are nominal

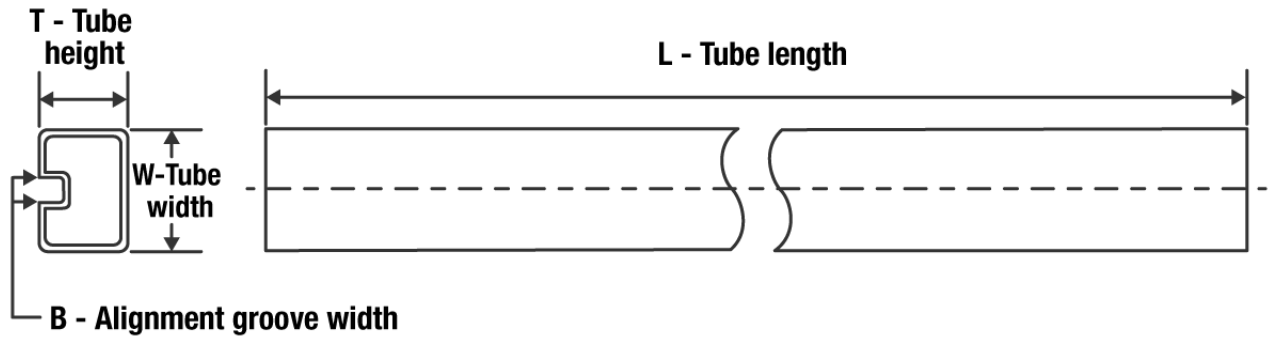
Device	Package Type	Package Drawing	Pins	SPQ	Length (mm)	Width (mm)	Height (mm)
LMH6639MAX/NOPB	SOIC	D	8	2500	367.0	367.0	35.0
LMH6639MF	SOT-23	DBV	6	1000	208.0	191.0	35.0
LMH6639MF/NOPB	SOT-23	DBV	6	1000	208.0	191.0	35.0
LMH6639MFX/NOPB	SOT-23	DBV	6	3000	208.0	191.0	35.0

**TUBE**

\*All dimensions are nominal

Device	Package Name	Package Type	Pins	SPQ	L (mm)	W (mm)	T (μm)	B (mm)
LMH6639MA	D	SOIC	8	95	495	8	4064	3.05
LMH6639MA	D	SOIC	8	95	495	8	4064	3.05
LMH6639MA/NOPB	D	SOIC	8	95	495	8	4064	3.05





# DBV0006A

# PACKAGE OUTLINE

SOT-23 - 1.45 mm max height

SMALL OUTLINE TRANSISTOR

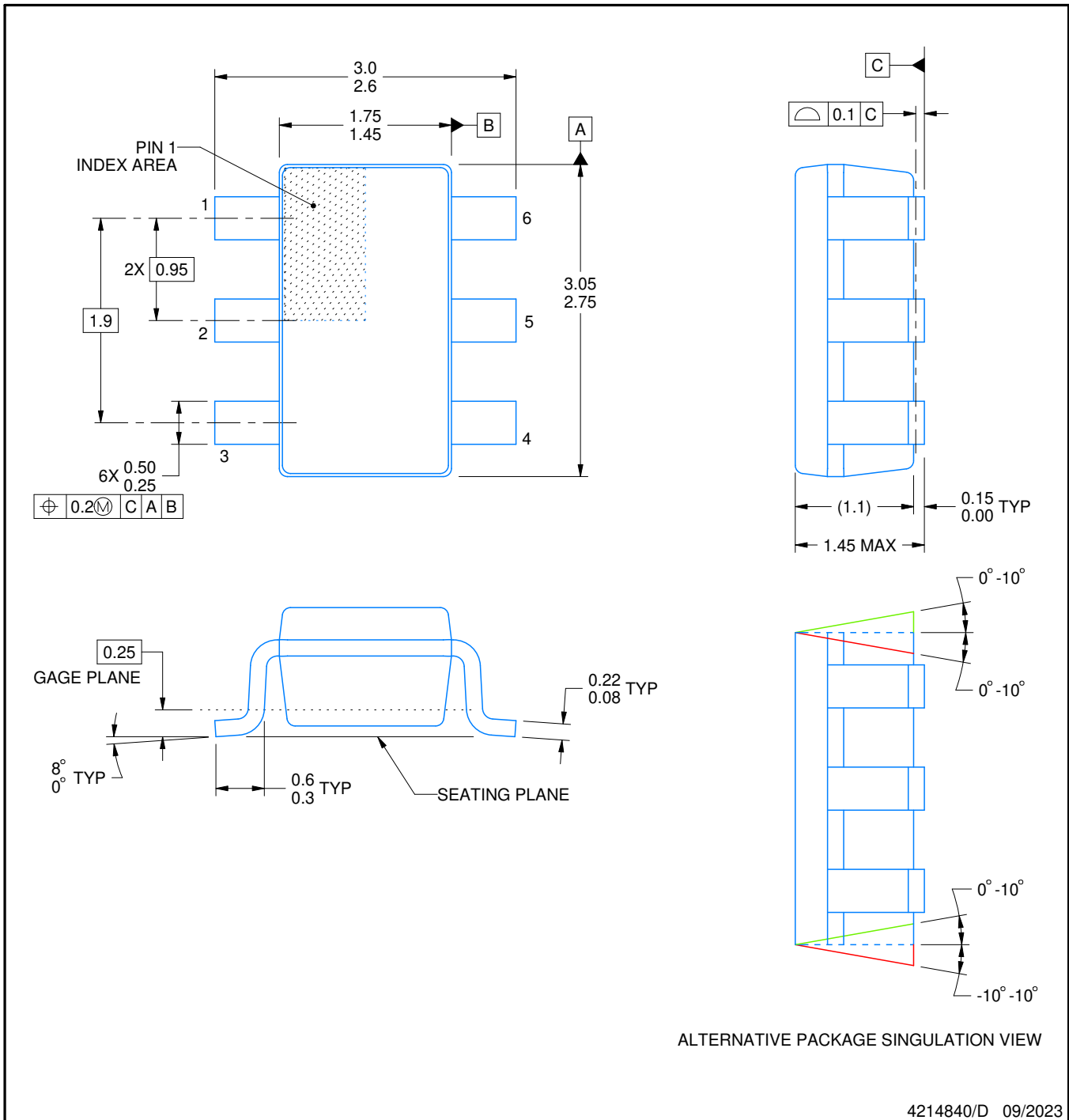

## NOTES:

1. All linear dimensions are in millimeters. Any dimensions in parenthesis are for reference only. Dimensioning and tolerancing per ASME Y14.5M.
2. This drawing is subject to change without notice.
3. Body dimensions do not include mold flash or protrusion. Mold flash and protrusion shall not exceed 0.25 per side.
4. Leads 1,2,3 may be wider than leads 4,5,6 for package orientation.
5. Reference JEDEC MO-178.

# EXAMPLE BOARD LAYOUT

DBV0006A

SOT-23 - 1.45 mm max height

SMALL OUTLINE TRANSISTOR

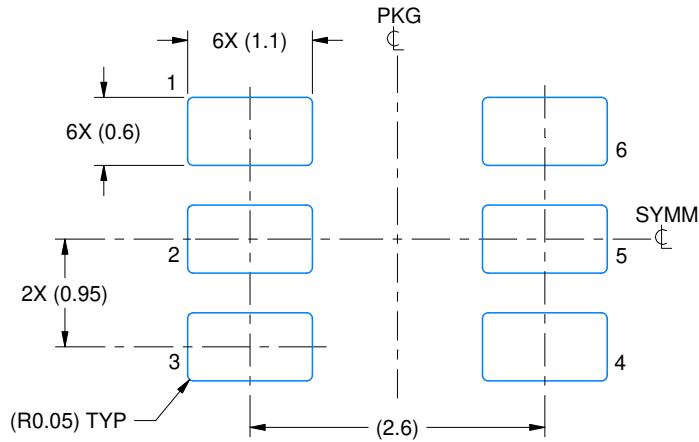

LAND PATTERN EXAMPLE  
EXPOSED METAL SHOWN  
SCALE:15X

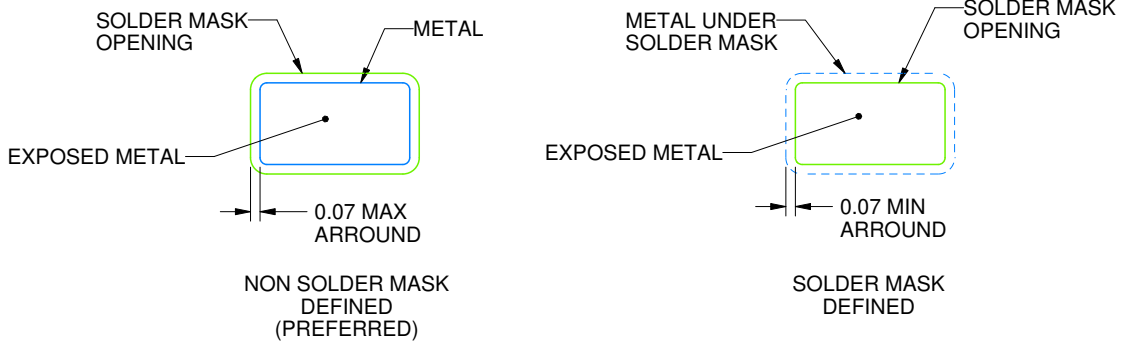

SOLDER MASK DETAILS

4214840/D 09/2023

NOTES: (continued)

6. Publication IPC-7351 may have alternate designs.

7. Solder mask tolerances between and around signal pads can vary based on board fabrication site.

# EXAMPLE STENCIL DESIGN

DBV0006A

SOT-23 - 1.45 mm max height

SMALL OUTLINE TRANSISTOR

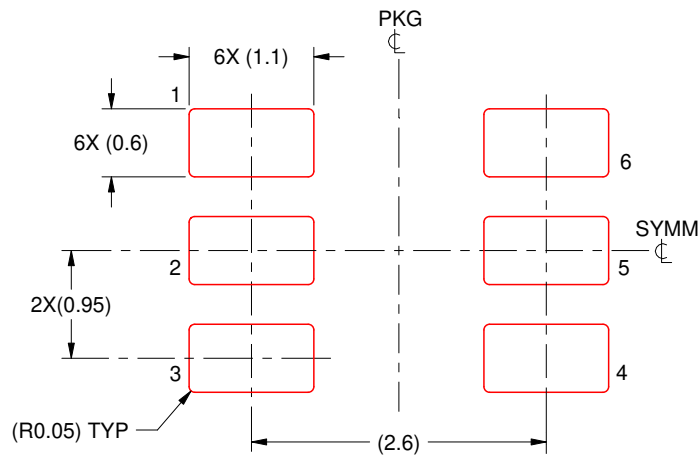

SOLDER PASTE EXAMPLE  
BASED ON 0.125 mm THICK STENCIL  
SCALE:15X

4214840/D 09/2023

NOTES: (continued)

8. Laser cutting apertures with trapezoidal walls and rounded corners may offer better paste release. IPC-7525 may have alternate design recommendations.
9. Board assembly site may have different recommendations for stencil design.

# D0008A



## PACKAGE OUTLINE

SOIC - 1.75 mm max height

SMALL OUTLINE INTEGRATED CIRCUIT

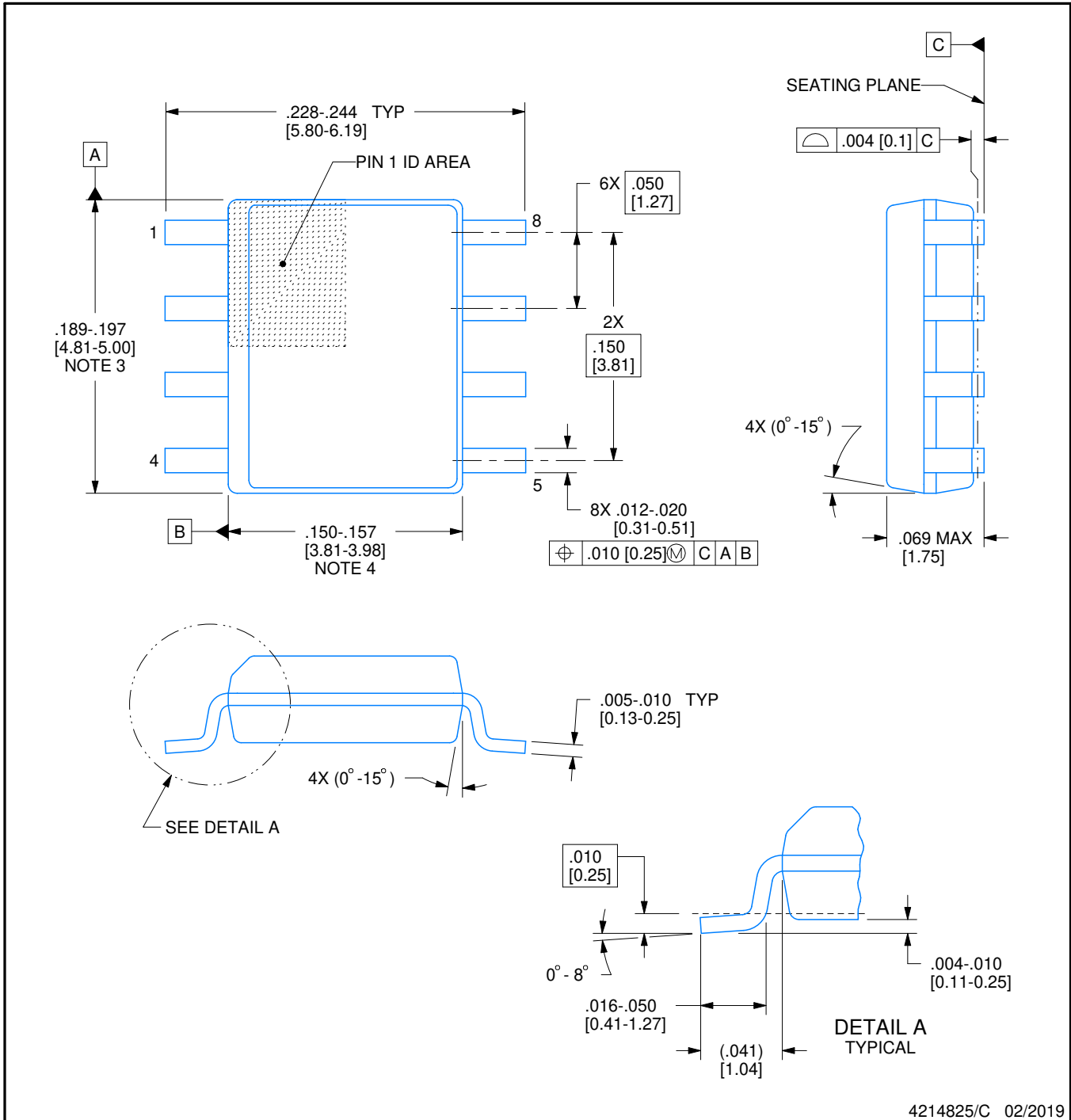

### NOTES:

1. Linear dimensions are in inches [millimeters]. Dimensions in parenthesis are for reference only. Controlling dimensions are in inches. Dimensioning and tolerancing per ASME Y14.5M.
2. This drawing is subject to change without notice.
3. This dimension does not include mold flash, protrusions, or gate burrs. Mold flash, protrusions, or gate burrs shall not exceed  $.006$  [0.15] per side.
4. This dimension does not include interlead flash.
5. Reference JEDEC registration MS-012, variation AA.

# EXAMPLE BOARD LAYOUT

D0008A

SOIC - 1.75 mm max height

SMALL OUTLINE INTEGRATED CIRCUIT



LAND PATTERN EXAMPLE  
EXPOSED METAL SHOWN  
SCALE:8X



SOLDER MASK DETAILS

4214825/C 02/2019

NOTES: (continued)

- 6. Publication IPC-7351 may have alternate designs.
- 7. Solder mask tolerances between and around signal pads can vary based on board fabrication site.

# EXAMPLE STENCIL DESIGN

D0008A

SOIC - 1.75 mm max height

SMALL OUTLINE INTEGRATED CIRCUIT



SOLDER PASTE EXAMPLE  
BASED ON .005 INCH [0.125 MM] THICK STENCIL  
SCALE:8X

4214825/C 02/2019

NOTES: (continued)

8. Laser cutting apertures with trapezoidal walls and rounded corners may offer better paste release. IPC-7525 may have alternate design recommendations.
9. Board assembly site may have different recommendations for stencil design.

## IMPORTANT NOTICE AND DISCLAIMER

TI PROVIDES TECHNICAL AND RELIABILITY DATA (INCLUDING DATA SHEETS), DESIGN RESOURCES (INCLUDING REFERENCE DESIGNS), APPLICATION OR OTHER DESIGN ADVICE, WEB TOOLS, SAFETY INFORMATION, AND OTHER RESOURCES "AS IS" AND WITH ALL FAULTS, AND DISCLAIMS ALL WARRANTIES, EXPRESS AND IMPLIED, INCLUDING WITHOUT LIMITATION ANY IMPLIED WARRANTIES OF MERCHANTABILITY, FITNESS FOR A PARTICULAR PURPOSE OR NON-INFRINGEMENT OF THIRD PARTY INTELLECTUAL PROPERTY RIGHTS.

These resources are intended for skilled developers designing with TI products. You are solely responsible for (1) selecting the appropriate TI products for your application, (2) designing, validating and testing your application, and (3) ensuring your application meets applicable standards, and any other safety, security, regulatory or other requirements.

These resources are subject to change without notice. TI grants you permission to use these resources only for development of an application that uses the TI products described in the resource. Other reproduction and display of these resources is prohibited. No license is granted to any other TI intellectual property right or to any third party intellectual property right. TI disclaims responsibility for, and you will fully indemnify TI and its representatives against, any claims, damages, costs, losses, and liabilities arising out of your use of these resources.

TI's products are provided subject to [TI's Terms of Sale](#) or other applicable terms available either on [ti.com](https://www.ti.com) or provided in conjunction with such TI products. TI's provision of these resources does not expand or otherwise alter TI's applicable warranties or warranty disclaimers for TI products.

TI objects to and rejects any additional or different terms you may have proposed.

Mailing Address: Texas Instruments, Post Office Box 655303, Dallas, Texas 75265  
Copyright © 2023, Texas Instruments Incorporated