



## 10DCPW\_4 series

10Watt - Single Output DC-DC Converter -  
Ultra Wide Input Range - High Isolated & Regulated

## DC-DC Converter 10 Watt

- ⊕ Ultra-wide input voltage range: 200 ~ 1500VDC
- ⊕ Operating temperature: -40°C ~ 70°C
- ⊕ 4000VAC isolation voltage
- ⊕ High efficiency
- ⊕ Low ripple & noise
- ⊕ Short circuit protection (SCP)
- ⊕ Input under voltage, over voltage, reverse voltage and over current protection
- ⊕ High reliability, long life,
- ⊕ 3 years warranty
- ⊕ UL 1741/CSA-C22.2
- ⊕ No.107.1, EN62109 approval (pending)
- ⊕ DIN-Rail package products
- ⊕ Built-in high-voltage fuse
- ⊕ RoHS and EMC filter module



The 10DCPW\_4 series is a 200-1500 VDC ultra wide input voltage regulated DC-DC converter, which has advantages such as high efficiency, high reliability and high safety isolation. The series products are widely used in industries such as photovoltaic power generation and high voltage frequency conversion, provide a stable operating voltage for the load device, Its multiple protection features can enhance the safety performance of the module power supply and the load under abnormal working conditions.

Common specifications	
Short circuit protection:	Continuous, automatic recovery
Temperature rise at full load:	25°C MAX (Ta= 25°C, 100% load)
Cooling:	Free air convection
Operation temperature range:	-40°C~+70°C
Storage temperature range:	-40°C ~+85°C
Case temperature:	90°C MAX
Welding temperature:	Wave-soldering: 260± 5°C; time:5~10s Manual-welding: 360± 10°C; time:3~5s
Power derating:	+50°C~+70°C: 10DCPW/15DCPW: 1.5%/°C MIN 40DCPW: 2.5%/°C MIN -40°C~0°C: 10DCPW/15DCPW: 0.75%/°C MIN 15DCPW_24S4/40DCPW: 1.5%/°C MIN
Case Material Grade:	Black flame-retardant and heat-resistant plastic (UL94-V0)
Switching frequency:	65kHz
Storage humidity range:	< 95%
Temperature coefficient:	±0.02%/°C MAX
MTBF (MIL-HDBK-217F@25°C):	>300,000 hours
Weight:	10W/15W output:300g 40W output:410g

Input specifications					
Item	Test condition	Min	Typ	Max	Units
Input voltage range		200		1500	VDC
Input current	200VDC input				
	• 10W/15W output			120	mA
	• 40W output			320	mA
	800VDC input				
• 10W/15W output				30	mA
	• 40W output			80	mA
1500VDC input					
	• 10W/15W output			16	mA
	• 40W output			42	mA
Inrush current	• 200VDC		30		A
	• 800VDC		80		A
	• 1500VDC		150		A
Under-voltage protection	Under voltage protection range: 170~185V Under voltage release range:180~195V				
External input fuse	15A/1500VDC				
Hot plug	Unavailable				

Output specifications					
Item	Test condition	Min	Typ	Max	Units
Output voltage accuracy			±2		%
Line regulation	Full load		±1		%
Load regulation	0%-100% load		±1		%
Ripple & Noise*	20MHz Bandwidth		150	300	mV
Over current protection	120%~320%Io, self-recovery				
Over voltage protection	• 5V output voltage				• (Feedback-clamp) Voltage limited < 8V
	• 12V/15V output voltage				• (Feedback-clamp) Voltage limited < 20V
	• 24V output voltage				• (Feedback-clamp) Voltage limited < 30V
Min. load	0%-100% load	0			%
Delay time**	200~1500VDC			2	s

\* Test ripple and noise by "parallel cable" method. Test efficiency at normal temperature and input voltage is 200VDC.

\*\* Delay Time test condition: Full input voltage range, full output load range (The cooling time between Input power-off and the next input Power-on is bigger than 15s).

Isolation specifications					
Item	Test condition	Min	Typ	Max	Units
Isolation voltage	Tested for 1 minute	4000			VAC
Isolation resistance	Test at 500VDC	100			MΩ

### Example:

#### 10DCPW\_05S4

10 = 10Watt; DC = DIP Case; P = Photovoltaik; W = Wide input;  
05 = 5Vout; S = Single output; 4 = 4kVAC isolation

## 10DCPW\_4 series

10Watt - Single Output DC-DC Converter -  
Ultra Wide Input Range - High Isolated & Regulated

### EMC specifications

EMI	CE	CISPR22/EN55022	CLASS A (refer to EMC recommended circuit)
EMI	RE	CISPR22/EN55022	CLASS A (refer to EMC recommended circuit)
EMS	ESD	IEC/EN61000-4-2	Contact ±6KV/Air ±8KV perf. Criteria B
EMS	RS	IEC/EN61000-4-3	10V/m perf. Criteria A
EMS	EFT	IEC/EN61000-4-4	±2KV perf. Criteria B (refer to recommended circuit)
EMS	Surge	IEC/EN61000-4-5	line to line ±1KV perf. Criteria B (refer to recommended circuit)
EMS	CS	IEC/EN61000-4-6	10 Vr.m.s perf. Criteria A
EMS	PFM	IEC/EN61000-4-8	10A/m perf. Criteria A

## Product Selection Guide

Part Number	Power [W]	Nominal Output [V; Vo]	Current Output [mA; Io]	Capacitive load [μF, Max.]	Ripple & Noise [mV, typ.]	Efficiency [%, max]
10DCPW_0554	10	5	2000	6000	150	64

Note: \*Part No. with suffix of "DR" means: DIN-Rail mounting (e.g.: 10DCPW\_0554DR means DIN-Rail mounting).

## Typical characteristics

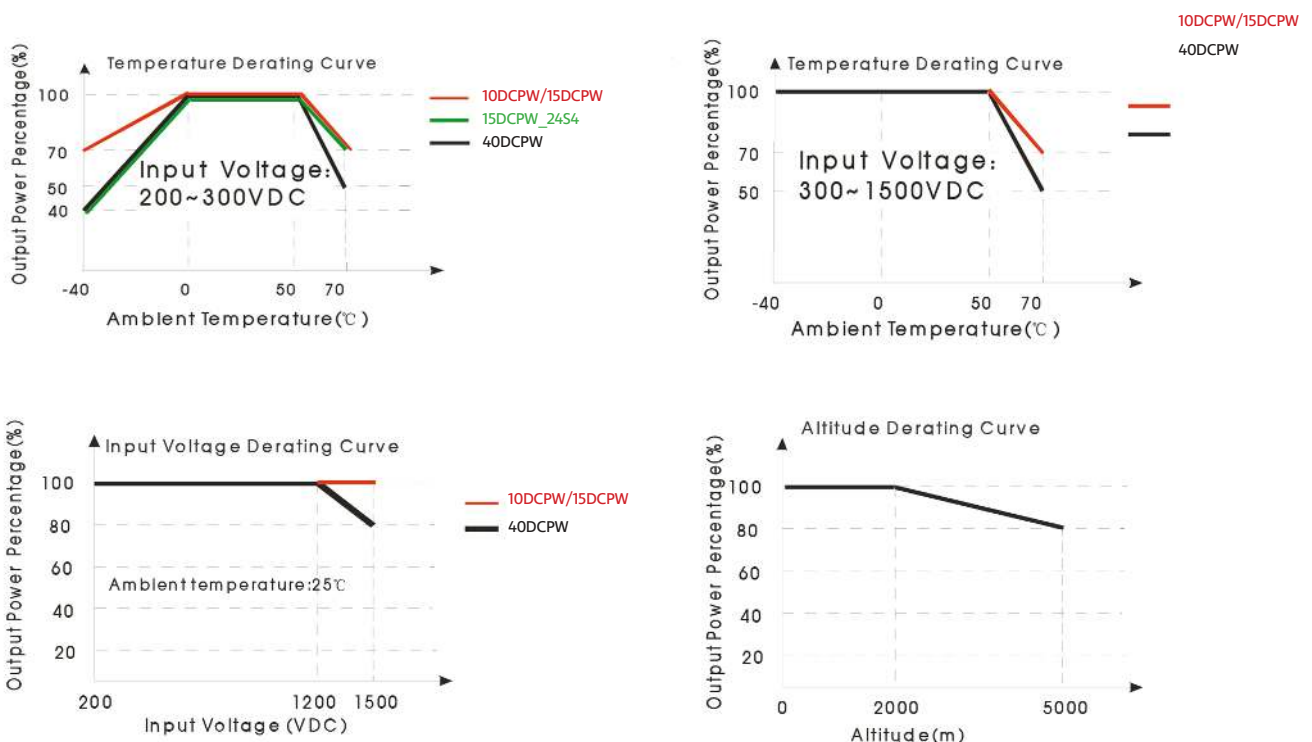

### Note:

1. For the 40DCPWxx54, input voltage should be derated based on temperature derating when it is 1200~1500VDC;
2. For the 10-40DCPW, altitude should be derated based on temperature derating when it is 2000~5000m;
3. This product is suitable for use in natural air cooling environments, if in a closed environment, please contact our company's FAE.

## 10DCPW\_4 series

10Watt - Single Output DC-DC Converter -  
Ultra Wide Input Range - High Isolated & Regulated

### Typical application circuit

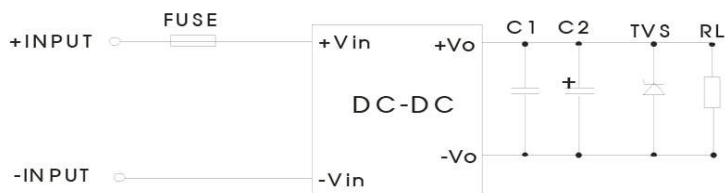

Model	C1 (μF)	C2 (μF)	TVS
10DCPW_05S4	1	120	SMBJ7.0A
15DCPW_12S4	1	120	SMBJ20A
15DCPW_15S4	1	120	SMBJ20A
15DCPW_24S4	1	68	SMBJ30A
40DCPW_12S4	1	120	SMBJ20A
40DCPW_15S4	1	120	SMBJ20A
40DCPW_24S4	1	68	SMBJ30A

#### Note:

Output filtering capacitor C2 is an electrolytic capacitor, it is recommended to apply electrolytic capacitor with high frequency and low resistance. For capacitance and current of capacitor please refer to manufacture's datasheet. Capacitance withstand voltage derating should be 80% or above. C1 is a eramic capacitor, which is used to filter high-frequency noise. TVS is a recommended component to protect post-circuits if converter fails.

### EMC solution-recommended circuit

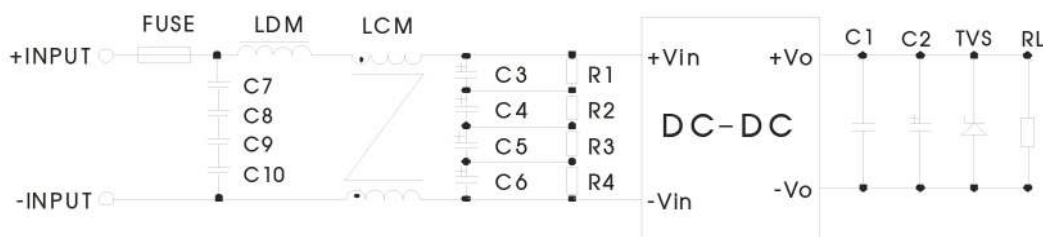

EMC application circuit with higher requirements  
(The output circuit parameters show in typical application)

Element model	Recommend value
C7, C8, C9, C10	104K/275VAC
C1, C2, C3, C4	47μF/450V
R1, R2, R3, R4	1MΩ/2W
LDM	330uH/1A
LCM	7mH/1A
FUSE	3.15A, slow fusing, necessary

## 10DCPW\_4 series

10Watt - Single Output DC-DC Converter -  
Ultra Wide Input Range - High Isolated & Regulated

### Mechanical dimensions and recommended layout

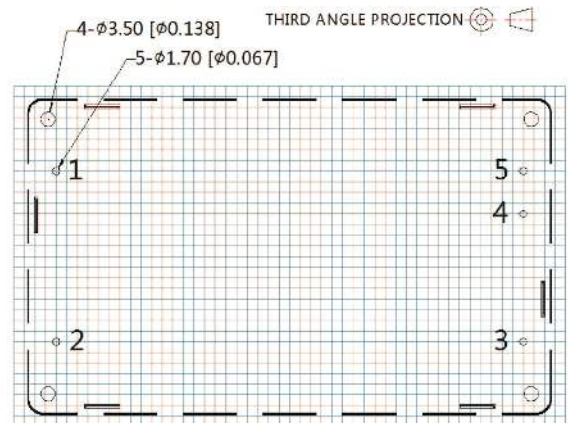
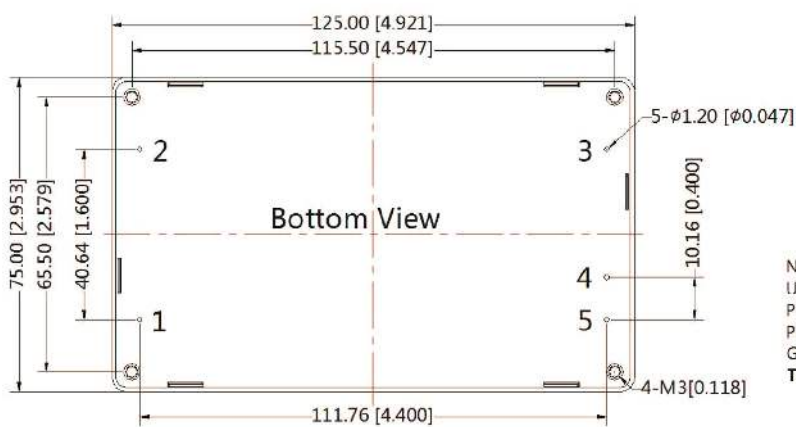
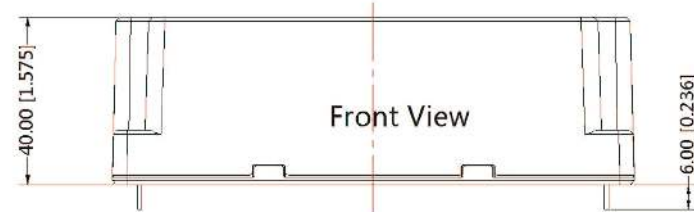

Note : Grid 2.54\*2.54mm

Pin-Out	
Pin	Function
1	-Vin
2	+Vin
3	NC
4	-Vo
5	+Vo

Note:

Unit:mm[inch]

Pin diameter tolerances: $\pm 0.10$  [ $\pm 0.004$ ]

Pin tolerances(H): $\pm 1.50$  [ $\pm 0.059$ ]

General tolerances: $\pm 0.50$  [ $\pm 0.020$ ]

**This serie of products need to fix screws in a bad vibration environment**

## 10DCPW\_4 series

10Watt - Single Output DC-DC Converter -  
Ultra Wide Input Range - High Isolated & Regulated

### DIN rail mounting

THIRD ANGLE PROJECTION 

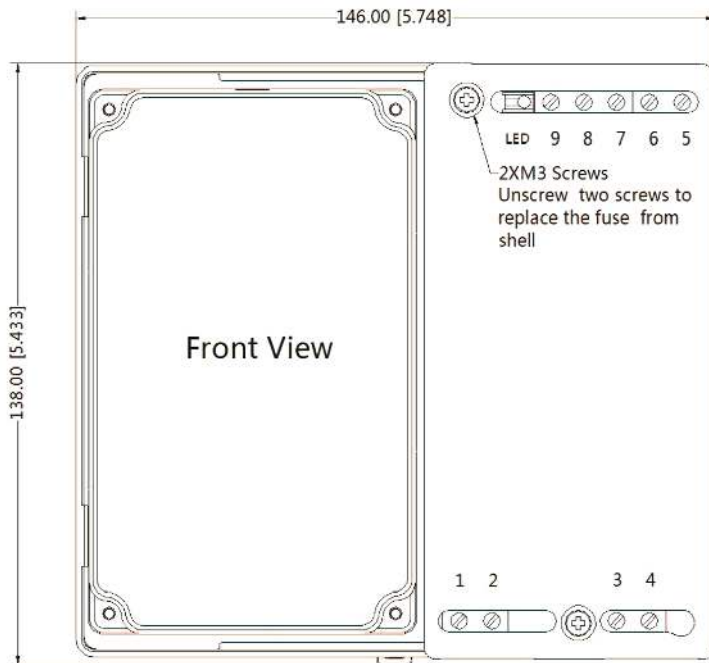

Pin-Out	
Pin	Function
1	-Vin
2	-Vin
3	+Vin
4	+Vin
5	+Vo
6	-Vo
7	NC
8	NC
9	NC

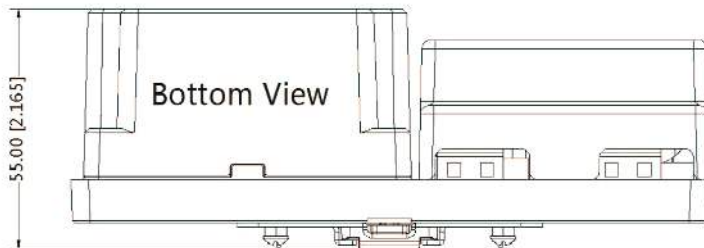

Note:  
Unit:mm[inch]  
Installed on DIN rail TS35  
Wire range : 24~12 AWG  
General tolerances:±1.00[±0.039]

Din-rail metal holder needs to be grounded

#### Note:

1. Unless otherwise specified, all specifications above are measured at rated input voltage and rated output load, TA = 25°C, humidity < 75%;
2. All specifications stated in this datasheet are subject to the above listed models only. For specifications of non-standard models, please contact our technical support team.
3. Prohibit the use of the washer as water easily corrosive substances cleaning products shell, In order to avoid damage product shell;
4. In order to improve the conversion efficiency, when the module is working under high pressure, the module may have certain audio noise, but does not affect the reliability of the product;
5. The performance indexes of the product models listed in this manual are as above, but some indexes of non- standard model products will exceed the abovementioned requirements, and please directly contact our technician for specific information;
6. We can provide product customization service;
7. Specifications of this product are subject to changes without prior notice.